



www.monoequip.com

Enter **Serial No.** here. _____

In the event of an enquiry please quote this serial number.



DELTA DEPOSITOR

OPERATING AND MAINTENANCE MANUAL

The use of templates and/or accessories not produced or supplied by MONO Equipment will invalidate the machine's warranty

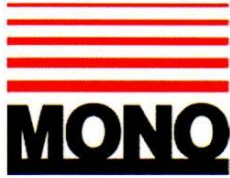

DECLARATION OF CONFORMITY

We hereby declare that this machine complies with the essential health and safety requirements of :-

- The Machinery Directive 2006 / 42 / EC
- The Low voltage Directive 2014 / 35/ EC
- The requirements of the Electromagnetic Compatibility Directive 2004 / 108EC, 91 / 263 / EEC, 92 / 31 / EEC
Incorporating standards
EN55014-1:2006+A1:2009+A2:2011
EN55014-2:1997+A1:2001+A2:2008
- The General Safety of Machinery and food processing Standards applicable
- Materials and Articles intended to come into contact with food Regulation (EC) No. 1935 / 2004
- Good manufacturing practice for materials intended to come into contact with food – Regulation (EC) No.2023/2006

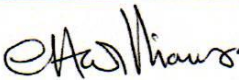
Signed			
G.A.Williams – Quality Manager			
Date			
Machine FG Code.		Machine Serial No.	

A technical construction file for this machine is retained at the following address:

MONO EQUIPMENT
Queensway,
Swansea West Industrial Park,
Swansea
SA5 4EB
UK

MONO EQUIPMENT is a business name of **AFE GROUP Ltd**
Registered in England No.3872673 VAT registration No.923428136

Registered office: Unit 9, Bryggen Road,
North Lynn Industrial Estate,
Kings Lynn,
Norfolk,
PE30 2HZ

SAFETY SYMBOLS

The following safety symbols are used throughout this product documentation. Before using your new equipment, read the instruction manual carefully and pay special attention to information marked with the following symbols.



WARNING

Indicates a hazardous situation which, if not avoided, will result in death or serious injury.



WARNING

Indicates a hazardous situation which, if not avoided, will result in electric shock.



CAUTION

Indicates a hazardous situation which, if not avoided, will result in minor or moderate injury.

ELECTRICAL SAFETY AND ADVICE REGARDING SUPPLEMENTARY ELECTRICAL PROTECTION:

Commercial bakeries, kitchens and foodservice areas are environments where electrical appliances may be located close to liquids or operate in and around damp conditions or where restricted movement for installation and service is evident.

The installation and periodic inspection of the appliance should only be undertaken by a qualified, skilled and competent electrician, and connected to the correct supply suitable for the load as stipulated by the appliance data label.

The electrical installation and connections should meet the necessary requirements of the local electrical wiring regulations and any electrical safety guidelines.

We Recommend:

- Supplementary electrical protection with the use of a residual current device (RCD)
- Fixed wiring appliances incorporate a locally situated switch disconnecter to connect to, which is easily accessible for switching off and safe isolation purposes. The switch disconnecter must meet the specification requirements of IEC 60947.



The supply to this machine must be protected by a **30mA RCD**

Failure to adhere to the cleaning and maintenance instructions detailed in this manual could affect the warranty of this machine.



□ **DISPOSAL**

CARE SHOULD BE TAKEN WHEN THE MACHINE COMES TO THE END OF ITS WORKING LIFE. ALL PARTS SHOULD BE DISPOSED OF IN THE APPROPRIATE PLACE, EITHER BY RECYCLING OR OTHER MEANS OF DISPOSAL THAT COMPLIES WITH LOCAL REGULATIONS.

(IN UK, ENVIRONMENTAL PROTECTION ACT 1990 APPLIES)

The use of templates and/or accessories not produced or supplied by MONO Equipment will invalidate the machine's warranty

INDEX

1.0 INTRODUCTION

2.0 DIMENSIONS

3.0 SPECIFICATIONS

4.0 SAFETY

5.0 INSTALLATION

6.0 ISOLATION

7.0 CLEANING INSTRUCTIONS

Between mix changes

Table removal and cleaning

8.0 OPERATING CONDITIONS

9.0 OPERATING INSTRUCTION

Fitting the hopper

Fitting a non-rotary template

Fitting a rotary template

10.0 CONTROL PANEL (Key diagram)

11.0 DESCRIPTION OF CONTROL PANEL FUNCTIONS

12.0 OPERATIONAL CONTROLS

Start button

Stop button

Prime button

Auto button

Manual button

13.0 PREPERATION FOR OPERATION

14.0 MACHINE / PRODUCT PROGRAMMING (see separate manual)

15.0 MAINTENANCE

1. Resettable miniature contact breakers

2. Lubrication

3. Air filter replacement

16.0 SPARES AND SERVICE

17.0 RECOMMENDED SPARES LISTS

1. Electrical

2. Base machine spares

3. Table spares

4. Hopper spares

18.0 ELECTRICAL DIAGRAMS

1.0 INTRODUCTION

MONO's DELTA depositor is designed for ease of use to produce a wide range of confectionery products. Its exceptional accuracy, repeatability, versatility and user friendly approach lends itself to high volume production and to where product variety is required.

Product creation requires programming of the **DELTA's** controller via its menu driven interface using the key switch type keypad and LCD screen situated on the front of the machine. Product programs can be stored into the controller's memory for future retrieval – each program requiring unique identification using alpha and/or numeric characters. Subsequent deletion of created programs is only via a password-protected screen.

The **DELTA** has four axes of controlled movement; deposit pump, deposit head raise/lower, tray horizontal travel and nozzle rotation. All four axes or any combination of the four can be programmed to operate simultaneously, in forward or reverse direction, to produce the product shape required.

Mechanically, the **DELTA** is configured with the depositing head capable of vertical movement and the tray conveyor in a fixed height position. This combination permits the siting of the **DELTA** over existing conveyor production lines with minimal modification.

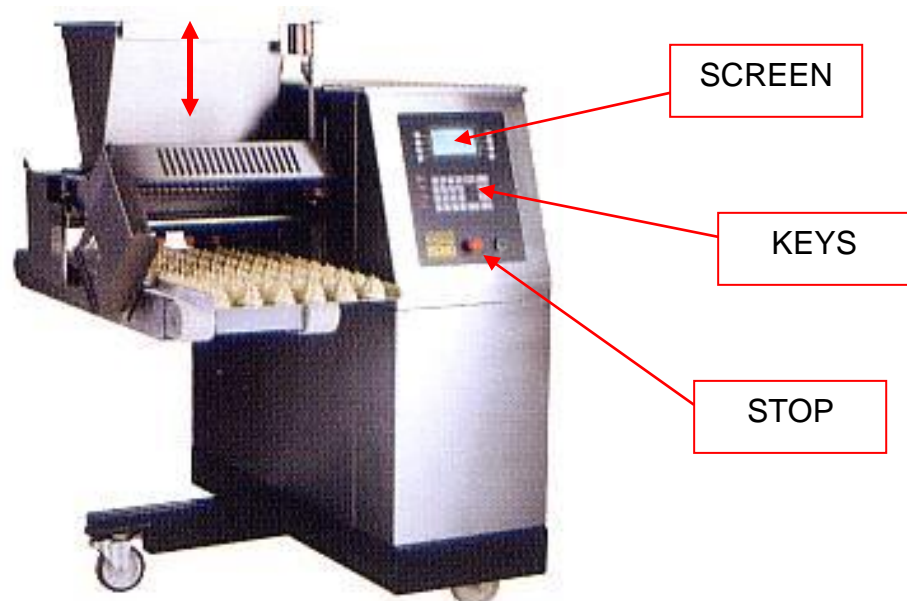

In order to achieve smooth production and optimum performance, it is recommended that the information given in this manual be studied before any operation is carried out.

2.0 DIMENSIONS

MAX WIDTH = 1193mm (580mm HOPPER)
= 1063mm (450mm HOPPER)
= 1013mm (400mm HOPPER)

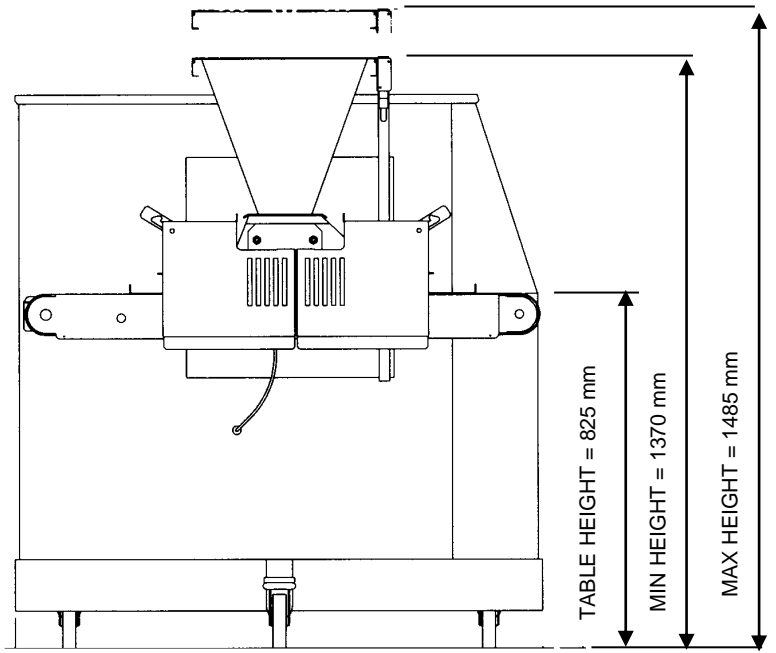
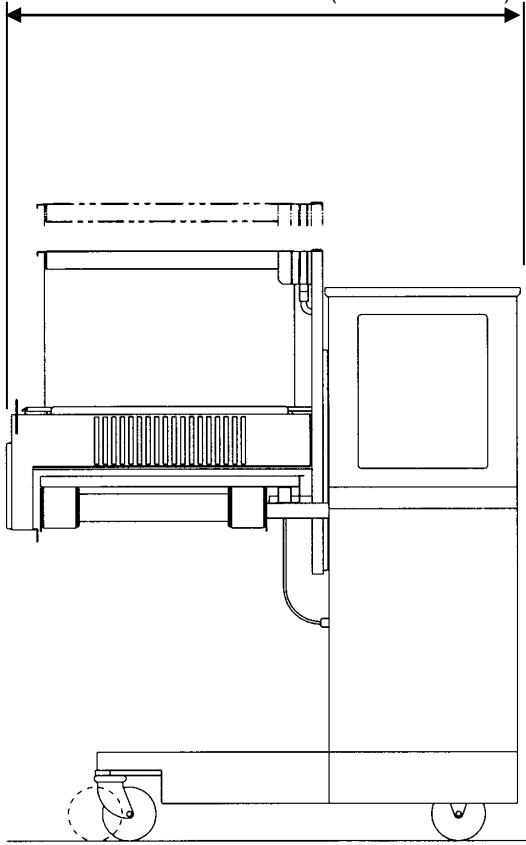

TABLE HEIGHT = 825 mm
MIN HEIGHT = 1370 mm
MAX HEIGHT = 1485 mm

MAX LENGTH = 1225



As it is our policy to improve our machines continuously, we reserve the right to change specifications without prior notice.

3.0 SPECIFICATIONS (soft dough)

MODEL (Nominal Hopper Width)	40	45	58
WEIGHT (Kg)	388	390	396
Maximum Deposit Rate (litre/minute)	26	30	40
Maximum Single Deposit (litre)	8.5	9.5	12
Standard Hopper Capacity (litre)	36	41	53

Maximum Vertical Travel : 110mm

Minimum Distance Between Trays : 50mm

POWER : 2.5 Kw SINGLE PHASE FUSED AT 20A.
Anti-surge or 20A type D MCB.



The supply to this machine must be protected by a **30mA RCD**

Electronics : All microprocessor controlled

Noise Level : Less than 85dB

The use of templates and/or accessories not produced or supplied by MONO Equipment will invalidate the machine's warranty

NOTE

The minimum deposit that can be made depends on several factors,

- *Recipe - mixing method - template size and deposit speed.*

As a guide the following is the minimum that should be attempted.

macaroons — 6g
meringues — 3g,
choux paste — 5g
Viennese — 4g,
sponge drops — 4g

*However, consult **Mono Equipment** if intended product falls outside the above general machine specification to determine the **DELTA's** exact capabilities with any specific product.*

As it is our policy to improve our machines continuously,
we reserve the right to change specifications without prior notice.

4.0 SAFETY



- 1 Never use a machine in a **faulty condition** and always report any damage.
- 2 Only **trained engineers** may remove any part from this machine that requires a tool to do so.
- 3 Always **ensure hands are dry** before touching any electrical appliance (including cable, switch and plug).
- 4 All operatives **must be fully trained**.
- 5 People undergoing training on the machine must be **under direct supervision**.
- 6 **Do not operate the machine with any panels or guards removed**.
- 7 **No loose clothing or jewellery** should be worn while operating the machine.
- 8 Switch off power at the mains isolator when machine is not in use and before carrying out any cleaning or maintenance.



ALL CLEANING AND MAINTENANCE OPERATIONS MUST BE MADE WITH MACHINE DISCONNECTED FROM THE POWER SUPPLY.

- 9 The bakery manager or the bakery supervisor must carry out daily safety checks on the machine.
- 10 Do not operate machine without hopper template fitted correctly.

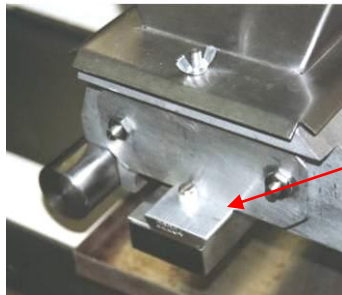

TEMPLATE CORRECTLY FITTED TO HOPPER

5.0 INSTALLATION

- 1 Ensure that the depositor is connected to the correct electric supply as specified on the serial number plate on the rear of the machine.
- 2 Ensure that the correct fuse rating is fitted in the electrical supply to the DELTA a 13A single phase supply fused at 20A anti-surge or 20A type D MCB is required.

6.0 ISOLATION

- 1 In an emergency, switch off at the mains wall isolator, or the machine's emergency stop button. To release the emergency stop button, turn clockwise.

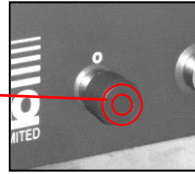

**EMERGENCY
STOP BUTTON**

7.0 CLEANING INSTRUCTIONS

NOTE:

-Cleaning must be carried out by fully trained personnel only.



-Isolate machine from mains supply before carrying out any cleaning.

-Do not steam clean or use a jet of water,
except in the rotary template drive gear compartment

All the outer surfaces of the machine should be wiped over with warm soapy water.
Do not use any form of caustic detergent or abrasive.

BETWEEN PRODUCT MIX CHANGES

- 1 The hopper, hopper pump, template, nozzles etc should be removed from the machine and dismantled for thorough cleaning.
- 2 Prior to removing the hopper or template, the guards must be hinged up and propped into the appropriate position.
- 3 Slacken template clamp strip nuts and remove fitted template from hopper pump assembly by sliding out to avoid subsequent damage.
- 4 To reduce weight and bulk, separate and remove hopper body from hopper pump assembly whilst still on the machine. Unscrew the nuts holding the hopper body to the hopper pump to reveal the 'O' sealing ring. Ensure seal is not damaged during cleaning.
- 5 Unscrew hopper retaining pin and remove hopper pump assembly from machine to separate cleaning area.

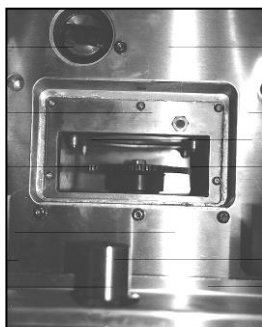

**ROTARY TEMPLATE
DRIVE**



**FRONT AND REAR GUARDS
HINGED UP**

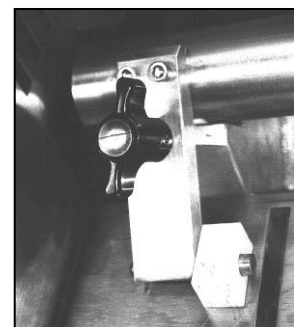

HOPPER RETAINING PIN



CAUTION SHOULD BE TAKEN WHEN REMOVING HOPPER ASSEMBLY AS WEIGHT EXCEEDS 25KGS.

- 6 Unscrew the nuts holding the pump end cap to the hopper. Ensure that the nuts are placed where they will not be lost.
- 7 Withdraw the end cap with the pump gears, if still attached. Ensure that the 'O' sealing ring on the inside of the endplate is not damaged during cleaning.

NOTE: Use only warm soapy water to clean these parts that should be rinsed and thoroughly dried before reassembly. The greatest care must be taken not to drop the hopper, or leave any components in the hopper. After washing, the component parts should be allowed to cool before attempting reassembly.

- 8 Reassembly is reversal of above procedure.

TABLE REMOVAL AND CLEANING

- 1 Removal of the table from the machine for cleaning is not necessary, however, if required, unscrew the two securing screws from the side of the table and slide table off support bars - the drive shaft will disengage from its coupling as the table is removed.

To replace, follow reverse procedure ensuring drive shaft engages properly with its coupling.

- 2 In normal use clean the table's external surfaces and belts with warm soapy water and rinse and thoroughly dry before use.
- 3 The table's conveyor belts can be disengaged from their drive rollers by slackening the adjusting screws on the underside of the table. However, for belt replacement first remove the table from machine as in 1 above.

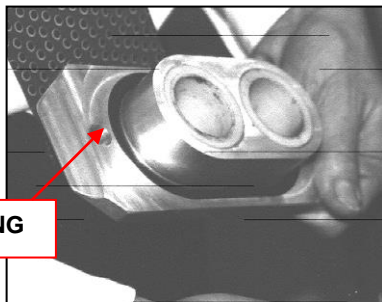

END CAP O-RING

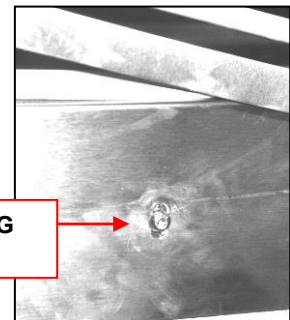

TABLE RETAINING SCREWS

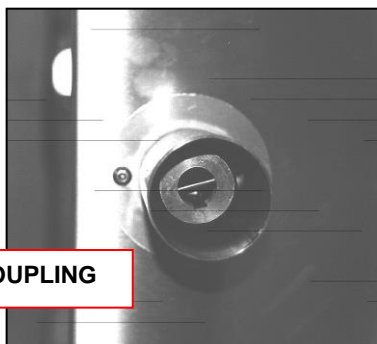
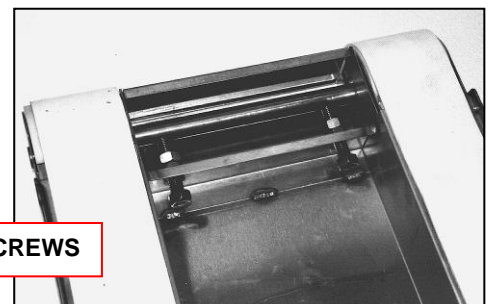

TABLE DRIVE COUPLING



BOLT ADJUSTING SCREWS

8.0 OPERATING CONDITIONS

Make sure the depositor is used on a level floor to achieve best results. Ensure flat trays of consistent length, width, material and edge dimensions are used to obtain the best product results and consistent operating from the **DELTA**.

9.0 OPERATING INSTRUCTIONS

FITTING THE HOPPER

The use of templates and/or accessories not produced or supplied by MONO Equipment will invalidate the machine's warranty



CAUTION SHOULD BE TAKEN WHEN FITTING HOPPER PUMP AS WEIGHT EXCEEDS 25KGS.

- 1 Hinge up front and rear hopper guards and prop up.
To reduce weight and bulk, fit the complete hopper assembly in two stages
- first the hopper pump assembly, then the hopper body with its detachable top guard
- 2 Align hopper pump drive gear with drive shaft and slide hopper on support bars until fully up against bulkhead. Screw in hopper retaining screw once the hopper is positioned correctly.

DO NOT OPERATE MACHINE WITHOUT TEMPLATE FITTED.

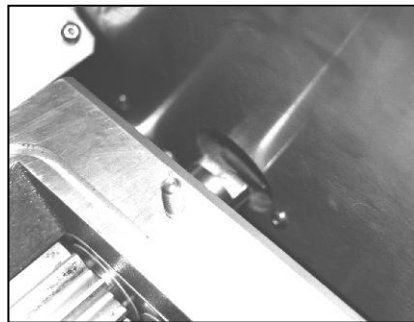

Hopper pump drive shaft alignment

FITTING A NON-ROTARY TEMPLATE

- 1 Hinge up front and rear hopper guards and prop up.
- 2 Select template and nozzles required.
- 3 Screw nozzles into threaded nozzle tube on templates.
- 4 Slide template into matching recess at base of hopper pump until the stop engages.
- 5 Tighten nuts on clamp strip on underside of hopper pump to secure template. Leakage of mix will occur if the nuts are not securely tightened.
- 6 Lower front and rear hopper guards.

FITTING OF ROTARY TEMPLATES

These units are used for the manufacture of circular products.

The straight rotary holder(s) are used, for whirls.

Offset rotary holder(s) are used for such products as meringue rings.

- 1 Hinge and prop up front and rear hopper guards
- 2 Select template, nozzle holder and nozzle required.
- 3 Screw nozzles into offset or straight rotary holder.
- 4 Insert nozzle holder into template ensuring that they are pushed fully into seatings.
- 5 Slide template into matching recess at base of hopper pump until gear teeth mesh (i.e. stop on template abutting hopper end cap).

If gear teeth of template fail to mesh at first attempt, lower front and rear hopper guards and press start. To rotate the drive gear press -  then the green button (14).

Retry full engagement of template after re-hinging and popping up front and rear hopper guards to gain access.

- 6 Tighten nuts on underside of hopper to secure template. Leakage of mix will occur if the nuts are not securely tightened.
- 7 If offset-nozzle holder has been fitted to template check alignment of all nozzles with each other and with axis of template (this may be critical for some products and / or to avoid collision of nozzle holders whilst rotating). Adjust position by twisting holder in its template tube.
- 8 Lower front and rear hopper guards.

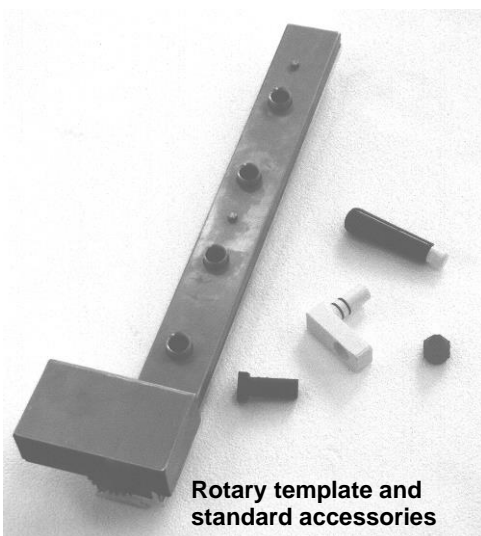

Rotary template and standard accessories

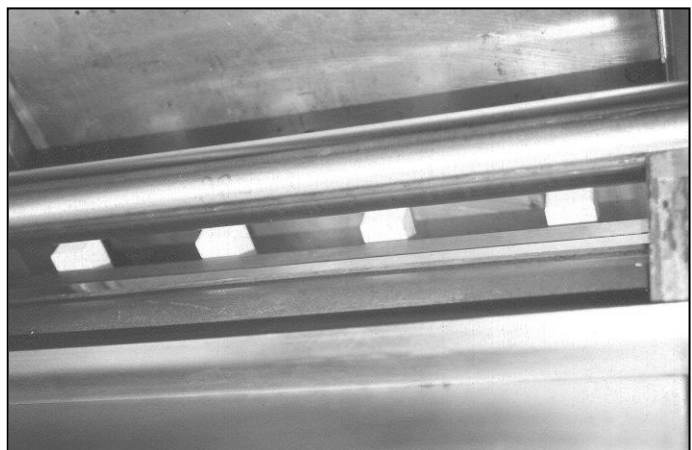

Alignment of offset holders in rotary template

10.0 DELTA CONTROL PANEL

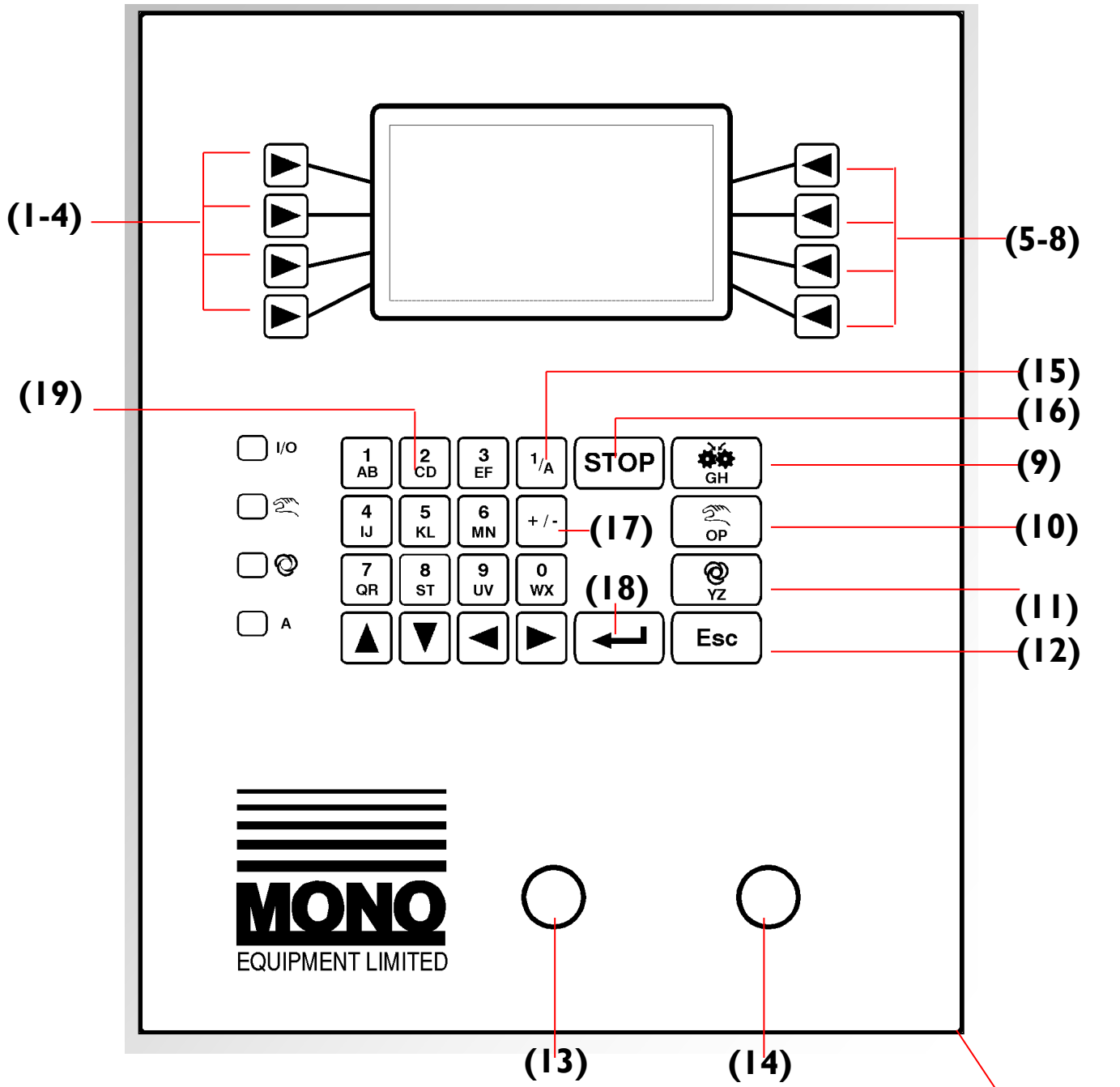

Fig. 10. DELTA Control panel



11.0 DESCRIPTION OF CONTROL PANEL – KEY FUNCTIONS

<u>DRAWING REF.</u>	<u>FUNCTION</u>	<u>DESCRIPTION</u>
1 - 8	FUNCTION KEYS	For the selection of screen menu options and to start pop up menus
9	PRIME	<p>This button activates the hopper pump for as long as it is depressed provided either edit/create or run menus are on screen, and all safety guards are properly closed.</p> <p>It fulfils four functions :-</p> <ul style="list-style-type: none">A. To prime the hopper pump and nozzles with product mix.B. Aids the engagement of the hopper drive gear into the drive shaft.C. Aids the engagement of the rotary template drive gear into the machine drive gear.D. Allows alphabetical character (G & H) entry when naming product programs for storage into memory.
10	MANUAL	<ul style="list-style-type: none">A. Runs product program for one tray only then returns tray to the operator and stops.B. Allows alphabetical character (O & P) entry when naming product programs for storage into memory.C. Allows the removal of a partially completed tray from the machine if the program is interrupted before completion of the depositing sequenceD. Press the key twice to remove tray.

11**AUTOMATIC**

Activates an automatic machine cycle so long as a tray is positioned correctly on the table. At the end of the cycle the tray conveyor will continue running to move the full tray from the machine and introduce an empty tray to the deposit start position.

NOTE>If two trays are placed too close to each other the machine will interpret this as one long continuous tray and will continue to feed both trays through the machine until a gap is detected.

This button also allows alphabetical character (Y & Z) entry when naming product programs into memory.

12**ESCAPE**

Enables exit from menus to higher-level menus and exit from current on screen operation.

13**EMERGENCY STOP**

Immediately isolates all power circuits. To release – turn clockwise.

14**START**

Applies power to the control panel. Following the pressing of either (10) “manual” or (11) “auto” (*providing that all safety guards are closed and the emergency stop button is released*) it activates all power circuits and all machine facilities,
Allows entry into “system gains” menu.

15**ALPHA / NUMERIC**

Allows the operator to toggle between alphabetical and numerical button characters. Used when putting names to stored product programs.

16**STOP**

Stop button for either the manual or automatic modes. Stops machine cycle but not power to the drives.

17**PLUS / MINUS**

Allows (when required) negative values as well as positive to be input to product programmes and machine set up parameters. The controller will not allow negative values where not appropriate.

18**ENTER**

Enters typed and displayed information into product program as well as machine set up program.

19**0 – 9 numeric keys**

Allows data entry of numerical values into product program and machine set up program. Also allows alphabetical character entry (when used in conjunction with alpha/numeric button) when naming product programs for storage into memory.

12.0 OPERATIONAL CONTROLS ---

(See fig.10)

Emergency stop button (13)

Isolates all electric circuits immediately. To release the emergency stop button, turn clockwise.

NOTE: ONLY USE IN AN EMERGENCY.

TO STOP THE MACHINE WHEN IN USE, ONLY USE STOP BUTTON (16).

Start button (14)

Activates all electric circuits. This must be pressed initially to apply power to the control panel. Either “AUTO” button (11) or “MANUAL” button (10) followed by start button (14) are then pressed to apply power to the motors and start the program.

Stop button (16)

Will stop the machine cycle immediately in either AUTOMATIC or MANUAL modes. When the machine is started again in either of these modes, it will begin to deposit at the start of a deposit cycle, no matter at what stage of the cycle the machine was stopped.

If pressed when depositing head of machine is too low to remove tray, the manual button (10) then start button (14) must be pressed in order to reset and raise head height and eject tray, which is currently on table.

Prime button (9) Then press start button (14), primes the pump gears and nozzles with product after the hopper has been loaded with mix and the hopper guards have been closed. The deposit motor will

run as long as the button is pressed. The prime button can also be used to aid the engagement of hopper gears to drive shaft and rotary template drive gear. Prime button (9) will only function in edit/create or run menu.

Auto button (11). Then press start button (14),

This automatic operation is activated by the tray sensor on the tray guide and allows the machine to be constantly fed with trays without the operator having to touch the control panel. The machine will operate when a tray is placed on the table and will stop cycling when each tray of deposit is completed. A minimum space of 50mm between trays allows for correct tray positioning. **To halt the automatic cycle press the stop button.**

Manual button (10) Then press start button (14),

initiates the machine to cycle for one tray only. On completion of the tray, it is returned to the front of the machine and stopped, and the depositing head is returned to a pre-determined height to accept the next tray, which must be subsequently placed on the table and the above procedure repeated. **To halt the manual cycle press the stop button.**

13.0 PREPARATION FOR OPERATION

- 1 Fill hopper with mix and close hopper guard. It is recommended that when heavy mixes are used, the inside of the hopper should be coated with vegetable oil; for lighter mixes such as meringue, dampen with water. The oil or water will help the mix to settle down the hopper walls and prevent air being sucked in.
- 2 Press start button.
- 3 Place a tray under the nozzles to collect initial deposits when the hopper pump is primed.
- 4 Press prime button until mix is ejected equally from all nozzles, then release prime button.
- 5 The machine is now ready for operation

14.0 MACHINE/PRODUCT PROGRAMMING

See separate controller operation manual

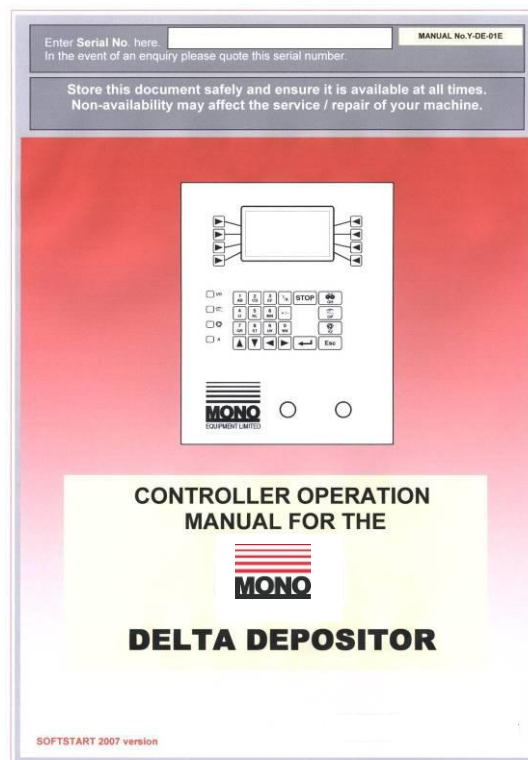

15.0 MAINTENANCE

WARNING! Isolate machine from mains supply before carrying out any maintenance procedures.

WARNING! DO NOT UNDER ANY CIRCUMSTANCES USE A WATER HOSE TO CLEAN MACHINE, EXCEPT FOR OCCASIONAL CLEANING WITHIN THE ROTARY TEMPLATE DRIVE GEAR HOUSING.

1 RESETTABLE MINIATURE CONTACT BREAKERS

These are located behind the lower removable panel on the right hand side. If a circuit breaker trips out more than once in a short period of time, contact a qualified electrician immediately.

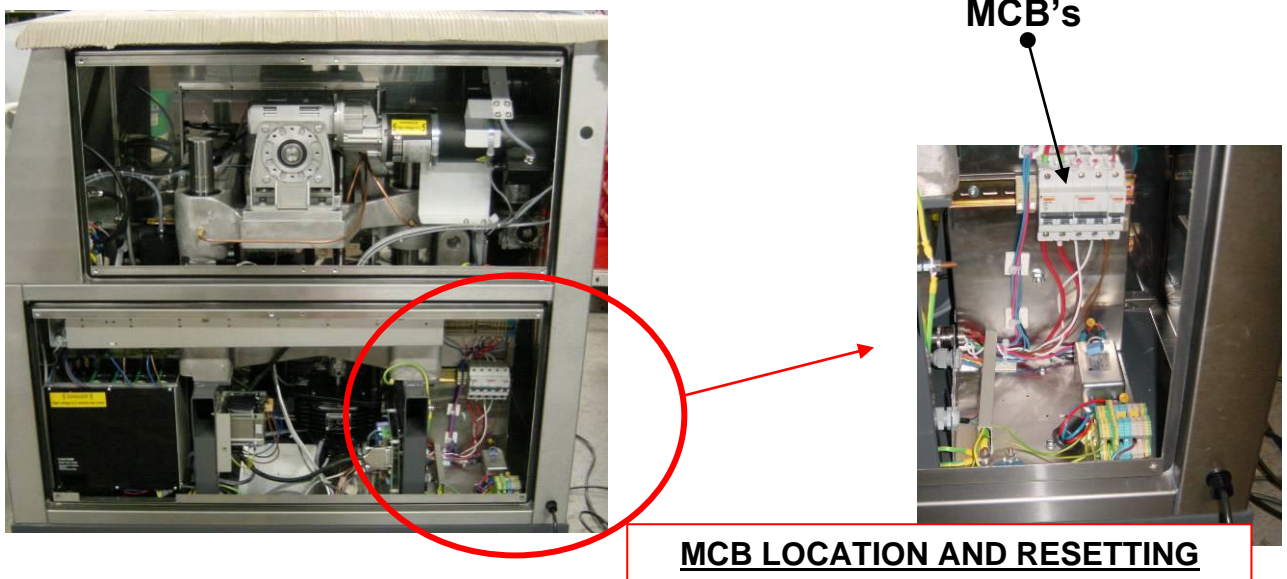

2 Lubrication

Lubrication of the **DELTA** must take place on a monthly basis. Three lubrication grease nipples are provided for this purpose.

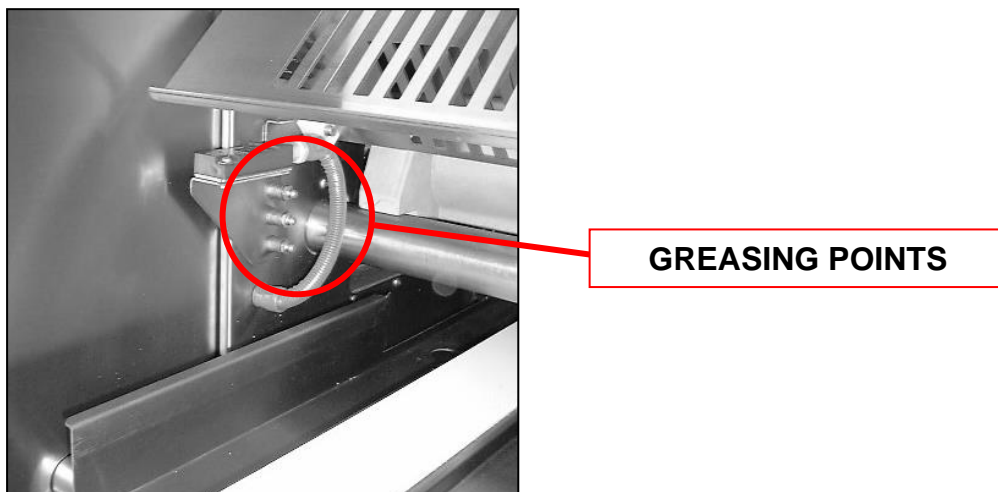

3 Air filter replacement

Replacement of the **DELTA's** air filter must take place on a 3 monthly basis, otherwise excessive restriction to air flow may result causing insufficient cooling of internal components and electronics. Removal of the air filter housing is achieved via two internal screws at the base of amplifier unit.



ONLY REMOVE 2 SCREWS SHOWN

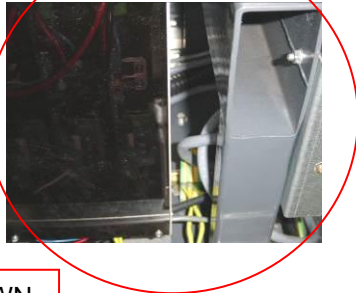

LOWER FILTER UNDERNEATH AND REMOVE TO THE RIGHT



NOTE DIRECTION OF ARROW ON NEW FILTER TO FACE UP

16.0 SPARES AND SERVICE

If a fault arises, please do not hesitate to contact the Customer Service Department, quoting the **machine serial number** on the silver information plate of the machine and on the front cover of this manual

UK SERVICE, SPARES and OVERSEAS SUPPORT:



Queensway
Swansea West Industrial Estate
Swansea.
SA5 4EB
UK

email: spares@monoequip.com
Spares Tel. +44(0)1792 564039
Web site: www.monoequip.com

Main Tel. 01792 561234
Fax. 01792 561016



17.0 DELTA DEPOSITOR RECOMMENDED SPARES LIST

1. ELECTRICAL SPARES LIST

Spares Item Description	Mono Part Number	Qty Req.per m/c
Top guard safety switch assy	073-25-02000	1
Tray sensor assy	073-25-02100	1
Hopper sensor assy	073-25-03800	1
Hopper/template type sensor assy	073-25-05000	1
Home position sensor assy	073-25-05100	1
Front guard safety switch assy	073-25-05800	1
Rear guard safety switch assy	073-25-05900	1
Transformer	B726-31-003	1
PCB-interconnect board	B728-93-019	1
Power Board – soft start	B728-93-020	1
Deposit motor servo amplifier	B739-80-001	1
Tray motor servo amplifier	B739-80-001	1
Jog motor servo amplifier	B739-80-001	1
Rotary template motor servo amplifier	B739-80-001	1
Rack for servo amplifiers	B739-09-001	1
Jog motor assy	B740-74-001	1
Deposit motor assy	B741-74-001	1
Tray motor assy	B741-74-002	1
Rotary template motor assy	B741-74-003	1
Deposit motor encoder	B742-99-001	1
Tray motor encoder	B742-99-001	1
Jog motor encoder	B742-99-001	1
Rotary template motor encoder	B742-99-001	1
Jog motor DC choke unit	B743-31-001	1
Stop button	B801-12-003	1
Start button	B801-12-029	1
Start button contact block	B801-14-001	1
Stop button contact block	B801-14-002	1
Emergency stop relay unit (if fitted)	B818-11-005	1
Jog motor temperature switch	B842-30-002	1
Varistor	B842-48-002	1
Filter unit	B773-48-002	1
Circuit breaker 110VAC supply	B872-22-002	1
Circuit breaker 18-0-18VAC supply	B872-22-075	1
Circuit breaker 72VAC supply	B872-22-094	1
Soft start interconnecting cable	B728-63-011	1

2. **BASE MACHINE SPARES LIST**

Spares Item Description	Mono Part Number	Qty Req.
Ball spline	A900-31-044	2
Flexible coupling - table drive	073-08-01400	1
Spider for ball screw coupling	A900-10-007	1
Deposit pump gearbox	A900-11-088	1
Rotary template gearbox	A900-11-077	1
Table drive gearbox	A900-11-078	1
Ball screw support unit	A900-31-045	1
Ball screw and nut	073-04-00200	1
Rotary template drive gear	073-04-00300	1
Rotary template drive shaft	073-04-00400	1
Key-rotary template gearbox	073-04-00700	1
Deposit pump drive shaft	073-04-00800	1
Disc spring	A900-19-081	16
Circlip-rotary template drive shaft	A900-01-260	1
Key-ball screw shaft	A900-01-261	1
Key-rotary template drive shaft	A900-01-262	1
Key-deposit pump drive shaft	A900-01-263	1
Self aligning ball bearing	A900-06-218	1
V-ring seal	A900-12-078	1
Shaft lip seal	A900-12-079	1
Control panel assy	073-15-00100	1
Fixed castor	A900-20-036	2
Locking swivel castor	A900-20-037	1
Air filter	A900-30-001	1

3. TABLE SPARES LIST

Table size	Spares Item Description	Mono Part Number	Qty Req.
400/450mm	Drive shaft bearing	A900-06-245	2
	Drive shaft	073-08-00900	1
	Idler shaft	073-08-01000	1
	Idler pulley	073-08-01100	2
	Drive pulley	073-08-01200	2
	Conveyor belt	A900-22-101	2
<hr/>			
580mm	Drive shaft bearing	A900-06-245	2
	Drive shaft	073-08-00902	1
	Idler shaft	073-08-01002	1
	Idler pulley	073-08-01100	2
	Drive pulley	073-08-01200	2
	Conveyor belt	A900-22-101	2

4. HOPPER SPARES LIST

Table size	Spares Item Description	Mono Part Number	Qty Req.
400mm	Template clamp strip	073-09-00400	1
	End cap - drive side	073-09-00500	1
	End cap - non drive side	073-09-00502	1
	End cap bush	073-09-00600	4
	Template clamp stud	073-09-01000	4
	End cap stud	073-09-01100	4
	Hopper stud	073-09-01200	2
	End cap O-ring	A900-12-074	2
	Hopper seal	A900-12-083	1
	Clamp strip nut	A900-04-131	4
450mm	Template clamp strip	073-09-00402	1
	End cap - drive side	073-09-00500	1
	End cap - non drive side	073-09-00502	1
	End cap bush	073-09-00600	4
	Template clamp stud	073-09-01000	4
	End cap stud	073-09-01100	4
	Hopper stud	073-09-01200	2
	End cap O-ring	A900-12-074	2
	Hopper seal	A900-12-084	1
	Clamp strip nut	A900-04-131	4
580mm	Template clamp strip	073-09-00403	1
	End cap - drive side	073-09-00500	1
	End cap - non drive side	073-09-00502	1
	End cap bush	073-09-00600	4
	Template clamp stud	073-09-01000	4
	End cap stud	073-09-01100	4
	Hopper stud	073-09-01200	2
	End cap O-ring	A900-12-074	2
	Hopper seal	A900-12-085	1
	Clamp strip nut	A900-04-131	5



18.0 ELECTRICAL DIAGRAMS

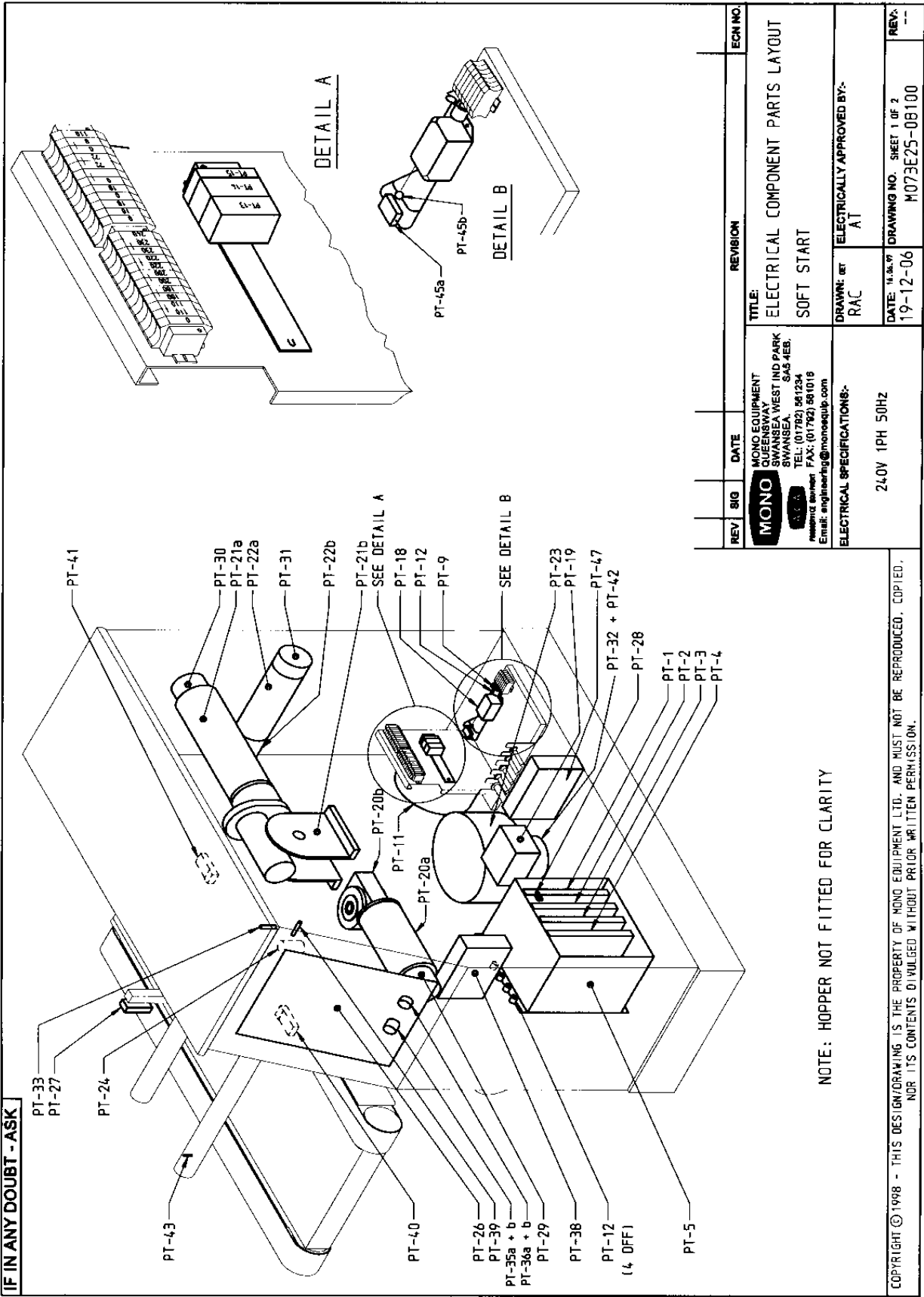

<u>DRAWING</u> PT-Ref	<u>DESCRIPTION</u>	<u>MONO</u> PART NUMBER	<u>DRAWING</u> PT-Ref	<u>DESCRIPTION</u>	<u>MONO</u> PART NUMBER
PT-1	ROTARY DRIVE MOTOR CONTROLLER	B739-80-001	PT-30	DEPOSIT MOTOR ENCODER	B742-99-001
PT-2	JOG MOTOR CONTROLLER	B739-80-001	PT-31	TRAY TRAVEL MOTOR ENCODER	B742-99-001
PT-3	TRAY TRAVEL MOTOR CONTROLLER	B739-80-001	PT-32	JOG MOTOR ENCODER	B742-99-001
PT-4	DEPOSIT MOTOR CONTROLLER	B739-80-001	PT-33	HOPPER TYPE SENSOR UNIT	B735-99-005
PT-5	CONTROLLER UNIT ENCLOSURE & POWER SUPPLY UNIT	B739-09-001	PT-35a	STOP BUTTON	B801-12-003
			PT-35b	STOP BUTTON CONTACT BLOCK	B801-14-002
			PT-36a	START BUTTON	B801-12-029
			PT-36b	START BUTTON CONTACT BLOCK	B801-14-001
PT-9	VARISTOR	B842-48-002	PT-38	INTERFACE P.C.B. UNIT	B728-93-019
PT-11	TRANSFORMER	B726-31-003	PT-39	ROTARY TEMPLATE SENSOR	B735-99-004
PT-12	FERRITE SLEEVE	B842-48-008	PT-40	FRONT SAFETY COVER SWITCH	B818-07-010
PT-13	CONTROLLER 72 VAC SUPPLY M.C.B.	B872-22-094	PT-41	REAR SAFETY COVER SWITCH	B818-07-010
PT-14	CONTROLLER 18-0-18 VAC SUPPLY M.C.B.	B872-22-075	PT-42	JOG MOTOR TEMPERATURE SWITCH	B842-30-002
PT-15	FAN POWER SUPPLY M.C.B.	B872-22-002	PT-43	HOPPER SENSOR	B735-99-006
PT-18	FILTER UNIT	B773-48-002			
PT-19	JOG MOTOR DC CHOKE UNIT	B743-31-001	PT-45a	TRANSFORMER SUPPRESSOR CAPACITOR	B900-48-003
PT-20a	ROTARY DRIVE MOTOR	B741-74-003	PT-45b	TRANSFORMER SUPPRESSOR V.D.R.	B842-48-002
PT-20b	ROTARY DRIVE MOTOR GEARBOX	A900-11-077	PT-47	POWER BOARD -SOFT START	B728-93-020
PT-21a	DEPOSIT DRIVE MOTOR	B741-74-001			
PT-21b	DEPOSIT DRIVE MOTOR GEARBOX	A900-11-088			
PT-22a	TRAY TRAVEL DRIVE MOTOR	B741-74-002			
PT-22b	TRAY TRAVEL DRIVE MOTOR GEARBOX	A900-11-007			
PT-23	JOG DRIVE MOTOR	B740-74-001			
PT-24	TRAY SENSOR UNIT	B735-99-001			
PT-26	COMPUTER DISPLAY UNIT	073-15-00100			
PT-27	HOPPER SAFETY SWITCH	B818-07-010			
PT-28	HOME POSITION OPTO SENSOR	B842-99-001			
PT-29	ROTARY MOTOR ENCODER	B742-99-001			

REV	SIG	DATE	REVISION	ECN NO.
A	JC	04-09-17	PT 18 WAS B842-48-009	DP-015-16-17
 SWANSEA IND EST. FFORESTFACH, SWANSEA, SA5 4EB. TEL: (01792) 561234 FAX: (01792) 561016 Email: 100432.505@compuserve.com				
ELECTRICAL SPECIFICATIONS:-			TITLE: COMPONENTS PARTS LAYOUT FOR DELTA DEPOSITOR USING SOFTSTART NORWIN CONTROLLERS	
DRAWN: 240v 1Ph 50HZ			DRAWN: ELECTRICALLY APPROVED BY:- BET/J/RAC AT	
DATE: 16/6/97			DRAWING NO. SH12 OF 2	
19-12-96			M073E25-08200	
			REV: A	

COPYRIGHT © 1998 - THIS DESIGN/DRAWING IS THE PROPERTY OF MONO EQUIPMENT LTD. AND MUST NOT BE REPRODUCED, COPIED, NOR ITS CONTENTS DIVULGED WITHOUT PRIOR WRITTEN PERMISSION.

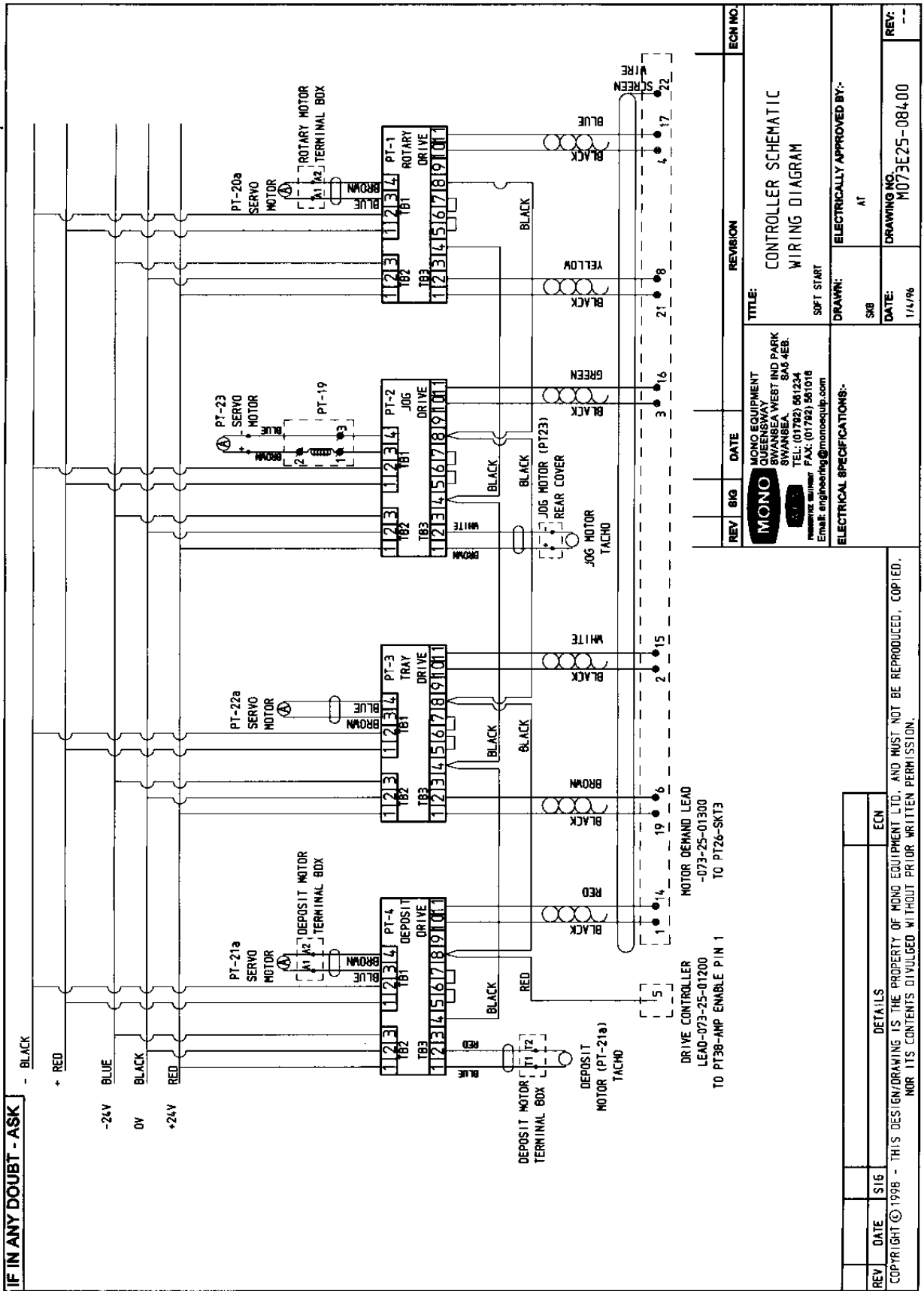

IF IN ANY DOUBT - ASK

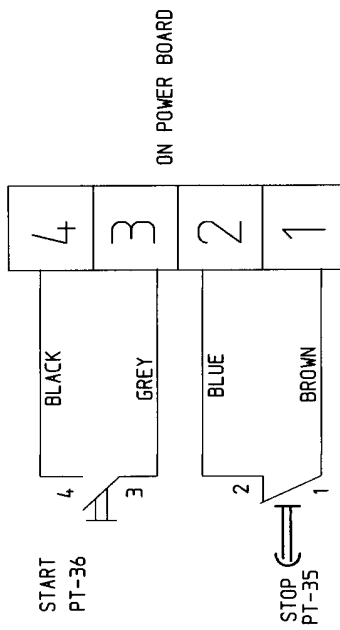

REV	SIG	DATE	REVISION	ECN NO.
<p>MONO EQUIPMENT QUEENSWAY SWANSEA WEST IND PARK SWANSEA, SA5 4EB. TEL: (01792) 561234 MONO SERVICE EQUIPMENT FAX: (01792) 561016 Email: engineering@monoequip.com</p>				
<p>MONO</p>				
<p>ELECTRICAL SPECIFICATIONS-</p>				
<p>TITLE: CONTROL CIRCUIT WIRING DIAGRAM SOFT START</p>				
<p>DRAWN: RAC SIB AT</p>				
<p>ELECTRICALLY APPROVED BY:-</p>				
<p>DATE: 10/12/06 29/5/06</p>				
<p>DRAWING NO. M073E25-08500</p>				
<p>REV: --</p>				

COPYRIGHT ©1998 - THIS DESIGN/DRAWING IS THE PROPERTY OF MONO EQUIPMENT LTD. AND MUST NOT BE REPRODUCED, COPIED, NOR ITS CONTENTS DIVULGED WITHOUT PRIOR WRITTEN PERMISSION.

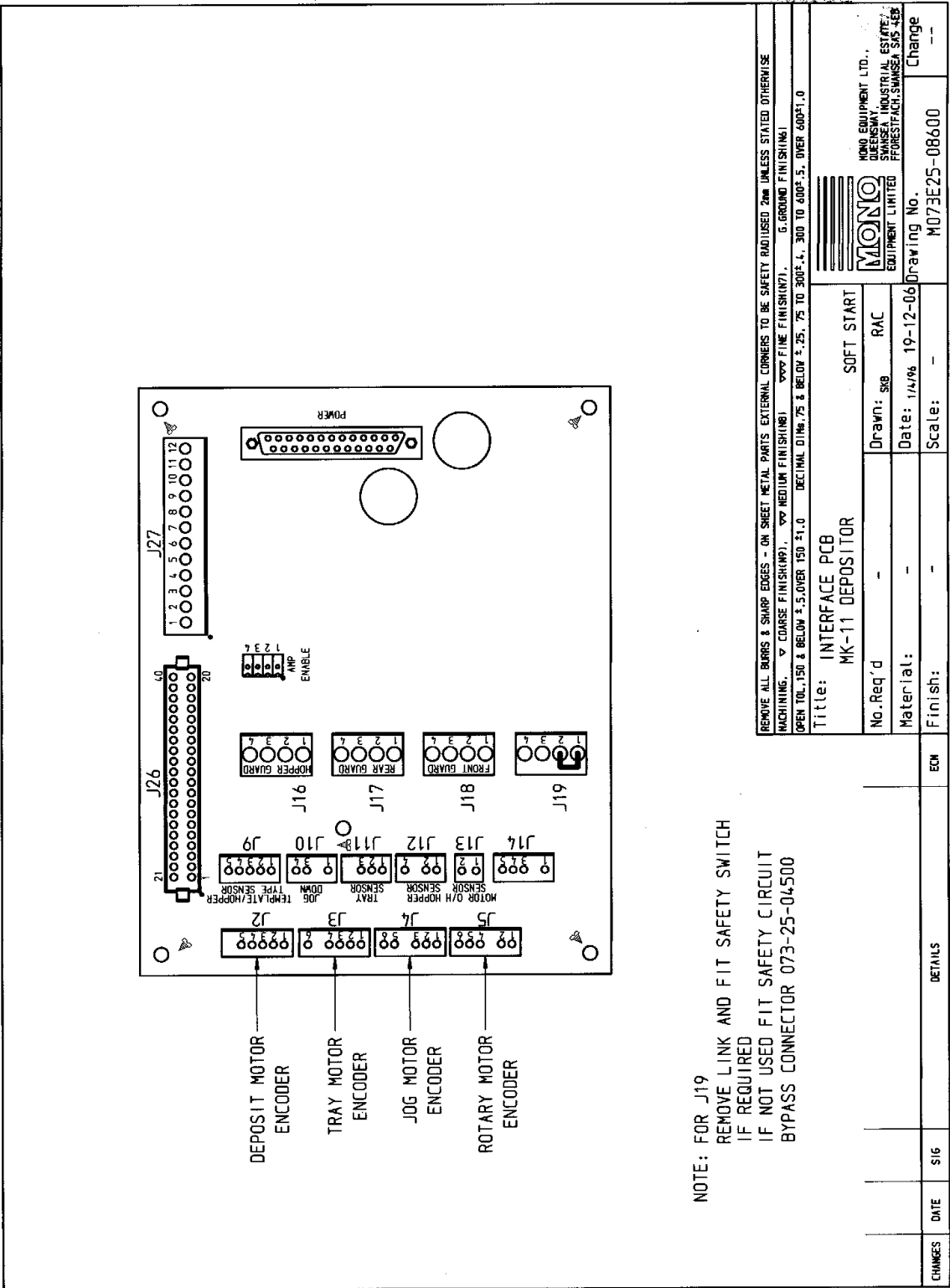

NOTE: FOR J19
 REMOVE LINK AND FIT SAFETY SWITCH
 IF REQUIRED
 IF NOT USED FIT SAFETY CIRCUIT
 BYPASS CONNECTOR 073-25-04500

REMOVE ALL BARRIS & SHARP EDGES - ON SHEET METAL PARTS EXTERNAL CORNERS TO BE SAFETY RADIUSED 2mm UNLESS STATED OTHERWISE
 MACHINING: ▽ COARSE FINISHING) ▽▽ MEDIUM FINISHING) ▽▽▽ FINE FINISHING) G. GROUND FINISHING)
 OPEN TOL. 150 & BELOW ±.5 OVER 150 ±1.0 DECIMAL DIM. 75 & BELOW ±.25 .75 TO 300 ±.4 .300 TO 400 ±.5 OVER 400 ±1.0

Title: INTERFACE PCB
 MK-11 DEPOSITOR
 SOFT START

No. Req'd	-	Drawn: SIG	RAC
Material:	-	Date: 1/11/06	19-12-06
Finish:	-	Scale:	Change ---

MONO EQUIPMENT LTD.,
 QUEENSWAY, INDUSTRIAL ESTATE,
 FORESTFACH, SWALES, S45 4EB

Drawing No. M073E25-08600

CHANGES	DATE	SIC	DETAILS	EOM

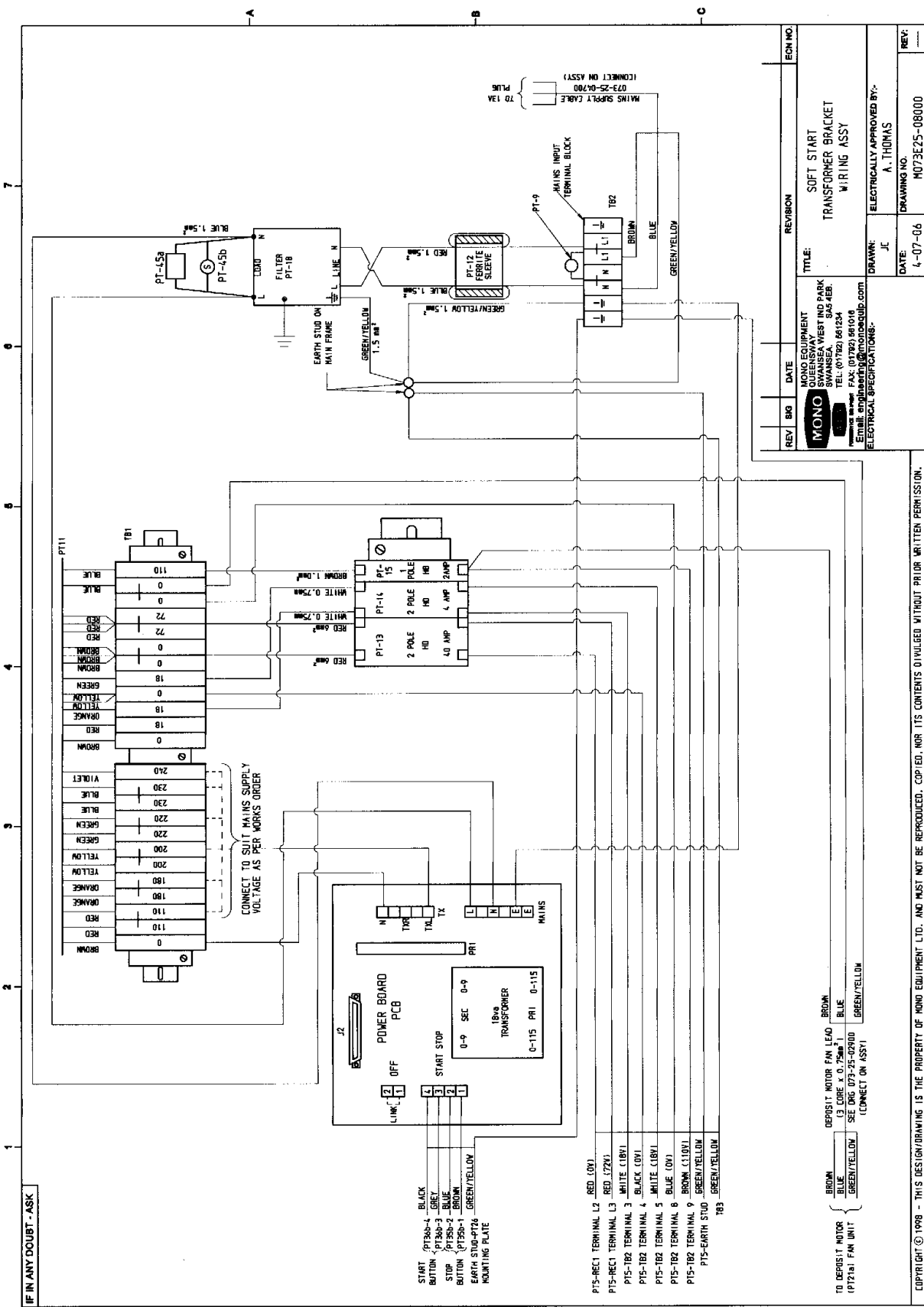

REV	SIG	DATE	REVISION	EDN NO.

TITLE: SUFT START TRANSFORMER BRACKET WIRING ASSY

MONO EQUIPMENT
 QUEENSWAY WEST END PARK SWANSEA
 TEL: (01782) 861234
 Email: engineering@monoequip.com

DRAWN: JC
DATE: 4-07-06
DRAWING NO.: M073E25-08000

ELECTRICALLY APPROVED BY: A. THOMAS

REV: _____

COPYRIGHT © 1998 - THIS DESIGN/DRAWING IS THE PROPERTY OF MONO EQUIPMENT LTD. AND MUST NOT BE REPRODUCED, COPIED, NOR ITS CONTENTS DILUTED WITHOUT PRIOR WRITTEN PERMISSION.

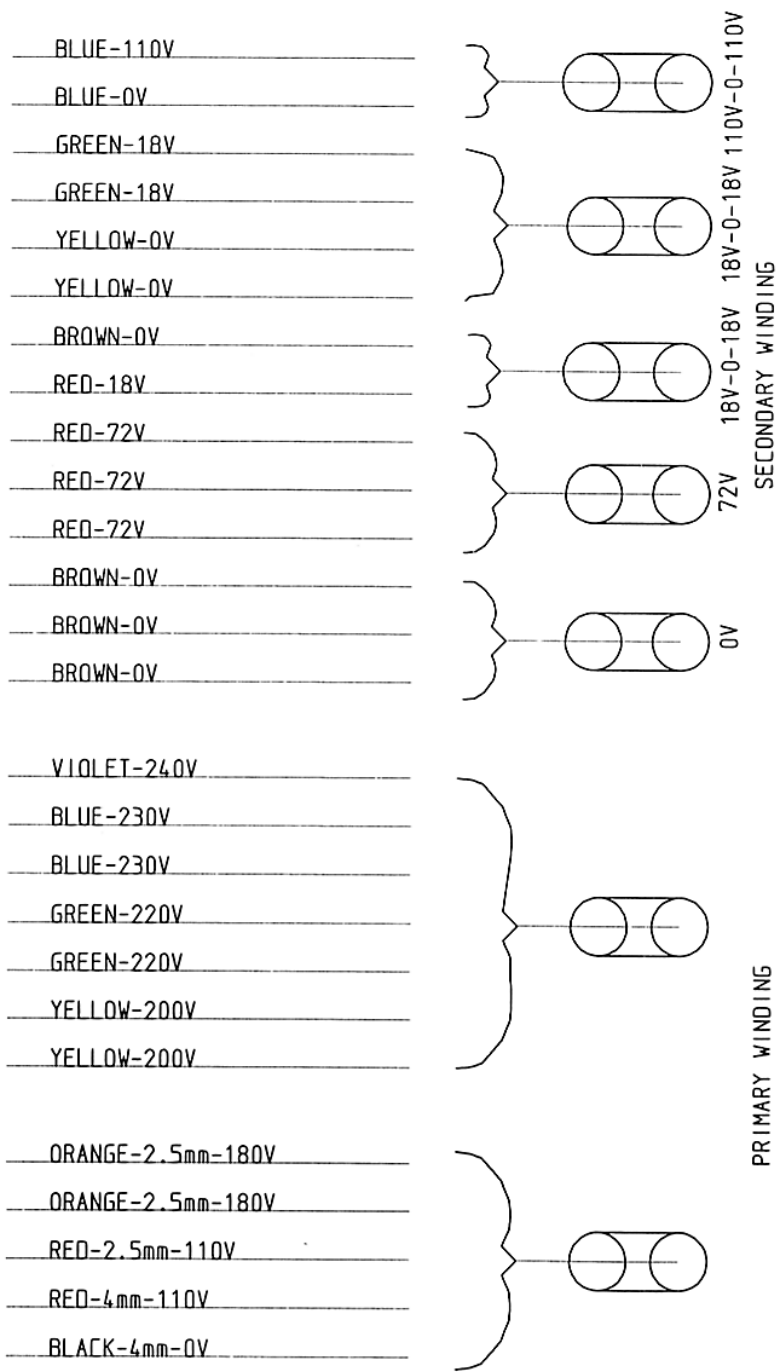

REMOVE ALL BURRS & SHARP EDGES - ON SHEET METAL PARTS. EXTERNAL CORNERS TO BE SAFETY RADIUSED 2mm UNLESS STATED OTHERWISE
MACHINING: ▽ COARSE FINISHING) ▽ MEDIUM FINISHING) ▽ FINE FINISHING) ▽ G. GROUND FINISHING) 6
(DPEN TOL.150 & BELOW ±.5.OVER 150 ±1.0 DECIMAL DIMS.75 & BELOW ±.25. 75 TO 300±.4. 300 TO 600±.5. OVER 600±1.0

Title: TRANSFORMER 26111 CONNECTIONS

No. Req'd	-	Drawn:	SKB
Material:	-	Date:	4/4/96
Finish:	-	Scale:	-

MONO
MOND EQUIPMENT LTD.,
RUE DE LA BRUNELLE INDUSTRIAL ESTATE
SWANSEA INDUSTRIAL ESTATE
FFRESTFACH, SWANSEA, SA5 4EB

Drawing No. M073-25-02400
Change -

IF IN ANY DOUBT - ASK

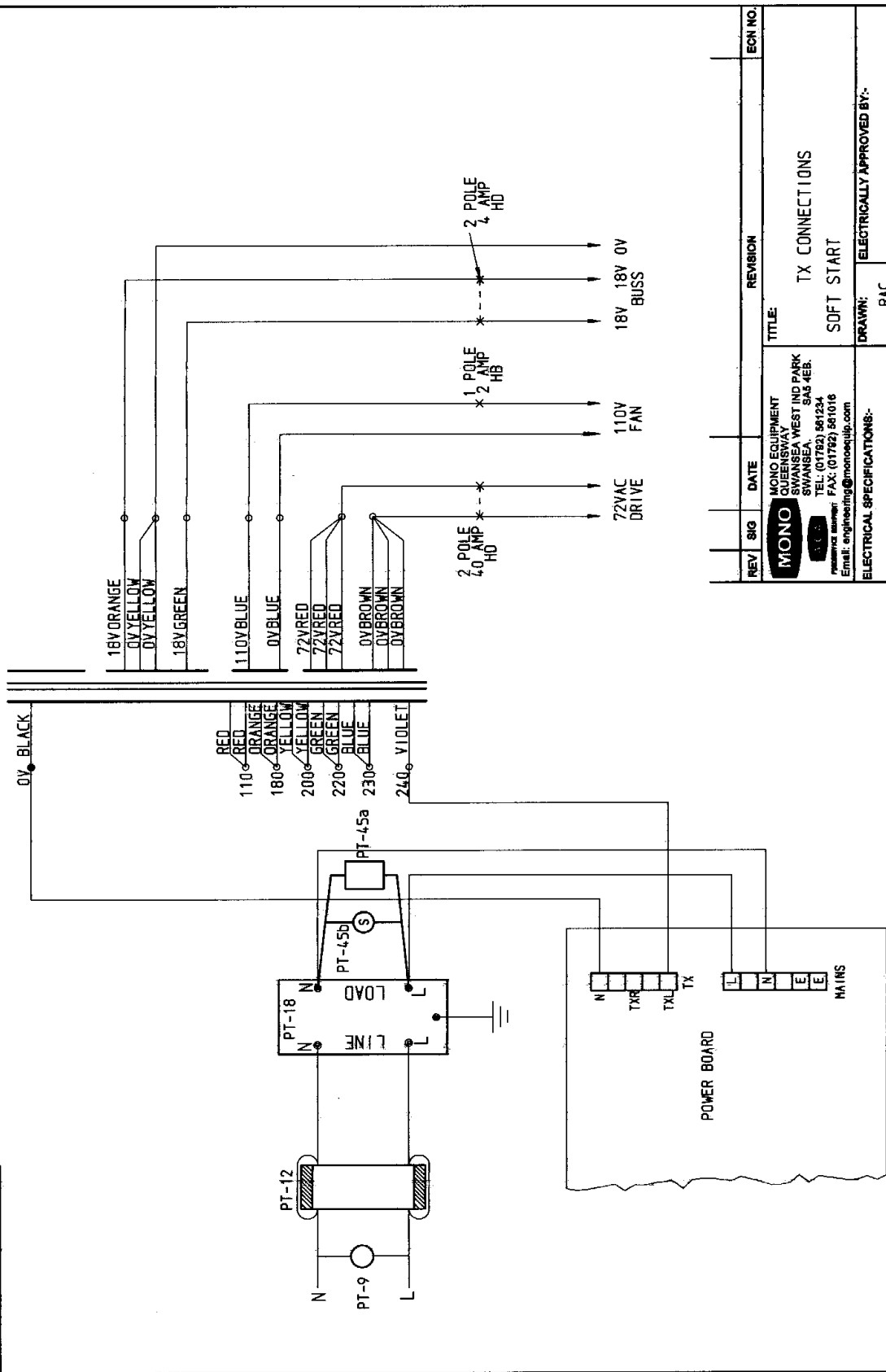

REV	SKG	DATE	REVISION	ECN NO.
MONO MONO EQUIPMENT CUBERSWAY WEST IND PARK SWANSEA SA5 4EB. TEL: (01792) 561234 FAX: (01792) 561016 Email: engineering@monoequip.com				
TITLE: TX CONNECTIONS SOFT START				
DRAWN: RAC SIB				
ELECTRICAL SPECIFICATIONS:-				
ELECTRICALLY APPROVED BY:-				
DATE: 19-12-06 29/5/96				
DRAWING NO: M073E25-08700				
REV: --				

COPYRIGHT © 1998 - THIS DESIGN/DRAWING IS THE PROPERTY OF MONO EQUIPMENT LTD. AND MUST NOT BE REPRODUCED, COPIED, NOR ITS CONTENTS DIVULGED WITHOUT PRIOR WRITTEN PERMISSION.

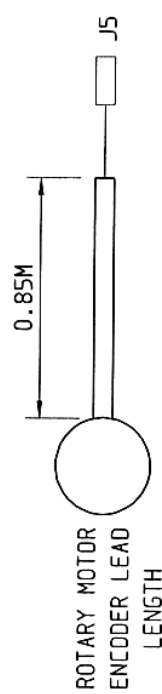
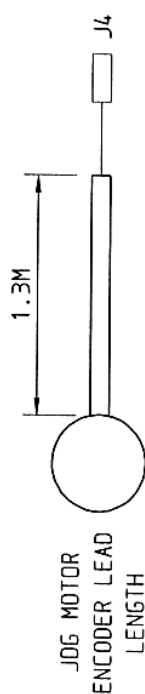
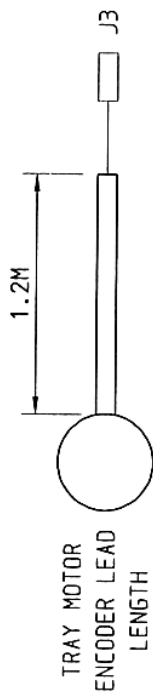
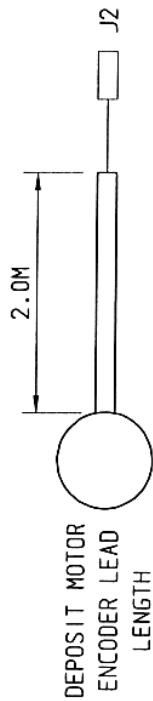

DEPOSIT ENCODER	TRAY ENCODER	JOG ENCODER	ROTARY ENCODER
RED = B	RED = B	RED = B	POLARIZING PIN
BLACK = -	BLACK = -	POLARIZING PIN	RED = B
SCREEN	POLARIZING PIN	BLACK = -	BLACK = -
POLARIZING PIN	SCREEN	SCREEN	SCREEN
2.0M	1.2M	1.3M	0.85M

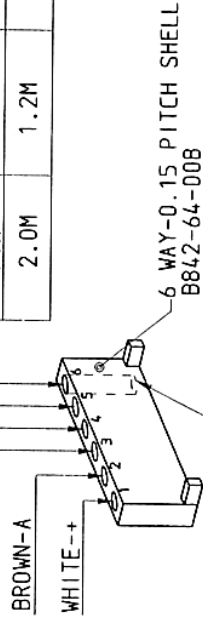

USE CRIMPER
MOLEX NO-69008-0956

REMOVE ALL BURRS & SHARP EDGES - DR SHEET METAL PARTS EXTERNAL CORNERS TO BE SAFETY RADIUSED 2mm UNLESS STATED OTHERWISE
 MACHINING: ▽ COARSE FINISHING, ▽▽ MEDIUM FINISHING, ▽▽▽ FINE FINISHING, ▽▽▽▽ GROUND FINISHING
 OPEN TOL.150 & BELOW ±.5, OVER 150 ±1.0 DECIMAL DIMS.75 & BELOW ±.25, .75 TO 300±.4, 300 TO 600±.5, OVER 600±1.0

Title: ENCODER TERMINAL BLOCK CONNECTIONS
MK11 DEPOSITOR

No. Req'd	-	Drawn:	SKB
Material:	-	Date:	19.8.96
Finish:	-	Scale:	-

MOMO EQUIPMENT LTD.,
QUEENSWAY,
SWANSEA INDUSTRIAL ESTATE,
FFORESTFACH, SWANSEA, SA5 4EB

Equipment Limited

Drawing No. M073-25-04600
Change -



MONO Equipment

Queensway, Swansea West Industrial Park, Swansea, SA5 4EB UK

Tel. 01792 561234

Fax. 01792 561016

Email:mono@monoequip.com

www.monoequip.com

As it is our policy to improve our machines continuously, we reserve the right to change specifications without prior notice.