



MonoEquip.com

Enter **Serial No's** here.

|         |
|---------|
| PROVER  |
| DIVIDER |
| MOULDER |



# Fusion Compact

BREAD PLANT

OPERATING AND MAINTENANCE MANUAL

# IMPORTANT NOTES

## SAFETY SYMBOLS

The following safety symbols are used throughout this product documentation and manual (available at [www.monoequip.com](http://www.monoequip.com)).

Before using your new equipment, read the instruction manual carefully and pay special attention to information marked with the following symbols.



### **WARNING**

Indicates a hazardous situation which, if not avoided, will result in death or serious injury.



### **WARNING**

Indicates a hazardous situation which, if not avoided, will result in electric shock.



### **CAUTION**

Indicates a hazardous situation which, if not avoided, will result in minor or moderate injury.



**DO NOT TRY TO DISABLE ANY SAFETY DEVICES,  
THEY ARE FITTED FOR YOUR SAFETY.**

## NOTE: DIVIDER OIL

**DO NOT USE ORDINARY VEGETABLE OIL FROM SHOP SHELVES, IN THE DIVIDER**  
*THIS WILL FORM A GUM-LIKE RESIDUE, CAUSING STICKING AND POSSIBLE DAMAGE TO THE MACHINE.*

MONO RECOMMENDS THE USE OF “**CRODA SUPER WUNDROL**”  
(AVAILABLE FROM MONO. **PART NUMBER “A900-25-272”**)

# **ELECTRICAL SAFETY AND ADVICE REGARDING SUPPLEMENTARY ELECTRICAL PROTECTION**

Commercial bakeries, kitchens and food service areas are environments where electrical appliances may be located close to liquids, or operate in and around damp conditions, or where restricted movement for installation and service is evident.

The installation and periodic inspection of the appliance should only be undertaken by a qualified, skilled and competent electrician, and connected to the correct supply suitable for the load as stipulated by the appliance data label.

The electrical installation and connections should meet the necessary requirements of the local electrical wiring regulations and any electrical safety guidelines.

## **We Recommend:**

- Supplementary electrical protection with the use of a residual current device (RCD)
- Fixed wiring appliances incorporate a locally situated switch disconnector to connect to, which is easily accessible for switching off and safe isolation purposes. The switch disconnector must meet the specification requirements of IEC 60947.

## **Your attention is drawn to:**

### **BS 7671:2018 – Guidance Note 8 – 8.13 : Other locations of increased risk**

It is recognised that there may be locations of increased risk of electrical shock other than those specifically addressed in Part 7 of BS 7671. Examples of such locations could include laundries where there are washing and drying machines in close proximity, and water is present, and commercial kitchens with stainless steel units, where once again, water is present. Where, because of the perception of additional risks being likely, the installation designer decides that an installation or location warrants further protective measures, the options available includes:

- Automatic Disconnection of Supply (ADS) by means of a residual current device having a residual operating current not exceeding 30 mA;
- Supplementary protective equipotential bonding; and
- Reduction of maximum fault clearance time.

The provision of RCDs and supplementary bonding must be specified by the host organisation's appointed installation designer or electrical contractor and installed by a suitably qualified and competent electrician so as to comply with Regulations 419.2 and 544.2.



The supply to this machine must be protected by a **30mA Type B RCD**

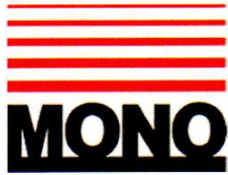

## DECLARATION OF CONFORMITY

We hereby declare that this machine complies with the essential health and safety requirements of :-

- The Machinery Directive 2006 / 42 / EC
- The Low voltage Directive 2014 / 35/ EC
- The requirements of the Electromagnetic Compatibility Directive 2004 / 108EC, 91 / 263 / EEC, 92 / 31 / EEC  
Incorporating standards  
EN55014-1:2006+A1:2009+A2:2011  
EN55014-2:1997+A1:2001+A2:2008
- The General Safety of Machinery and food processing Standards applicable
- Materials and Articles intended to come into contact with food  
Regulation (EC) No. 1935 / 2004

|  |   |
|--|---|
| <b>Signed</b>                          |  |
| <b>G.A. Williams – Quality Manager</b> |   |

|             |  |
|-------------|--|
| <b>Date</b> |  |
|-------------|--|

|                             |  |                               |  |
|-----------------------------|--|-------------------------------|--|
| <b>Machine<br/>FG Code.</b> |  | <b>Machine<br/>Serial No.</b> |  |
|-----------------------------|--|-------------------------------|--|

A technical construction file for this machine is retained at the following address:

**MONO EQUIPMENT**  
Queensway,  
Swansea West Industrial Park,  
Swansea  
SA5 4EB  
UK

**MONO EQUIPMENT** is a business name of **AFE GROUP Ltd**  
Registered in England No.3872673 VAT registration No.923428136

Registered office: Unit 9, Bryggen Road,  
North Lynn Industrial Estate,  
Kings Lynn,  
Norfolk,  
PE30 2HZ



**SECTION 1 - BREAD PLANT ASSEMBLED**

**INSTALLATION (Prover – Divider – Moulder), CLEANING,  
MAIN CONTROLS, AND BREAD PLANT OPERATION**

**SECTION 2 - DOUGH DIVIDER**

**DETAILED MAIN INSTRUCTIONS**

**SECTION 3 - MOULDER**

**MAIN INSTRUCTIONS**

# CONTENTS

---

## **SECTION 1 – BREAD PLANT ASSEMBLED**

|            |  |   |           |
|------------|--|---|-----------|
| <b>1.0</b> | <b>INTRODUCTION</b> .....                    | <i>Description of plant</i> .....                                   | <b>10</b> |
| <b>2.0</b> | <b>GENERAL DIMENSIONS</b> .....              | <i>Prover, Divider, and Moulder.</i> .....                          | <b>11</b> |
|            | 2a. Overall dimensions .....                 | <i>Bread plant assembled</i> .....                                  | 12        |
| <b>3.0</b> | <b>SPECIFICATIONS</b> .....                  | <i>Power, weight, and noise level.</i> .....                        | <b>13</b> |
| <b>4.0</b> | <b>SAFETY</b> .....                          | <i>Precautions when using the equipment</i> .....                   | <b>14</b> |
| <b>5.0</b> | <b>INSTALLATION</b> .....                    | <i>General, Divider, Rounder, and Moulder.</i> .....                | <b>15</b> |
| <b>6.0</b> | <b>ISOLATION</b> .....                       | <i>Emergency stop; turning off for cleaning and servicing</i> ..... | <b>20</b> |
| <b>7.0</b> | <b>CLEANING</b> .....                        |   | <b>21</b> |
|            | ▪ <b>Prover</b>                              |   |           |
|            | Daily cleaning .....                         |   | 22        |
|            | Weekly cleaning .....                        |   | 23        |
|            | Carrier pocket removal .....                 |   | 23        |
|            | ▪ <b>Divider</b>                             |   |           |
|            | Daily cleaning .....                         |   | 24        |
|            | Weekly cleaning .....                        |   | 27        |
|            | ▪ <b>Moulder</b>                             |   |           |
|            | Daily cleaning .....                         |   | 28        |
|            | Weekly cleaning .....                        |   | 30        |
| <b>8.0</b> | <b>OPERATING INSTRUCTIONS</b> .....          |   | <b>31</b> |
|            | a. Operation of the Prover .....             |   | 31        |
|            | b. How to operate the Mono bread plant ..... |   | 32        |
| <b>9.0</b> | <b>MAINTENANCE</b> .....                     |   | <b>34</b> |

---

**PLEASE READ THESE MORE DETAILED SECTIONS BEFORE USING THIS PLANT**

**SECTION 2 - Dough divider**

**SECTION 3 - Moulder**

---

**SECTION 2 - DOUGH DIVIDER**

1.0 INTRODUCTION ..... 38

2.0 GENERAL DIMENSIONS ..... 39

3.0 SPECIFICATIONS ..... 39

4.0 SAFETY ..... 40

5.0 INSTALLATION ..... 41

6.0 ISOLATION ..... 44

7.0 CLEANING ..... 44

- Daily ..... 44
- Weekly ..... 48

8.0 OPERATING ..... 49

9.0 MAINTENANCE ..... 52

10.0 TROUBLESHOOTING ..... 54

11.0 SPARES AND SERVICE ..... 61

---

**FOR SERVICE AND SPARES RING: 01792 564044**

---

12.0 ELECTRICAL INFORMATION ..... 62

**SECTION 3 – MOULDER**

1.0 INTRODUCTION ..... 69

2.0 OVERALL DIMENSIONS ..... 69

3.0 SPECIFICATIONS ..... 70

4.0 SAFETY ..... 71

5.0 INSTALLATION ..... 72

6.0 ISOLATION ..... 73

7.0 CLEANING ..... 74

- Daily ..... 74
- Weekly ..... 76

8.0 OPERATING INSTRUCTIONS ..... 77

9.0 TROUBLESHOOTING ..... 81

10.0 SPARES AND SERVICE ..... 82

---

**FOR SERVICE AND SPARES RING: 01792 564044**

---

11.0 ELECTRICAL INFORMATION ..... 84

12.0 MAINTENANCE ..... 87



# SECTION 1



BREADPLANT ASSEMBLED

# 1.0 INTRODUCTION

---

The **Mono FUSION COMPACT** bread plant is a fully integrated unit enabling rapid change of product lines without moving any items of equipment.

It consists of three machines: The “**DIVIDER**”, the “**PROVER**” and the “**MOULDER**”.



## 2.0 GENERAL DIMENSIONS

---

### PROVER

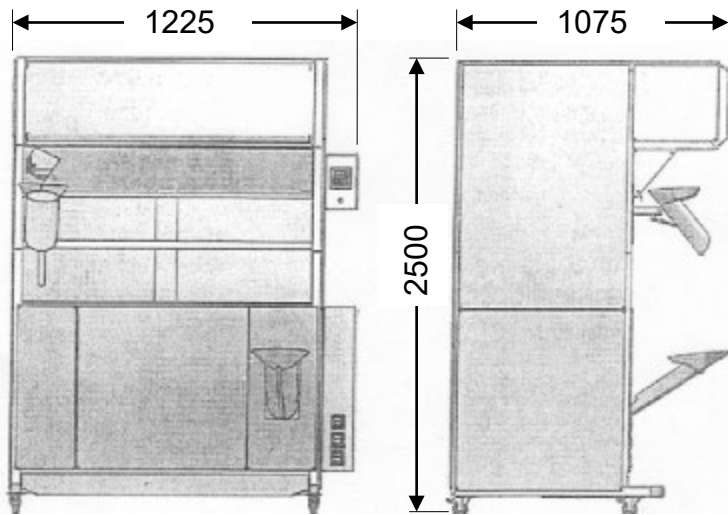

**Height:**  
2500mm.  
**Depth:**  
1075mm.  
**Width:**  
1225mm.

### MOULDER

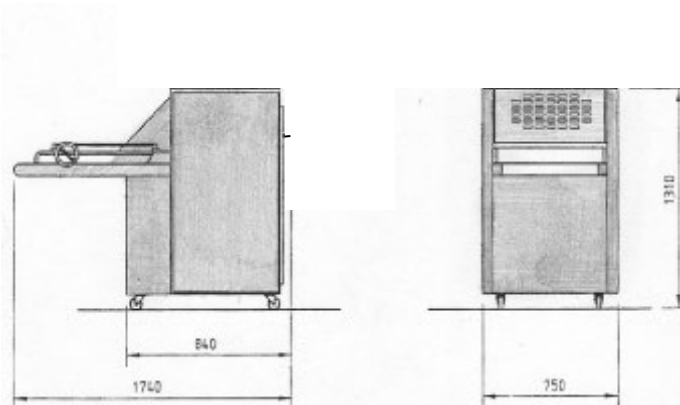

**Height:**  
1310mm.  
**Depth:**  
1740mm.  
**Width:**  
750mm.

### DIVIDER

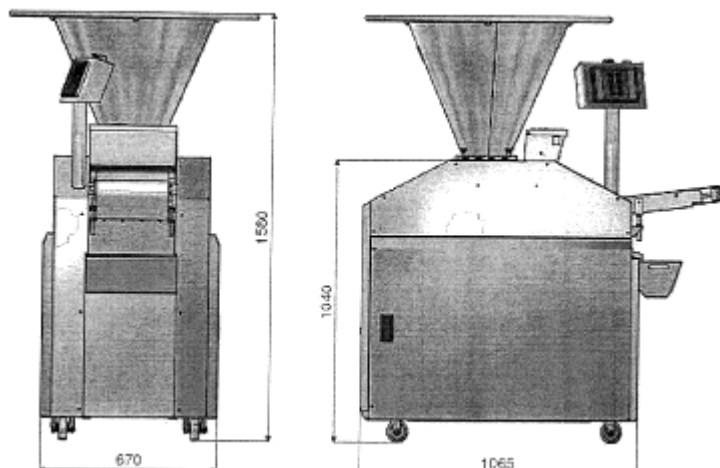

**Height:**  
1580mm  
**Depth:**  
1065mm.  
(inc. conveyor 1400mm)  
**Width:**  
670mm

# 2a OVERALL DIMENSIONS

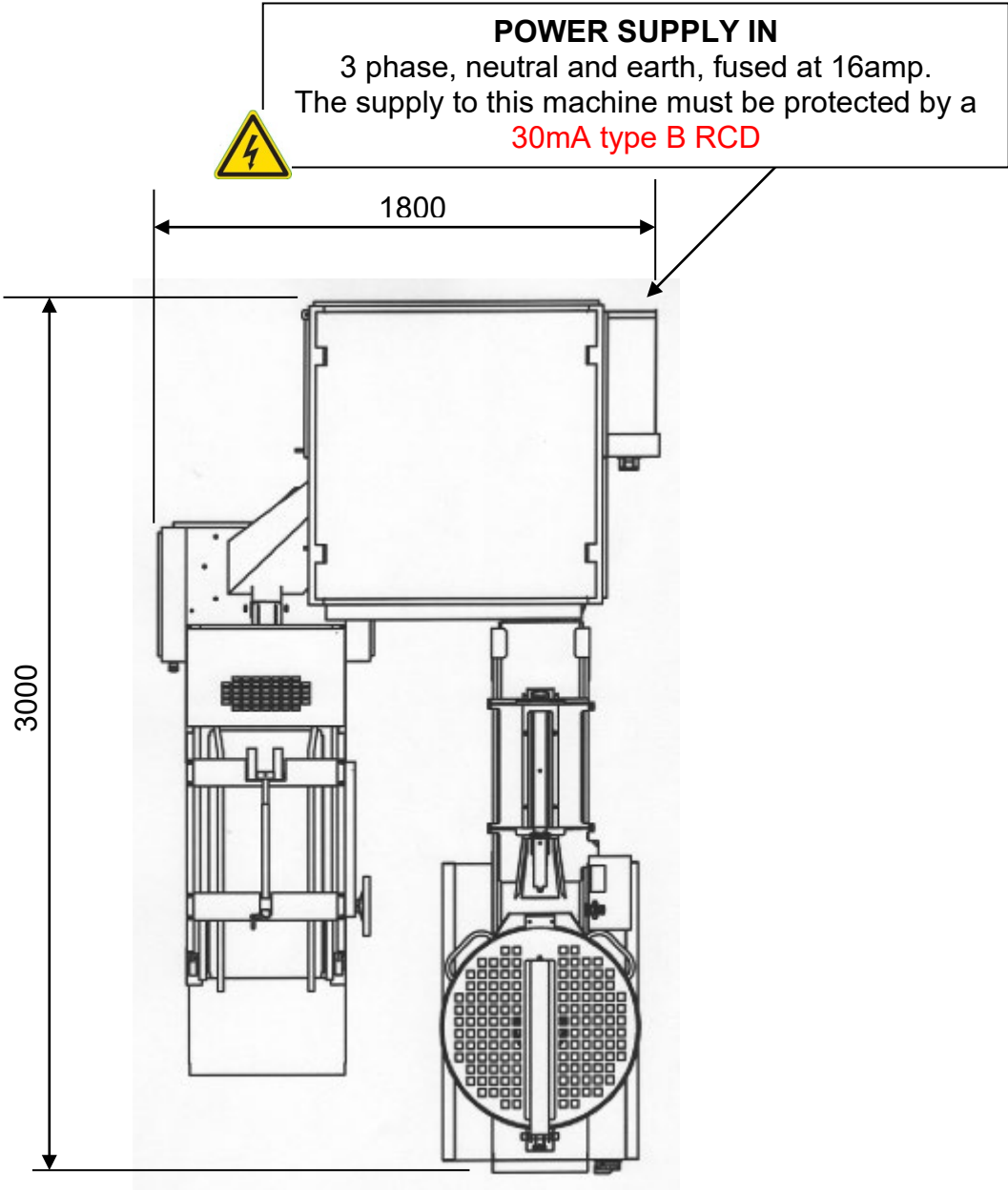

**PLAN VIEW**

TOTAL AREA REQUIRED = 1800 X 3000  
HEIGHT (PROVER) = 2500

DIMENSIONS IN MILLIMETRES

# 3.0 SPECIFICATIONS

---

**TOTAL PLANT**            415v. 3 phase, neutral and earth, fused at 16amp  
(ALL MACHINES CONNECTED TOGETHER)

**POWER:    4.4kW**



The supply to this machine must be protected by a **30mA type B RCD**

**PROVER**

POWER:                    **0.37kW**

WEIGHT:                 **400kg**

NOISE LEVEL:           **Less than 85dB**

---

**MOULDER**

POWER:                    **0.75kW**

WEIGHT:                 **230kg**

NOISE LEVEL:           **Less than 85dB**

---

**DIVIDER**

POWER:                    **3.2kW**

WEIGHT:                 **500kg**

NOISE LEVEL:           **Less than 85dB**

## 4.0 SAFETY



IF YOU ENCOUNTER ANY ISSUE WITH THIS EQUIPMENT THAT YOU HAVE NOT BEEN TRAINED FOR, YOU MUST CONTACT YOUR INSTORE TECHNICIAN.



- 1 **Never use a machine in a faulty condition** and always report any damage.
- 2 **Only trained engineers may remove any part** that requires a tool to do so.
- 3 **People undergoing training on this machine must be under direct supervision** of a fully trained person.



- 4 **Use of this machine can prove dangerous if:**
  - the machine is operated by untrained or unskilled staff
  - the machine is not used for its intended purpose
  - the machine is not operated correctly



- 5 **Always ensure hands are dry before touching any electrical appliance** (including cable, switches and plugs).

- 6 **Do not operate the machine with any panels or guards removed.**

- *All safety devices applied to the machine during manufacture and the operating instructions in this manual are required to operate this machine safely. The owner and the operator are responsible for operating this machine safely.*



- ***DO NOT TRY TO DISABLE ANY SAFETY DEVICES, THEY ARE FITTED FOR YOUR SAFETY.***

- 7 **NEVER move machinery by pulling on the power cords or cables.**

- 8 **No loose clothing or jewellery** should be worn while operating this machine

- 9 **The bakery manager or the bakery supervisor must carry out daily safety checks** on this machine.

- 10 **No one under the age of 16 may operate** this machine.

- 11 **No one under the age of 18 may clean** this machine under any circumstances.



- 12 **DO NOT STAND ON ANYTHING TO LOAD THE DIVIDER HOPPER.**



- 13 **DO NOT STAND ON OR STORE ITEMS ON THE PROVER ROOF.**



**ALL CLEANING AND MAINTENANCE OPERATIONS MUST BE MADE WITH MACHINE DISCONNECTED FROM THE POWER SUPPLY.**

## 5.0 GENERAL INSTALLATION

The supply to this machine must be protected by a **30mA type B RCD**

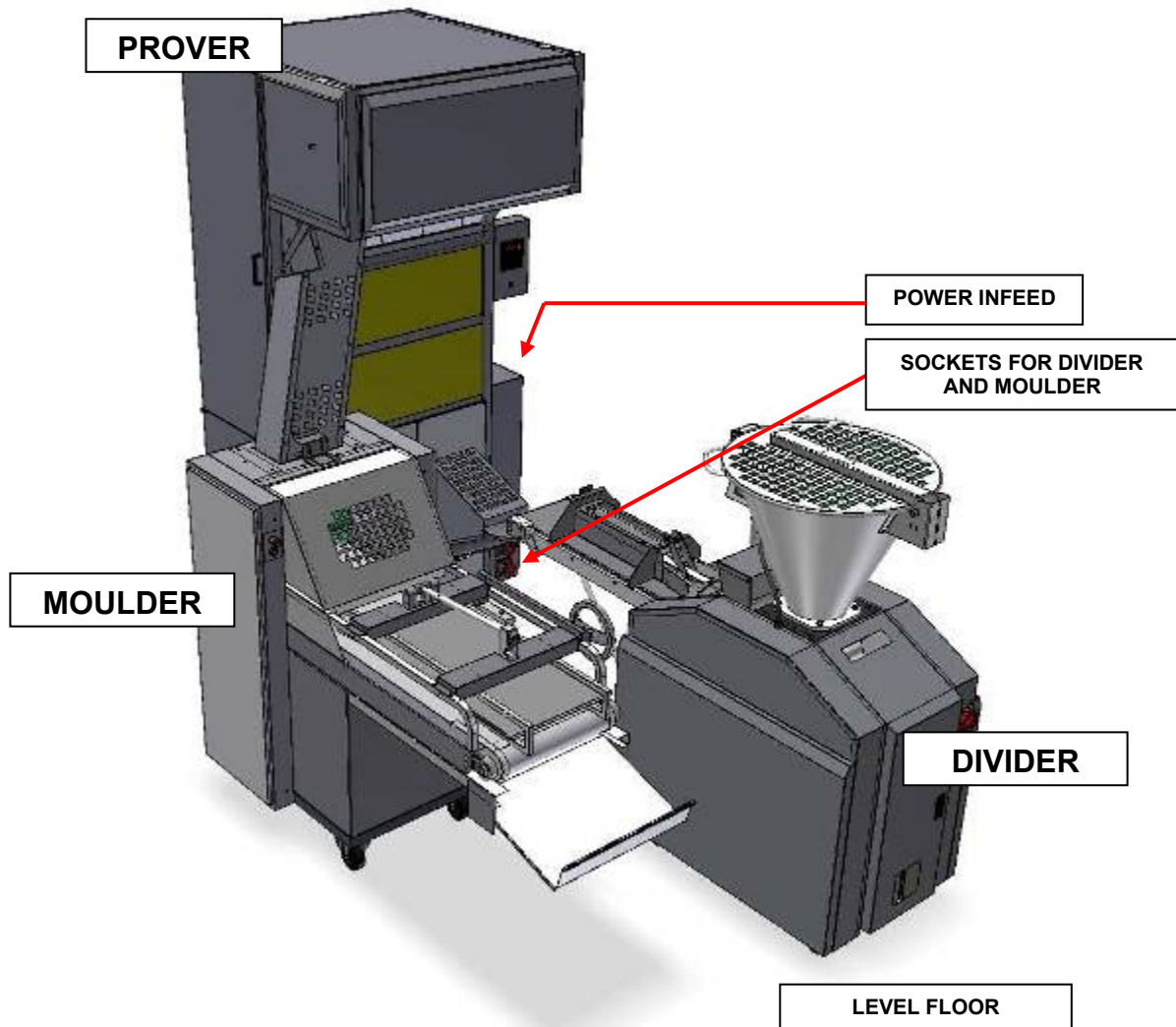

1. The plant should be positioned on a solid level floor.
2. The plant should be connected to a mains wall isolator.  
(Mains infeed from rear of prover electrical box)
3. Insert divider plug into the correct socket on the front of the prover electrical box.
4. Insert moulder plug into the correct socket on the front of the prover electrical box.



## **DO NOT ATTEMPT TO LIFT THE DIVIDER BY HUMAN FORCE (LIFTING)**

- Use of a **forklift or crane** is recommended for lifting or the machine can be pushed on the castors provided.
- **To lift with a forklift** - the machine must be secured to a pallet.
- **To lift with a crane** - lifting eyes are provided.



LIFTING EYES

Check that the power rating on the serial number plate matches the supply that the machine is to be connected to.

- The Dough Divider should be connected to a power socket on the prover.



POWER SOCKETS



## DIVIDER INSTALLATION

- Check the machine after installation to ensure the belt moves in the correct direction indicated (see arrow in photo below).

*(If wrong - swap positions of any two of the three phase carrying wires in the plug.  
This should be factory set and not need to be done)*

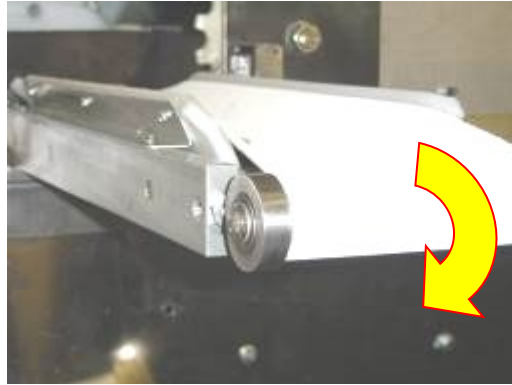

- Fill oil tank to 2/3 level, with your company recommended food safe oil.

### WARNING!

**DO NOT USE ORDINARY VEGETABLE OIL FROM SHOP SHELVES, IN THE DIVIDER THIS WILL FORM A GUM-LIKE RESIDUE, CAUSING STICKING AND POSSIBLE DAMAGE TO THE MACHINE.**

MONO RECOMMENDS THE USE OF “CRODA SUPER WUNDROL” (AVAILABLE FROM MONO. PART NUMBER “A900-25-272”)

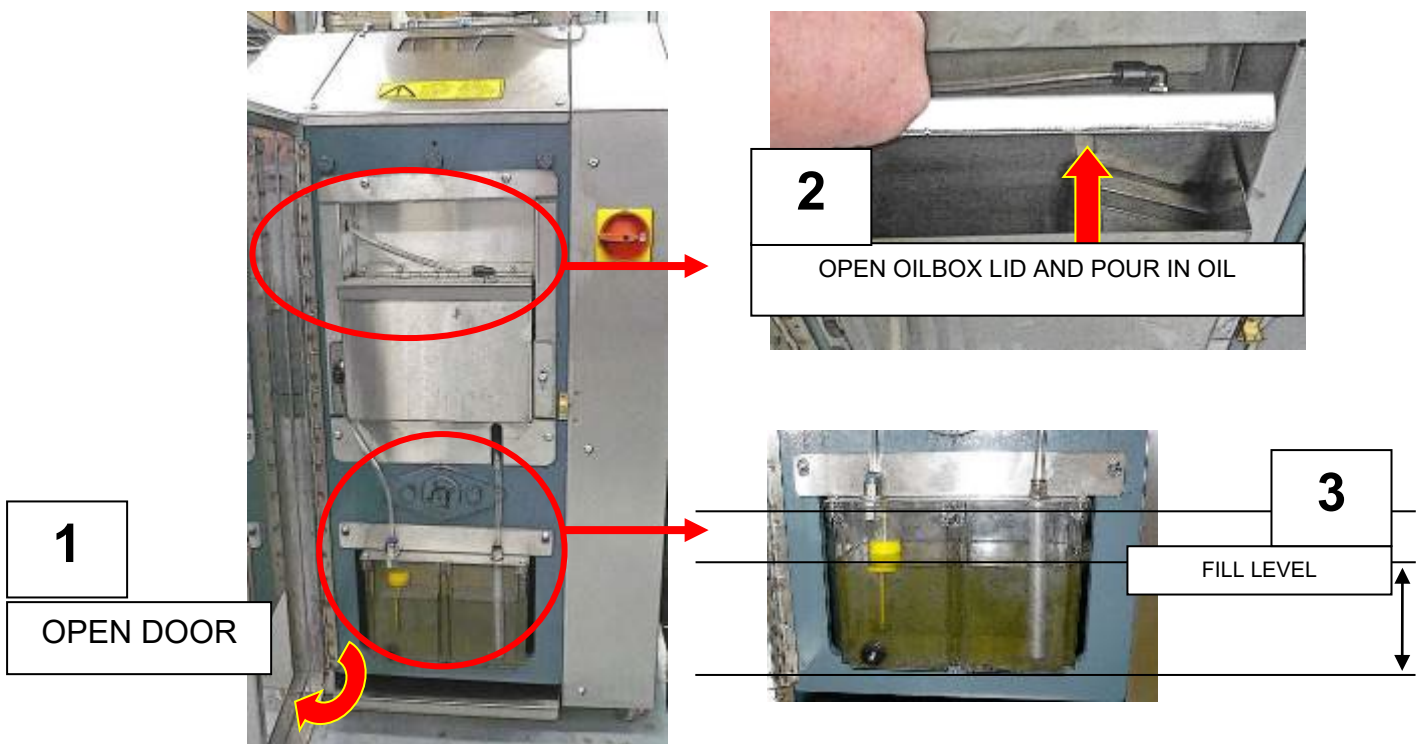

## Positioning Divider.

- 1 Ensure the divider is standing on a solid level floor.
- 2 Correctly position the divider so that dough will leave the divider and roll down the infeed chute of the prover.  
(or use the locator mechanism if included)



- 3 After the connection is made, lock the two front castors into place.

## Positioning Moulder.

- 1 Ensure the moulder is standing on a solid level floor.
- 2 Correctly position the moulder under the chute so that the red magnet and switch are inline.(or use the locator if included)



- 3 When the position is correct, lock the two locking castors into place.

# 6.0 ISOLATION



## EMERGENCY STOP BUTTONS

### TO STOP THE BREAD PLANT IN AN EMERGENCY

Switch off at the main isolator,  
or use the **emergency stop button** on the control panel

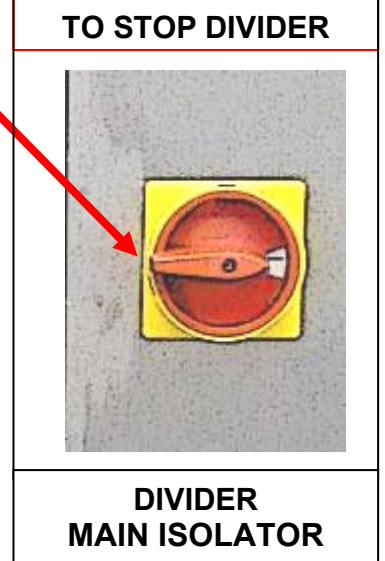
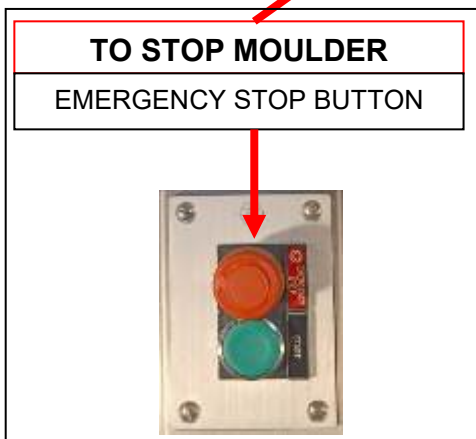
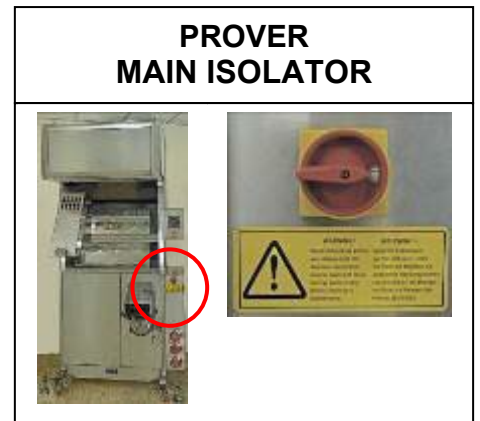
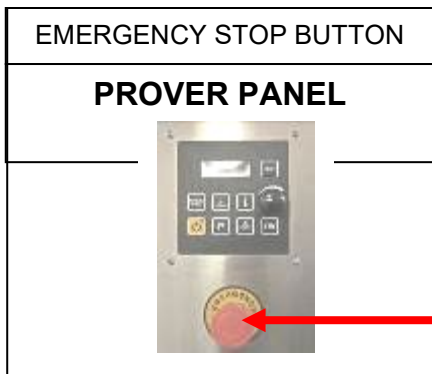

**WARNING**  
Except in an emergency, do not halt the prover with dough in the carriers and leave it. Dough will adhere to the pockets and may cause the prover to malfunction.

## 7.0 CLEANING

PROVER  
DIVIDER  
MOULDER



**SWITCH OFF AND ISOLATE THE MACHINES FROM MAINS SUPPLY BEFORE COMMENCING CLEANING**

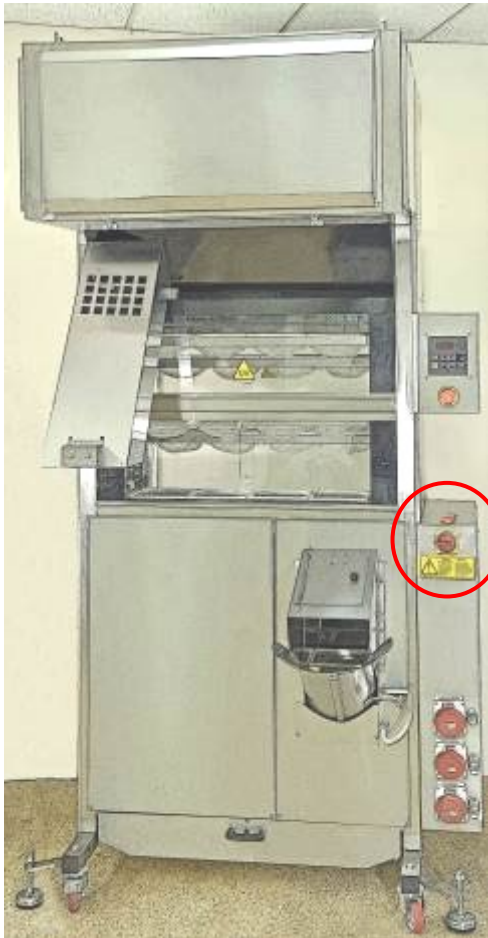

MAINS SUPPLY ISOLATOR

### NOTES

1. **Except in an emergency**, do not halt the prover with dough in the carriers and leave it. Dough will adhere to the pockets and may cause the machine to malfunction.
2. ALWAYS CHECK THE POCKETS FOR ADHERING DOUGH AND REMOVE AS SOON AS POSSIBLE. DO NOT WAIT FOR DAILY CLEANING IF IN DOUBT.
3. NEVER LEAVE THE DIVIDER WITH DOUGH IN THE DOUGH CHAMBER **AS PRESSURES CAN BUILD UP AS THE DOUGH PROVES.**



# PROVER CLEANING INSTRUCTIONS

## DAILY CLEANING

1. Brush the infeed chute (1) ensuring the dough sensor is clean.
2. Remove the drawer (2) and wash thoroughly, dry and replace.
3. Wipe the clear window (3) .
4. Open the main overhang door (4) and check for fallen pieces of dough inside. Brush rear of door and close.
5. Brush out the hopper (5) and wipe clean the metalwork, paying attention to the inner sides where dough can collect.
6. Wipe over the control box (6) with a damp cloth (do not allow moisture to enter the panel).
7. Brush down the outer sheeting of the machine.

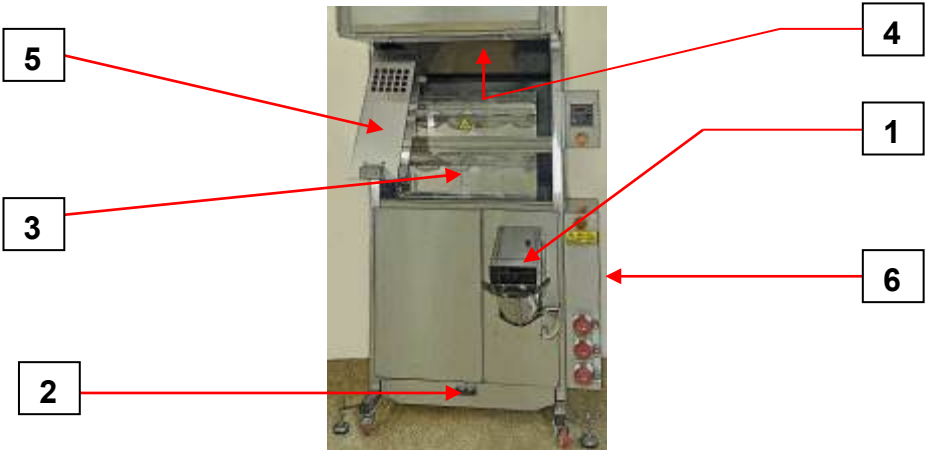

**KEEP WATER AWAY FROM THE MAIN CONTROL PANEL AND ELECTRICAL CONNECTION SOCKETS.**

RIGHT HAND VERSION SHOWN

## CAUTION



ISOLATE THE PROVER FROM THE POWER SUPPLY BEFORE CLEANING.

As daily cleaning and also: -

1. Wipe over all outer sheeting and doors with sanitising solution.

**KEEP WATER AWAY FROM THE MAIN CONTROL PANEL  
AND ELECTRICAL CONNECTION SOCKETS.**

2. Ensure the roof sheeting is clear and brush clean as required.



**Do not stand on or store items on the roof**

3. Remove the drawer (2) and inspect the floor area. Clean as required.

## CARRIER POCKET REMOVAL (as required)

1. Open the front windows to access carriers.
2. Hold the carrier body and pull the carrier pocket gently upwards to unclip. *(Note that there are 4 pockets to a carrier and each one can be replaced individually).*  
Wash, dry and replace.

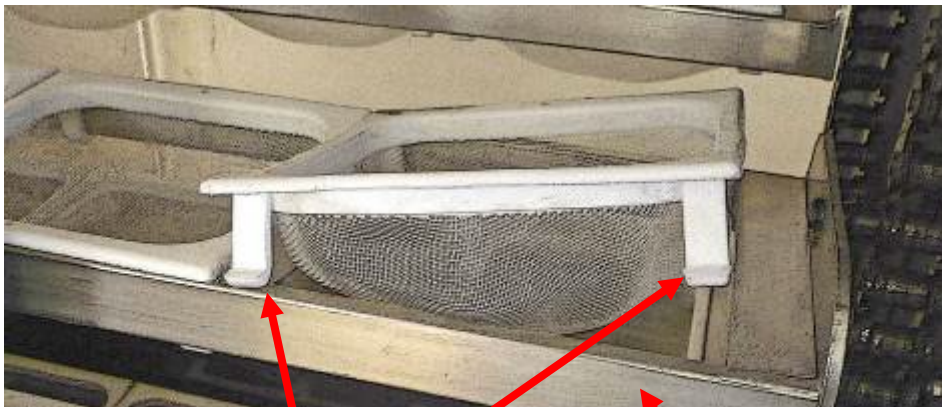

**MOULDED CLIPS**

**CARRIER**

### **Warning**

Avoid stopping machine with dough left in the pockets, as after a time it will adhere to the pockets and cause the machine to malfunction.  
ALWAYS CHECK THE POCKETS FOR ADHERING DOUGH AND REMOVE AS SOON AS POSSIBLE. DO NOT WAIT FOR DAILY CLEANING IF IN DOUBT.

# DIVIDER CLEANING INSTRUCTIONS

## DAILY



**NOTE:**

**ISOLATE THE DIVIDER FROM THE MAINS SUPPLY BEFORE CLEANING.**

- CLEANING SHOULD ONLY BE CARRIED OUT BY FULLY TRAINED PERSONNEL
- DO NOT USE A HIGH PRESSURE WASHER
- DO NOT USE SOLVENTS OF ANY KIND
- KEEP CLEANING FLUIDS AWAY FROM ELECTRICAL SWITCHES

- 1 Remove any dough residue from the interior of the hopper.  
(Only use a **plastic scraper**)
- 2 Smear the interior of the hopper with divider oil.
- 3 Check the oil level is correct (refill if required).  
Then run the divider for a minute, using on/off buttons on the control console.  
(This will stop the machine from seizing up by coating the drum with oil)

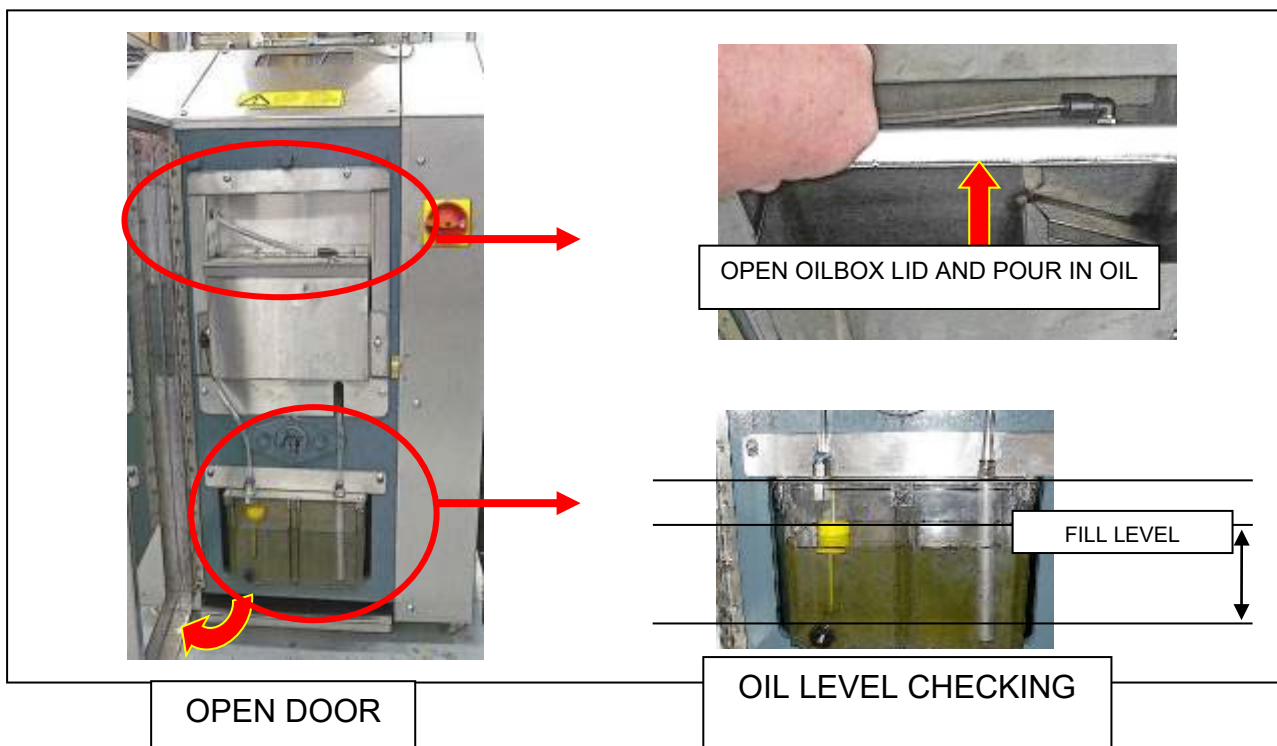

**NOTE:**

**THE ABOVE STEPS MUST BE FOLLOWED DAILY, OTHERWISE IT WILL LEAD TO THE BUILD UP OF STARCH AND SEIZURE OF THE MACHINE.**



**OFF TAKE CLEANING**

REMOVE SCALES IF FITTED.  
Unplug and lift off.

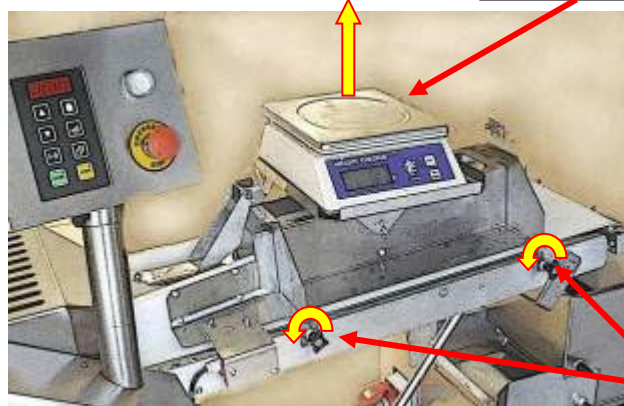

LOOSEN KNOBS | 1

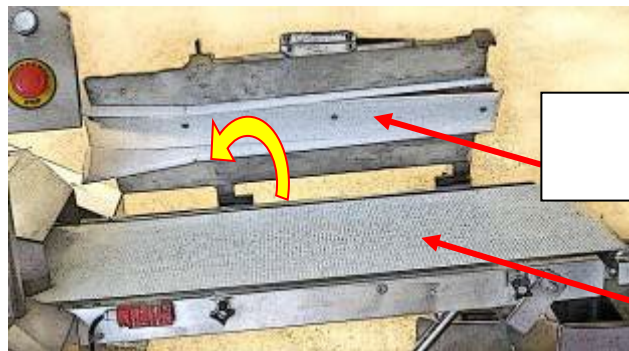

PIVOT  
PRESSURE BOARD | 2

BELT

- 1 Unplug and remove the scales.
- 2 Loosen the two black knobs on the side of the pressure board.
- 3 Pivot the pressure board away from you.  
Help may be required to hold the pressure board while cleaning takes place.
- 4 Remove any dough residue and brush exposed parts.
- 5 Scrape and wipe down the belt. (Only use a **plastic scraper**).
- 6 Remove any dough residue from the conveyor metal work and belt surface.
- 7 Lower the pressure board and tighten the two black knobs on the side.
- 8 Replace and plug in the scales.



**EXTERNAL CLEANING**

- 1 Brush off any flour residue and scrape as necessary. (Only use **plastic scraper**)
- 2 Brush off loosened dough.
- 3 Make up sterilising solution and hot water.
- 4 Clean the exterior of the divider as necessary working from top to bottom.
- 5 Swab dry with disposable tissue.

**UNDER CONVEYOR COLLECTION BOX**

- 1 Brush the chute debris into the collection box.

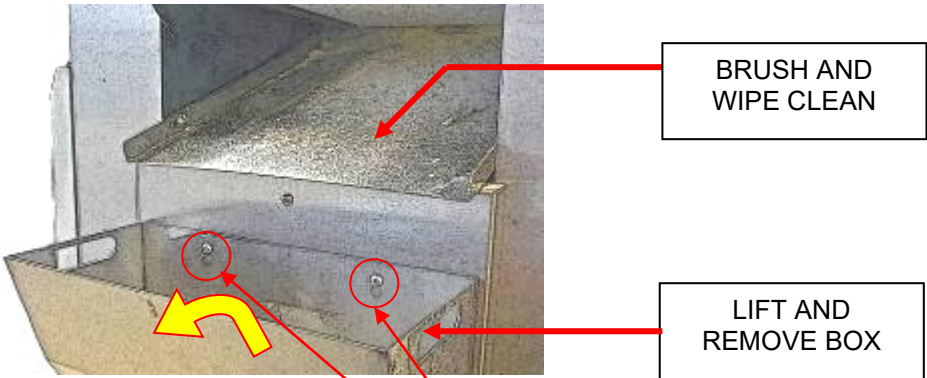

- 2 Lift and remove the collection box and clean.
- 3 Replace the collection box, making sure it is pushed right down on locating screws.



## **WEEKLY**



**NOTE:**

CLEANING SHOULD ONLY BE CARRIED OUT BY FULLY TRAINED PERSONNEL



**WARNING: ISOLATE DIVIDER FROM MAINS SUPPLY**

1. Scrub wheels with a small nylon cleaning brush or scouring pad and hot water sterilising solution.
2. Clean entire exterior surfaces of the divider, working from top to bottom.

# MOULDER CLEANING INSTRUCTIONS



**NOTE:- SWITCH OFF AND ISOLATE FROM THE MAINS SUPPLY BEFORE COMMENCING ANY CLEANING.**

## DAILY CLEANING (DO NOT USE A PRESSURE WASHER)

1. Pull machine away from the prover.
2. Scrape off any dough residue.



5. Raise front-hinged cover (2).
6. Lift out curling chain (3) and shake off any dough residue, then brush with a stiff nylon brush. **\*\*\*DO NOT WASH\*\*\***
7. Replace chain.
8. Unclip and wipe clean the scrapers (see photo above). **\*\*\*DO NOT WASH\*\*\***  
Smear edges with vegetable oil.
9. Scrape rollers with a **plastic** scraper and remove any debris from the roller edges.
10. Replace scrapers and close front cover.

11. Unclip and lower the rear window (5)



12. Unclip and wipe the rear scrapers  
**\*\*\*DO NOT WASH\*\*\***  
 Smear edges with vegetable oil.
13. Scrape rollers with a **plastic** scraper and remove any debris from the roller edges.
14. Replace scrapers. Raise rear window. Wipe over Perspex window, with soft cloth dampened in a sterilising solution and hot water.
15. Open dough guides to maximum width by turning wheel (6).  
 Push pressure board (7) towards the main body, and then withdraw.

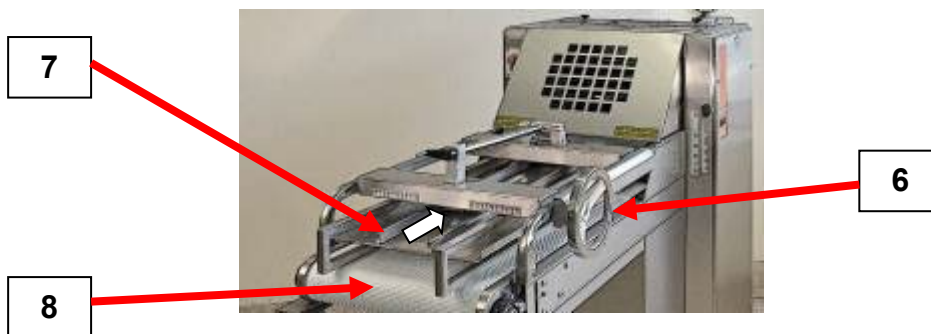

16. Wash board in sterilising solution and hot water, then dry well and replace.
17. Scrape dough belt (8) with a **plastic scraper**.

**DO NOT USE A METAL SCRAPER OR ATTEMPT TO CLEAN WITH WATER. BELT WILL NEED TO BE INCHED FORWARD TO GAIN ACCESS TO ALL PARTS OF THE SURFACE. SEE SAFETY INSTRUCTIONS.**

18. Brush down external surface of machine to loosen any dough remaining.

19. Spot clean with cloth and sterilising solution and hot water paying particular attention to handles, levers and controls.

## **WEEKLY CLEANING**

### **MOULDER CLEANING**



**NOTE:**  
**SWITCH OFF AND ISOLATE FROM THE MAINS SUPPLY BEFORE COMMENCING ANY CLEANING.**

1. Follow the daily cleaning instructions 1 - 14 in previous section.
2. Remove side and back panels placing screws in a safe place.
3. Brush down framework where accessible to remove excess flour and dough.
4. Wipe down with a damp cloth and sterilising fluid and hot water.
5. Replace panels ensuring all screws are accounted for.
6. Follow the daily cleaning instructions 15 - 19 in previous section.
7. Scrape and scrub wheels clean as needed.

# 8.0 OPERATION of the breadplant

## A OPERATION OF THE PROVER

Dough pieces are transferred from a divider via a chute to a carrier pocket in the prover. In auto mode the dough travels down the chute and into the pocket, an electronic eye is triggered which causes the carriers to move one position ready for the next dough piece.

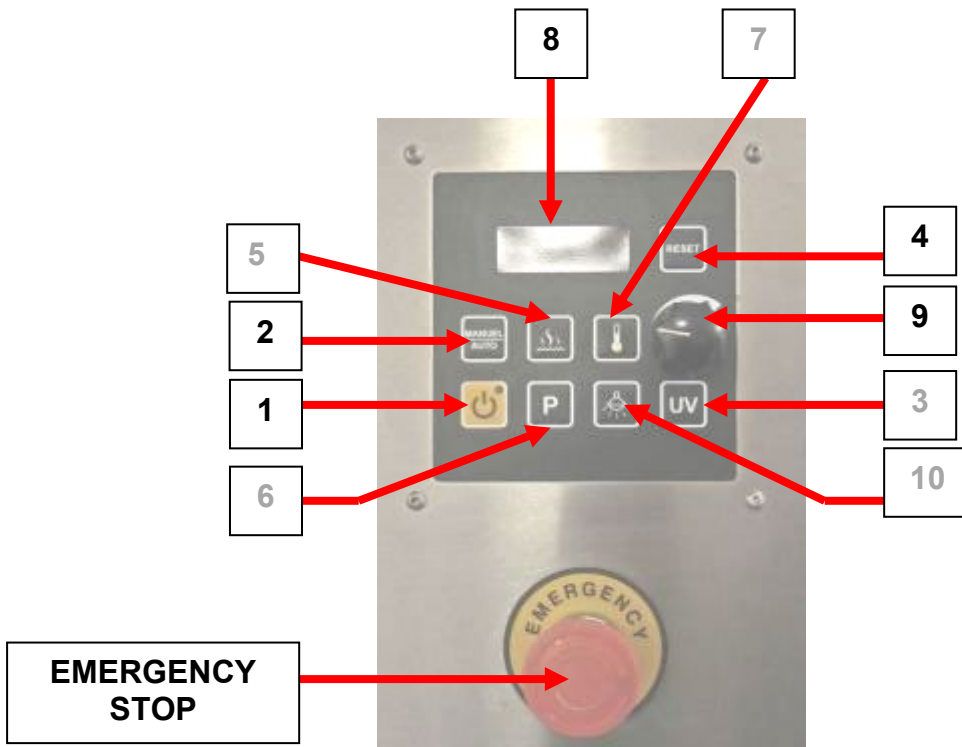

- 1. **START/STOP:** Start/Stop button  
*If the LED light is on, the machine is in manual operation mode.  
Press 2 to put machine into automatic mode (no light) if required.*

### MANUAL (Led is on):

This allows unloading the dough pieces after the divider has finished loading the prover.  
*In this mode it is possible to control the speed to match the moulders speed. By using button 9, speed adjustment is possible. Set at minimum there is no stop duration, machine operates continuously.*

**AUTO (Led is off):** Starts the prover in auto mode.  
*(No movement will happen until dough passes the sensor on the chute.)*

- 2. **Manual mode / Auto mode selection**
- 3. **UV** Controls the ultraviolet light.(if fitted)
- 4. **RESET:** When pressed resets the display(8)
- 5. **Steam** (if fitted)
- 6. **P:** Extra option button (not used)
- 7. Heat (if fitted)
- 8. Digital display
- 9. Speed control
- 10. Lamp (if fitted)

## **B How to operate the MONO BREADPLANT**

1. Ensure the prover power is connected and the main isolator is on.
2. Ensure that a divider is in position and plugged into the prover.  
(location differs depending on divider used)
3. Ensure the moulder is in position and plugged into the prover. Adjust the moulding settings for the product required.
4. Select auto mode (2) This is when the on/off switch (1) light is not illuminated. Press the “start” button (1) on the prover and the reset button (4). The prover will now be ready to receive dough.
5. Load the divider hopper with dough.
6. Start the divider (green button on divider) and adjust weights as instructed in the divider manual.
7. When satisfied with the dough weights, allow the dough to enter the prover. The prover will move to the next carrier every time it senses a dough piece.
8. If the divider is empty, push the manual button (2) and the on/off switch (1) light is illuminated. The prover will keep moving to prove the dough and empty to the moulder.
9. When the dough reaches the moulder, the moulded dough pieces should be collected and placed on trays or in tins as required.

### **NOTE**

**THE EMERGENCY STOP ON THE DIVIDER WILL STOP THE DIVIDER.**

**THE EMERGENCY STOP ON THE MOULDER WILL STOP THE MOULDER.**

**THE EMERGENCY STOP ON THE PROVER WILL STOP ALL MACHINES.**





# **FLOUR DUSTER OPERATION**

TO ENSURE AN EVEN FLOW, ONLY USE CLEAN, DRY FLOUR.



DUSTER LOCATION

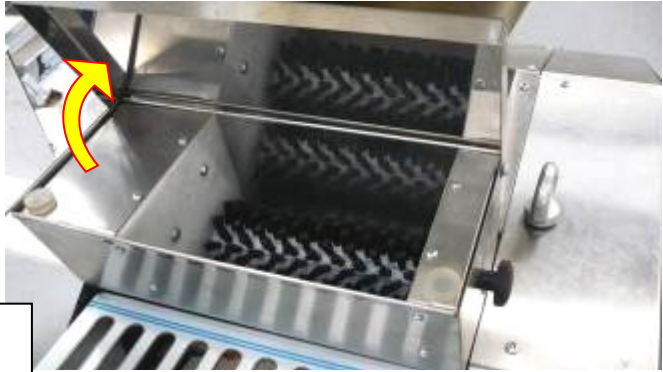

1

OPEN LID AND FILL WITH DRY FLOUR,  
THEN CLOSE THE LID



2

TURN ON POWER WHEN REQUIRED



3

ADJUST THE FLOW BY LOOSENING THE BLACK  
KNOB AND MOVING TO THE REQUIRED  
POSITION THEN RETIGHTEN KNOB.

## 9.0 MAINTENANCE

---



**WARNING**

- This appliance must be maintained at regular intervals. The frequency of maintenance will depend upon your specific use and location. The maximum service interval should be 12 months.
  - Service and maintenance should only be undertaken by suitably qualified, trained, and competent engineers.
  - You must immediately report any damage or defect arising with the appliance.
  - Unsafe equipment is dangerous. Do not use the appliance. Isolate the power supply and contact MONO or your appointed service agent.
- 



**WARNING**

- Isolate the machines from the mains supply before attempting any maintenance operations.
-

# SECTION 2

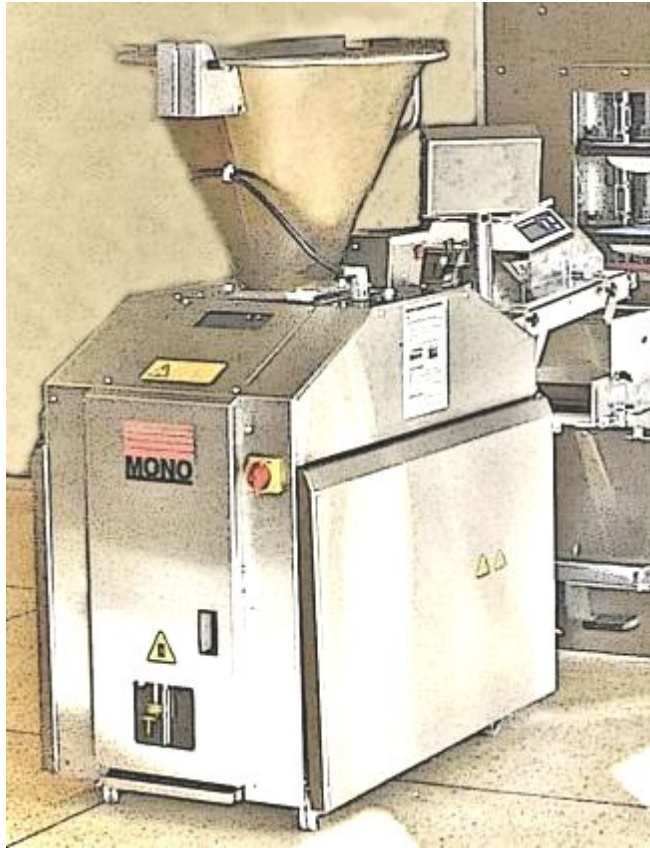

FULL OPERATING AND  
MAINTENANCE MANUAL  
FOR THE  
**FUSION BREADPLANT DIVIDER**

**DIVIDER** FULL INSTRUCTIONS

# IMPORTANT NOTES

**FAILURE TO KEEP TO THE CLEANING AND MAINTENANCE INSTRUCTIONS DETAILED IN THIS MANUAL COULD AFFECT THE WARRANTY and SAFETY OF THIS MACHINE**

**○ WARNING! --- DIVIDER OIL  
DO NOT USE ORDINARY VEGETABLE OIL FROM  
SHOP SHELVES, IN THE DIVIDER.**

*THIS WILL FORM A GUM-LIKE RESIDUE,  
CAUSING STICKING AND POSSIBLE DAMAGE TO THE MACHINE.*

MONO RECOMMENDS THE USE OF “**CRODA SUPER WUNDROL**”  
(AVAILABLE FROM MONO. **PART NUMBER “A900-25-272”**)

# CONTENTS – DOUGH DIVIDER

---

- 1.0 INTRODUCTION ..... 38
- 2.0 GENERAL DIMENSIONS..... 39
- 3.0 SPECIFICATIONS..... 39
- 4.0 SAFETY..... 40
- 5.0 INSTALLATION..... 41
- 6.0 ISOLATION ..... 43
- 7.0 CLEANING INSTRUCTIONS ..... 44
  - Daily.....44
  - Weekly .....48
- 8.0 OPERATING ..... 49
- 9.0 MAINTENANCE ..... 52
- 10.0 TROUBLESHOOTING ..... 54
- 11.0 SPARES AND SERVICE..... 61

---

**FOR SERVICE AND SPARES RING: 01792 564044**

---

- 12.0 ELECTRICAL INFORMATION SECTION ..... 62

# 1.0 INTRODUCTION

THE MONO DIVIDER is accurate, reliable and compact.

- It has a large capacity hopper, simple controls and adjustments.
- The in-line discharge gives a very compact machine.
- The dough divider has the capacity to accurately scale dough pieces, Between 8oz (250g) and 36 oz (1000g).

## THE DIVIDING PROCESS

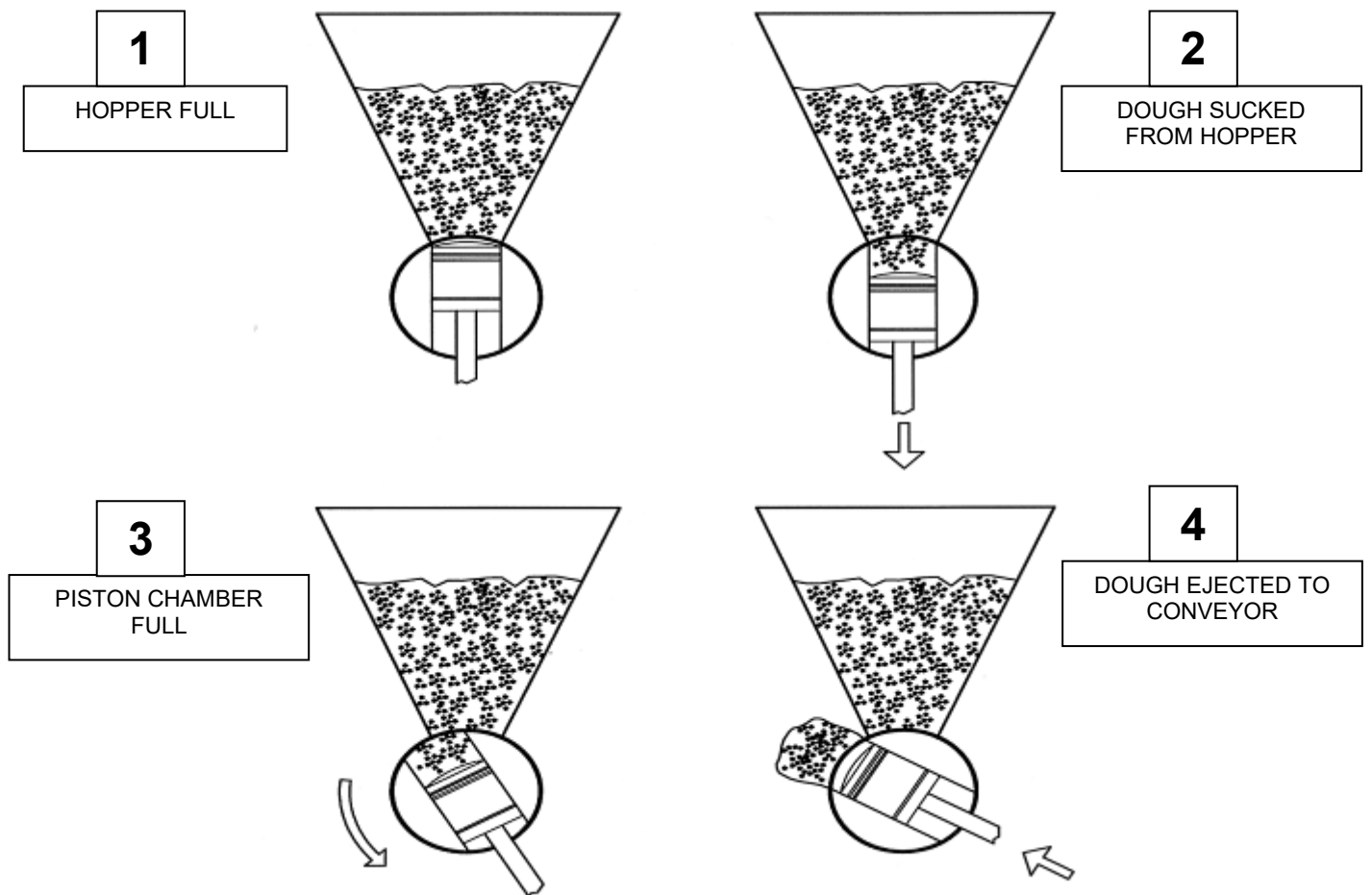

### NOTE

THE DIVIDER WORKS ON VOLUME NOT WEIGHT.

## 2.0 GENERAL DIMENSIONS

---

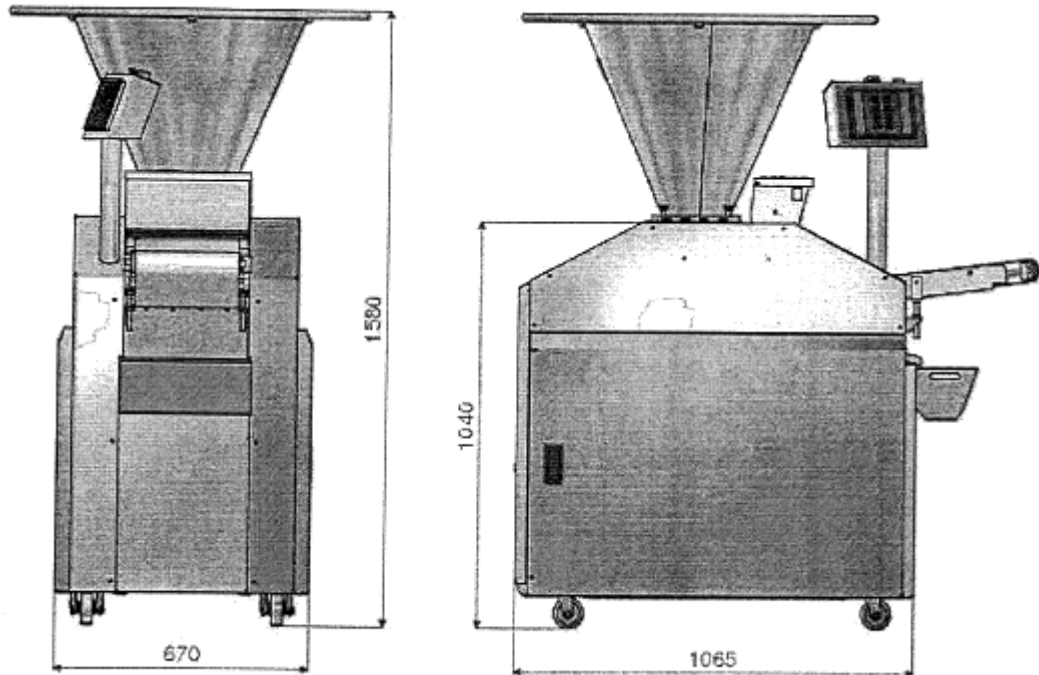

**Height:** 1580mm.

**Depth:** 1065mm. (inc. conveyor 1400mm)

**Width:** 670mm.

## 3.0 SPECIFICATIONS

---

**Total power:** 3.2kW, three phase + N + E, 415v /50Hz

**Capacity:** Accurately scaled dough pieces,  
between 250g and 1000g (8oz - 36oz).

**Weight:** 500kg.

**Noise Level:** Less than 85dB.

## 4.0 SAFETY



IF YOU ENCOUNTER ANY ISSUE WITH THIS EQUIPMENT THAT YOU HAVE NOT BEEN TRAINED FOR, YOU MUST CONTACT YOUR INSTORE TECHNICIAN.



- 1 **Never use a machine in a faulty condition** and always report any damage.
- 2 **Only trained engineers may remove any part** that requires a tool to do so.
- 3 **People undergoing training on the machine must be under direct supervision** of a fully trained person.
- 4 **Use of the machine can prove dangerous if:**
  - The machine is operated by untrained or unskilled staff
  - The machine is not used for its intended purpose
  - The machine is not operated correctly



- 5 **Always ensure hands are dry before touching any electrical appliance** (Including cable, switches and plugs).
- 6 **Do not operate the machine with any panels or guards removed.**
  - *All safety devices applied to the machine during manufacture and the operating instructions in this manual are required to operate this machine safely. The owner and the operator are responsible for operating this machine safely.*



- **DO NOT TRY TO DISABLE ANY SAFETY DEVICES, THEY ARE FITTED FOR YOUR SAFETY.**

- 7 **NEVER** move machinery by pulling on the power cords or cables.
- 8 **No loose clothing or jewellery** should be worn while operating the machine
- 9 **The bakery manager or the bakery supervisor must carry out daily safety checks** on the machine.
- 10 **No one under the age of 16 may operate** this machine.
- 11 **No-one under the age of 18 may clean** this machine under any circumstances.



- 12 **DO NOT STAND ON ANYTHING TO LOAD THE DIVIDER HOPPER.**

**WARNING:**

NEVER LEAVE MACHINE WITH DOUGH IN AS PRESSURES BUILD UP AS THE DOUGH PROVES.



**ALL CLEANING AND MAINTENANCE OPERATIONS MUST BE MADE WITH THE DIVIDER DISCONNECTED FROM THE POWER SUPPLY.**



## 5.0 INSTALLATION



### **DO NOT ATTEMPT TO LIFT THE DIVIDER BY HUMAN FORCE (LIFTING)**

- Use of a **forklift or crane** is recommended for lifting, or the machine can be pushed into position on the castors provided.
- **To lift with a forklift** - the machine must be secured to a pallet.
- **To lift with a crane** - lifting eyes are provided .



LIFTING EYES

***Check that the power rating on the serial number plate matches the supply that the machine is to be connect***

- Check machine after installation to ensure the belt moves in the correct direction indicated (see arrow in photo below).

*(If wrong - swap positions of any two of the three phase carrying wires in the plug.  
With a plant this should be factory set and not need to be done)*



- Fill oil tank to 2/3 level, with your company recommended food safe oil.

**WARNING!**

**DO NOT USE ORDINARY VEGETABLE OIL FROM SHOP SHELVES, IN THE DIVIDER. THIS WILL FORM A GUM-LIKE RESIDUE, CAUSING STICKING AND POSSIBLE DAMAGE TO THE MACHINE.**

MONO RECOMMENDS THE USE OF “**CRODA SUPER WUNDROL**”  
(AVAILABLE FROM MONO. **PART NUMBER “A900-25-272”**)

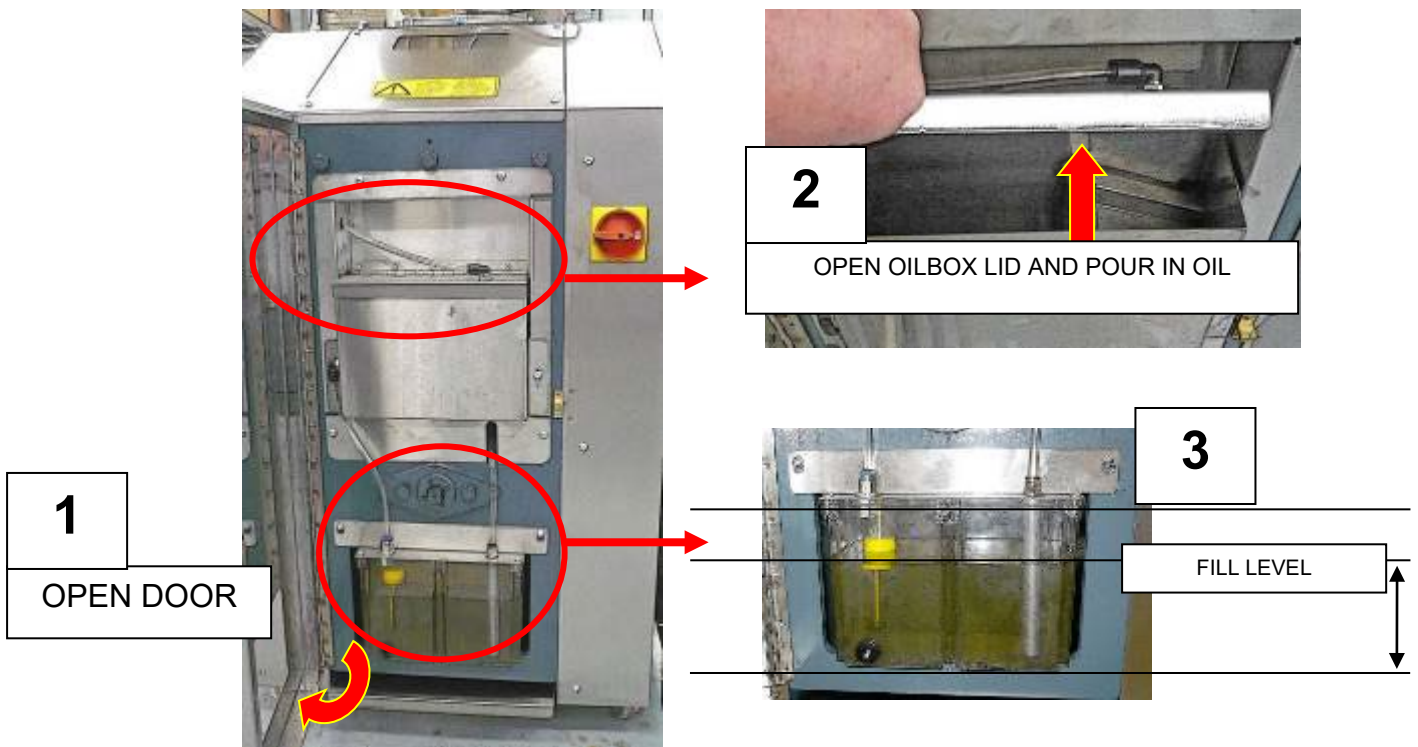

# 6.0 ISOLATION

---

TO STOP THE DOUGH DIVIDER IN AN EMERGENCY,  
Switch off at the PLANT MAIN ISOLATOR or use plant EMERGENCY BUTTON

OR

**DIVIDER MAIN ISOLATOR**



**The DIVIDER EMERGENCY STOP BUTTON.**



**EMERGENCY STOP BUTTON  
(TWIST TO RELEASE)**



# 7.0 CLEANING INSTRUCTIONS

## DAILY



NOTE:

**ISOLATE MACHINE FROM DIVIDER SUPPLY BEFORE CLEANING.**

- CLEANING SHOULD ONLY BE CARRIED OUT BY FULLY TRAINED PERSONNEL
- DO NOT USE A HIGH PRESSURE WASHER
- DO NOT USE SOLVENTS OF ANY KIND
- KEEP CLEANING FLUIDS AWAY FROM ELECTRICAL SWITCHES

1 Remove the dough residue from interior of the hopper.  
(Only use **plastic scraper**)

2 Smear interior of the hopper with divider oil.

4 Check oil level is correct. (See next page).

Then run the machine for a minute, using on/off buttons.  
(*This will stop the machine from seizing up by coating the drum with oil*)

**NOTE:**

**THE ABOVE STEPS MUST BE FOLLOWED DAILY,  
OTHERWISE IT WILL LEAD TO THE BUILD UP OF STARCH  
AND SEIZURE OF THE MACHINE.**

# OIL LEVEL CHECKING

- Fill oil tank to 2/3 level, with your company recommended food safe oil.

**WARNING!**  
**DO NOT USE ORDINARY VEGETABLE OIL FROM SHOP SHELVES, IN THE DIVIDER**  
*THIS WILL FORM A GUM-LIKE RESIDUE,  
CAUSING STICKING AND POSSIBLE DAMAGE TO THE MACHINE.*

MONO RECOMMENDS THE USE OF “CRODA SUPER WUNDROL”  
(AVAILABLE FROM MONO. PART NUMBER “A900-25-272”)

2



1  
OPEN DOOR



3  
FILL LEVEL



## • OFF TAKE CLEANING

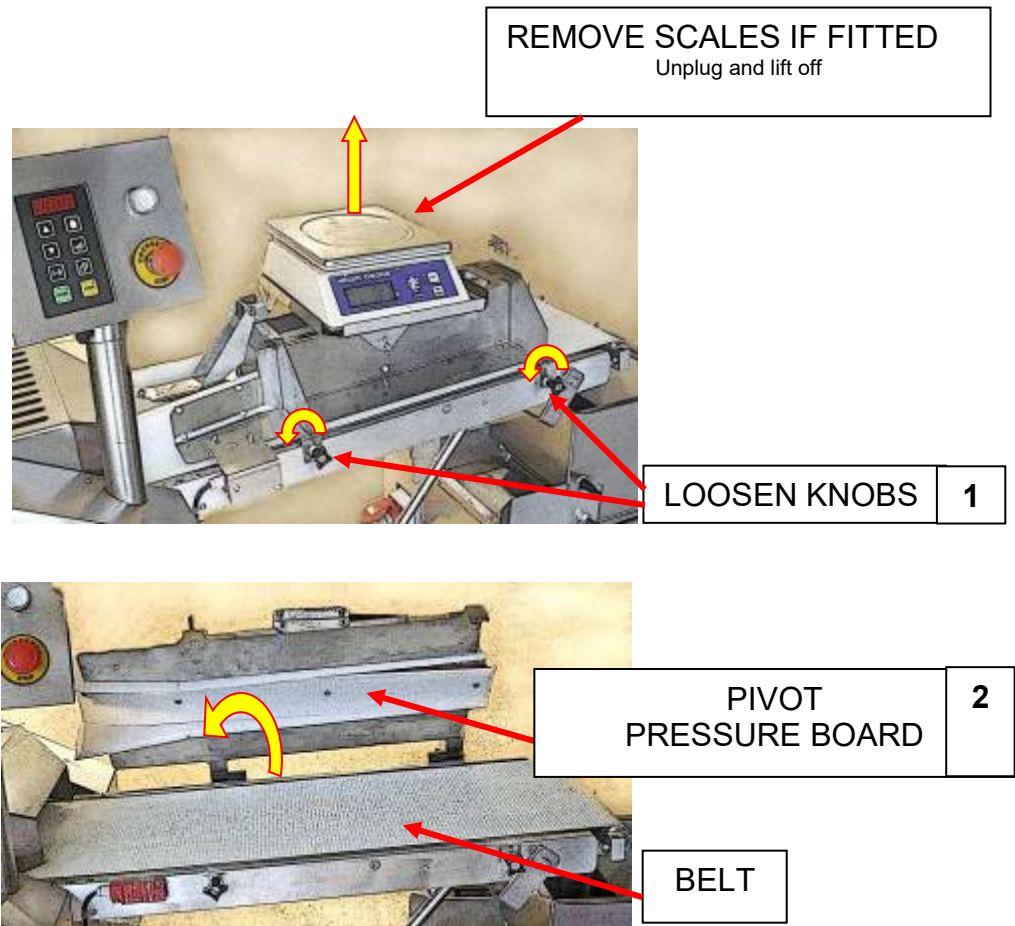

- 1 Unplug and remove the scales.
- 2 Loosen the two black knobs on the side of the pressure board.
- 3  Pivot the pressure board away from you.  
Help may be required to hold the pressure board while cleaning takes place.
- 4 Remove any dough residue and brush exposed parts.
- 5 Scrape and wipe down the belt. (Only use a **plastic scraper**).
- 6 Remove any dough residue from the conveyor metal work and belt surface.
- 7 Lower the pressure board and hand-tighten the two black knobs on the side of the pressure board.
- 8 Replace and plug in the scales.

## ▪ EXTERNAL CLEANING

- 1 Brush off any flour residue and scrape as necessary. (Only use a **plastic scraper**)
- 2 Brush off loosened dough.
- 3 Make up sterilising solution and hot water.
- 4 Clean the exterior of the divider as necessary, working from top to bottom.
- 5 Swab dry with disposable tissue.

## ▪ UNDER CONVEYOR COLLECTION BOX

- 1 Brush the chute debris into the collection box.

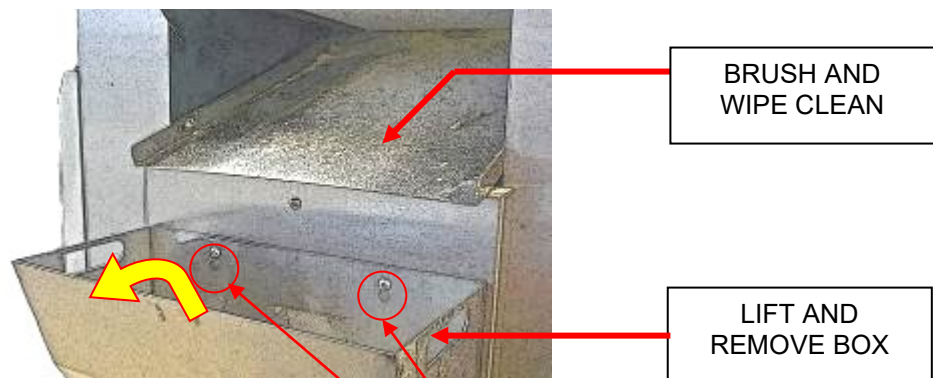

- 2 Lift and remove the collection box and clean.
- 3 Replace the collection box, making sure it is pushed right down on locating screws.

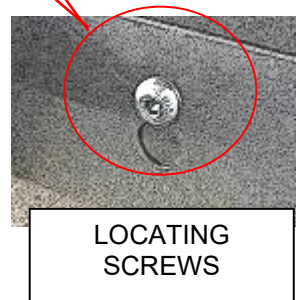

## **WEEKLY**

**NOTE:**

CLEANING SHOULD ONLY BE CARRIED OUT BY FULLY TRAINED PERSONNEL



**WARNING:  
ISOLATE MACHINE FROM MAINS SUPPLY**

1. Scrub wheels with a small nylon cleaning brush or scouring pad and hot water sterilising solution.
2. Clean entire exterior surfaces of the machine working from top to bottom.



# 8.0 OPERATING

- 1 Check intermediate prover is switched on.  
Press **START BUTTON (1)** on prover control panel.  
Ensure the led on the button is not illuminated.(if it is, press 2)  
This starts the prover in auto mode.  
(No movement will happen until dough passes the sensor on the chute.)

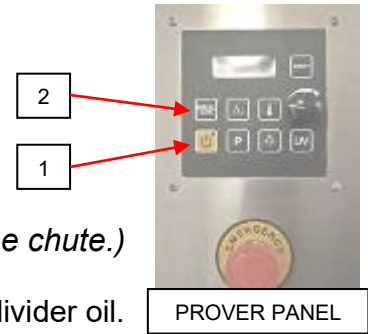

- 2 Check that the hopper is clear of objects and Smear interior with divider oil.

**WARNING!**

DO NOT USE ORDINARY VEGETABLE OIL FROM SHOP SHELVES, IN THE DIVIDER  
THIS WILL FORM A GUM-LIKE RESIDUE,  
CAUSING STICKING AND POSSIBLE DAMAGE TO THE MACHINE.

MONO RECOMMENDS THE USE OF "CRODA SUPER WUNDROL"  
(AVAILABLE FROM MONO. PART NUMBER "A900-25-272")

## CONTROL POD BUTTONS

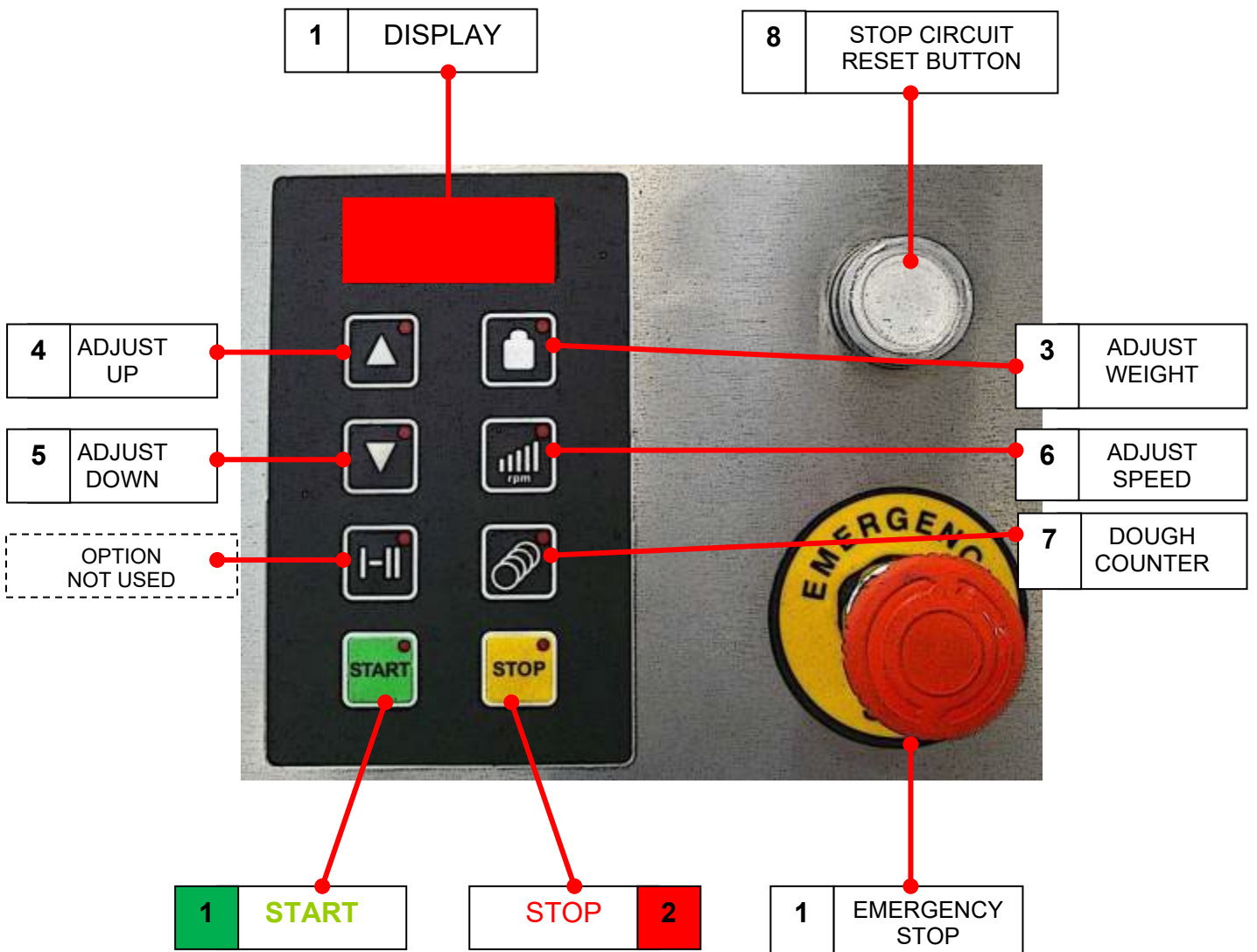

- 3 Run the divider for two minutes to allow oil to circulate. (Press “START” (1) )  
Then Stop the divider. (Press “STOP” (2) )

**Note:** *To prevent contamination, It is advisable to thoroughly check the hopper and off take conveyor for traces of a previous dough.*

- 4 Load dough into the hopper.
- 5 Run the machine (Press “START” (1) ) and check the first dough pieces out of the discharge conveyor for weight and cleanliness.

Adjust weight by pressing the “weight adjust button” (3) and then use the “adjust up” button (4) or the “adjust down” button (5) to alter the weight.  
Make a note of the number showing in the display window for future reference.

(NOTE the number is only a reference to the setting and is not an indicator of weight, size etc.)

**(REPLACE CLEAN DOUGH INTO THE HOPPER. DO NOT PUT BACK ON CONVEYOR)**

*Normally the first six dough pieces are put back into the hopper, as weight consistency is suspect in the initial dough pieces.*

*If any dough pieces are contaminated with excess oil or traces of previous doughs e.g. Wholemeal, discard accordingly.*

- 6 Run dough through the divider.  
Care must be taken with weights, especially towards the end of a batch of dough.
- 7 Check the oil level in the tank frequently throughout shift and top up, if required.

**Note:** - *The divider is a volume divider that divides by size of dough piece, not by weight.*

***Be aware that dough is a “live” product and will expand in size during the dividing Process, so check-weigh adjustments will have to be made during a batch of dough.***



**WARNING!**

**NEVER LEAVE DIVIDER WITH DOUGH INSIDE, PRESSURES CAN BUILD UP AS THE DOUGH PROVES**

# **FLOUR DUSTER OPERATION**

TO ENSURE AN EVEN FLOW, ONLY USE CLEAN, DRY FLOUR.



DUSTER LOCATION

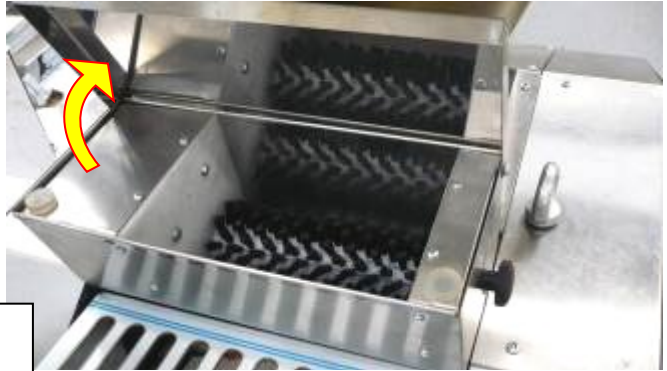

1

OPEN LID AND FILL WITH DRY FLOUR,  
THEN CLOSE THE LID



2

TURN ON POWER WHEN REQUIRED



3

ADJUST THE FLOW BY LOOSENING THE  
BLACK KNOB AND MOVING TO THE  
REQUIRED POSITION. RETIGHTEN KNOB.

## 9.0 MAINTENANCE

---



### WARNING

- This appliance must be maintained at regular intervals. The frequency of maintenance will depend upon your specific use and location. The maximum service interval should be 12 months.
- Service and maintenance should only be undertaken by suitably qualified, trained, and competent engineers.
- You must immediately report any damage or defect arising with the appliance.
- Unsafe equipment is dangerous. Do not use the appliance. Isolate the power supply and contact MONO or your appointed service agent.



### WARNING

- Isolate the machine from the mains supply before attempting any maintenance operations.

Due to the low maintenance design of the divider, maintenance consists of the operations in the cleaning section and a few of the following checks:

- Conveyor belt adjustment (as required).
- Condition and greasing (check monthly)
- Weight adjuster chain condition and greasing (check monthly)

### Conveyor Belt Adjustment

Conveyor belt should be no tighter than necessary to eliminate slippage.

Over tensioning can lead to belt and/or bearing failure. The belt should be adjusted by means of the adjustment tensioning nuts.

The belt should run with equal clearance between its edges and the conveyor unit side frames. If one edge of the belt is tighter than the other, it will tend to run towards the slack side. This tracking defect can be eliminated by individual adjustment of the tensioning nuts.

#### Caution

Adjustment nuts should not be continually tightened (this will cause bearing failure or the moulding belt to stretch and break). It may be that one side is too tight so should be eased off a little.

**ADJUSTMENT NUTS**  
(each side)

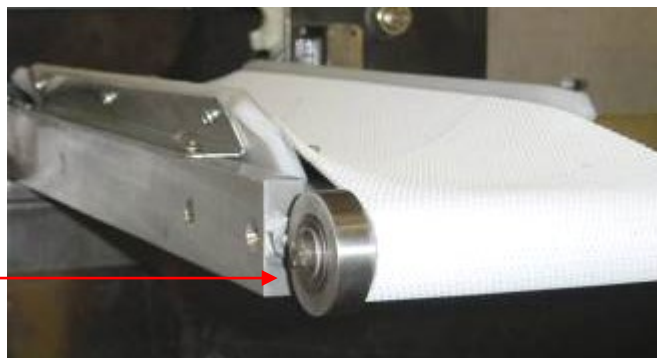

## Chain greasing



- Open the side panels. (Remove 2 fixing screws each side and swing open).
- Check that the main drive and weight adjusting chains are clean and greased.

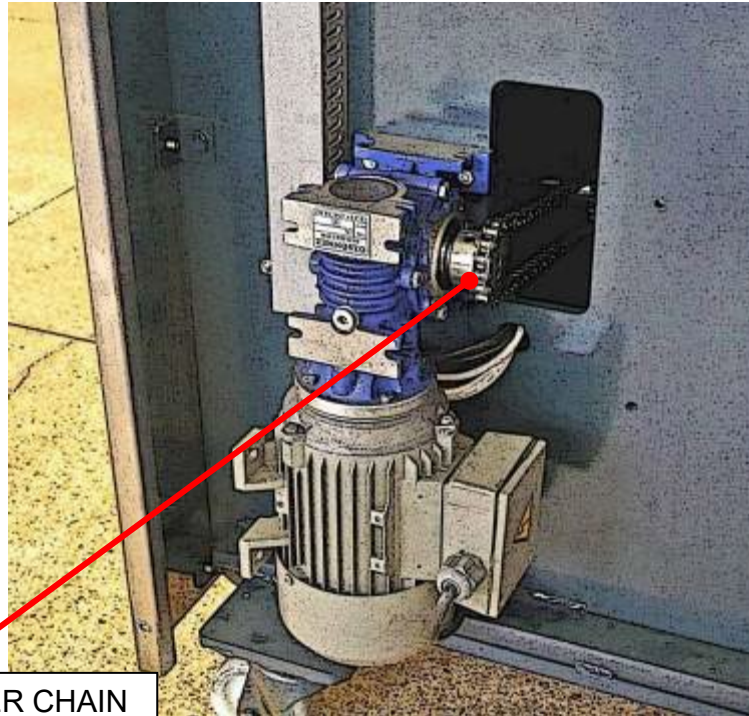

WEIGHT ADJUSTER CHAIN

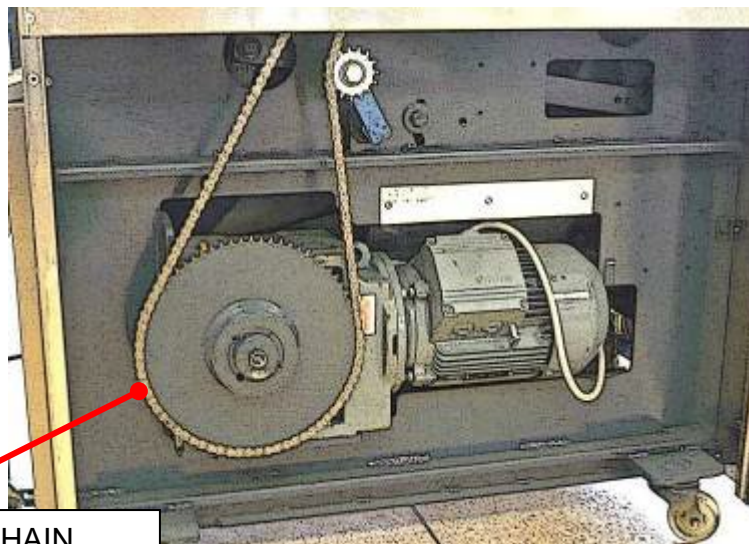

MAIN DRIVE CHAIN

# 10.0 TROUBLESHOOTING

---

## Divider does not run

- Check power is turned on at the isolator on the prover.  
*Check that the plant is connected and turned on.*  
*Check plug into intermediate prover is correctly connected.*
- Check all safety switches are operating (hopper closed etc.).
- Check a red “stop button” is not depressed (Turn to release.)  
and that stop circuit reset button (8) has been pressed.

**WARNING: IF THERE IS ANY POSSIBILITY OF DAMAGE TO PLUGS OR LEADS, ISOLATE DIVIDER FROM PROVER BEFORE CHECKING.**



If divider still does not function after carrying out these checks,  
call out “Mono” service dept.

## ◆ General Fault and Alarms

Faults and alarms indicate problems in the drive or in the machine.

An alarm is indicated by a code on the data display and the flashing ALM LED. The drive output is not necessarily switched off.

A fault is indicated by a code on the data display and the ALM LED is on. The drive output is always switched off immediately and the motor coast to stop.

To remove an alarm or reset a fault, trace the cause, remove it and reset the drive by pushing the Reset key on the operator or cycling the power supply.

This lists up the most important alarms and faults only. Please refer to the Technical Manual for a complete list.

| LED Display                                | AL | FLT | Cause  | Corrective Action   |
|--|----|-----|--|---|
| Base Block<br>bb                           | ○  |     | The software base block function is assigned to one of the digital inputs and the input is off. The drive does not accept Run commands.  | <ul style="list-style-type: none"> <li>• Check the digital inputs function selection.</li> <li>• Check the upper controller sequence.</li> </ul>  |
| Control Fault<br>CF                        |    | ○   | The torque limit was reached during deceleration for longer than 3 sec. when in Open Loop Vector control <ul style="list-style-type: none"> <li>• The load inertia is too big.</li> <li>• The torque limit is too low.</li> <li>• The motor parameters are wrong.</li> </ul> | <ul style="list-style-type: none"> <li>• Check the load.</li> <li>• Set the torque limit to the most appropriate setting (L7-01 through L7-04).</li> <li>• Check the motor parameters.</li> </ul> |
| Control Circuit Fault<br>[PF02 to<br>[PF24 |    | ○   | There is a problem in the drive's control circuit.   | <ul style="list-style-type: none"> <li>• Cycle the drive power supply.</li> <li>• Initialize the drive.</li> <li>• Replace the drive if the fault occurs again.</li> </ul>                        |
| Control Circuit Fault<br>[PF25             |    | ○   | There is no terminal board connected to the control board.   | <ul style="list-style-type: none"> <li>• Check if the terminal board is installed properly.</li> <li>• Uninstall and Reapply the terminal board.</li> <li>• Change the drive.</li> </ul>          |
| Cannot Reset<br>[r5f                       | ○  |     | Fault reset was input when a Run command was active.   | Turn off the Run command and reset the drive.   |
| Option External Fault<br>EF                | ○  | ○   | An external fault was tripped by the upper controller via an option card.  | <ul style="list-style-type: none"> <li>• Remove the fault cause, reset the fault and restart the drive.</li> <li>• Check the upper controller program.</li> </ul>                                 |
| External Fault<br>EF                       | ○  |     | A forward and reverse command were input simultaneously for longer than 500 ms. This alarm stops a running motor.  | <ul style="list-style-type: none"> <li>• Check the sequence and make sure that the forward and reverse input are not set at the same time.</li> </ul>   |

| LED Display                            | AL | FLT | Cause  | Corrective Action   |
|--|----|-----|--|---|
| External Faults<br><i>EF 1 to EF6</i>  | ○  | ○   | <ul style="list-style-type: none"> <li>An external fault was triggered by an external device via one of the digital inputs S1 to S6.</li> <li>The digital inputs are set up incorrectly.</li> </ul>  | <ul style="list-style-type: none"> <li>Find out why the device tripped the EF. Remove the cause and reset the fault.</li> <li>Check the functions assigned to the digital inputs.</li> </ul>  |
| Ground Fault<br><i>GF</i>              |    | ○   | <ul style="list-style-type: none"> <li>Ground leakage current has exceeded 50% of the drives rated output current.</li> <li>Cable or motor insulation is broken.</li> <li>Excessive stray capacitance at drive output.</li> </ul>  | <ul style="list-style-type: none"> <li>Check the output wiring and the motor for short circuits or broken insulation. Replace any broken parts.</li> <li>Reduce the carrier frequency.</li> </ul>   |
| Safe Disable<br><i>Hbb</i>             | ○  |     | Both Safe Disable inputs are open. The drive output is safely disabled and the motor can not be started.   | <ul style="list-style-type: none"> <li>Check why the upper controller's safety device disabled the drive. Remove the cause and restart.</li> <li>Check the wiring.</li> <li>If the Safe Disable function is not utilized for EN60204-1, stop cat. 0 or for disabling the drive, the terminals HC, H1, H2 must be linked.</li> </ul>     |
| Safe Disable Fault<br><i>HbbF</i>      | ○  |     | <p>Drive output is disabled while only one of the Safe Disable inputs is open. (normally both input signals H1 and H2 should be open)</p> <ul style="list-style-type: none"> <li>One channel is internally broken and does not switch off, even if the external signal is removed.</li> <li>Only one channel is switched off by the upper controller.</li> </ul> | <ul style="list-style-type: none"> <li>Check the wiring from the upper controller and make sure that both signals are set correctly by the controller.</li> <li>If the signals are set correctly and the alarm does not disappear, replace the drive.</li> </ul>  |
| Output Phase Loss<br><i>PF</i>         |    | ○   | <p>Output cable is disconnected or the motor winding is damaged.</p> <p>Loose wires at the drive output.</p> <p>Motor is too small (less than 5% of drive current).</p>  | <ul style="list-style-type: none"> <li>Check the motor wiring.</li> <li>Make sure all terminal screws in the drive and motor are properly tightened.</li> <li>Check the motor and drive capacity.</li> </ul>  |
| Overcurrent<br><i>oC</i>               |    | ○   | <p>Short circuit or ground fault on the drive output side</p> <p>The load is too heavy.</p> <p>The accel./decel. times are too short.</p> <p>Wrong motor data or V/f pattern settings.</p> <p>A magnetic contactor was switched at the output.</p>   | <ul style="list-style-type: none"> <li>Check the output wiring and the motor for short circuits or broken insulation. Replace the broken parts.</li> <li>Check the machine for damages (gears, etc.) and repair any broken parts.</li> <li>Check the drive parameter settings.</li> <li>Check the output contactor sequence.</li> </ul> |
| Heatsink Overheat<br><i>oH or oH 1</i> | ○  | ○   | <p>Surrounding temperature is too high.</p> <p>The cooling fan has stopped.</p> <p>The heatsink is dirty.</p> <p>The airflow to the heatsink is restricted.</p>  | <ul style="list-style-type: none"> <li>Check the surrounding temperature and install cooling devices if necessary.</li> <li>Check the drive cooling fan.</li> <li>Clean the heatsink.</li> <li>Check the airflow around the heatsink.</li> </ul>  |
| Motor Overload<br><i>oL 1</i>          |    | ○   | <p>The motor load is too heavy.</p> <p>The motor is operated at low speed with heavy load.</p> <p>Cycle times of accel./ decel. are too short.</p> <p>Incorrect motor rated current has been set.</p>  | <ul style="list-style-type: none"> <li>Reduce the motor load.</li> <li>Use a motor with external cooling and set the correct motor in parameter L1-01</li> <li>Check the sequence.</li> <li>Check the rated current setting.</li> </ul>   |



| LED Display                           | AL | FLT | Cause  | Corrective Action  |
|---------------------------------------|----|-----|--|--|
| Drive Overload<br><i>OL2</i>          |    | ○   | The load is too heavy.<br>The drive capacity is too small.<br>Too much torque at low speed.  | <ul style="list-style-type: none"> <li>• Check the load.</li> <li>• Make sure that the drive is big enough to handle the load.</li> <li>• The overload capability is reduced at low speeds. Reduce the load or increase the drive size.</li> </ul>   |
| DC Overvoltage<br><i>OU</i>           | ○  | ○   | DC bus voltage rose too high.<br>The deceleration time is too short.<br>Stall prevention is disabled.<br>Braking chopper / resistor broken.<br>Unstable motor control in OLV.<br>Too high input voltage. | <ul style="list-style-type: none"> <li>• Increase the deceleration time.</li> <li>• Enable stall prevention by parameter L3-04.</li> <li>• Make sure the braking resistor and braking chopper are working correctly.</li> <li>• Check motor parameter settings and adjust torque and slip compensation, AFR and hunting prevention as needed.</li> <li>• Make sure that the power supply voltage meets the drives specifications.</li> </ul> |
| Input Phase Loss<br><i>LF</i>         |    | ○   | Input voltage drop or phase imbalance.<br>One of the input phase is lost.<br>Loose wires at the drive input.   | <ul style="list-style-type: none"> <li>• Check the power supply.</li> <li>• Make sure that all cables are properly fixed to the correct terminals.</li> </ul>  |
| Braking Transistor Fault<br><i>rr</i> |    | ○   | The internal braking transistor is broken.   | <ul style="list-style-type: none"> <li>• Cycle the power supply.</li> <li>• Replace the drive if the fault reoccurs.</li> </ul>  |
| DC Undervoltage<br><i>UU1</i>         | ○  | ○   | The voltage in the DC bus fell below the undervoltage detection level (L2-05).<br>The power supply failed or one input phase has been lost.<br>The power supply is too weak.                             | <ul style="list-style-type: none"> <li>• Check the power supply.</li> <li>• Make sure, that the power supply is strong enough.</li> </ul>  |
| Controller Undervoltage<br><i>UU2</i> |    | ○   | The drives controller power supply voltage is too low.   | <ul style="list-style-type: none"> <li>• Cycle power to the drive. Check if the fault reoccurs.</li> <li>• Replace the drive if the fault continues to occur.</li> </ul>   |
| DC Charge Circuit Fault<br><i>UU3</i> |    | ○   | The charge circuit for the DC bus is broken.   | <ul style="list-style-type: none"> <li>• Cycle power to the drive. Check if the fault reoccurs.</li> <li>• Replace the drive if the fault reoccurs.</li> </ul>   |

## ◆ Operator Programing Errors

An Operator Programming Error (OPE) occurs when an inapplicable parameter is set or a individual parameter setting is inappropriate. When an OPE error is displayed, press the ENTER button to display U1-18 (OPE fault constant). This monitor will display the parameter that is causing the OPE error.

| LED Operator Display | Cause  | Corrective Action  |
|----------------------|--|--|
| oPE01<br>oPE01       | Drive capacity and value set to o2-04 do not match.  | Correct the value set to o2-04.  |
| oPE02<br>oPE02       | Parameters were set outside the allowable setting range.   | Set parameters to the proper values.   |
| oPE03<br>oPE03       | A contradictory setting is assigned to multi-function contact inputs H1-01 through to H1-06. <ul style="list-style-type: none"> <li>• The same function is assigned to two inputs. (this excludes "External fault" and "Not used")</li> <li>• Input functions which require the setting of other input functions were set alone.</li> <li>• Input functions that are not allowed to be used simultaneously have been set.</li> </ul> | <ul style="list-style-type: none"> <li>• Fix any incorrect settings.</li> <li>• Refer to the Technical Manual for more detail</li> </ul>     |
| oPE05<br>oPE05       | <ul style="list-style-type: none"> <li>• The run command source (b1-02) or frequency reference source (b1-01) is set to 3 but no option board is installed.</li> <li>• The frequency reference source is set to pulse input but H6-01 is not 0.</li> </ul>   | <ul style="list-style-type: none"> <li>• Install the required option board.</li> <li>• Correct the values set to b1-01 and b1-02.</li> </ul> |
| oPE07<br>oPE07       | Settings to multi-function analog inputs H3-02 and H3-10 and PID functions conflict. <ul style="list-style-type: none"> <li>• H3-02 and H3-10 are set to the same value. (this excludes settings "0" and "F")</li> <li>• PID functions have been assigned to both analog inputs and the pulse input at the same time.</li> </ul>   | <ul style="list-style-type: none"> <li>• Fix any incorrect setting.</li> <li>• Refer to the Technical Manual for more detail</li> </ul>      |
| oPE08<br>oPE08       | A function has been set that cannot be used in the control mode selected.(might appear after control mode change)  | <ul style="list-style-type: none"> <li>• Fix any incorrect setting.</li> <li>• Refer to the Technical Manual for more detail</li> </ul>      |
| oPE10<br>oPE 10      | The V/f pattern setting is incorrect.  | <ul style="list-style-type: none"> <li>• Check the V/f pattern settings.</li> <li>• Refer to the Technical Manual for more detail</li> </ul> |

## ◆ Auto-Tuning Errors

| LED Operator Display  | Cause   | Corrective Action  |
|-----------------------|---|--|
| Er-01<br><i>Er-01</i> | Motor data fault<br>The input motor data are not valid, (e.g. the base frequency and base speed do not fit).  | Re-enter the data and repeat Auto-Tuning.  |
| Er-02<br><i>Er-02</i> | Minor Fault<br>• The wiring is faulty.<br>• The load is too heavy.  | • Check the wiring.<br>• Check the load. Always perform Auto-Tuning with the load decoupled from the motor.  |
| Er-03<br><i>Er-03</i> | The STOP button was pressed and Auto-Tuning was canceled.   | Repeat the Auto-Tuning.  |
| Er-04<br><i>Er-04</i> | Resistance fault<br>• Wrong input data.<br>• Auto tuning exceeded the given time frame.<br>• Calculated values out of range.                                      | • Check the input data.<br>• Check the wiring.<br>• Re-enter the data and repeat the Auto-Tuning.  |
| Er-05<br><i>Er-05</i> | No-Load Current Error<br>• Incorrect data was entered.<br>• Auto tuning took too long.<br>• Calculated values out of range.                                       |  |
| Er-08<br><i>Er-08</i> | Rated Slip Error<br>• Wrong data input.<br>• Auto tuning exceeded the given time frame.<br>• Calculated values out of range.                                      |  |
| Er-09<br><i>Er-09</i> | Acceleration error<br>The motor did not accelerate for the specified acceleration time.   | • Increase the acceleration time C1-01.<br>• Check the torque limits L7-01 and L7-02.  |
| Er-11<br><i>Er-11</i> | Motor speed fault.<br>The torque reference was too high.  | • Increase the acceleration time (C1-01).<br>• If possible, disconnect the load.   |
| Er-12<br><i>Er-12</i> | Current detection error<br>• One or all output phases are lost.<br>• Current is either too low or exceeds the drives rating.<br>• The current sensors are faulty. | • Check the wiring.<br>• Make sure, that the drive rating fits to the motor.<br>• Check the load. (Auto-Tuning should have been performed without the load connected.)<br>• Replace the drive. |
| End1<br><i>End1</i>   | Rated current alarm<br>• The torque reference exceeded 20% during Auto-Tuning.<br>• The calculated no-load current is above 80% of the motor rated current.       | • Check the V/f pattern setting.<br>• Perform Auto-Tuning without the load connected.<br>• Check the input data and repeat Auto-Tuning.  |
| End2<br><i>End2</i>   | Motor iron-core saturation alarm<br>• Calculated core saturation values out of range.<br>• Incorrect data was entered.  | • Check the input data.<br>• Check the motor wiring.<br>• Perform Auto-Tuning without load connected.  |
| End3<br><i>End3</i>   | Rated current alarm   | Check the input data and repeat tuning.  |

# YASKAWA INVERTER DEFAULT SETTINGS

|       | 3KW    |
|-------|--------|
| A1 03 | 2220   |
| A1 02 | 0 2    |
| C1 01 | 0001.0 |
| C1 02 | 0000.5 |
| C4 02 | 000.30 |
| C6 02 | 0 5    |
| D2 02 | 033.0  |
| E2 01 | 014.40 |
| E1 04 | 060.0  |
| H2 01 | 000    |
| H3 03 | 0048.0 |
| H3 04 | 0015.0 |
| H3 13 | 1,3 0  |
| L1 01 | 03     |
| L8 07 | 0 2    |

## 11.0 SPARES AND SERVICE ---

If a fault arises, please do not hesitate to contact the Customer Service Department, quoting the **machine serial number** on the silver information plate of the machine and on the front cover of this manual

### SPARES and OVERSEAS SUPPORT:

#### MONO

Queensway  
Swansea West Industrial Estate  
Swansea. SA5 4EB UK

**email: [spares@monoequip.com](mailto:spares@monoequip.com)**  
**Web site: [www.monoequip.com](http://www.monoequip.com)**

**Tel. 01792 561234**  
**Fax. 01792 561016**

## 12.0 ELECTRICAL INFORMATION —

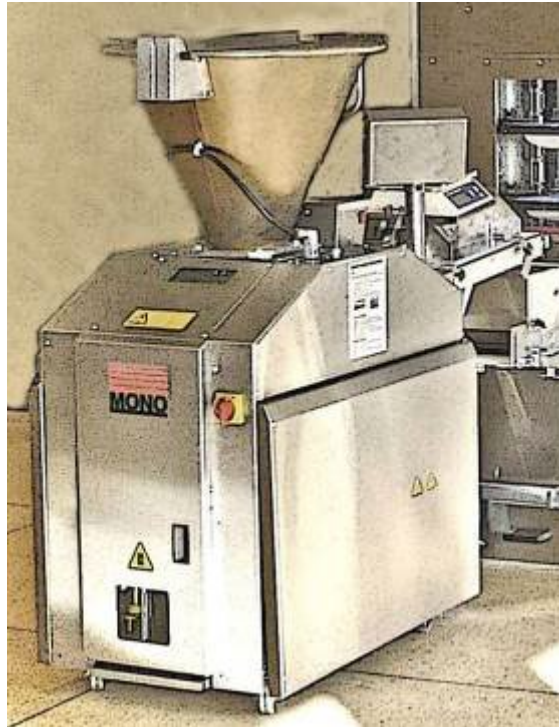

**Note**

Due to continual improvements this section may not be correct for your model. Please contact MONO before using.







# EMERGENCY STOP MONITORING CIRCUIT

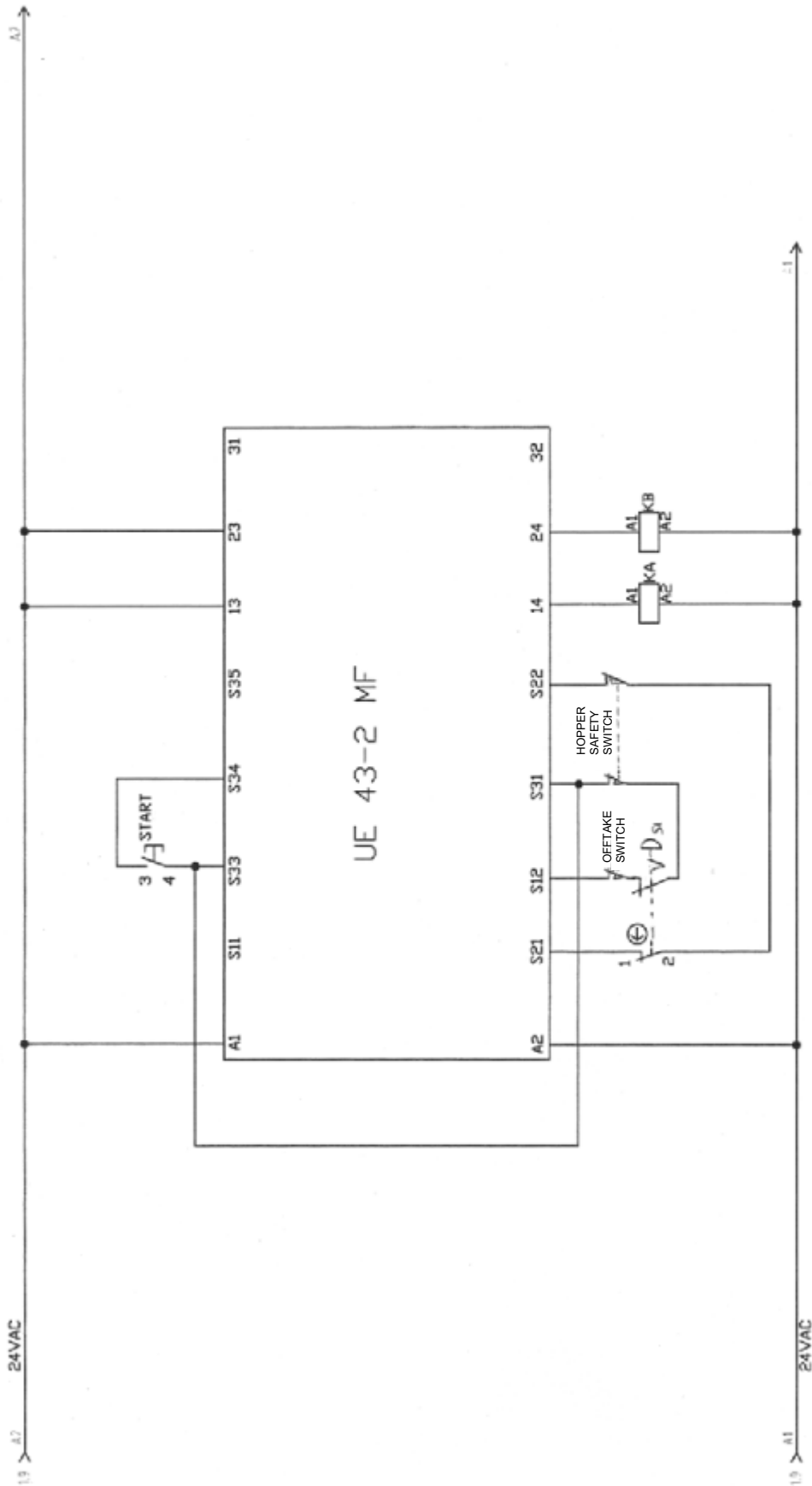

# SECTION 3



MOULDER

FULL OPERATING AND  
MAINTENANCE MANUAL  
FOR THE  
**BREADPLANT METRO MOULDER**

# **IMPORTANT NOTES**

**IF YOU ENCOUNTER ANY ISSUE WITH THIS EQUIPMENT THAT YOU HAVE NOT BEEN TRAINED FOR, YOU MUST CONTACT YOUR INSTORE TECHNICIAN.**

**Ensure the moulder is set up and adequate tins and trays are available before starting the breadplant.**

# CONTENTS – MOULDER

---

|      |                              |    |
|------|------------------------------|----|
| 1.0  | INTRODUCTION .....           | 69 |
| 2.0  | DIMENSIONS .....             | 69 |
| 3.0  | SPECIFICATIONS .....         | 70 |
| 4.0  | SAFETY .....                 | 71 |
| 5.0  | INSTALLATION .....           | 72 |
| 6.0  | ISOLATION .....              | 73 |
| 7.0  | CLEANING .....               | 74 |
|      | ▪ Daily .....                | 74 |
|      | ▪ Weekly .....               | 76 |
| 8.0  | OPERATING INSTRUCTIONS ..... | 77 |
| 9.0  | TROUBLESHOOTING .....        | 81 |
| 10.0 | SPARES AND SERVICE .....     | 82 |

---

**FOR SERVICE AND SPARES RING: 01792 564044**

---

|      |                              |    |
|------|------------------------------|----|
| 11.0 | ELECTRICAL INFORMATION ..... | 84 |
| 12.0 | MAINTENANCE .....            | 87 |

# 1.0 INTRODUCTION

---

The metro moulder has been designed with reliability and ease of operation in mind. Fully interlocked guards and covers ensure that semi-skilled personnel can safely operate this versatile machine, which has a maximum output of 1200 dough pieces an hour.

The double sheeting rolls give a gentle two stage reduction of the dough and two curling chains give greatly improved consistency of shape and size to the moulded dough piece. Windows at the front and rear of the machine allow the operator to monitor the progress of the dough right through the moulder.

# 2.0 DIMENSIONS

---

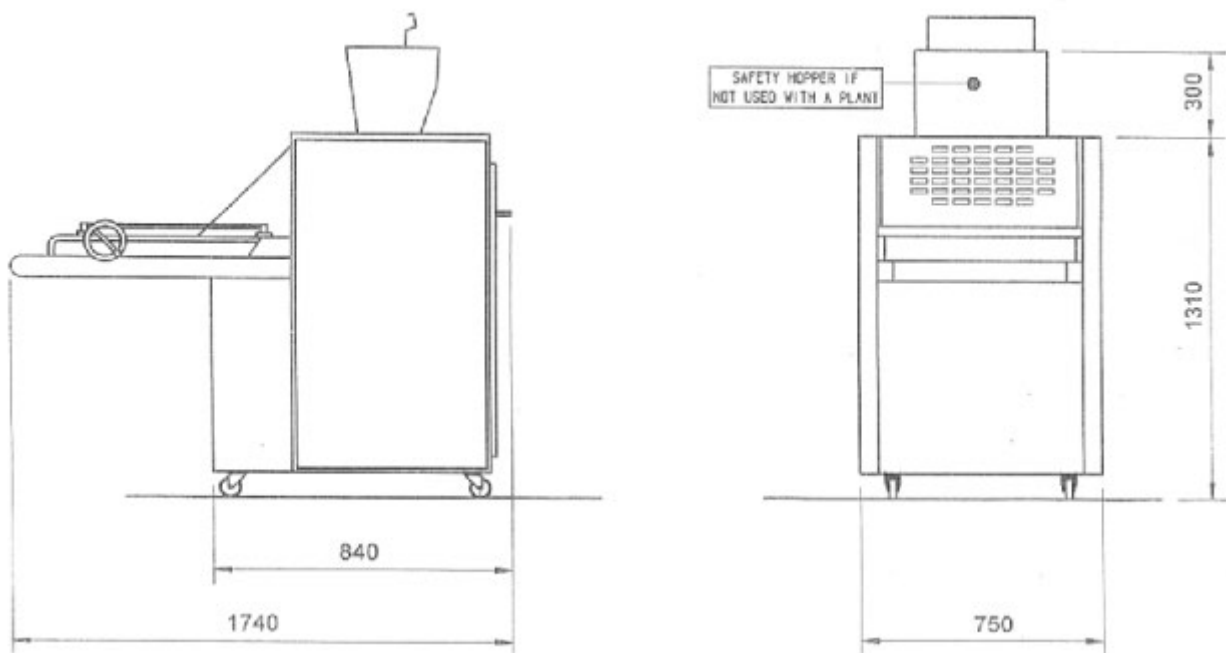

|               |                                |
|---------------|--------------------------------|
| <b>HEIGHT</b> | <b>1310mm (WITHOUT HOPPER)</b> |
| <b>WIDTH</b>  | <b>750mm</b>                   |
| <b>LENGTH</b> | <b>1740mm</b>                  |

# 3.0 SPECIFICATIONS

---

**CAPACITY:** Dough piece weight range – 56grms to 1.8Kg – (2oz to 4lbs)

**OUTPUT:** Up to 1200 pieces per hour

**POWER:** 0.75kW, 3 phase and neutral

**WEIGHT:** 230kg (507lbs)

**NOISE LEVEL:** Less than 85dB

## 4.0 SAFETY



- 1 **Never use a machine in a faulty condition** and always report any damage.
- 2 **No-one under the age of 16 may operate** this machine.
- 3 **No-one under the age of 18 may clean** this machine under any circumstances.
- 4 **Only trained personnel may remove any part** from this machine that requires a tool to do so.



- 5 **Always ensure hands are dry** before touching any electrical appliance (including cable, switch and plug).

- 6 **All operatives must be fully trained.**

- 7 People undergoing training on the machine must be under direct supervision.

- 8 **Do not operate the machine with any panels removed.**

- 9 **All guards must be fixed in place with bolts or screws** unless protected by a safety switch.

- 10 **No loose clothing or jewellery** to be worn while operating the machine.



- 11 **Switch off power at the mains isolator when machine is not in use** and before carrying out any cleaning or maintenance.

- 12 The pressure board adjusting handle, side guide adjuster handle and dough sheet roller gap lever may be adjusted while the machine is running.



**ALL OTHER CLEANING AND MAINTENANCE OPERATIONS MUST BE MADE WITH MACHINE DISCONNECTED FROM THE POWER SUPPLY**



**DO NOT ATTEMPT TO CLEAN THE MOULDING BELT WHEN THE MACHINE IS RUNNING**

- 13 The Bakery Manager or the Bakery Supervisor must carry out daily safety checks on the machine.



**WARNING:**

Hand or bodily contact with moving belt surfaces may cause friction burns to skin. This situation need not occur to successfully operate the moulder

## 5.0 INSTALLATION

---

1. The Metro moulder should be connected to a socket on the prover.

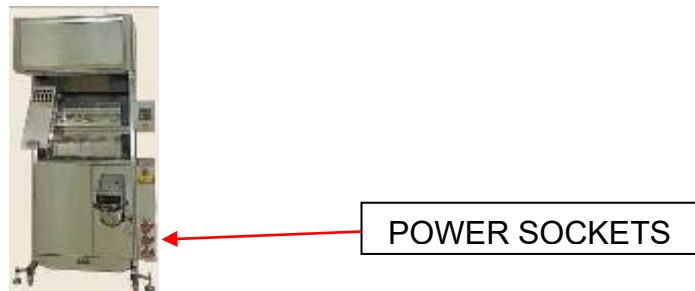

2. Check the machine after installation to ensure the conveyor belt runs in the right direction (see direction of arrow below). This should be done by “inching” the motor.  
If the motor rotation is incorrect transpose any two wires of the three phase carrying wires.



3. Ensure the machine is standing on a solid level floor.

**Note**

The Metro will only work if connected to a breadplant or a safety hopper is fitted.



# 6.0 ISOLATION

---

In an emergency, switch off the machine at the prover isolator or at the emergency stop button shown below.

EMERGENCY STOP BUTTON



To release stop button after use, twist and release.

## 7.0 CLEANING

---



### NOTE:

SWITCH OFF AND ISOLATE FROM THE MAINS SUPPLY BEFORE COMMENCING ANY CLEANING.

### DAILY CLEANING (DO NOT USE A PRESSURE WASHER)

1. Pull machine away from the prover.
2. Scrape off any dough residue.

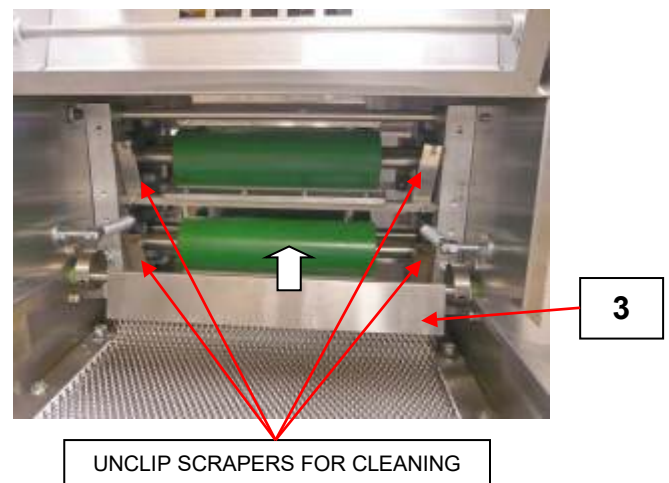

5. Raise front-hinged cover (2).
6. Lift out curling chain (3) and shake off any dough residue, then brush with a stiff nylon brush. **DO NOT WASH.**
7. Replace chain.
8. Unclip and wipe clean the scrapers (see photo above). **DO NOT WASH.** Smear edges with vegetable oil.
9. Scrape rollers with a **plastic** scraper and remove any debris from the roller edges.
10. Replace scrapers and close front cover.

11. Unclip and lower the rear window (5)



12. Unclip and wipe the rear scrapers  
**DO NOT WASH.**  
Smear edges with vegetable oil.
13. Scrape rollers with a **plastic** scraper and remove any debris from the roller edges.
14. Replace scrapers. Raise rear window. Wipe over Perspex window, with soft cloth dampened in a sterilising solution and hot water.
15. Open dough guides to maximum width by turning wheel (6).  
Push pressure board (7) towards the main body, then withdraw.

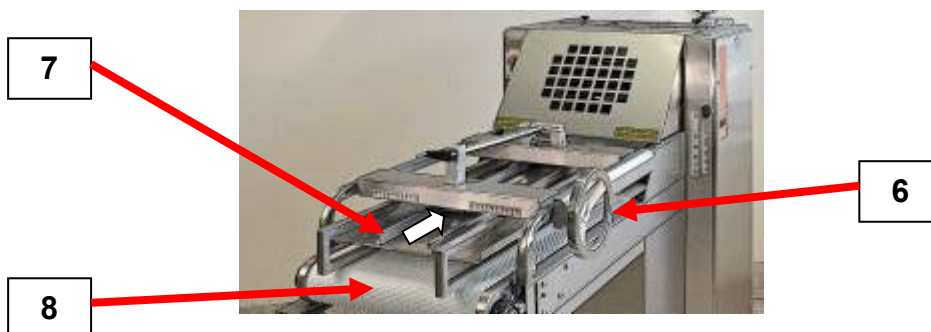

16. Wash board in sterilising solution and hot water, then dry and replace.
17. Scrape dough belt (8) with a **plastic scraper**.

**DO NOT USE A METAL SCRAPER OR ATTEMPT TO CLEAN WITH WATER. BELT WILL NEED TO BE INCHED FORWARD TO GAIN ACCESS TO ALL PARTS OF SURFACE. SEE SAFETY INSTRUCTIONS.**

18. Brush down external surface of machine to loosen any dough remaining.

19. Spot clean with cloth and sterilising solution in hot water, paying particular attention to handles, levers and controls.

## **WEEKLY CLEANING**



**NOTE:- SWITCH OFF AND ISOLATE FROM THE MAINS SUPPLY BEFORE COMMENCING ANY CLEANING.**

1. Follow the daily cleaning instructions 1 - 14 in previous section.
2. Remove side and back panels placing screws in a safe place.
3. Brush down framework where accessible to remove excess flour and dough.
4. Wipe down with a damp cloth and sterilising fluid and hot water.
5. Replace panels ensuring all screws are accounted for.
6. Follow the daily cleaning instructions 15 - 19 in previous section.
7. Scrape and scrub wheels clean as needed.

# 8.0 OPERATING INSTRUCTIONS

## HOW THE METRO MOULDS DOUGH PIECES

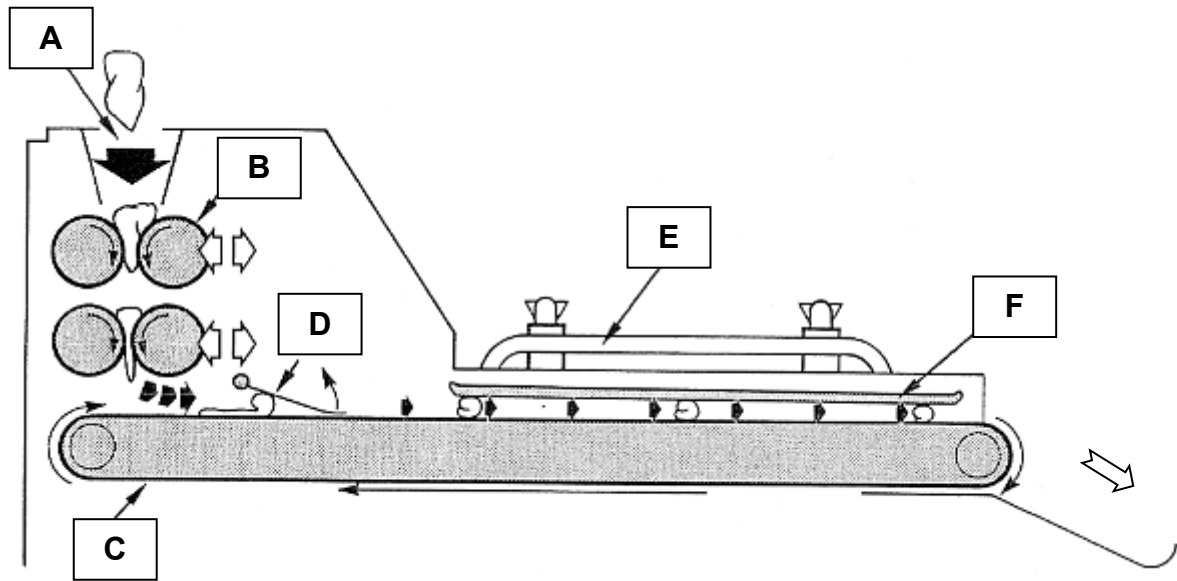

- Dough piece is fed in to hopper (A) from intermediate prover or safety hopper.
- Twin sets of rollers (B) form a sheet of dough.
- This is carried along the off take conveyor (C) to the curling chain (D).
- The curling chain then picks up the leading edge of the dough sheet and forms a curled roll of dough.
- This is then carried to the pressure module (E) in which it is moulded. Its final shape and consistency are determined by the pressure board (F) and the side guides (G) positions.
- The finished dough pieces are conveyed to the collection tray.

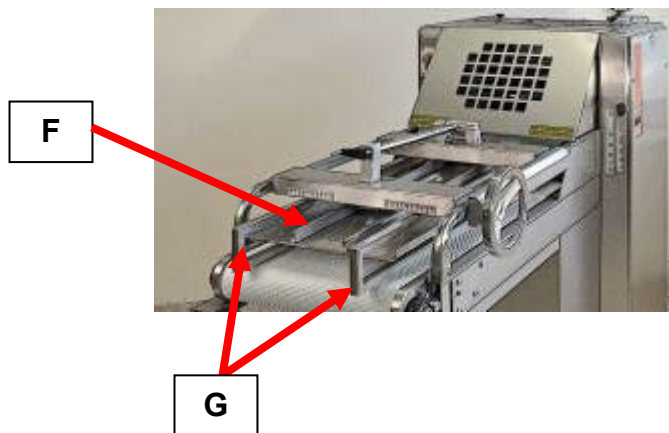

# OPERATING THE METRO MOULDER

To ensure the best mould, make sure that the moulder is free of any previous dough used and set the following adjustments.

- a. Hopper width. (move cheeks(15) to required width).
- b. Sheeting gap. (move lever (16))
- c. Side guides position.(turn wheel (6) to adjust pressure board width)
- d. Moulding pressure.(turn handle (17) to adjust pressure board height)

| MOULDER ADJUSTMENTS CHART |                      |                           |                      |                               |
|---------------------------|----------------------|---------------------------|----------------------|-------------------------------|
| DOUGH PIECE WEIGHT        | HOPPER CHEEK SETTING | SHEETING ROLL GAP SETTING | PRESSURE BOARD WIDTH | PRESSURE BOARD HEIGHT SETTING |
| 900g                      | 1                    | 4                         | 10                   | 10                            |
| 450g                      | 5                    | 6                         | 8                    | 6                             |
| 225g                      | 6                    | 6                         | 10.5                 | 6                             |

---

## a. HOPPER WIDTH ADJUSTMENT.

1. Slacken wing bolts (14) and slid the hopper cheeks (15) to the required setting. *See chart above for suggested settings.*
2. Hand-tighten wing bolts and go on to next adjustment.

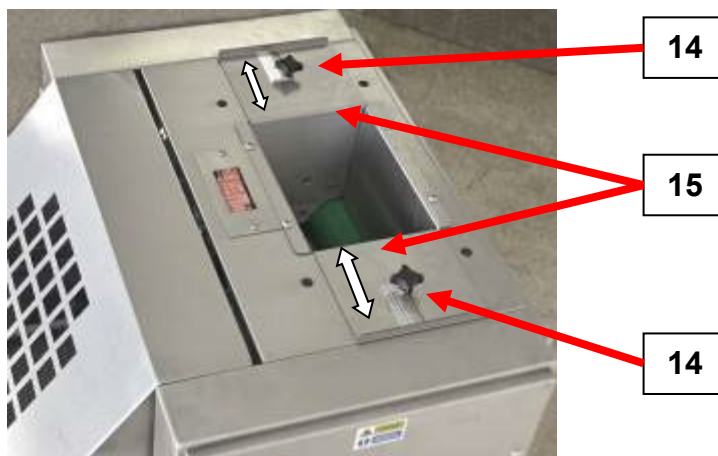

**b. SHEETING GAP ADJUSTMENT.**

1. Move roller gap lever (16) to required setting.  
*See chart for suggested settings.*



**c. SIDE GUIDES ADJUSTMENT.**

1. Turn wheel (6) to required setting.  
*See chart for suggested settings.*

---

**d. MOULDING PRESSURE ADJUSTMENT.**

1. The pressure board height is adjusted by turning the adjusting handle (17).

*To ensure the moulding pressure can be exactly reproduced at a later date, the adjusting handle shaft is graduated (18).*



## STARTING THE METRO

- Before starting ensure the metro has been adjusted for the product mould required. (See previous section.)
- If using in conjunction with a prover, make sure that the Metro is in the correct position with the hopper.
- Do not allow dough pieces to “skin” as this will result in the dough pieces catching each other up, “doubling”, and could cause a jam.

**To start the machine press the green button** found on the main body next to the stop switch.

START BUTTON



If used with a prover always start the moulder before the prover or a build up of dough could clog the moulder hopper



## 9.0 TROUBLESHOOTING

---

### MOULDER WILL NOT START

- Is power supply switched on?
  - Is stop button released?  
(twist to release)
  - Are all covers and doors closed?
  - When used with a prover, is machine in the correct position under the conveyor?
- 

### DOUGH PIECES DOUBLE UP

- Dough has been allowed to “skin” (left too long proving).
  - Hopper setting incorrect. (Increase gap)
- 

### DOUGH PIECES TEARING

- Pressure board (7) too low.
- Sheeting gap too small

## 10.0 SERVICE AND SPARES ---

If a fault arises, please do not hesitate to contact the Customer Service Department, quoting the **machine serial number** on the silver information plate of the machine and on the front cover of this manual

### **MONO**

**Queensway  
Swansea West Industrial Estate  
Swansea.  
SA5 4EB  
UK**

**email: [spares@monoequip.com](mailto:spares@monoequip.com)  
Spares Tel. +44(0)1792 564039**

**Web site: [www.monoequip.com](http://www.monoequip.com)**

**Main Tel. 01792 561234  
Fax. +44(0)1792 561016**



# 11.0 ELECTRICAL INFORMATION —



IF IN ANY DOUBT - ASK

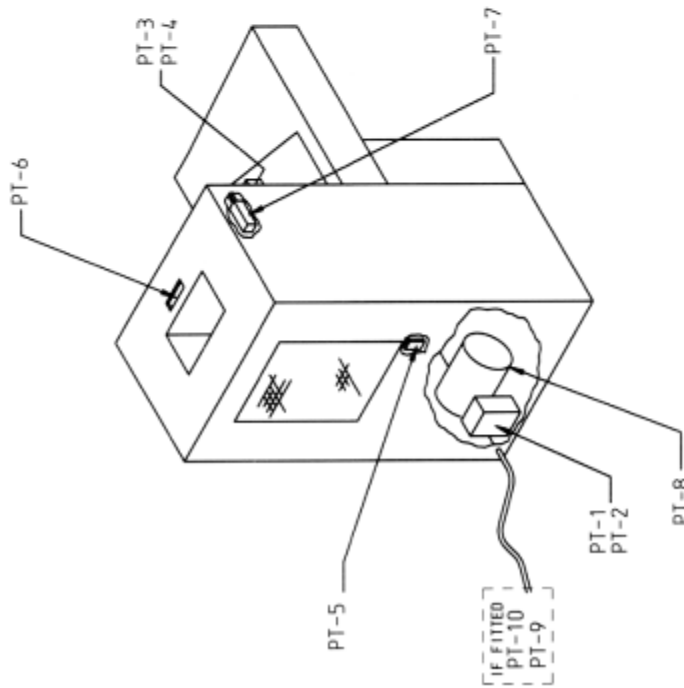

**DRAWING**  
PT-Ref

**DESCRIPTION**

**MONO**

**PART NUMBER**

|       |                                    |             |
|-------|------------------------------------|-------------|
| PT-1  | MAIN MOTOR CONTACTOR               | 8824-08-002 |
| PT-2  | MAIN MOTOR THERMAL OVERLOAD        | 8824-01-003 |
| PT-1  | MAIN MOTOR CONTACTOR               | 8809-03-005 |
| PT-2  | MAIN MOTOR THERMAL OVERLOAD        | 8809-01-004 |
| PT-3a | REMOTE STOP BUTTON                 | 8801-12-015 |
| PT-3b | REMOTE STOP BUTTON CONTACT BLOCK   | 8801-14-001 |
| PT-3c | *STOP* LEGEND                      | 8801-15-003 |
| PT-4a | REMOTE START BUTTON                | 8801-12-002 |
| PT-4b | REMOTE START BUTTON CONTACT BUTTON | 8801-14-002 |
| PT-4c | *START LEGEND                      | 8801-15-002 |
| PT-5  | REAR ACCESS COVER SAFETY SWITCH    | 8801-11-009 |
| PT-6  | HOPPER SAFETY SWITCH               | 8818-07-008 |
| PT-7  | FRONT COVER SAFETY SWITCH          | 8801-11-008 |
| PT-8  | MAIN MOTOR                         | 8809-74-018 |
| PT-9  | MAINS PLUG (IF FITTED)             | 8814-25-001 |
| PT-10 | MAINS PLUG FUSE (IF FITTED)        | 8883-85-001 |

|   |     |          |                                       |         |
|---|-----|----------|---------------------------------------|---------|
| F   | JC  | 19-06-08 | PT1 WAS 8809-03-004                   | 091/08  |
| E   | JC  | 30-07-07 | PT1 & PT2 WERE 8775 (MTE)             | 3033    |
| D   | RAC | 3-2-04   | PARTS 1 AND 2 CHANGED                 | 2138    |
| C   | JC  | 11-1-99  | PARTS LIST REVISED                    | 08/55   |
| B   | SP  | 13-3-96  | NEW MTE STARTER. (PARTS LIST REVISED) | 6097    |
| A   | SP  | 12-1-95  | PICTORIAL CORRECTIONS                 |         |
| REV   | NO  | DATE     | REVISION                              | ECH NO. |
| <p><b>MONO EQUIPMENT</b><br/>                 CLYDEBANK<br/>                 BRANNAHA WEST IND PARK<br/>                 BRANNAHA<br/>                 SAS AEB.<br/>                 TEL: (01782) 861284<br/>                 FAC: (01782) 861618</p> |     |          |                                       |         |
| <p><b>TITLE:</b><br/>                 METRO MOULDER<br/>                 COMPONENTS LAYOUT</p>  |     |          |                                       |         |
| <p><b>ELECTRICAL SPECIFICATIONS:-</b><br/>                 415V 3PH N 50HZ</p>  |     |          |                                       |         |
| <p><b>DRAWING:</b><br/>                 SP/JC</p>   |     |          |                                       |         |
| <p><b>DATE:</b><br/>                 24-5-96</p>  |     |          |                                       |         |
| <p><b>DRAWING NO.:</b><br/>                 M021E25-00500</p>   |     |          |                                       |         |
| <p><b>REVISION APPROVED BY:-</b></p>  |     |          |                                       |         |
| <p><b>REVISION</b></p>  |     |          |                                       |         |

REDRAWN ON CAD 18-98  
 COPYRIGHT © 1998 - THIS DESIGN/DRAWING IS THE PROPERTY OF MONO EQUIPMENT LTD. AND MUST NOT BE REPRODUCED, COPIED,  
 NOR ITS CONTENTS DIVULGED WITHOUT PRIOR WRITTEN PERMISSION.

IF IN ANY DOUBT - ASK

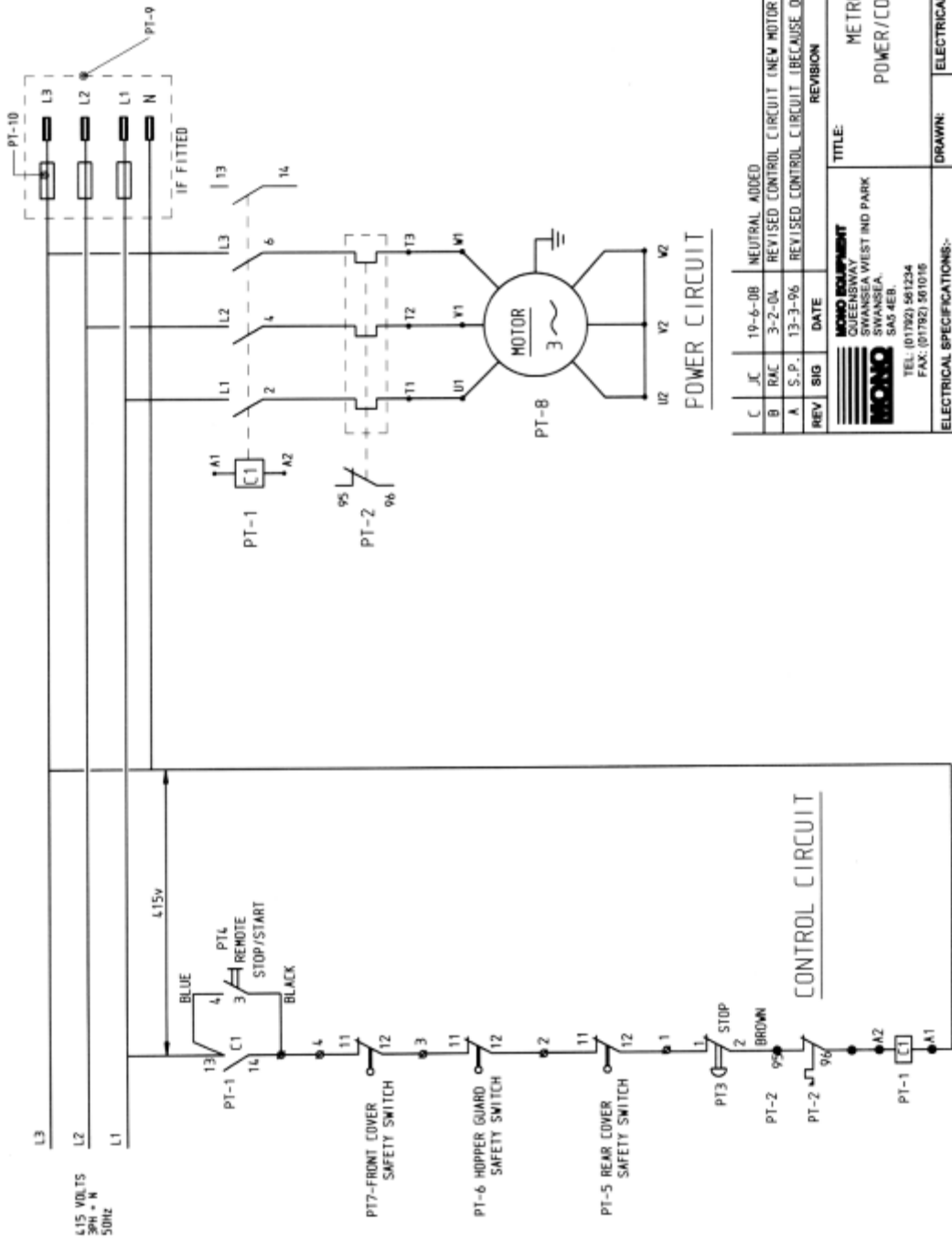

| REV | SIG  | DATE    | REVISION   | ECON NO. |
|-----|------|---------|--|----------|
| C   | JC   | 19-6-08 | NEUTRAL ADDED  | 091/08   |
| B   | RAC  | 3-2-04  | REVISED CONTROL CIRCUIT (NEW MOTOR CONTACTOR)        | 2138     |
| A   | S.P. | 13-3-96 | REVISED CONTROL CIRCUIT (BECAUSE OF NEW MTE STARTER) | 6097     |

|  |  |  |  |
|--|--|--|--|
| <b>MONO EQUIPMENT</b><br>QUEENSWAY<br>SWANSEA WEST IND PARK<br>SWANSEA,<br>SA5 4EB.<br>TEL: (01792) 561234<br>FAX: (01792) 501016  |  | TITLE:<br>METRO MOULDER<br>POWER/CONTROL DIAGRAM |  |
| ELECTRICAL SPECIFICATIONS:-<br>4.15V 3PH N 50HZ  |  | DRAWN:<br>S.P.                                   | ELECTRICALLY APPROVED BY:-                       |
| COPYRIGHT © 1998 - THIS DESIGN/DRAWING IS THE PROPERTY OF MONO EQUIPMENT LTD. AND MUST NOT BE REPRODUCED, COPIED, OR ITS CONTENTS DIVULGED WITHOUT PRIOR WRITTEN PERMISSION. |  | DATE:<br>12-1-95                                 | DRAWING NO. SHEET 2 OF 2<br>M021E25-00500 REV: C |

# 12.0 MAINTENANCE

---



**WARNING**

- This appliance must be maintained at regular intervals. The frequency of maintenance will depend upon your specific use and location. The maximum service interval should be 12 months.
- Service and maintenance should only be undertaken by suitably qualified, trained, and competent engineers.
- You must immediately report any damage or defect arising with the appliance.
- Unsafe equipment is dangerous. Do not use the appliance. Isolate the power supply and contact MONO or your appointed service agent.



**WARNING**

- Isolate the machine from the mains supply before attempting any maintenance operations.
-



Queensway  
Swansea West Industrial Estate  
Swansea.  
SA5 4EB  
UK

[email:spares@monoequip.com](mailto:spares@monoequip.com)  
[Web site:www.monoequip.com](http://www.monoequip.com)

**Tel. 01792 561234**  
**Fax. 01792 561016**

FOR SERVICE AND SPARES RING: **01792 564044**

**DISPOSAL**

**CARE SHOULD BE TAKEN WHEN THE MACHINE COMES TO THE END OF ITS WORKING LIFE.  
ALL PARTS SHOULD BE DISPOSED OF IN THE APPROPRIATE PLACE, EITHER BY RECYCLING  
OR OTHER MEANS OF DISPOSAL THAT COMPLIES WITH LOCAL REGULATIONS.  
(IN UK, ENVIRONMENTAL PROTECTION ACT 1990 APPLIES)**

**DISPOSE OF UNUSED PRODUCT AND CONTAINERS  
CAREFULLY AND RESPONSIBLY**