

[www.monoequip.com](http://www.monoequip.com)



# Omega

## DOUGH DEPOSITOR

### **SPARES MANUAL**

### MACHINE NO.FG079

When ordering spares please quote the **machine serial number** which can be found on the silver information plate of the machine and on the front cover of your manual.

**MONO EQUIPMENT**  
Queensway  
Swansea West Industrial Estate  
Swansea. SA5 4EB UK

Tel. +44(0)1792 561234  
email:spares@monoequip.com  
Spares Tel. +44(0)1792 564039  
Fax. 01792 561016



## **SAFETY SYMBOLS**

The following safety symbols are used throughout available product documentation and the operating manual (available at [www.monoequip.com](http://www.monoequip.com)).

Pay special attention to information marked with the following symbols.



### **WARNING**

Indicates a hazardous situation which, if not avoided, will result in death or serious injury.



### **WARNING**

Indicates a hazardous situation which, if not avoided, will result in electric shock.



### **CAUTION**

Indicates a hazardous situation which, if not avoided, will result in minor or moderate injury.

## **ELECTRICAL SAFETY AND ADVICE REGARDING SUPPLEMENTARY ELECTRICAL PROTECTION:**

Commercial bakeries, kitchens and foodservice areas are environments where electrical appliances may be located close to liquids or operate in and around damp conditions or where restricted movement for installation and service is evident.

The installation and periodic inspection of the appliance should only be undertaken by a qualified, skilled and competent electrician, and connected to the correct power supply suitable for the load as stipulated by the appliance data label.

The electrical installation and connections should meet the necessary requirements of the local electrical wiring regulations and any electrical safety guidelines.

### **No work should be undertaken without disconnecting the power.**

### **We Recommend:**

- Supplementary electrical protection with the use of a residual current device (RCD)
- Fixed wiring appliances incorporate a locally situated switch disconnecter to connect to, which is easily accessible for switching off and safe isolation purposes. The switch disconnecter must meet the specification requirements of IEC 60947.



The supply to this machine must be protected by a **30mA RCD**

## Omega TOUCH

---

PAGE 5	BASE MACHINE COMPONENTS
PAGE 6	ELECTRICAL COMPONENTS
PAGE 7	MECHANICAL COMPONENTS



## Omega PLUS INCLUDING WIRECUT

---

PAGE 9	BASE MACHINE COMPONENTS
PAGE 10	ELECTRICAL COMPONENTS
PAGE 11	MECHANICAL COMPONENTS



## Omega PLUS

---

PAGE 13	BASE MACHINE COMPONENTS
PAGE 14	ELECTRICAL COMPONENTS
PAGE 15	MECHANICAL COMPONENTS



PAGE 17 HOPPER – SOFT DOUGH

PAGE 18 HOPPER – HARD DOUGH (OMEGA PLUS ONLY)

---

PAGE 19	<b><u>OMEGA TLCC/LMC TO M251 CONVERSION KITS</u></b> (Converts older machines to latest specification controller and screen)
	<b><u>M079-KSE009 OMEGA DEPOSITOR TLCC TO M251 CONVERSION KIT</u></b>
	<b><u>M079-KSE007 OMEGA DEPOSITOR LMC (GT) TO M251 CONVERSION KIT</u></b>
	<b><u>M079-KSE008 OMEGA DEPOSITOR LMC (GTO) TO M251 CONVERSION KIT</u></b>

PAGE 20 TLCC to M251 Conversion Procedure

PAGE 31 LMC20 to M251 Conversion Procedure



# — Omega TOUCH —



**BASE MACHINE SPARES LIST**

Omega TOUCH

Spares Item Description	Mono Part No.	Qty Req. per M/C
Deposit Gearbox	A900-11-095	1
Jog Gearbox	A900-11-092	1
Rotary Gearbox	A900-11-091	1
Tray Gearbox	A900-11-091	1
Concentric Guide Roller	A900-06-274	2
Eccentric Guide Roller	A900-06-273	2
Slide Plate	078-03-00016	2
Jog Drive Chain	A900-08-066	1
Simplex Sprocket 16T 1/2" Pitch	A900-07-071	1
Idler Sprocket 16T 1/2" Pitch	A900-07-072	1
Circlip-Ext Metric 14mm Dia	A900-01-280	1
Circlip-Ext Metric 24mm Dia	A900-01-193	1
Drive Shaft – Hopper	078-03-00015	1
Rotary Drive Shaft	078-03-00011	1
Drive Gear - Rotary Template	078-03-00010	1
Lip Seal (Rotary Drive Shaft)	A900-12-075	1
Lip Seal (Deposit Drive Shaft)	A900-12-079	1
End Guard (Earlier plastic version)	078-11-00036 078-11-00005)	1
Retainer – End Guard (Earlier plastic version)	078-11-00035 078-11-00002)	2
Spacer – 450mm/580mm Hopper	078-11-00003	1
Spacer – 400mm Hopper	078-11-00004	1
Seal-Rear Cover	A900-25-309	1

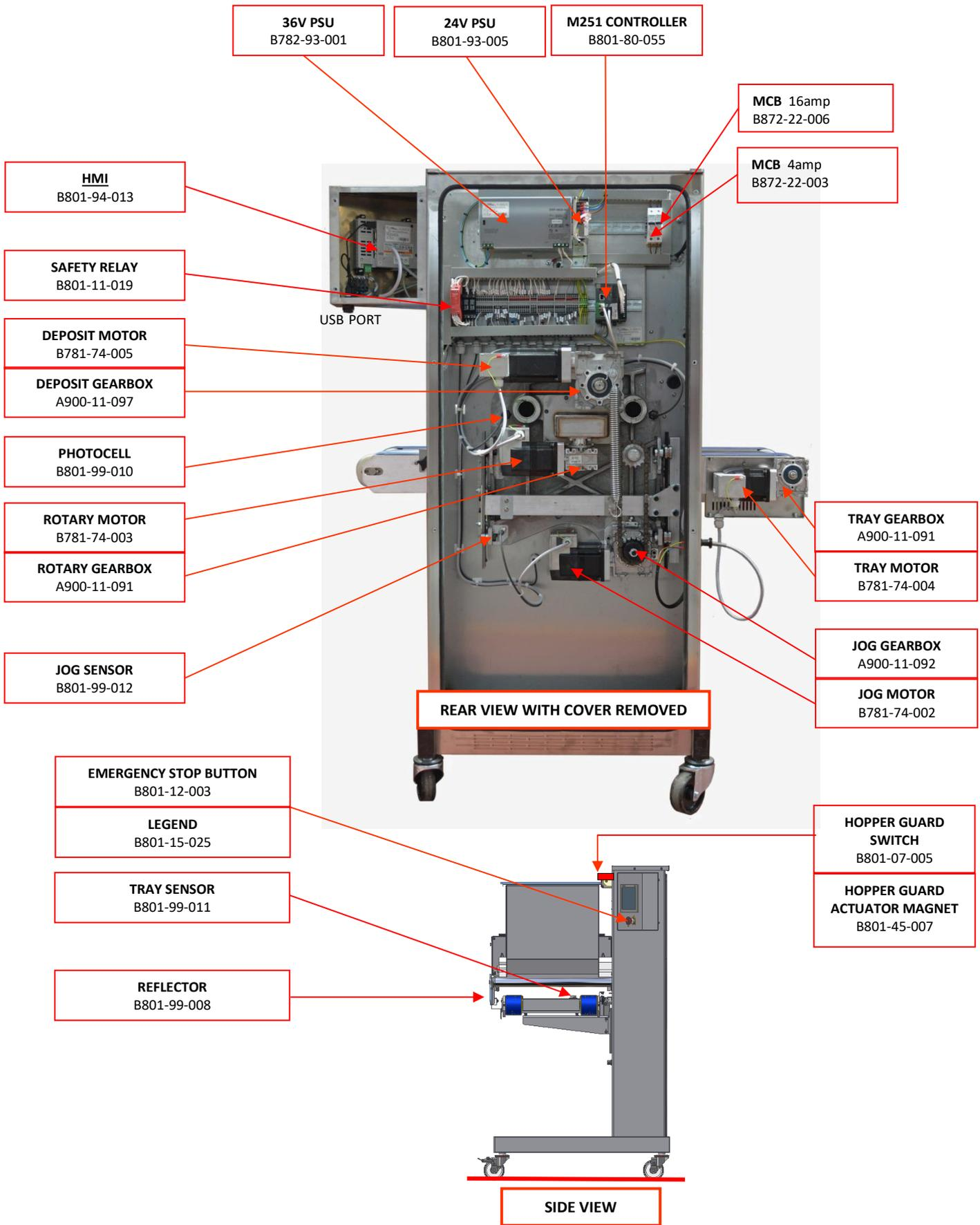

**REAR VIEW WITH COVER REMOVED**

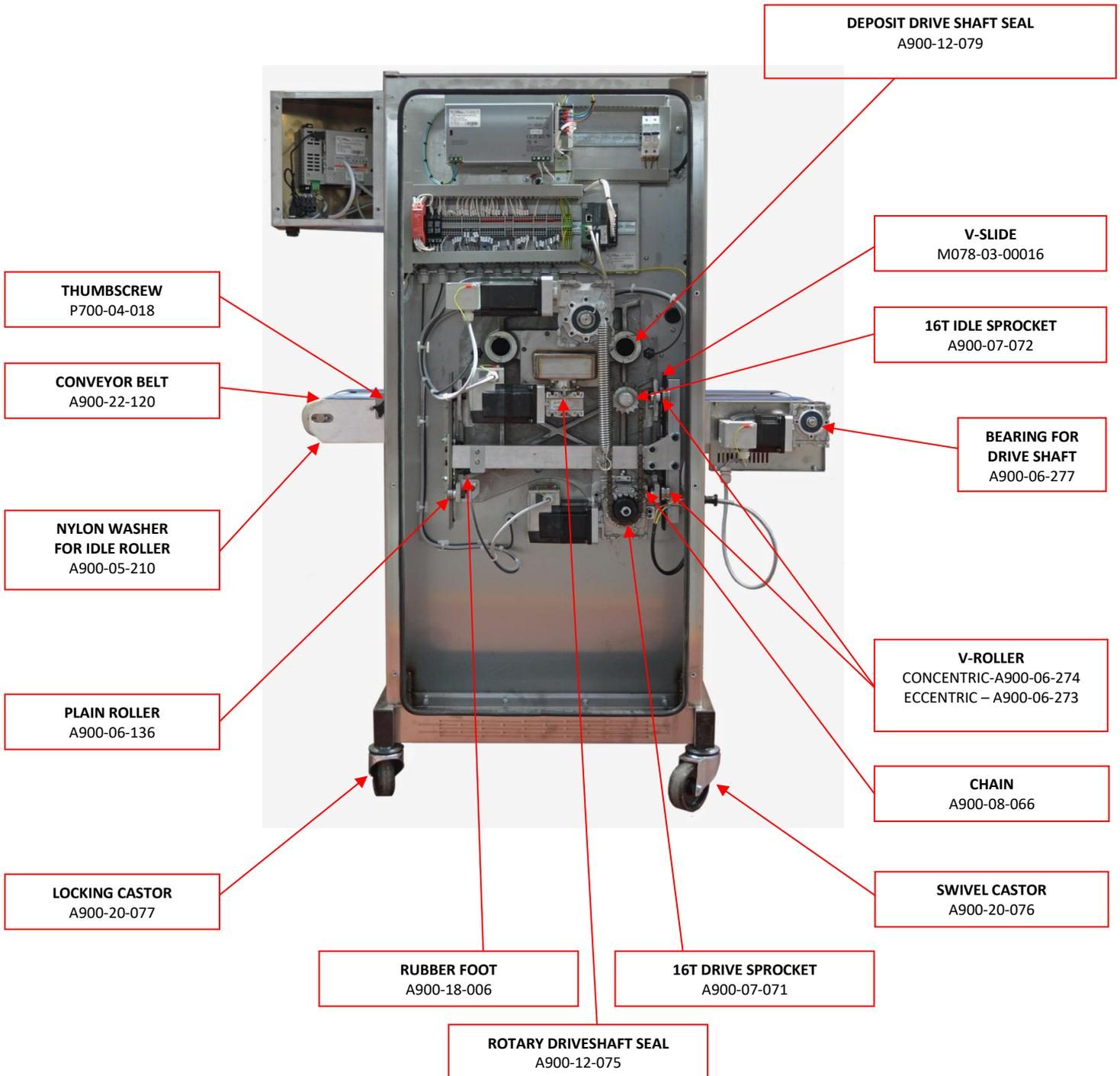



# — Omega PLUS — WITH WIRECUT



**BASE MACHINE SPARES LIST**

Omega PLUS -- WIRECUT VERSION

<b>Spares Item Description</b>	<b>Mono Part No.</b>	<b>Qty Req. per M/C</b>
Deposit Gearbox	A900-11-097	1
Jog Gearbox	A900-11-092	1
Rotary Gearbox	A900-11-091	1
Tray Gearbox	A900-11-091	1
Concentric Guide Roller	A900-06-274	2
Eccentric Guide Roller	A900-06-273	2
V Slide	078-03-00016	1
Slide Plate	078-03-00027	1
Jog Drive Chain	A900-08-066	1
Simplex Sprocket 16T 1/2" Pitch	A900-07-071	1
Idler Sprocket 16T 1/2" Pitch	A900-07-072	1
Circlip-Ext Metric 14mm Dia	A900-01-280	1
Circlip-Ext Metric 24mm Dia	A900-01-193	1
Drive Shaft – Hopper	078-03-00015	1
Rotary Drive Shaft	078-03-00011	1
Drive Gear - Rotary Template	078-03-00010	1
Lip Seal (Rotary Drive Shaft)	A900-12-075	1
Lip Seal (Deposit Drive Shaft)	A900-12-079	1
End Guard (Earlier plastic version)	078-11-00036 078-11-00005)	1
Retainer – End Guard (Earlier plastic version)	078-11-00035 078-11-00002)	2
Spacer – 450mm/580mm Hopper	078-11-00003	1
Spacer – 400mm Hopper	078-11-00004	1
Seal-Rear Cover	A900-25-309	1



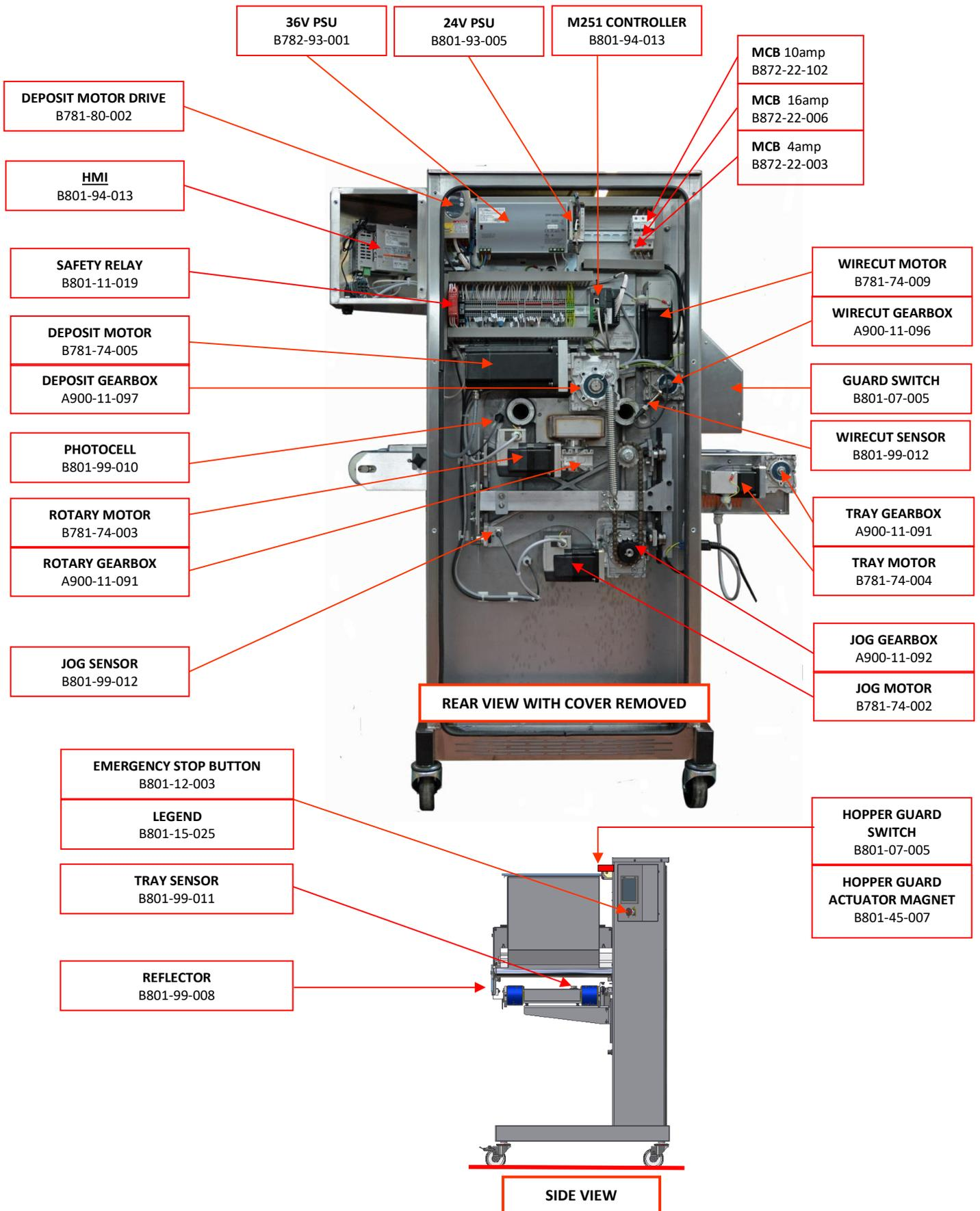

**REAR VIEW WITH COVER REMOVED**

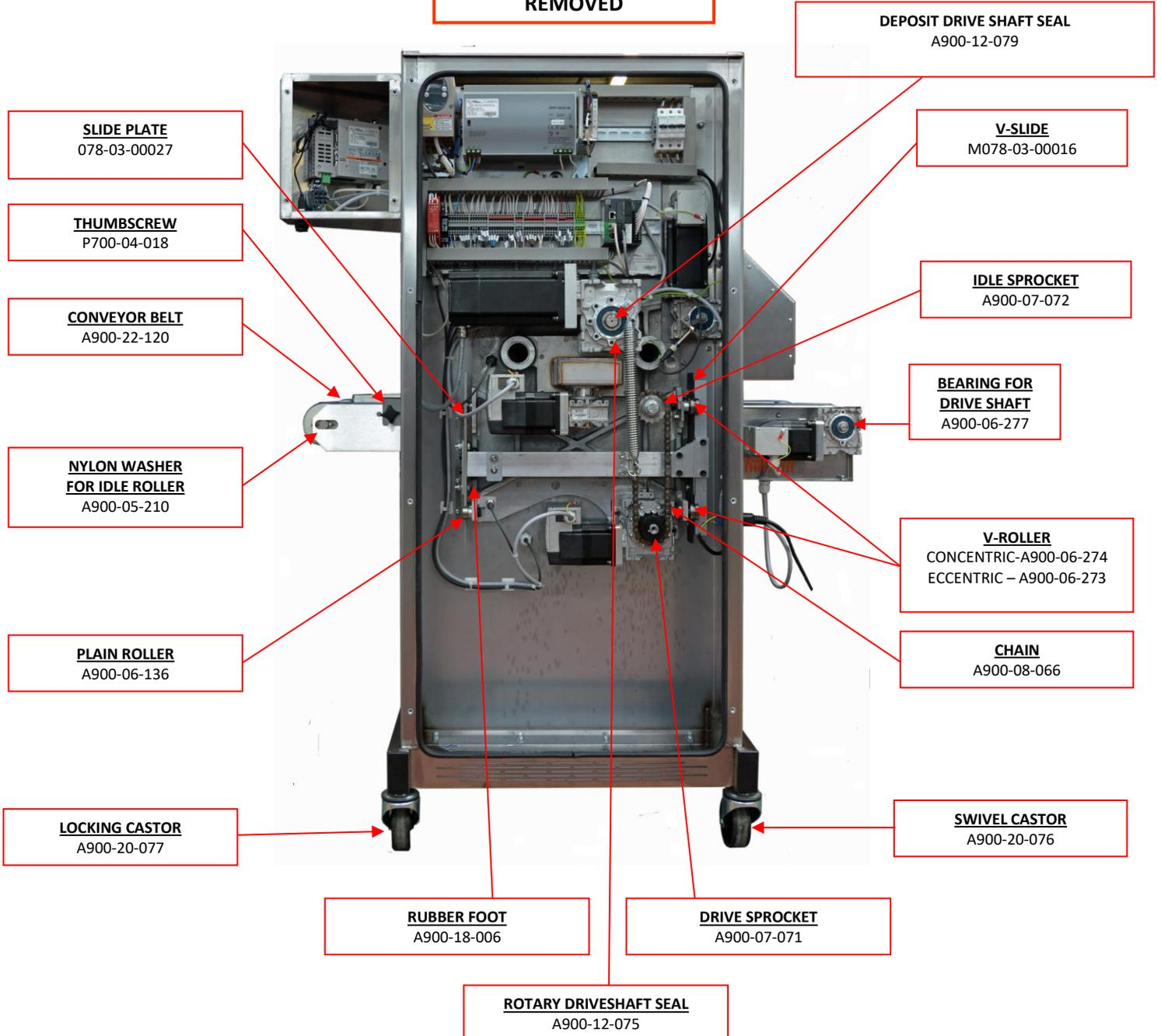

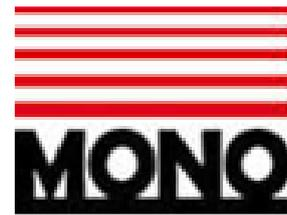

# — Omega PLUS. — NO WIRECUT



**BASE MACHINE SPARES LIST**Omega PLUS -- NO WIRECUT VERSION

<b>Spares Item Description</b>	<b>Mono Part No.</b>	<b>Qty Req. per Machine</b>
Deposit Gearbox	A900-11-097	1
Jog Gearbox	A900-11-092	1
Rotary Gearbox	A900-11-091	1
Tray Gearbox	A900-11-091	1
Concentric Guide Roller	A900-06-274	2
Eccentric Guide Roller	A900-06-273	2
V Slide	078-03-00016	1
Slide Plate	078-03-00027	1
Jog Drive Chain	A900-08-066	1
Simplex Sprocket 16T 1/2" Pitch	A900-07-071	1
Idler Sprocket 16T 1/2" Pitch	A900-07-072	1
Circlip-Ext Metric 14mm Dia	A900-01-280	1
Circlip-Ext Metric 24mm Dia	A900-01-193	1
Drive Shaft – Hopper	078-03-00015	1
Rotary Drive Shaft	078-03-00011	1
Drive Gear - Rotary Template	078-03-00010	1
Lip Seal (Rotary Drive Shaft)	A900-12-075	1
Lip Seal (Deposit Drive Shaft)	A900-12-079	1
End Guard (Earlier plastic version)	078-11-00036 078-11-00005)	1
Retainer – End Guard (Earlier plastic version)	078-11-00035 078-11-00002)	2
Spacer – 450mm/580mm Hopper	078-11-00003	1
Spacer – 400mm Hopper	078-11-00004	1
Seal-Rear Cover	A900-25-309	1



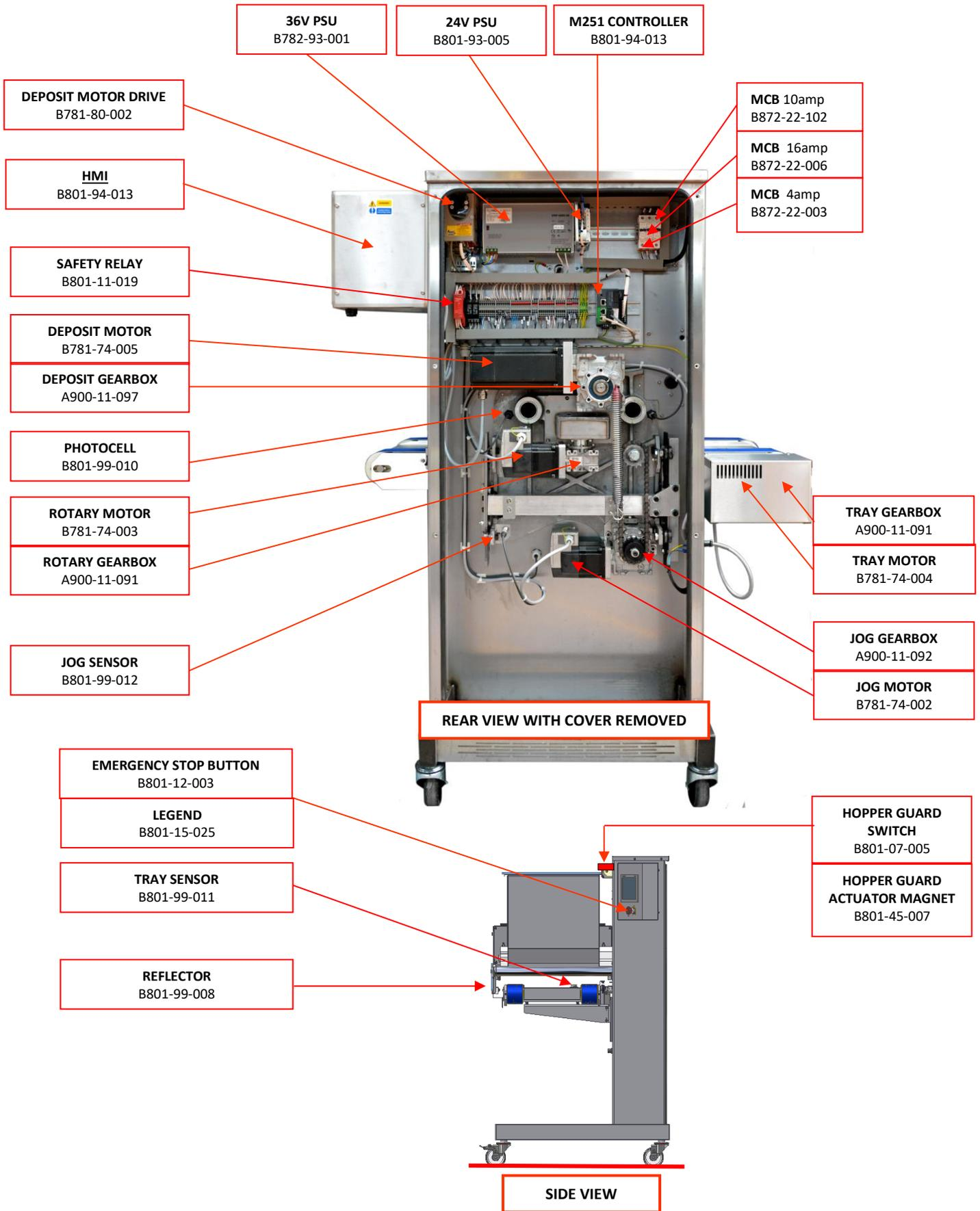

**REAR VIEW WITH COVER REMOVED**

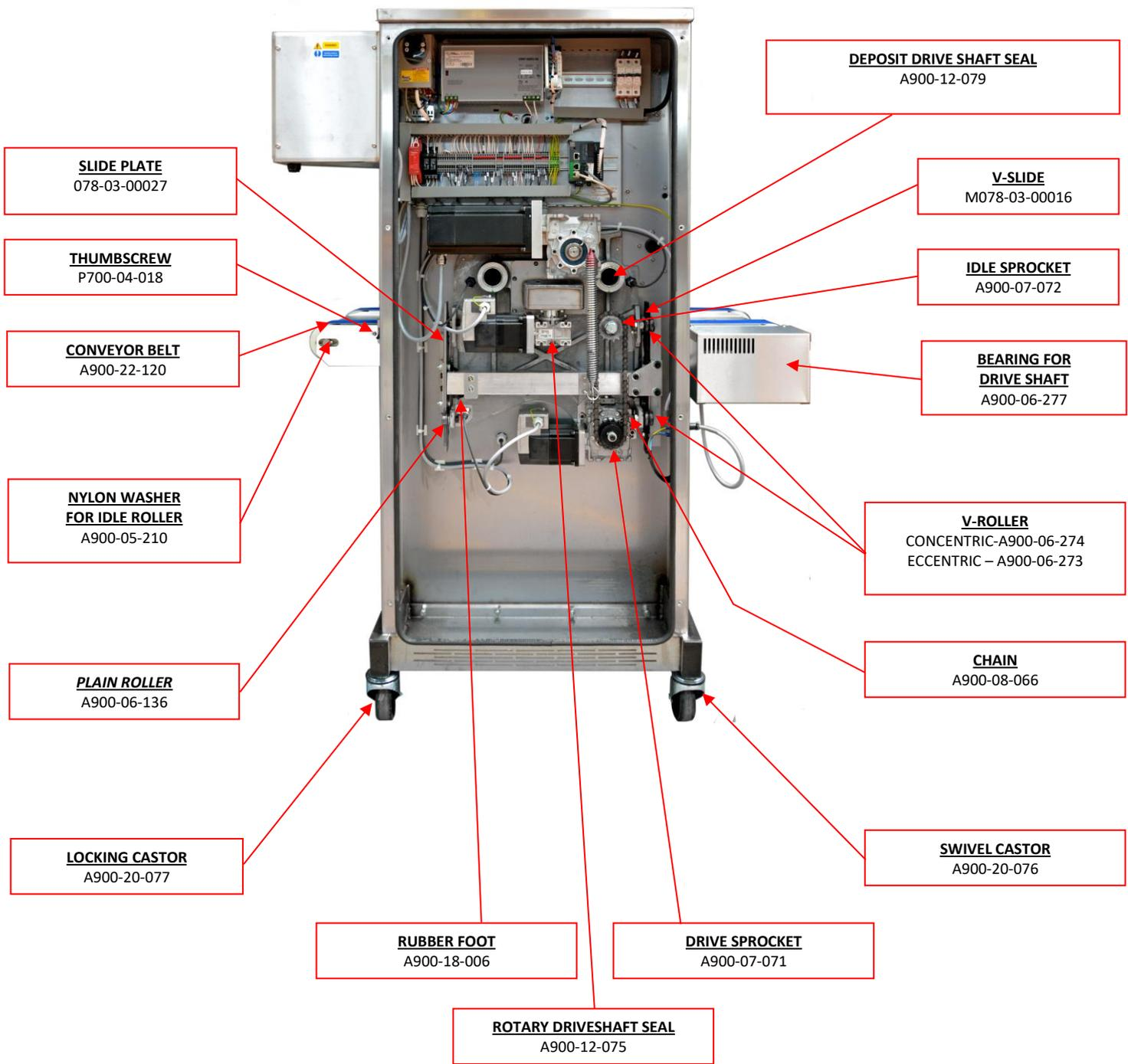

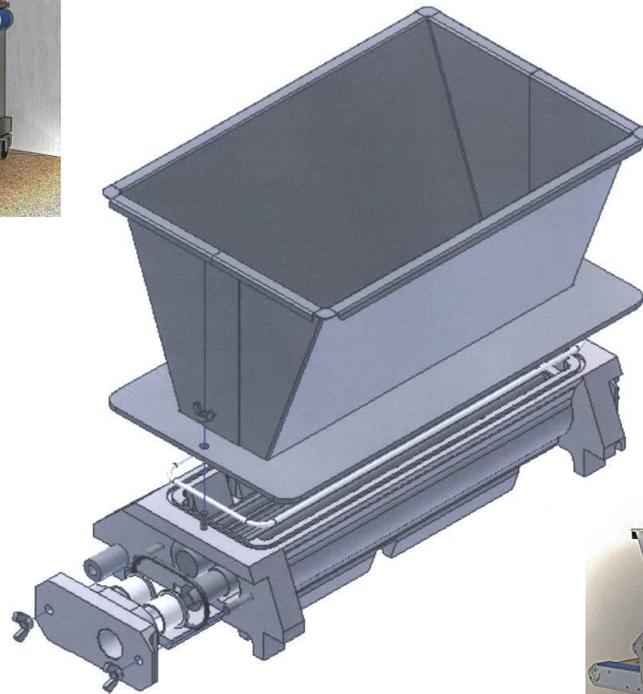

# — Omega — HOPPER PARTS



### HOPPER FABRICATION

#### STANDARD CAPACITY

M078-09-00008 (400mm)  
 M078-09-00001 (450mm)  
 M078-09-00046 (580mm)

#### EXTENDED CAPACITY

M073-09-00200 (400mm)  
 M073-09-00202 (450mm)  
 M073-09-00203 (580mm)

**END CAP (NON-DRIVE SIDE)**  
 M073-09-03200

**END CAP ASSEMBLY (NON-DRIVE SIDE)**  
**M073-KMX002**  
 (END CAP AND BUSHES FITTED)

**END CAP BUSH**  
 M073-09-00600

**WINGNUT**  
 A900-04-043

#### HOPPER SEAL

A900-12-083 (400mm)  
 A900-12-084 (450mm)  
 A900-12-085 (580mm)

#### DRIVEN GEAR

M073-09-00702 (400mm)  
 M073-09-01602 (450mm)  
 M073-09-01702 (580mm)

**WINGNUT**  
 A900-04-147

**END CAP (DRIVE SIDE)**  
 M073-09-00500

**END CAP ASSEMBLY (DRIVE SIDE)**  
**M073-KMX001**  
 (END CAP AND BUSHES FITTED)

**END CAP BUSH**  
 M073-09-00600

#### DRIVE GEAR

M073-09-00700 (400mm)  
 M073-09-01600 (450mm)  
 M073-09-01700 (580mm)

**END CAP SEAL**  
 A900-12-074

#### TEMPLATES TO CUSTOMER REQUIREMENTS

- ROTARY
- STANDARD
- DIE
- STAGGERED
- SHEETING
  - NON-DRIP
  - MULTI SHEETING
- INJECTION

#### POUR-THROUGH TOP GUARD (NOT SHOWN)

STANDARD	400MM	078-11-00066
	450MM	078-11-00067
	580MM	078-11-00068
EXTENDED	400MM	078-11-00063
	450MM	078-11-00064
	580MM	078-11-00065

Actuator magnet on all guards B801-45-007

## HOPPER FABRICATION

### STANDARD CAPACITY

M078-09-00086 (400mm)  
 M078-09-00042 (450mm)  
 M078-09-00089 (580mm)

### EXTENDED CAPACITY

M078-09-00087 (400mm)  
 M078-09-00088 (450mm)

**WINGNUT**  
 A900-04-147

**UPPER END BLOCK (DRIVEN SIDE)**  
 M078-09-00144

## ROLLER OPTIONS

**M078-KMX004 400mm**  
 4MM GROOVE - ALUMINIUM

**M078-KMX005 400mm**  
 6MM GROOVE - ALUMINIUM

**M078-KMX006 400mm**  
 8MM GROOVE - ALUMINIUM

**M078-KMX015 400mm**  
 8MM GROOVE - PLASTIC

**M078-KMX007 450mm**  
 4MM GROOVE - ALUMINIUM

**M078-KMX008 450mm**  
 6MM GROOVE - ALUMINIUM

**M078-KMX009 450mm**  
 8MM GROOVE - ALUMINIUM

**M078-KMX010 580mm**  
 4MM GROOVE - ALUMINIUM

**M078-KMX011 580mm**  
 6MM GROOVE - ALUMINIUM

**M078-KMX012 580mm**  
 8MM GROOVE - ALUMINIUM

### STANDARD(St Steel) ROLLERS

DRIVE	400MM	078-09-00066
	450MM	078-09-00060
	580MM	078-09-00074
DRIVEN	400MM	078-09-00067
	450MM	078-09-00061
	580MM	078-09-00075

## TEMPLATES TO CUSTOMER REQUIREMENTS

### ROTARY

- SMALL BORE
- LARGE BORE

### STANDARD

- SMALL BORE
- LARGE BORE

### DIE

### SHEETING

## POUR-THROUGH TOP GUARD (NOT SHOWN)

HARD DOUGH	400MM	078-11-00060
	450MM	078-11-00061
	580MM	078-11-00062

Actuator magnet on all guards B801-45-007

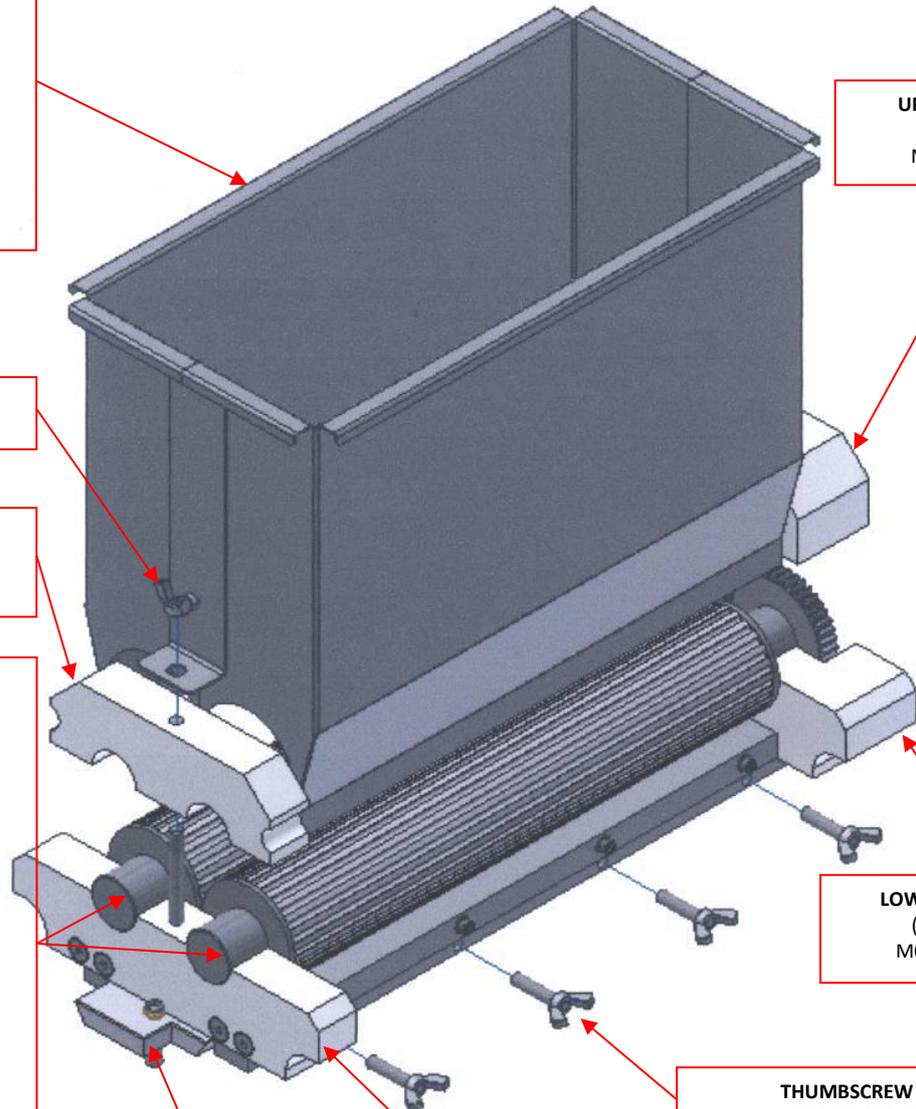

**UPPER END BLOCK (DRIVE SIDE)**  
 M078-09-00143

**LOWER END BLOCK (DRIVE SIDE)**  
 M078-09-00141

**THUMBSCREW**  
 M078-09-00043

**LOWER END BLOCK (DRIVEN SIDE)**  
 M078-09-00142



# **OMEGA TLCC/LMC TO M251 CONVERSION KITS**

**(Converts older machines to latest specification controller and screen)**

## **M079-KSE009 OMEGA DEPOSITOR TLCC TO M251 CONVERSION KIT**

Comprises of :

078-25-00051 CONVERSION BRACKET & FIXINGS (manufactured)

M079-KSE006 TLCC TO M251 CONVERSION (HAC Ref: H300-001-0063)

H200-004-038 Omega depositor MK3 M251 controller

H200-005-011 Omega depositor MK3 HMI

H200-007-010 Ethernet cat 6 patch cable 1.5m

H200-100-060 Omega TLCC to M251 IO and power loom

H200-007-011 Omega TLCC to M251 canopen comms cable.

H100-007-012 TM3 expansion module 8 input 24V DC

H200-003-073 USB stick blank FAT32

TS35 DIN Rail for mounting M251 (TLCC 90mm)

Also to include instructions - M251 Conversion procedure (TLCC)

## **M079-KSE007 OMEGA DEPOSITOR LMC (GT) TO M251 CONVERSION KIT**

HAC Ref: H300-001-0064

Comprises of :

H200-004-038 Omega depositor MK3 M251 controller

H200-005-011 Omega depositor MK3 HMI

H200-007-010 Ethernet cat 6 patch cable 1.5m

H200-100-061 Omega LMC to M251 IO and power loom

H200-007-012 Omega LMC to M251 canopen comms cable.

H100-007-012 TM3 expansion module 8 input 24V DC

H200-003-073 USB stick blank FAT32

TS35 DIN Rail for mounting M251 (LMC 410mm)

Also to include instructions - M251 Conversion procedure (LMC)

## **M079-KSE008 OMEGA DEPOSITOR LMC (GTO) TO M251 CONVERSION KIT**

HAC Ref: H300-001-0065

Comprises of :

H200-004-038 Omega depositor MK3 M251 controller

H200-003-064 Omega depositor MK3 HMI USB stick 4.3.0.0.A

H200-007-010 Ethernet cat 6 patch cable 1.5m

H200-100-061 Omega LMC to M251 IO and power loom

H200-007-012 Omega LMC to M251 canopen comms cable.

H100-007-012 TM3 expansion module 8 input 24V DC

H200-003-073 USB stick blank FAT32

TS35 DIN Rail for mounting M251 (LMC 410mm)

Also to include instructions - M251 Conversion procedure (LMC)

# TLCC to M251 Conversion Procedure

**ONLY COMPETENT PERSONS TRAINED IN ELECTRICAL MAINTENANCE SHOULD ATTEMPT TO CARRY OUT THIS PROCEDURE. FAILURE TO OBSERVE SAFE WORKING PRACTICES AND FOLLOW THE INSTRUCTIONS IN THIS PROCEDURE COULD LEAD TO SERIOUS INJURY OR DEATH.**

**YOU MUST ISOLATE THE POWER SUPPLY BEFORE PROCEEDING.**

**YOU MUST WAIT FOR AT LEAST 10 MINUTES AFTER ISOLATION OF THE POWER SUPPLY BEFORE WORKING ON THE MACHINE.**

## REMOVE TLCC MOTION CONTROLLER AND WIRING

**A**

Follow the steps below to update the remove the TLCC motion controller and associated wiring :-

**1**

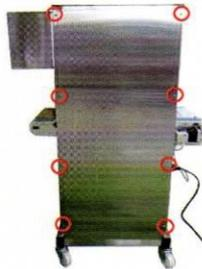

Remove the 8 screws securing the main enclosure cover to gain access to the electrical control panel.

**2**

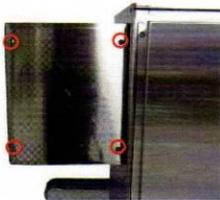

Remove the 4 screws securing the HMI enclosure cover to gain access to the rear of the HMI.

**3**

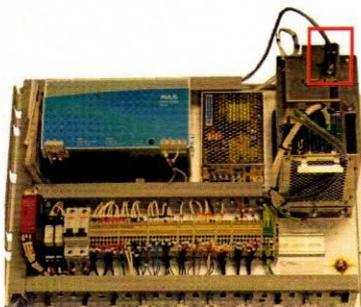

Remove the 'D' connector from the TLCC using a small screwdriver.

4



Remove the 'D' connector from the HMI using a small screwdriver.

5

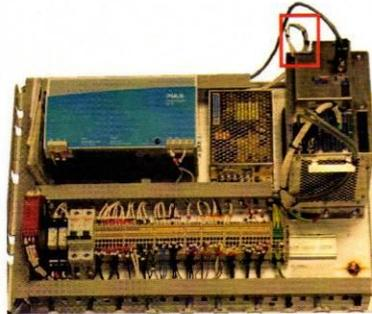

Remove wires to the power supply of the TLCC using a small screwdriver.

6

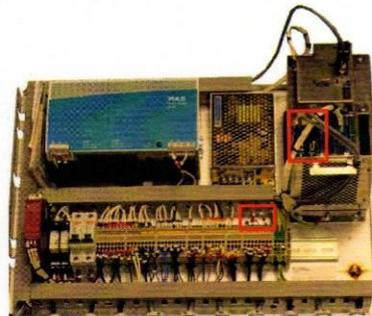

Remove the 2x 'D' connectors from the TLCC using a small screwdriver. Remove the trunking lids. Trace the wires back to the terminals (C1+ / C1- / C2+ / C2-) and remove using a small screwdriver.

7

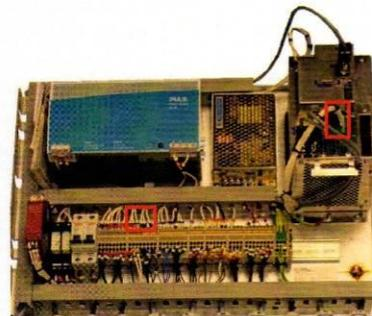

Remove the I/O connector from the TLCC (pull to remove). Trace the wires back to the terminals (I02 to I08) and remove using a small screwdriver. Trace the wire back to the emergency stop relay (I01) and remove with a small screwdriver.

8

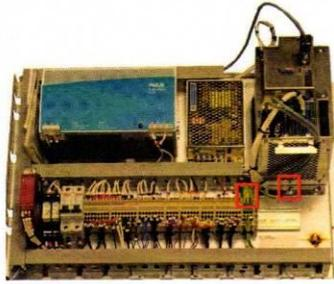

Remove the earth wire from the TLCC using an M8 spanner/socket. Trace the wire back to the terminals and remove using a small screwdriver.

9

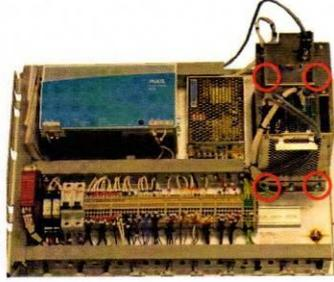

Remove 4x screws using a posidrive screwdriver and remove TLCC motion controller.

## INSTALL M251 MOTION CONTROLLER AND WIRING

**B**

Follow the steps below to install the M251 motion controller and associated wiring :-

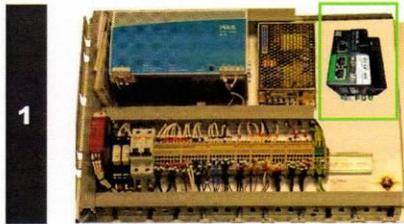

Fix the M251 to the control panel using the fixing kit supplied.



Take the CANOpen comms cable from the conversion kit.

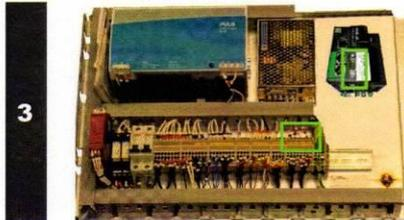

Connect the CAN cable to the port at the top of the M251. Connect the wires at the other end of this cable to the terminals with the corresponding wire numbers (to the same location as the ones previously removed)



Take the IO and power loom from the conversion kit.



Connect the power supply plug to the M251 (connector at bottom).

6

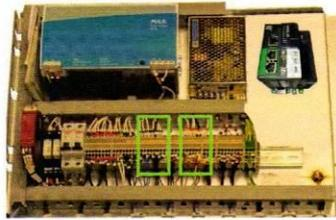

Connect the wires at the other end of the power cable to the terminals with the corresponding wire numbers (to the same location as the ones previously removed).

7

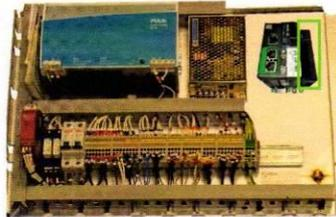

Connect the IO cable plug to the M251 expansion module at the right.

8

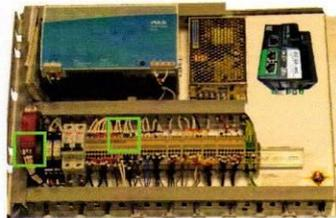

Connect the wires at the other end of the IO cable to the terminals with the corresponding wire numbers (to the same location as the ones previously removed) for wires I02 to I08. Connect I01 to the emergency stop relay connection point 14.

9

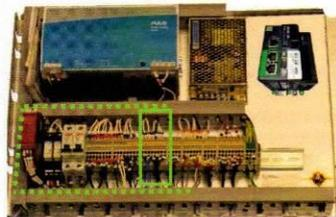

Connect the wire marked 0V to the terminals with the corresponding wire numbers. You will have to find a spare/unused terminal on the terminal rails, this may mean routing the cable to the bottom of the terminals.

10



Remove the Modbus cable from the COM1 connector on the HMI by using a small screw driver to loosen the fastening screws and then pulling to release.

This cable will no longer be used and can be completely removed.



Unplug the HMI power cable and remove the old HMI by loosening and removing the 4x retaining clips with a small posidrive/flat head screwdriver. Then push the HMI out of the cut out.



Fit the new HMI (HMIGTO3210) using the 4x retaining clips supplied in the box with a small posidrive/flat head screwdriver. Then plug in the power connector.



Take the HMI cable from the conversion kit.

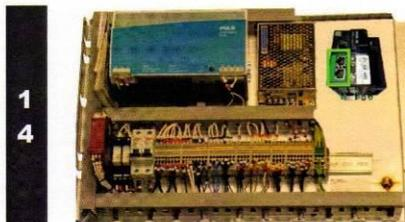

Connect the HMI cable to one of the connectors marked ETHERNET. Ensure that the cable is pushed in firmly, you should hear a "click".



Connect the HMI cable to the connector marked ETHERNET. Ensure that the cable is pushed in firmly, you should hear a "click".

**CONFIGURE MACHINE FOR USE** **C**

Follow the steps below to configure the machine to recognise the connected hardware and to set factory defaults :-

- 1

From the Select Product OR Fault page activate the tools password entry (Hidden button at top left of fault page) and type in **01792561234**
  
- 2

Select the options installed on your machine. Press the exit button.
  
- 3

From the Select Product OR Fault page activate the tools password entry (Hidden button at top left of fault page) and type in **01554777460**
  
- 4

Press the **SET FACTORY DEFAULTS BUTTON**. Then press The **COGS** Button to enter the System Menu.
  
- 5

Select the **DATE/TIME** option to enter the date and time setting page.
  
- 6

Set the Date and Time to the correct settings and press **OK**.

7

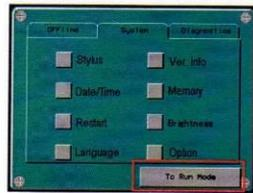

Press the **TO RUN MODE** button to return to the set factory defaults page.

8

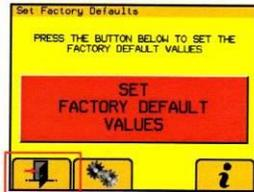

Press the **EXIT** button to return to the main menu.

**CYCLE POWER TO THE MACHINE BEFORE CONTINUING**

**CHECK I/O FUNCTIONALITY** **D**

Follow the steps below to verify that the wiring has been completed correctly and that the I/O to the M251 is correct :-

1



From the Select Product page activate the tools password entry and type in **2808**

2

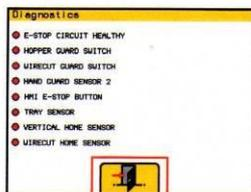

Test that **ALL** inputs are working correctly using the diagnostics page.

Inputs are shown as **RED** for **OFF** and **GREEN** for **ON**.

The E-Stop circuit healthy input will switch if any one of the safety devices is switched (e-stop button / hand guard sensor / hopper guard)

To activate the tray / vertical / wirecut sensors you will need to place a metallic object in front of the sensor.

Press the **EXIT** button when all inputs are verified OK.

**YOU MUST ISOLATE THE POWER SUPPLY BEFORE PROCEEDING.**  
**YOU MUST WAIT FOR AT LEAST 10 MINUTES AFTER ISOLATION OF THE POWER SUPPLY BEFORE WORKING ON THE MACHINE.**

If the machine was previously running with a TLCC software version of v1.0, v1.1, v1.2 or v1.3 then the motor configuration will need to be updated in order for the machine to function :-

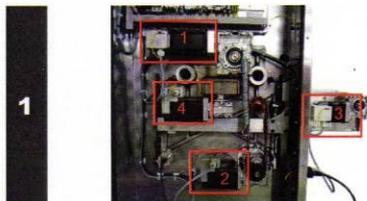

Identify the motors present in the rear of the machine.

- 1 – Pump Motor
- 2 – Jog Motor
- 3 – Tray Motor
- 4 – Rotary Motor



To access the tray motor remove the cover plate. There are 2 screws on the top and 2 screws on the bottom

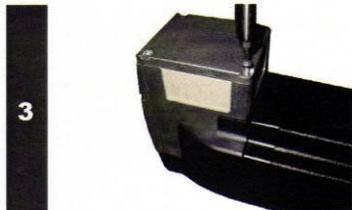

Locate the motor control box for each motor and remove the 4 screws to gain access (tamper proof screws).



Remove the motor control box lid.

5



Slide the cable gland plate from the motor housing to gain access to the connectors.

6

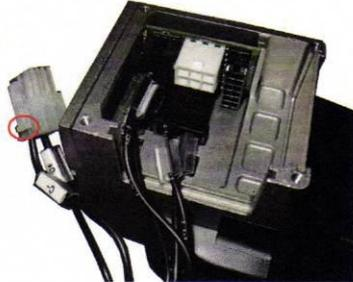

Carefully remove the CAN connector, press the locking pin to release and pull to remove.

7



Carefully remove the I/O connector, press the locking pin to release and pull to remove.

8

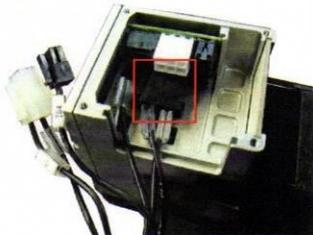

Carefully remove the POWER connector, pull to remove (long nosed pliers can be used).

9

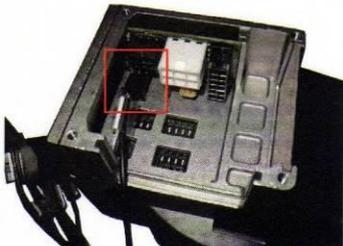

Do **NOT** remove the STOP connector, this cable can be moved out of the way to gain access to the switches.

1  
0

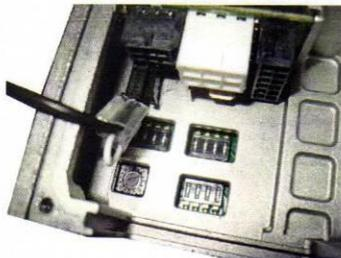

Using a small screwdriver adjust the settings of the switches and rotary dial as per the motor configurations below.

1  
1

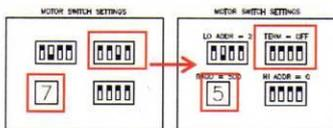

**Pump Motor (Standard)**  
Set the rotary dial to 5 and the DIP switches to the settings shown.

1  
2

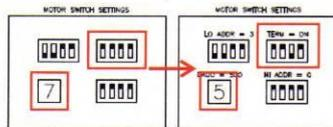

**Jog Motor**  
Set the rotary dial to 5 and the DIP switches to the settings shown.

1  
3

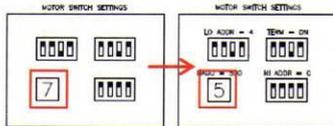

**Tray Motor**  
Set the rotary dial to 5 (as shown)

1  
4

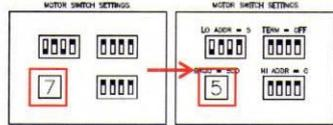

**Rotary Motor**  
Set the rotary dial to 5 (as shown)

1  
5



Re-fit all the motor wiring connectors (in reverse order to removal) and fit the gland plate in place.

1  
6

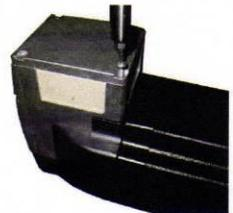

Re-fit the motor control box lid for each motor (ensure that the earth cable is connected).

# LMC20 to M251 Conversion Procedure

**ONLY COMPETENT PERSONS TRAINED IN ELECTRICAL MAINTENANCE SHOULD ATTEMPT TO CARRY OUT THIS PROCEDURE. FAILURE TO OBSERVE SAFE WORKING PRACTICES AND FOLLOW THE INSTRUCTIONS IN THIS PROCEDURE COULD LEAD TO SERIOUS INJURY OR DEATH.**

**YOU MUST ISOLATE THE POWER SUPPLY BEFORE PROCEEDING.**

**YOU MUST WAIT FOR AT LEAST 10 MINUTES AFTER ISOLATION OF THE POWER SUPPLY BEFORE WORKING ON THE MACHINE.**

## REMOVE LMC20 MOTION CONTROLLER AND WIRING

**A**

Follow the steps below to update the remove the LMC20 motion controller and associated wiring :-

**1**

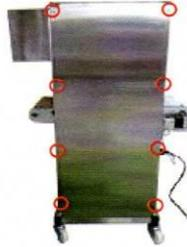

Remove the 8 screws securing the main enclosure cover to gain access to the electrical control panel.

**2**



Remove the 4 screws securing the main enclosure lid (2 on each side) using 1 4mm allen key and 10mm spanner/socket to gain access to the electrical control panel. To remove the lid lift the lid at the front and slide to the rear then lift to remove.

**3**

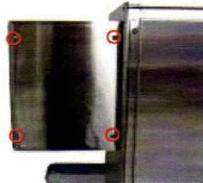

Remove the 4 screws securing the HMI enclosure cover to gain access to the rear of the HMI.

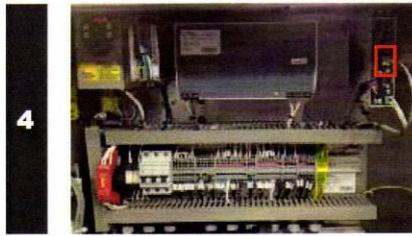

4

Remove the Modbus cable from the Modbus connector on the LMC20 by pressing the small tab on the connector and pulling.



5

Remove the Modbus cable from the RS485 connector on the HMI by pressing the small tab on the connector and pulling.

This cable will no longer be used and can be completely removed.

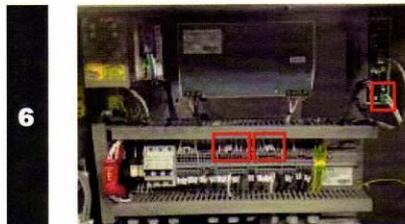

6

Remove the wires to the power supply of the LMC20 by pulling the green connector. Remove the trunking lids. Trace the wires back to the terminals (0V / 24V) and remove using a small screwdriver.



7

Remove the 'D' connector from the bottom of the LMC20 by pulling the connector. Trace the wires back to the terminals (C+ / C-) and remove using a small screwdriver.

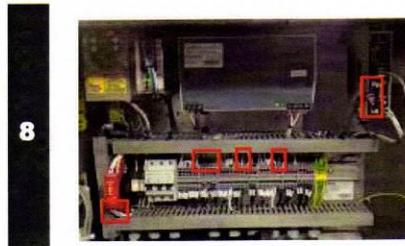

8

Remove the I/O connector from the LMC20 by releasing the retaining clips (top and bottom) and pulling the cable. Trace the wires back to the terminals (I01 to I07, 0V, 24V) and remove using a small screwdriver. Trace the wire back to the emergency stop relay (I00) and remove with a small screwdriver.

9



Unscrew the LMC20 from its mounting bracket using a posidrive screwdriver (you will need to access from the top of the machine). Then pull the LMC20 forward from the top, and then lift to remove from the mounting bracket.

10

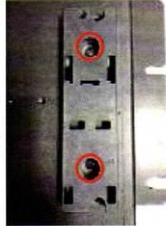

Remove 2x screws using a posidrive screwdriver and remove LMC20 mounting bracket.

## INSTALL M251 MOTION CONTROLLER AND WIRING

**B**

Follow the steps below to install the M251 motion controller and associated wiring :-

- 1**

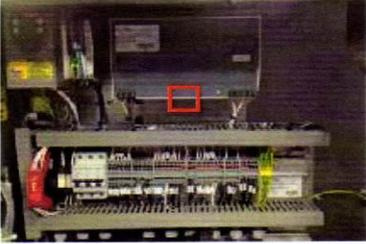

Release the 36 Volt power supply from the DIN rail by using a large flat head screwdriver to pull down on the retaining clip. Lift the power supply off the DIN rail.
- 2**

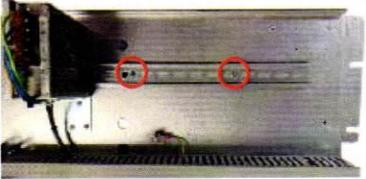

Remove the 2x DIN rail screws using a posidrive screwdriver and remove the DIN rail.
- 3**

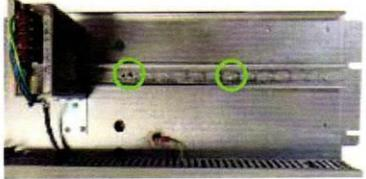

Fix the extended DIN rail in place using the 2x screws.
- 4**

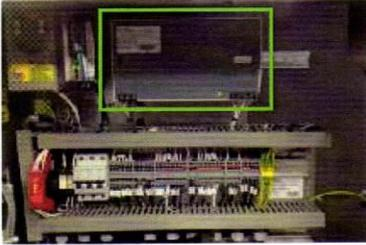

Fix the 36 Volt power supply onto the DIN rail – ensure it is mounted securely.
- 5**

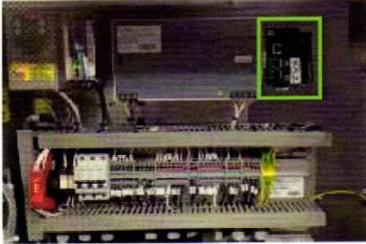

Fix the M251 to the DIN rail – ensure that the 3x retaining clips are in the out position before offering up to the DIN rail, then use a screwdriver to push the 3x retaining clips in – ensure it is mounted securely.
- 6**



Take the CANOpen comms cable from the conversion kit.

7

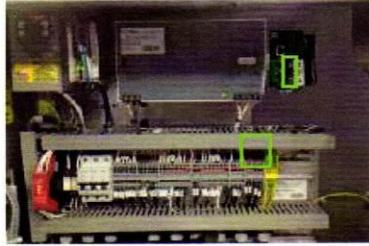

Connect the CAN cable to the port at the top of the M251. Connect the wires at the other end of this cable to the terminals with the corresponding wire numbers (to the same location as the ones previously removed)

8



Take the IO and power loom from the conversion kit.

9

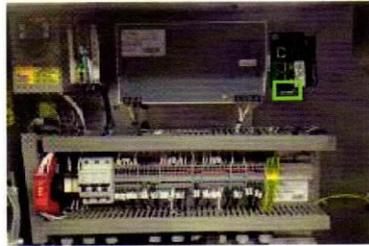

Connect the power supply plug to the M251 (connector at bottom). Note the retaining shroud hinges up to enable the connector to be inserted, insert then hinge the shroud down to fully engage.

10

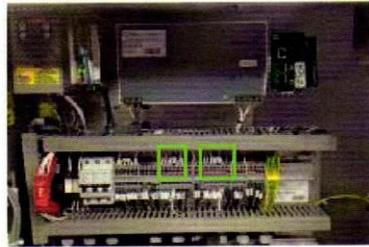

Connect the wires at the other end of the power cable to the terminals with the corresponding wire numbers (to the same location as the ones previously removed).

11

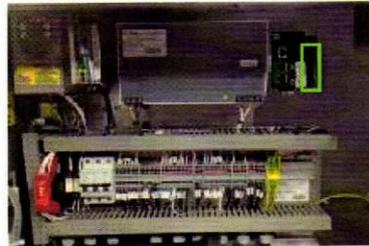

Connect the IO cable plug to the M251 expansion module at the right. Push the connector into the housing – ensure it is fully engaged.

12



Connect the wires at the other end of the IO cable to the terminals with the corresponding wire numbers (to the same location as the ones previously removed) for wires I01 to I07 and 0V. Connect I00 to the emergency stop relay connection point 14.

**IF YOU ALREADY HAVE THE HMIGTO2310 FITTED SKIP TO STEP 15**

**1  
3**



Unplug the HMI power cable and remove the old HMI by loosening and removing the 4x retaining clips with a small posidrive/flat head screwdriver. Then push the HMI out of the cut out.

**1  
4**

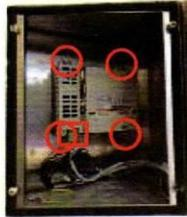

Fit the new HMI (HMIGTO3210) using the 4x retaining clips supplied in the box with a small posidrive/flat head screwdriver. Then plug in the power connector.

**1  
5**



Take the HMI cable from the conversion kit.

**1  
6**



Connect the HMI cable to one of the connectors marked ETHERNET. Ensure that the cable is pushed in firmly, you should hear a "click".

**1  
7**



Connect the HMI cable to the connector marked ETHERNET. Ensure that the cable is pushed in firmly, you should hear a "click".

## CONFIGURE MACHINE FOR USE

**C**

Restore power to the machine. Follow the steps below to configure the machine to recognise the connected hardware and to set factory defaults :-

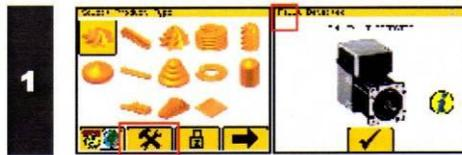

From the Select Product *OR* Fault page activate the tools password entry (Hidden button at top left of fault page) and type in **01792561234**



Select the options installed on your machine. Press the exit button.



From the Select Product *OR* Fault page activate the tools password entry (Hidden button at top left of fault page) and type in **01554777460**



Press the **SET FACTORY DEFAULTS BUTTON**. Then press The **COGS** Button to enter the System Menu.

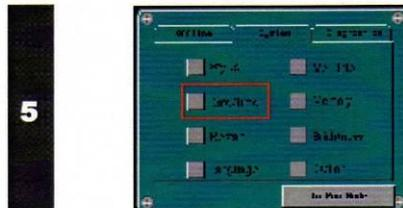

Select the **DATE/TIME** option to enter the date and time setting page.

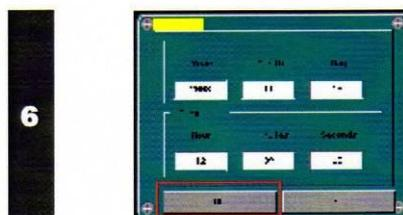

Set the Date and Time to the correct settings and press **OK**.

7

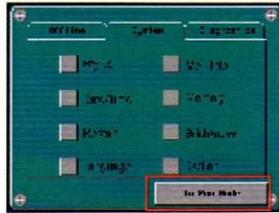

Press the **TO RUN MODE** button to return to the set factory defaults page.

8



Press the **EXIT** button to return to the main menu.

**CYCLE POWER TO THE MACHINE BEFORE CONTINUING**

**CHECK I/O FUNCTIONALITY** **D**

Follow the steps below to verify that the wiring has been completed correctly and that the I/O to the M251 is correct :-

1

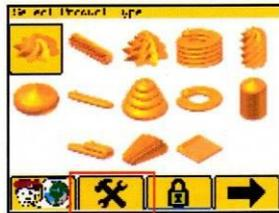

From the Select Product page activate the tools password entry and type in **2808**

2

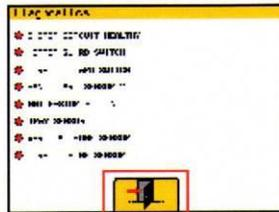

Test that **ALL** inputs are working correctly using the diagnostics page.

Inputs are shown as **RED** for **OFF** and **GREEN** for **ON**.

The E-Stop circuit healthy input will switch if any one of the safety devices is switched (e-stop button / hand guard sensor / hopper guard)

To activate the tray / vertical / wirecut sensors you will need to place a metallic object in front of the sensor.

Press the **EXIT** button when all inputs are verified OK.