



MonoEquip.com

# MONO Eco Connect Convection Oven

EN

## Installation and Operation Manual



Oven Serial Number \_\_\_\_\_

Oven Code    138    149    150    153    158    159    170    173

Condenser Serial Number \_\_\_\_\_ (if fitted)

In the event of an enquiry, please quote these serial numbers.



## DECLARATION OF CONFORMITY

We hereby declare that this machine complies with the essential health and safety requirements of :-

- The Machinery Directive 2006 / 42 / EC
- The Low voltage Directive 2006 / 95 / EC
- The requirements of the Electromagnetic Compatibility Directive 2004 / 108EC, 91 / 263 / EEC, 92 / 31 / EEC
- The General Safety of Machinery and food processing Standards applicable
- Materials and Articles intended to come into contact with food - Regulation (EC) No. 1935 / 2004
- Good manufacturing practice for Materials intended to come into contact with food - Regulation (EC) No. 2023 / 2006

<b>Signed</b>	
<b>D. Osmundsen – Quality and Conformance Manager</b>	

<b>Date</b>	
-------------	--

<b>Machine FG Code.</b>		<b>Machine Serial No.</b>	
-------------------------	--	---------------------------	--

A technical construction file for this machine is retained at the following address:

**MONO EQUIPMENT**  
 Queensway,  
 Swansea West Industrial Park,  
 Swansea  
 SA5 4EB  
 UK

**MONO EQUIPMENT** is a business name of **AFE GROUP Ltd**  
 Registered in England No.3872673    VAT registration No.923428136

Registered office: Unit 35,  
 Bryggen Road,  
 North Lynn Industrial Estate,  
 Kings Lynn Norfolk,  
 PE30 2HZ

# ATTENTION

If the oven fails to heat up when first connected to a power supply or during use at any time, press the reset buttons located on the rear back panel.

(Do not remove the back panel)

If this fails to correct the situation, please contact your supplier.

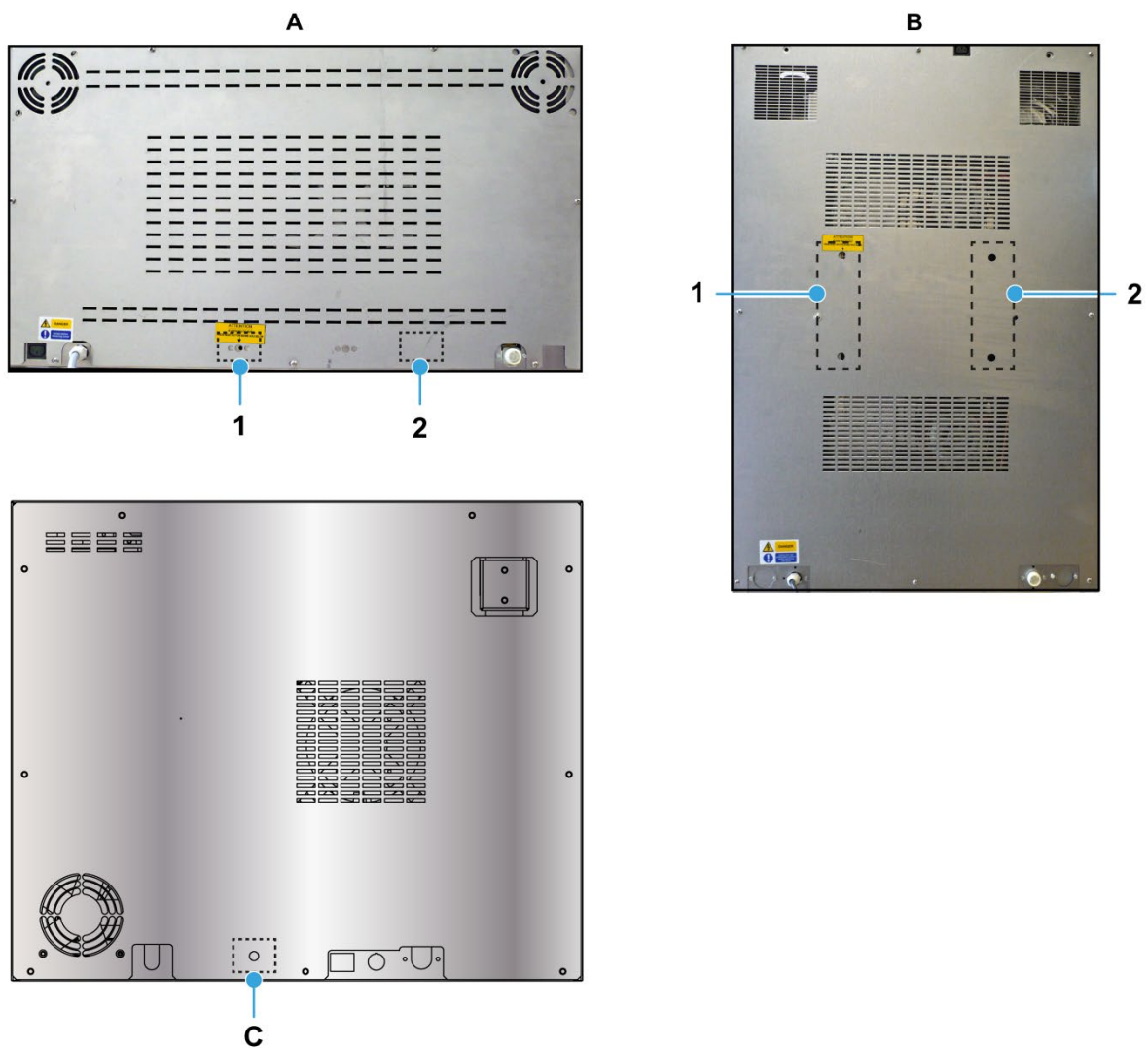

- 
- A. Rear panel of 4/5-tray oven. The reset-button hole can be at position **1** or **2** depending on the model
  - B. Rear panel of 10-tray oven. The reset-button hole can be at position **1** or **2** depending on the model
  - C. Reset-button hole on the rear panel of a 7-tray oven
-

# How to open the double-catch door

1. Turn the handle **left** to release the catch halfway.
  - This step allows the steam and heat to escape.
2. Turn the handle **right** to release the door fully.
3. Open the door.



## NOTE

- These instructions apply to both left-hand and right-hand ovens.
- Close the door by just pushing it shut.



Closed-door



Step 1. Turn left



Step 2. Turn right

## Safety Symbols

The following safety symbols are used throughout this product manual. Before using your new equipment, read the instructions carefully and pay special attention to the information marked with the following symbols:



### DANGER

Indicates an immediate hazard with a high risk of death or serious physical injury if not avoided.



### WARNING

Indicates a potential hazard with a medium risk that could result in death or serious physical injury if not avoided.



### CAUTION

Indicates a hazardous situation that could result in minor or moderate injury if not avoided.

# Electrical Safety Notice



## Electrical safety and advice regarding supplementary electrical protection

Commercial kitchens and food service areas are environments where electrical appliances may be located close to liquids, operate in and around damp conditions or where restricted movement for installation and service is evident.

The appliance installation and periodic inspection should only be undertaken by a qualified, skilled, and competent electrician and connected to the correct power supply suitable for the load as stipulated by the appliance data label.

The electrical installation and connections should meet the mandatory requirements of the local electrical wiring regulations and any safety guidelines.

### We recommend:

- Supplementary electrical protection with the use of a residual current device (RCD)
- Fixed wiring appliances should also incorporate a locally situated switch disconnector to connect to, which is easily accessible for switching off and safe isolation purposes. The switch disconnector must meet the specification requirements of IEC 60947.

### Your attention is drawn to the following:

#### BS 7671:2018 – Guidance Note 8 – 8.13: Other locations of increased safety risk

It is recognised that there may be locations of increased risk of electrical shock other than those specifically addressed in Part 7 of BS 7671. Examples of such locations could include laundries, where washing and drying machines are nearby, and water is present, and commercial kitchens with stainless steel units where, once again, water is present. Where, because of the perception of additional risks being likely, the installation designer decides that an installation or location warrants further protective measures, the options available include:

- Automatic Disconnection of Supply (ADS) using a residual current device having a residual operating current not exceeding 30 mA;
- Supplementary protective equipotential bonding; and
- Reduction of maximum fault clearance time.

The provision of RCDs and supplementary bonding must be specified by the host organisation's appointed installation designer or electrical contractor and installed by a suitably qualified and competent electrician to comply with Regulations 419.2 and 544.2.



### WARNING

- The supply to this machine must be protected by a 30mA-rated Type 'A' Residual Current Device (RCD).
  - Before installation, it is recommended that a qualified and competent electrician first tests the electrical outlet (power socket) for electrical safety.
-

# Water Leak Safety Notice

**WARNING**

- **Take action immediately to get a water leak fixed and prevent death or serious injury from electrocution.**

It is essential to regularly check for any signs of a water leak from an oven installation. If there is evidence of a water leak, do not ignore it. Immediately report it to a manager or as applicable to your organisation.

Furthermore:

- Disconnect or completely isolate the oven from the electrical supply (see **Isolation** section on page 19).
- Place an out-of-service notice on the oven.
- Contact your oven supplier or MONO Equipment for technical assistance.

Ovens must be maintained and serviced at appropriate intervals to ensure the oven operates at optimum levels. See the Maintenance section on page 59.

## General Notices

**NOTICES****■ Warranty information**

- Ambient working temperatures for electrical components, such as solenoid switches, circuit breakers and motors, should not exceed 40 °C (115 °F). Manufacturers of these, and other electrical components, advise that any ambient temperature above this affects the functionality of the components. Any related guarantees become void.
- It is the owners' responsibility to ensure adequate ventilation is provided. Any component malfunctioning during the guarantee period found to have been subjected to excessive humidity or ambient working temperatures is not covered by the component manufacturer's or MONO Equipment's product warranty.
- Failure to adhere to the cleaning and maintenance instructions detailed in this User Manual also could affect the warranty of this machine.
- Visit the [MONO Parts and Labour Warranty page](#) for further information.

**■ Continuous improvements**

- Our policy is to improve our machines continuously, and we reserve the right to change specifications without prior notice.

**■ Engineers/Electricians-only sections of the User Manual**

- Technical sections of this User Manual are for suitably experienced and qualified persons (SEQP) only. Customers must never make any modifications or repairs to MONO's machines.

# Contents

	<b>Page</b>
<b>1. Introduction</b> .....	<b>9</b>
<b>2. Specifications</b> .....	<b>11</b>
Mechanical specifications.....	11
Electrical specifications .....	12
Environmental specifications .....	13
<b>3. Safety</b> .....	<b>14</b>
<b>4. Installation</b> .....	<b>16</b>
Power supply .....	16
Water supply.....	17
Ventilation .....	17
Before use .....	17
Before use .....	17
Ambient working temperatures.....	18
<b>5. Isolation</b> .....	<b>19</b>
Electrical supply.....	19
Water supply.....	19
<b>6. Touchscreen Operations</b> .....	<b>20</b>
Starting and operating using ready-made recipes (programs).....	21
Manual bake (no program mode).....	25
Setting the time and date.....	27
Setting up a new program .....	29
Multi bake operation .....	32
7–Day Timer .....	35
Putting the oven into Standby mode .....	37
Putting the oven into Sleep mode .....	37
User settings (oven setup).....	38
Factory settings (oven setup) .....	41
Changing the passwords .....	43
Diagnostics .....	45
<b>7. Using the USB port</b> .....	<b>47</b>
Using the USB port to import recipes .....	47

<b>8. Cleaning</b> .....	<b>53</b>
Cleaning guide for the ECO Convection Oven.....	53
Daily cleaning instructions .....	53
Weekly cleaning instructions .....	54
Monthly cleaning instructions .....	55
<b>9. Maintenance</b> .....	<b>59</b>
General maintenance .....	59
Steam system maintenance .....	59
Light bulb replacement .....	59
<b>10. Spare Parts</b> .....	<b>60</b>
Part 1: FG150 10-tray oven spares section.....	61
Part 2: FG159 4/5-tray 18" x 30" oven spares section .....	70
Part 3: FG158 4/5-tray 60cm x 40cm oven spares section .....	78
Part 4: FG153 4/5-tray 40cm x 60cm oven spares section .....	86
<b>11. Condenser Unit (Option)</b> .....	<b>94</b>
<b>12. Passwords</b> .....	<b>113</b>



# 1. Introduction

**Thank you for purchasing this MONO Eco Connect Oven.**  
*“A combination of clean industrial design and the latest technology.”*

- The MONO convection oven range is designed to take the baking Industry’s standard trays.
- Ovens in the range are of **stainless steel construction**, and selected models have removable tray racks to make cleaning easier.
- The smaller ovens are designed to be **stackable** without separate support, so your business can grow without taking up more ground space.
- The high-speed fans, elements and steam systems give **efficient air circulation** to produce a professional bake across a product range.
- The doors are **double-glazed** to increase the efficiency of the oven’s well-insulated baking chamber.
- Ovens are fitted with user-friendly touchscreen display panels.
- The 10-tray oven has a 10-tray capacity stainless steel base with locking castor wheels.
- An optional condenser unit can be fitted to a single oven or stacked ovens. The unit can be adjusted using the thermostatic control to operate in most ambient room temperatures.

**Figure 1: MONO Eco Connect Oven features**

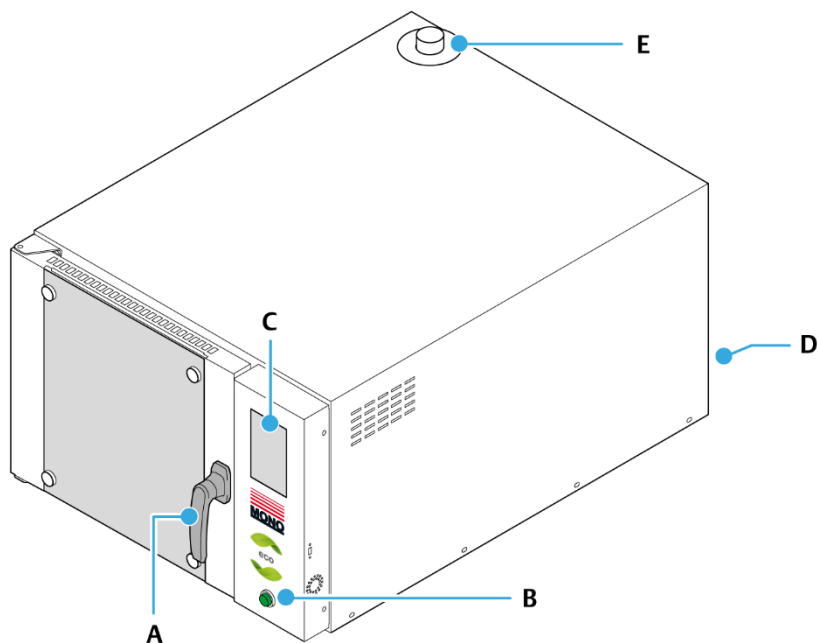

- A. Double-latch door handle – see page 4
- B. Power On/Off switch
- C. Touchscreen
- D. Identification / Serial number plate
- E. Damper flue – do not cover the flue

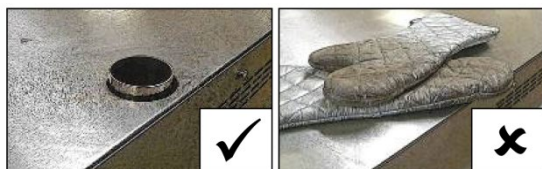

**Figure 2: Optional condenser**



## 2. Specifications

### Mechanical specifications

**Table 1: Mechanical specifications**

	4/5-Tray				7-Tray	10-Tray		
	FG159	FG153	FG158	FG173	FG138	FG150	FG149	FG170
Tray size (mm)	-	400 x 600	600 x 400	400 x 800	400 x 600	-	-	-
Tray size (inches)	18 x 30	-	-	-	-	18 x 30	400 x 600	400 x 800
Distance between trays	93 mm	93 mm	84 mm			100 mm	100 mm	100 mm
Height (oven only)	525 mm	525 mm	570 mm	570 mm	655 mm	1170 mm	1170 mm	1170 mm
Height (oven + base)	-	-	-	-	1255 mm	1870 mm	1870 mm	1870 mm
Width	840 mm	780 mm	1000 mm	780 mm	780 mm	840 mm	780 mm	780 mm
Depth, door closed <sup>(1)</sup>	1269 mm	1103 mm	890 mm	1103 mm	1103 mm	1209 mm	1109 mm	1309 mm
Depth, door open <sup>(1)(2)</sup>	1828 mm	1610 mm	1610 mm	1810 mm	1610 mm	1770 mm	1609 mm	1809 mm
Weight (kg), approximate	165	115	110	160	125	290	250	262
Total power required (kW)	8.5	7.5	7.5	7.5	10	17	15	17
Water supply <sup>(3)</sup>	■	■	■	■	■	■	■	■
Modularity	■	■	■	■	■	■	■	■
Landscape tray orientation			■					
Portrait tray orientation	■	■		■	■	■	■	■
Single phase electrics <sup>(4)</sup>	■	■	■					
Three phase electrics <sup>(4)</sup>	■	■	■	■	■	■	■	■
Steam function	■	■	■	■	■	■	■	■
Damp function	■	■	■	■	■	■	■	■
LED door lights	■	■	■	■	■	■	■	■
Stackable	■	■	■	■	<sup>(6)</sup>			
Variable fan speed	No	No	No	No	No	No	No	No
<b>Optional extras</b>								
Calcium treatment unit	□	□	□	□	□	□	□	□
Water condenser <sup>(5)</sup>	□	□	□	□	□	□	□	□
Valance	□	□	□	□	□	□	□	□
Base unit <sup>(7)</sup>	□	□	□	□	□			

<sup>(1)</sup> Includes the handle.

<sup>(2)</sup> Excluding services. Allow room for water and electrical supply connections.

<sup>(3)</sup> See the **Water** section on pages 17 and 19 for further information.

<sup>(4)</sup> See the **Power** section on pages 12 and 16 for further information.

<sup>(5)</sup> See the **Condenser Unit** chapter on page 94.

<sup>(6)</sup> Can be stacked with a 4/5-tray oven only.

<sup>(7)</sup> Base units are 300 mm up to 920 mm high.

■ Available

□ Optional extra

## Electrical specifications

### Power supply



#### WARNING

- An electrical socket must be protected by a 30mA-rated Type A Residual Current Device (RCD) before installation and commissioning of the oven.
- Always fit a wall-mountable isolator switch to isolate the oven entirely from the electrical supply in an emergency. The isolator must be visible, labelled as an emergency shutdown device, and easily accessible.
- Check that the electrical requirements on the oven's information plate match the supply before connecting the power cable and turning the power on for the first time.

**Table 2: Oven supply specifications**

Oven		Electrical supply	Fused at	Total Power (kW)
4/5-Tray	18" x 26"	240 Vac (50 Hz), 1-phase	40 Amps	7.5
	26" x 18"			
	18" x 30"			
	40cm x 60cm			
	60cm x 40cm			
	40cm x 80cm			
	18" x 26"	380 Vac (50 Hz), 3-phase + neutral + earth	(Contact factory)	(Contact factory)
	26" x 18"			
	18" x 30"			
	40cm x 60cm			
	60cm x 40cm			
	40cm x 80cm			
	18" x 26"	415 Vac (50 Hz), 3-phase + neutral + earth	11 Amps per phase	7.5
	26" x 18"			
40cm x 60cm				
60cm x 40cm				
40cm x 80cm				
18" x 30"	414 Vac (50 Hz), 3-phase + neutral + earth	12 Amps per phase	8.5	
7-Tray	40cm x 60cm	240 Vac (50 Hz), 1-phase	45 Amps	10
		380 Vac (50 Hz), 3-phase + neutral + earth	(Contact factory)	(Contact factory)
		415 Vac (50 Hz), 3-phase + neutral + earth	14 Amps per phase	10
10-Tray	18" x 26"	380 Vac (50 Hz), 3-phase + neutral + earth	(Contact factory)	(Contact factory)
	18" x 30"			
	40cm x 60cm			
	40cm x 80cm			
	18" x 26"	415 Vac (50 Hz), 3-phase + neutral + earth	32 Amps	17
	18" x 30"			
	40cm x 60cm			
40cm x 80cm				

## Power cable

- 2.5 metres of cable factory-fitted with a LEGRAND (or equivalent) plug

## Display

- 7-inch HD TFT resistive touchscreen, portrait format

## Environmental specifications

**Table 3: Environmental**

<b>Noise level</b>	Less than 85 dB
<b>Water supply</b>	Required. See pages 17 and 19
<b>Drainage</b>	Not required

## 3. Safety

Only fully trained and authorised persons are permitted to work on the oven. Qualified electricians must carry out all repairs and maintenance. Always disconnect or isolate the power supply before starting maintenance or cleaning work on the oven.

A responsible Bakery Manager or Supervisor must carry out daily safety checks. Bakery staff **must not**, under any circumstances, remove covers or panels to access any part of the oven.



### DANGER

- Never use the USB port to power or recharge electronic devices, e.g. mobile phones. Incorrect usage causes damage to the oven and could result in a fire.
- 



### WARNING

- Before using the oven:
    - Ensure all covers, panels, cables, and pipe fittings are secure.
    - Visually examine the oven for apparent damage or signs of tampering.
  - If the oven is damaged or malfunctioning, or missing parts:
    - Stop using it.
    - Do not attempt any repairs.
    - Contact MONO Equipment for technical assistance.
  - Never operate the oven with any covers or panels removed.
  - All utility connections to the oven must comply with the statutory requirements of the country where the oven is installed.
  - Ensure this product manual is read thoroughly before operating the oven. Operate and maintain the oven only as described in this product manual.
- 



### WARNING

- An electrical socket must be protected by a 30mA-rated Type 'A' Residual Current Device (RCD) before installation and commissioning of the oven.
  - Always fit a wall-mountable isolator switch to isolate the oven entirely from the electrical supply in an emergency. The isolator must be visible, labelled as an emergency shutdown device, and easily accessible.
  - Check that the electrical requirements on the oven's information plate match the supply before connecting the power cable and turning the power on for the first time.
  - Before installation, it is recommended that a qualified and competent electrician first tests the electrical outlet (power socket) for electrical safety.
  - Always ensure your hands are dry before touching any electrical components, including cables, switches, and plugs.
-

**CAUTION**

- Be aware of hot surfaces:
    - Do not touch the oven door with bare skin.
    - Always use oven gloves when loading or unloading the oven.
    - Allow time for the oven to cool down before cleaning it. To prevent door glass from shattering, do not clean the oven glass when hot.
    - While the oven is in operation (and for some time after use), touching the oven window or the surrounding panels is inadvisable because of conducted heat.
  - When removing products from the oven, ensure the following:
    - Tins are knocked out and stored directly onto a tin storage trolley or rack. Do not leave hot tins on the floor or tables.
    - Trays are put into a rack and then wheeled to a safe cooling area.
  - Fully train operatives before they use the oven. Anyone undergoing training must be under the direct supervision of someone experienced.
  - Ensure there are no trip hazards around the oven, e.g. trailing cables.
  - Check that the floor around the oven is not slippery, e.g. no liquid spills.
  - Do not store items on top of or behind the oven.
  - Never climb onto the roof of the oven.
  - Only use the oven for baking bread, pastries, and cakes. Contact MONO Equipment for other product-baking machines.
  - No unauthorised modifications to the oven are permitted.
-

# 4. Installation

## Power supply



**WARNING**

- An electrical socket must be protected by a 30mA-rated Type A Residual Current Device (RCD) before installation and commissioning of the oven.
- Always fit a wall-mounted isolator switch to isolate the oven entirely from the electrical supply in an emergency. The isolator must be visible, labelled, and easily accessible by an operator.
- Check that the electrical requirements on the oven’s information plate match the supply before connecting the power cable and turning the power on for the first time.

**Figure 3: Main power supply connections**

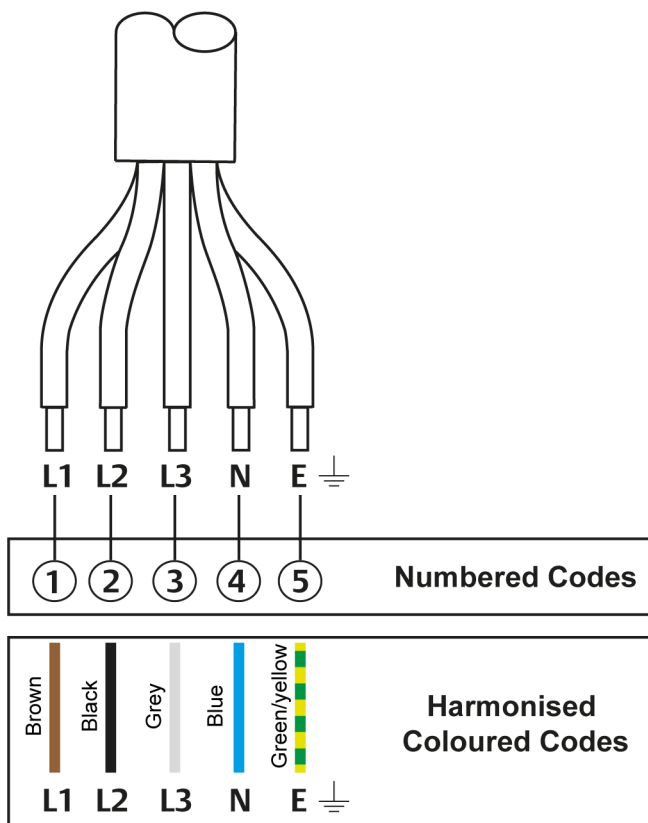

**NOTE**

- L2 and L3 are for three-phase installations only.
- See the **Specifications** section for electrical specifications.



## Water supply

Connect to a suitable water supply, ensuring the pipes are flushed out to remove all foreign bodies, i.e., flux or solder. When operating the oven in a hard water area, ensure that an efficient water-softening device protects the water supply to the equipment. MONO Equipment is not responsible for installing and maintaining an adequate water supply to the oven, which should comply with local water regulations.

- The oven ships with a one-metre flexible hose – ¾-inch BSP connections (both ends).
- Water pressure requirements: 2 to 4 bar
  - Domestic pressure is usually within this parameter.
- Water conditioning unit advised.
- No drain is required (unless fitting a condenser).

## Ventilation

It is the customer's sole responsibility to arrange for adequate ventilation. It should be sufficient to ensure water does not condense on or around the oven.

- Allow a 50 mm gap at the sides and rear of this oven.
- Chimneys and evacuation ducts fitted above MONO ovens should be insulated.

## Before use

For hygiene reasons, MONO Equipment highly recommends thoroughly wiping the inside of the oven and all accessories with a clean cloth soaked in warm soapy water before using the oven for the first time. Although the utmost care is taken during assembly and pre-delivery inspection, there is always a possibility of residue contaminating the first bake if this is not done.

Ensure that the locking casters on the base unit (if supplied) are locked into position.

## Safety

- Review the safety information on **page 14**.
- Allow sufficient space for the oven door to open fully and easy loading and unloading of product trays without people coming in contact with hot surfaces.
- Racks should be available to allow cooked products to cool safely.
- Oven gloves should be available at all times.



### NOTE

- This Installation and Operating Manual is available in Adobe PDF format at [www.monoequip.com](http://www.monoequip.com).
-

## Ambient working temperatures

Ambient working temperatures for electrical components, such as solenoid switches, circuit breakers, and motors, **should not exceed 40 °C (115 °F)**. Manufacturers of these, and other electrical components, advise that any ambient temperature above 40 °C (115 °F) affects the functionality of the components, and any related guarantees become void. For example, motors are not sufficiently cooled, contactor efficiency is seriously impaired, and electronic components shut down.

It is the customer's sole responsibility to arrange for adequate ventilation. Any component malfunctioning during the guarantee period found to have been subject to excessive humidity or ambient working temperature above 40 °C (115 °F) would not be covered by the component manufacturer guarantee or MONO's product warranty.

# 5. Isolation

## Electrical supply

To stop the oven **in an emergency**, switch off the electricity using the wall-mounted isolator switch.

## Water supply

**In an emergency**, shut off the water supply to stacked ovens by closing the shut-off valves (**Figure 4**).

**Figure 4:** View of rear connections on a MONO Eco Connect Convection Oven

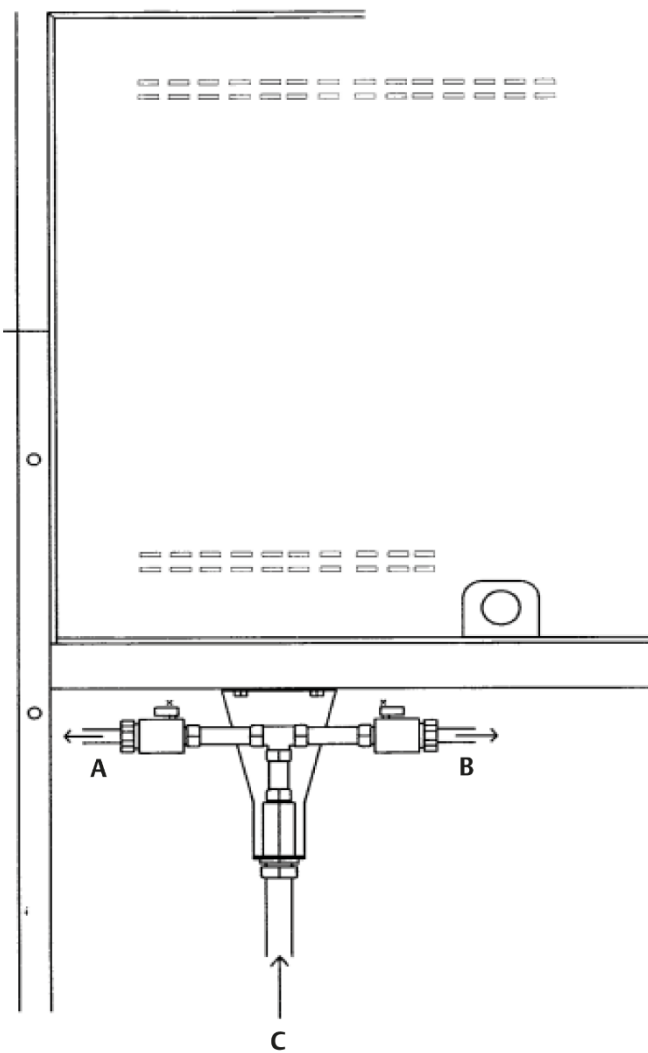

Turn the appropriate valve 90° anti-clockwise (↺) to turn off the water supply.

- A. Top oven supply
- B. Bottom oven supply
- C. Supply from water filter

# 6. Touchscreen Operations

Operations are performed by touching an area of the screen, bringing up the next information panel or activating a function.



**CAUTION** ■ Do not use excessive force to operate the touchscreen panel.

**Figure 5: Main screen**

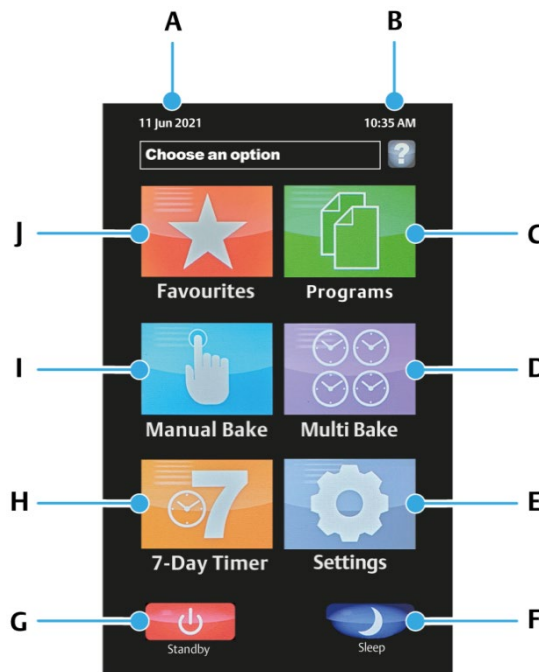

Callout	Function	Purpose of the function
A	Date	It shows the current date.
B	Time	It shows the current time.
C	Programs	Access to saved baking recipe programs. Creation of programs.
D	Multi Bake	Creation of up to four simultaneous bakes with different timings.
E	Settings	Access to oven settings.
F	Sleep	Sleep mode – see page 37.
G	Standby	Standby mode – see page 37.
H	7-Day Timer	Create an oven on/off schedule for every day of the week.
I	Manual Bake	Baking using manual controls.
J	Favourites	Easy selection of most frequently used baking recipe programs.

**NOTE:** The images are for illustration purposes and may differ from your oven.

## Starting and operating using ready-made recipes (programs)

1. Ensure the electrical and water supplies are safely connected to the oven (see **Installation** on page 16).
2. If the display (A) is blank, press the green Power ON/OFF button (B) on the front panel. The oven then goes through a boot-up sequence. Please wait.

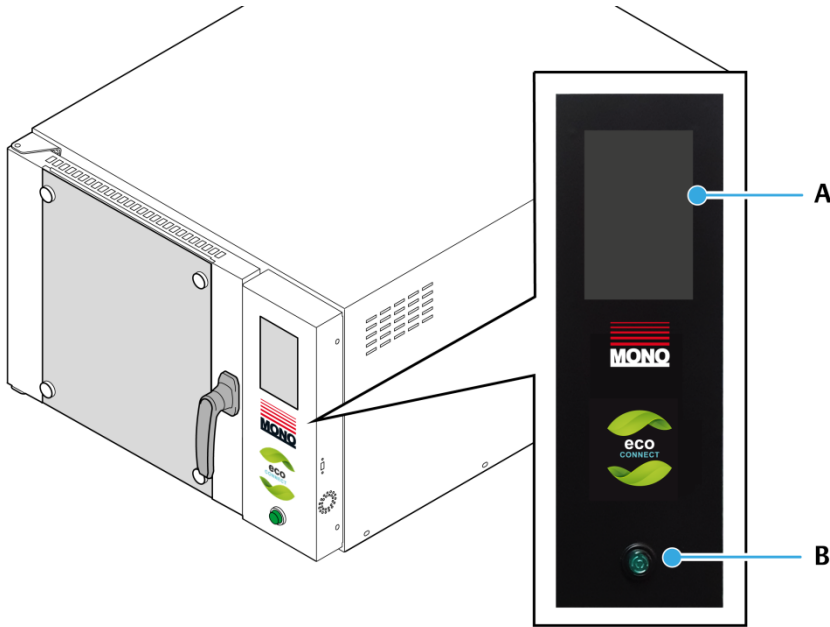

**NOTE**

The images are for illustration purposes and may differ from your oven.

3. When a start-screen (wallpaper) appears, touch the screen anywhere to display the main screen.

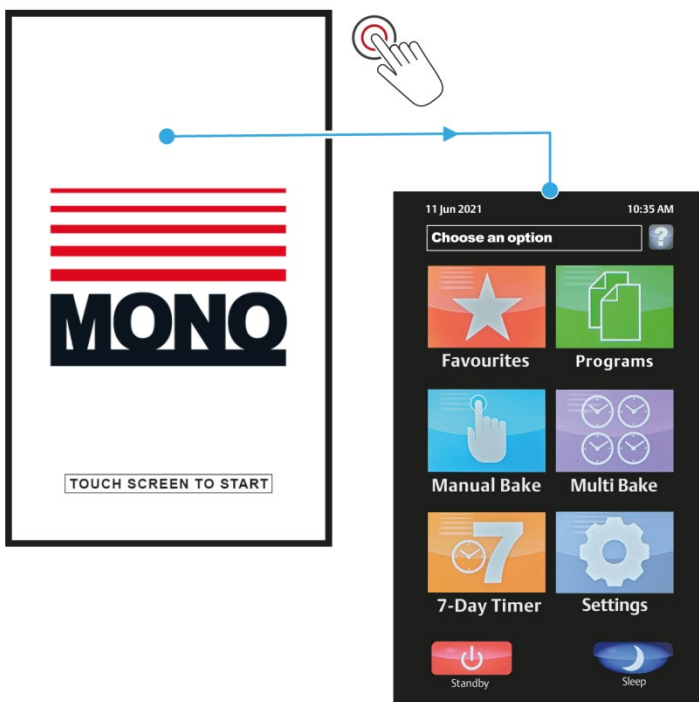

4. Touch the **Programs** tile on the **Choose an option** screen.

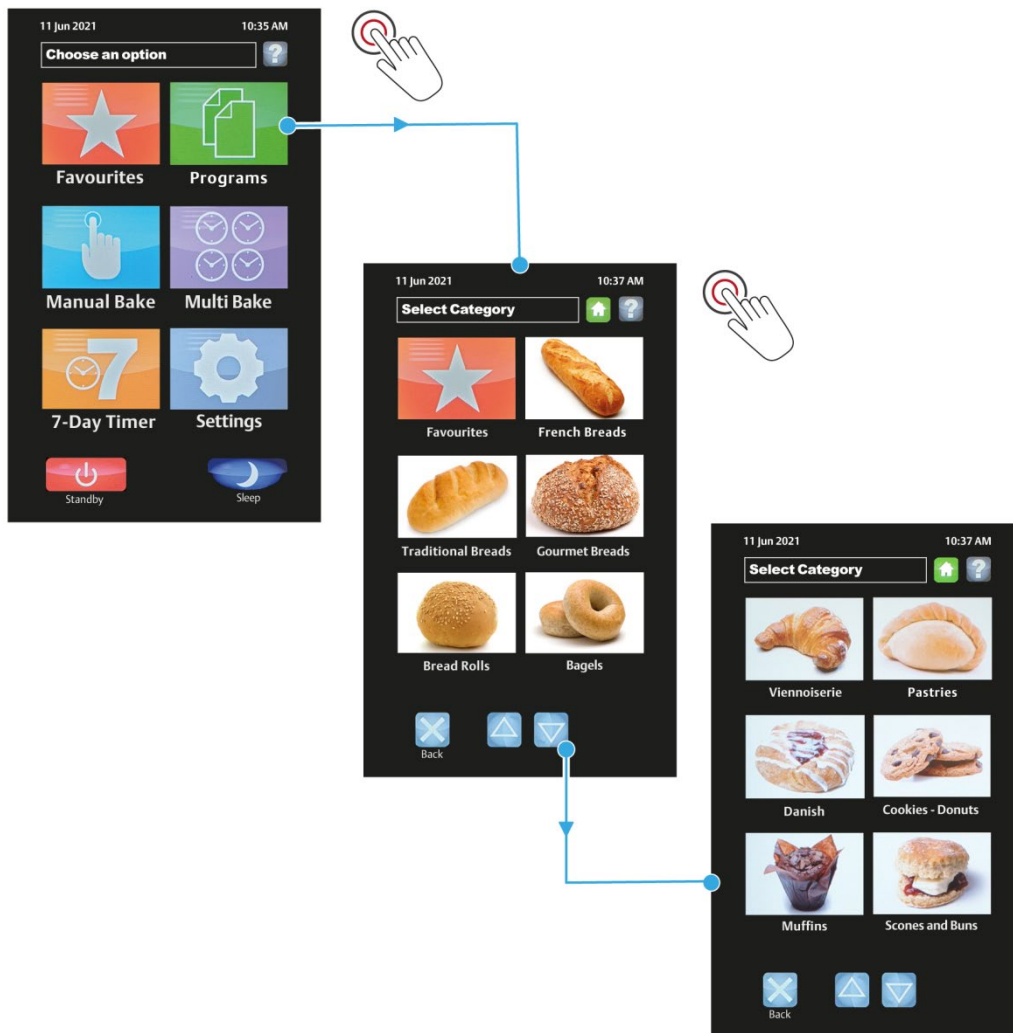

5. Select a product category.
- (a) Touch the scroll up and down buttons to change category pages.
    - The **Back** button returns the display to show the **Choose an option** screen.
  - (b) Touch the tile of a product type you require (e.g., muffins).
    - A list of recipes then displays for that product type.

#### NOTE

Tiles typically show a product group image or a program number group, depending on how the oven was factory configured. See Chapter 7 for how to do updates using the USB flash drive (if supported).

6. Select a baking recipe
- (a) Touch the baking recipe required (e.g., blueberry muffins).
  - (b) If prompted, select **Full Load** or **Half Load** depending on the oven loading.

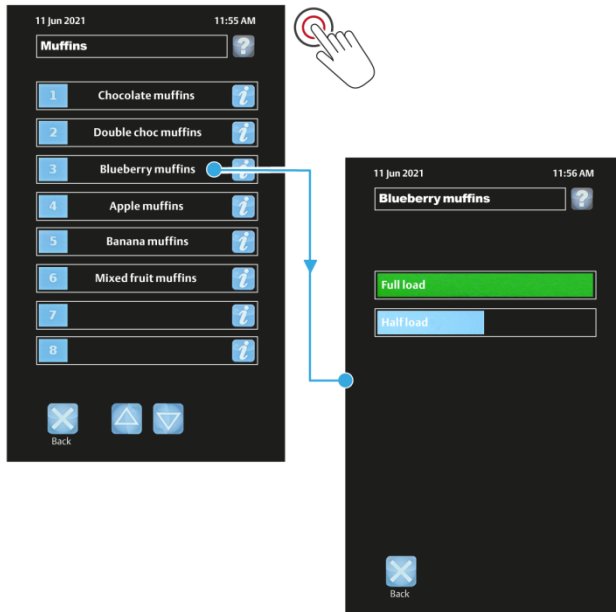

- 7. A baking screen now appears.
  - (a) Wait while the oven heats up. A **Heating** message flashes on the screen.
  - (b) Load the oven with products when **Ready** flashes on the screen.
  - (c) Touch **Start** to begin baking.

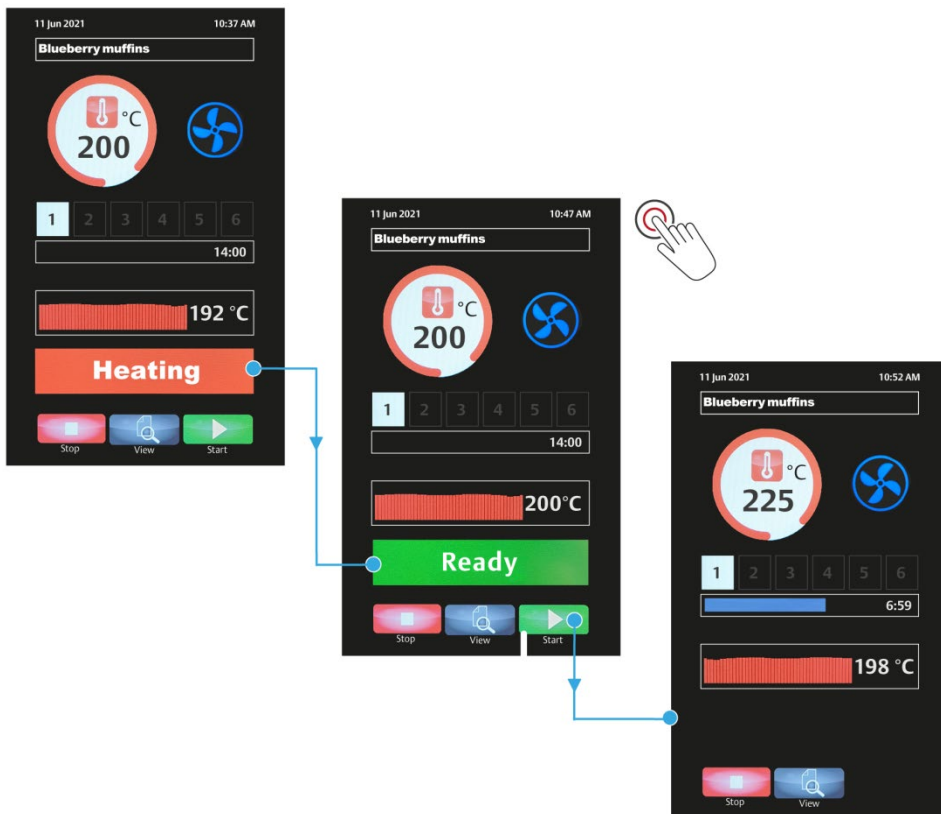

**NOTE**

To maintain the heat in the oven, do not leave the door open for longer than needed. The actual oven temperature fluctuates during a bake – this is normal and not an oven fault.

8. During a bake, two actions can be performed.
  - Touch the **View** button to view settings during a bake.
    - Touch the numbered square (e.g., **2**) to view the settings for different baking phases.
    - The **Cancel** button displays the baking screen again for the present baking phase.
  - Touch the **Stop** button to stop a bake at any time.

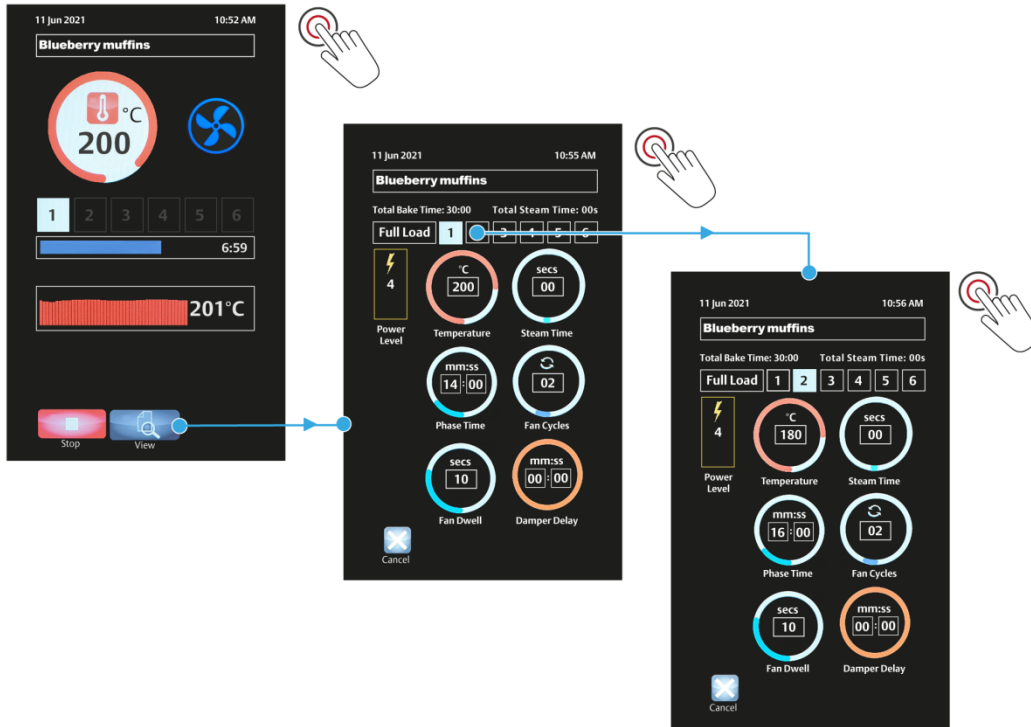

9. When a buzzer sounds to indicate the bake is complete, two actions can be performed:
  - Press the **Stop** button to finish the bake, or
  - Press the **+2 mins** to continue the bake for a further two minutes.
    - This time extension is adjustable in the **Settings** menu.

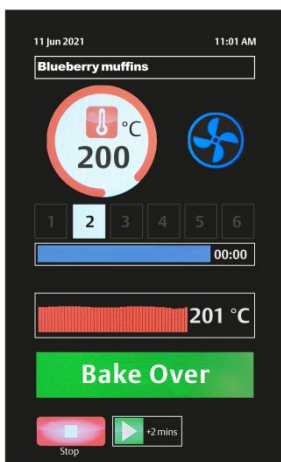

10. Remove the trays and close the door to preserve the heat.



## Manual bake (no program mode)

1. Touch the **Manual Bake** tile.
2. Set the temperature required.
  - (a) Touch the **Temperature** circle.
  - (b) Key in the temperature required.
  - (c) Touch the **OK** (✓) button.



3. Set the baking time required.
  - (a) Touch the **Timer** circle.
  - (b) Use the up and down keys to edit the time.
  - (c) Touch the **OK** (✓) button.



### NOTE

When the time is **00:00**, and the **Start** button is touched, the timer counts upwards until the bake is stopped. If the screen shows **HEATING**, wait until the oven is up to temperature before touching **Start**.

4. Load the oven with products and touch **Start**.

- The timer counts down from a set time to **00:00** or counts upwards if no time set.

5. Use the steam and damper functions when needed.

Button	Function	Purpose of the function
	Steam	After touching <b>Start</b> , touch the <b>Steam</b> button for the number of seconds wanted and release.
	Damper	Touch the <b>Damper</b> button to open the damper, and touch again to close. (The button changes colour when the damper is open).

6. When the timer is counting down and reaches **00:00**, a sounder is heard. A **BAKE OVER** message also flashes on the screen. Touch **Stop** to stop the sounder.

7. The bake can be stopped at any time by touching Stop.

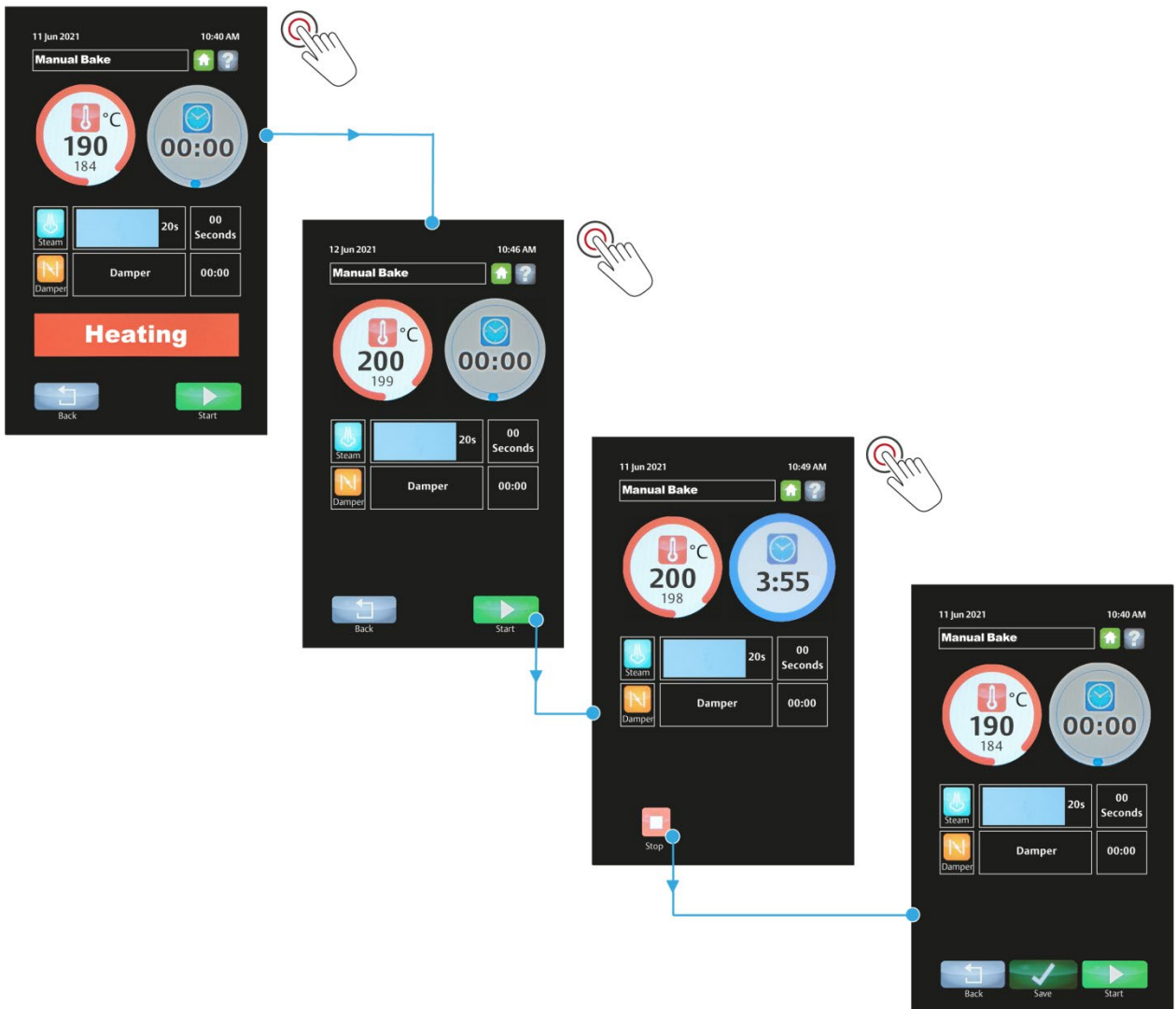

## Setting the time and date

1. Touch the **Settings** tile.
2. Enter the **Oven Settings** password, and then touch the **OK** (✓) button.



---

### NOTE

Default passwords for the various access levels are in the Passwords section of this manual. However, for security reasons, the passwords section may have been removed.

---

3. Touch the **Time & Date** box.

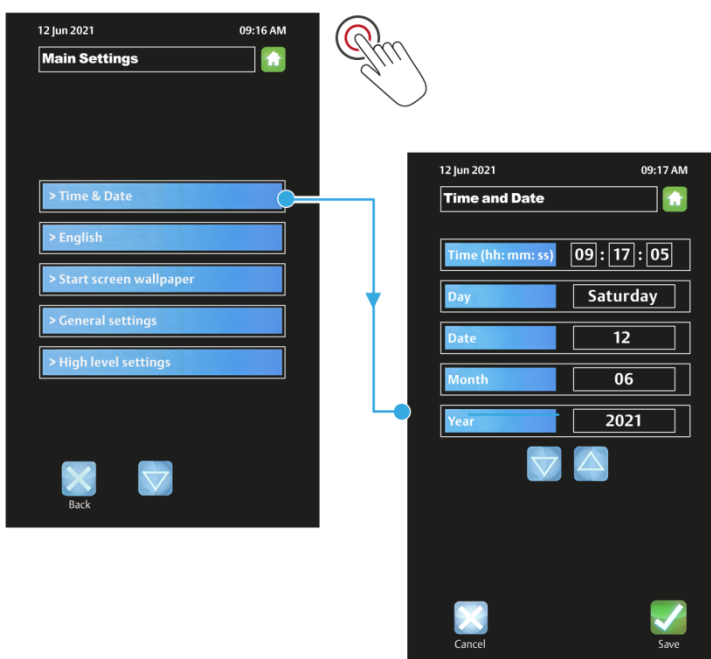

4. Touch the item that needs adjusting, and then use the up or down arrows as required.
  - The time, date, month, and year can be adjusted.
  - The day is not adjustable – it automatically updates using the date, month, and year.



5. Touch **Save** (✓) to confirm new settings.
6. Touch the **Home** button to return to the main screen.

---

**NOTE**

See the **User Settings** section of this manual for complete information about the main oven settings.

---

# Setting up a new program

1. Touch the **Programs** tile.
2. Choose the category or number group required.

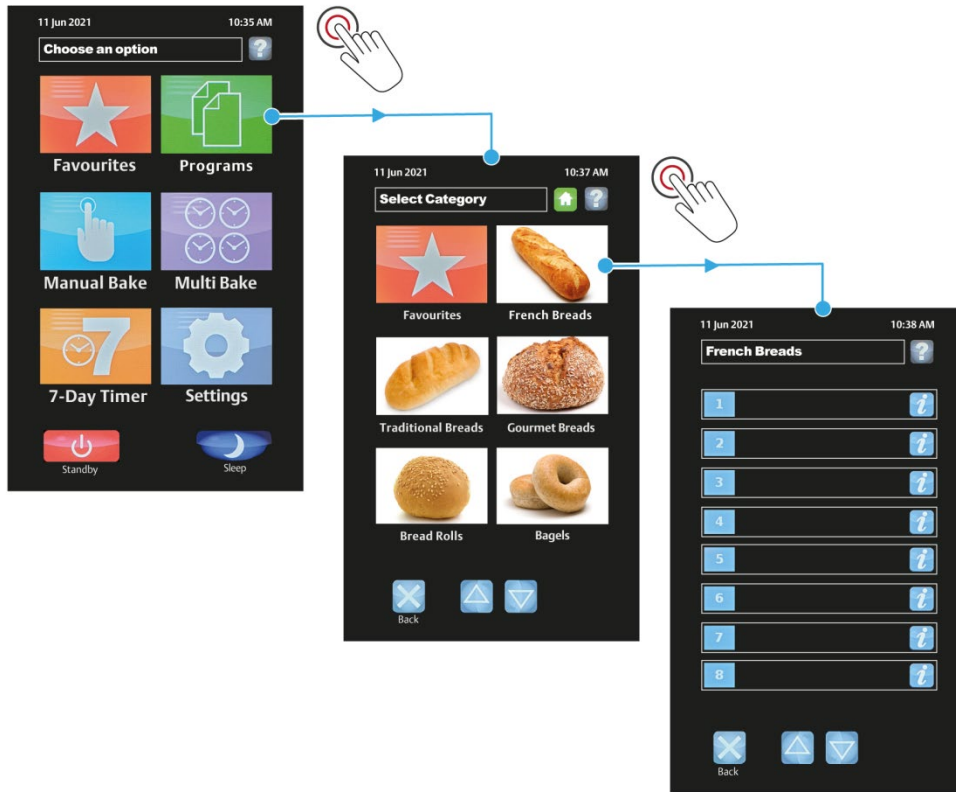

3. Touch the **Info** (i) button of the next free recipe slot.
4. Touch the **Options** button.

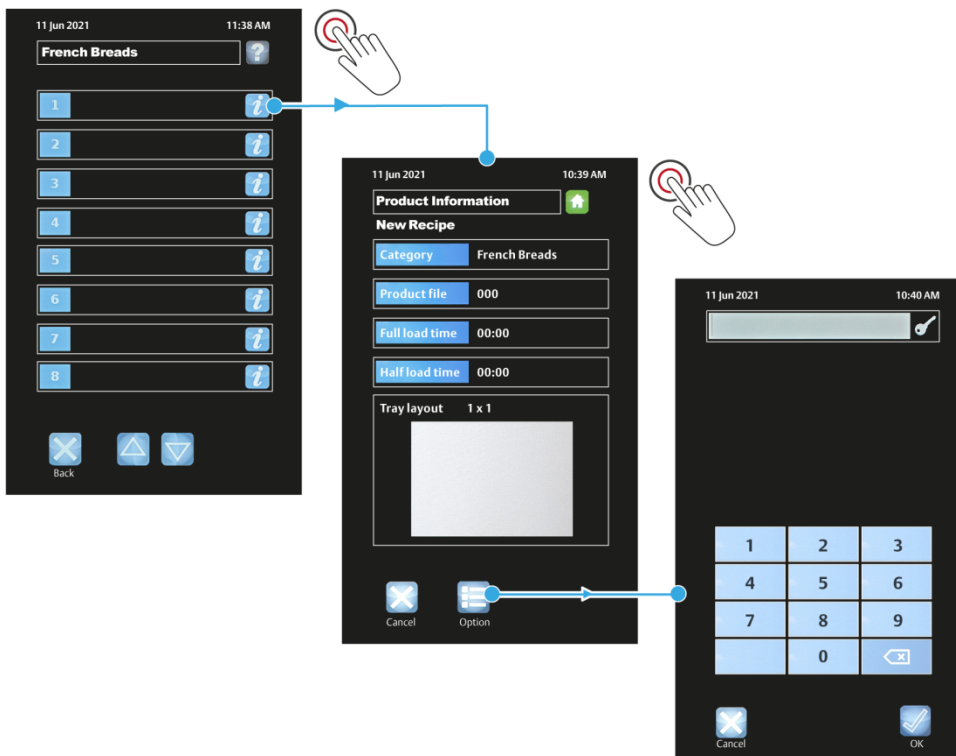

5. Enter the **Operator** password and touch **OK**.

**NOTE**

Default passwords for the various access levels are in the Passwords section of this manual. However, for security reasons, the passwords section may have been removed.

6. Edit a product recipe.

- (a) Choose the **Full-load** or **Half-load** option.
- (b) Select a baking phase number (i.e., **1**).
- (c) Touch an item:
  - Temperature, Steam time, Phase time, Fan cycles, Fan dwell, Damper delay, or Power level.
- (d) Adjust the setting by typing the amount or, if they appear, using the up and down keys.
- (e) Touch **OK** to confirm the setting value.
- (f) Repeat steps (c) to (e) for each item needed in that baking phase.
- (g) If required, select the next baking phase (i.e. touch **2**) and adjust the items in the same way.
- (h) Touch **Save** to confirm the completed recipe settings.

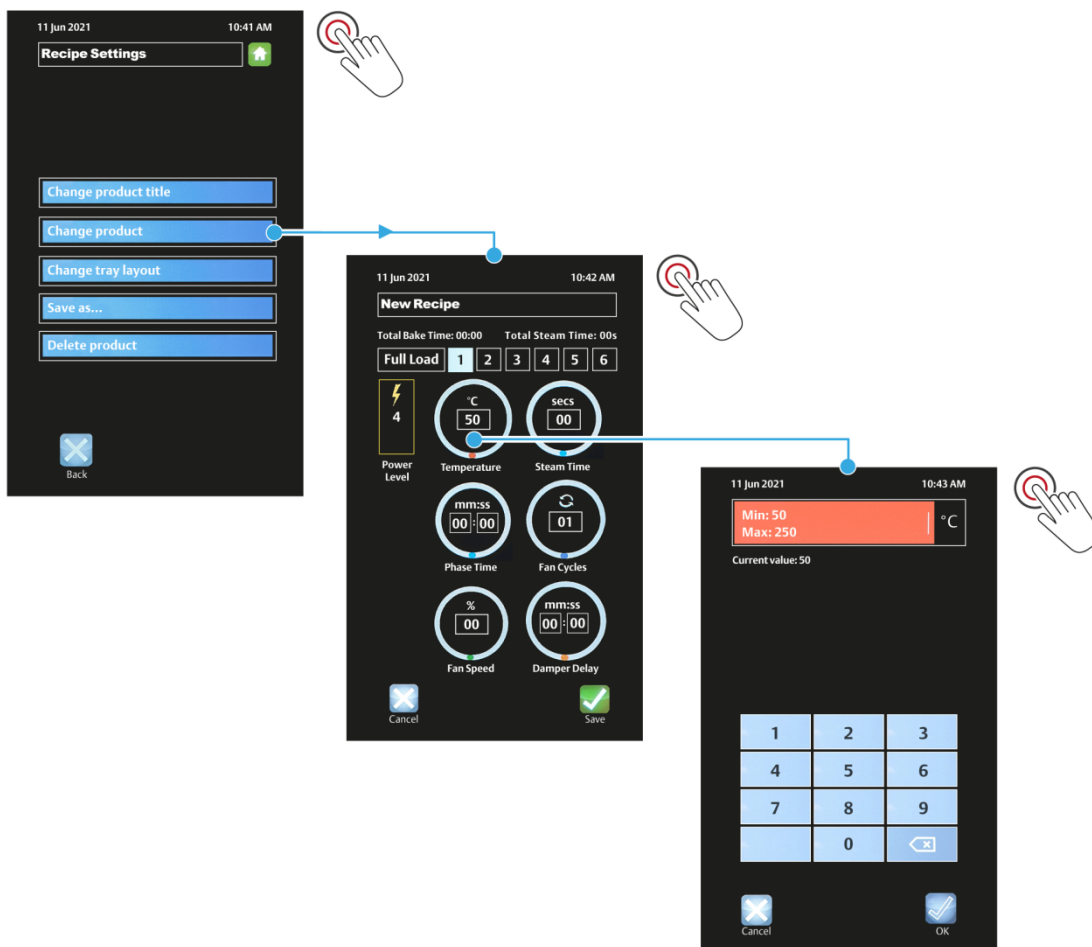

- 7. Edit a tray layout for the new product recipe.
  - (a) Touch the **Change tray layout** box
  - (b) Touch the **W** (width) box to highlight it.
  - (c) Use the up or down arrow key to change quantity across the tray.
  - (d) Touch the **D** (depth) box to highlight it.
  - (e) Use the up or down arrow key to change quantity down the tray.
  - (f) Touch **Save** to confirm the tray layout.

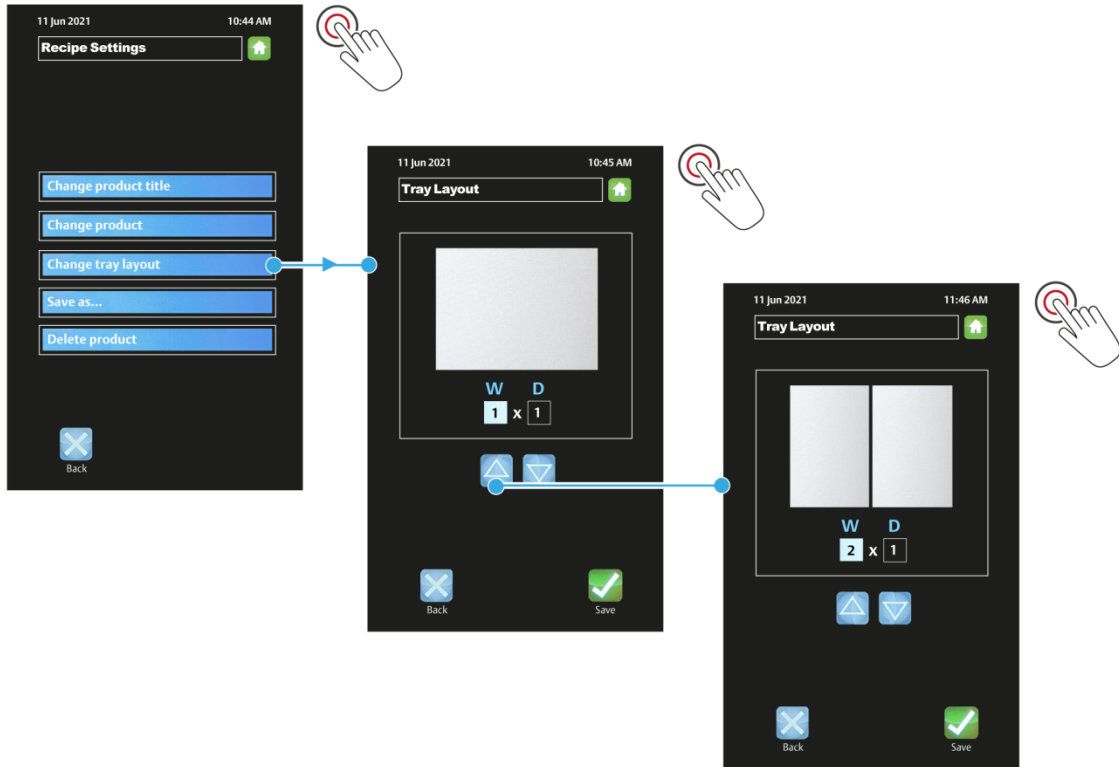

- 8. Add the new product recipe to the list.
  - (a) Touch the **Save as...** box
  - (b) Input a name for the product recipe, and then touch **OK**.

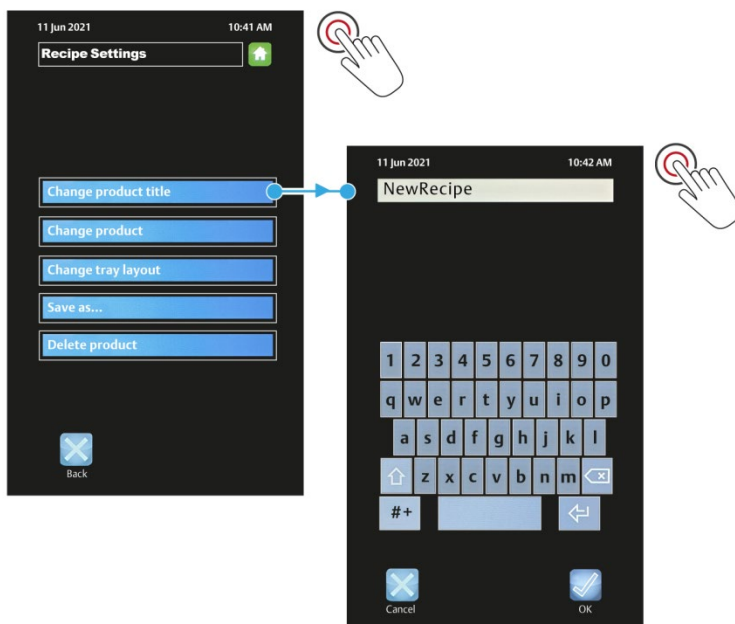

- 9. Touch the **Home** button to finish.

# Multi Bake operation

- 1. Touch the **Multi Bake** tile.

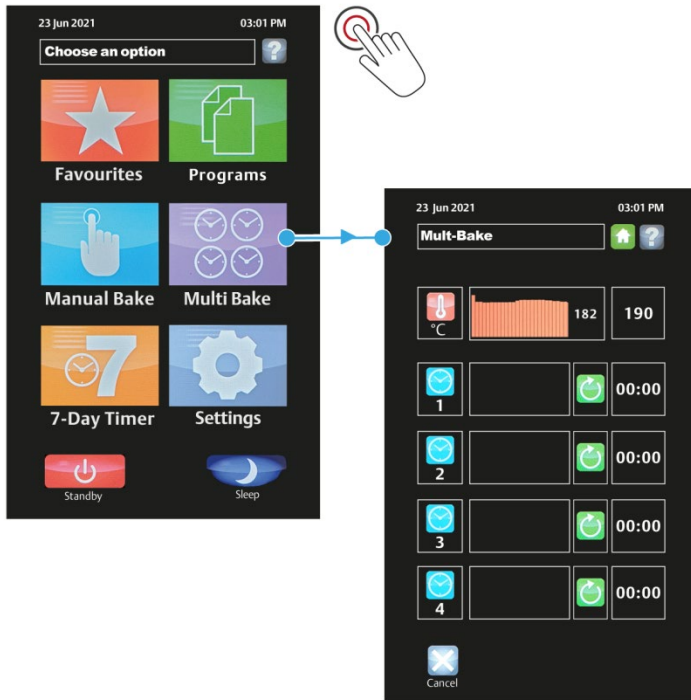

- 2. Set a timer

- (a) Touch a time-setting box.
- (b) Adjust the bake time required using up and down keys.
- (c) Touch the **OK** (✓) button.
- (d) Repeat steps (a) to (c) to set different bake time sequences, if required.

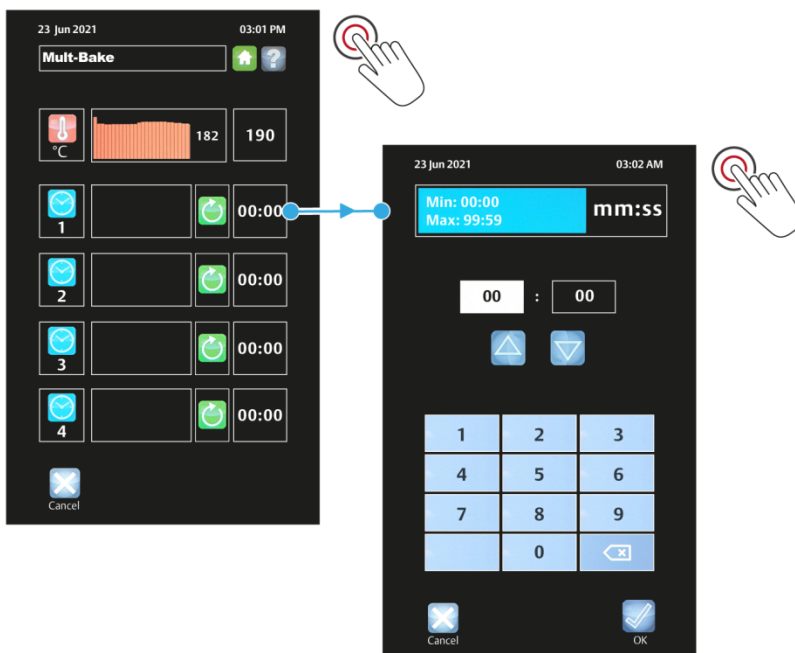



3. Set the temperature for the bakes
  - (a) Touch a heat-setting box.
  - (b) Type in temperature required.
  - (c) Touch **OK** to confirm the temperature.

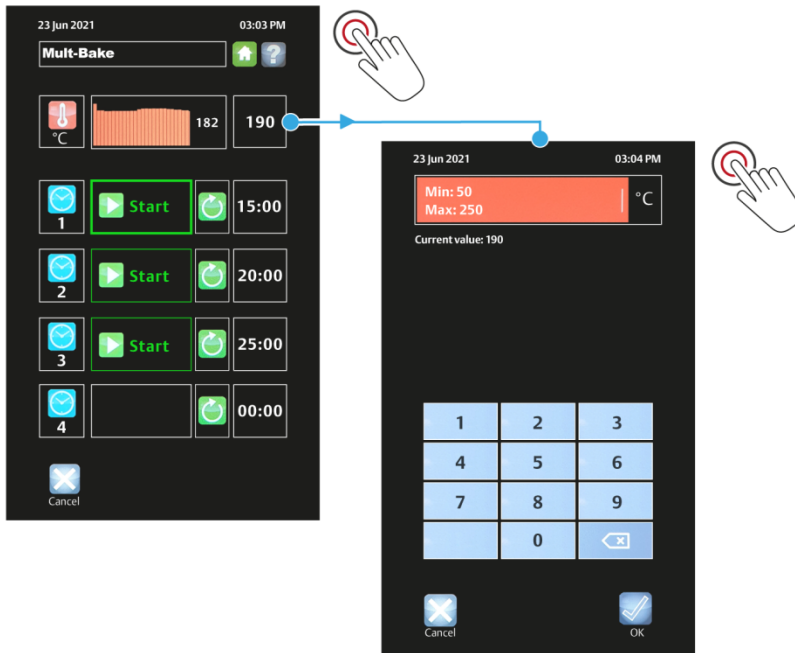

4. Start the bake.
  - (a) Load the oven.
  - (b) Touch the **Start** button (next to the bake time required).

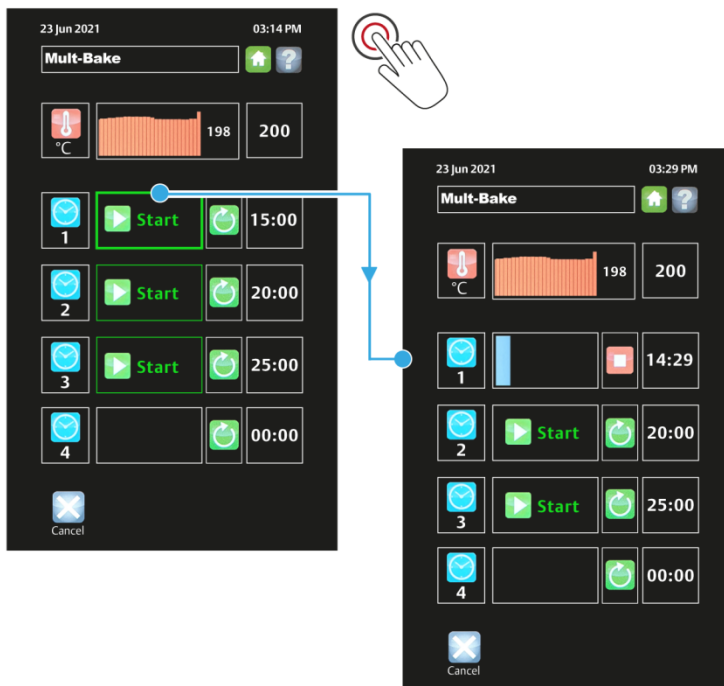

- 9. The panel flashes when a bake finishes, and the oven emits a beep-beep alarm.

Touch the **Stop** button next to the **00:00** time.

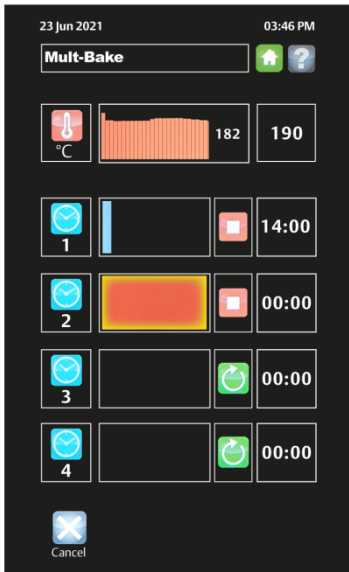

- 10. Touch the **Stop** button at any time to end a bake, and the same settings are useable again.

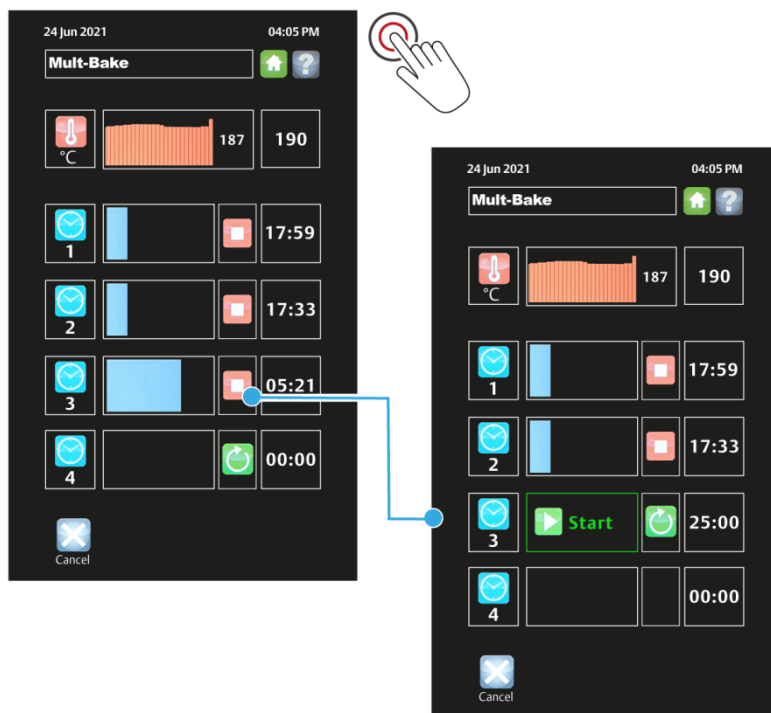

**NOTE**

The settings are reusable until the **Cancel** button is touched. Then, cancelling clears the settings for the next time the Multi-bake function is needed.

# 7-Day Timer

While the oven is in standby mode, it can heat up at pre-set times every day as required.

1. Touch the **7 Day Timer** tile.



2. Touch the day an oven operation is required.
3. Set the **On-time**.
  - (a) Touch the **On** tile of a time panel.
  - (b) Set the time using the keys in the pop-up box that appears, and then touch **Save (A)**.

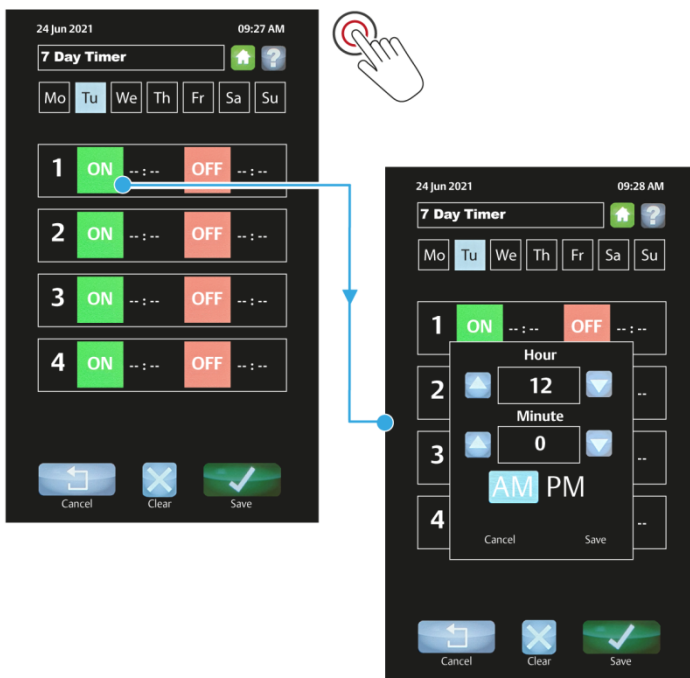

4. Set the **Off-time**.

(a) Touch the **Off** tile of a time panel.

(b) Set the time using the keys in the box that appears, and then touch **Save (A)**.

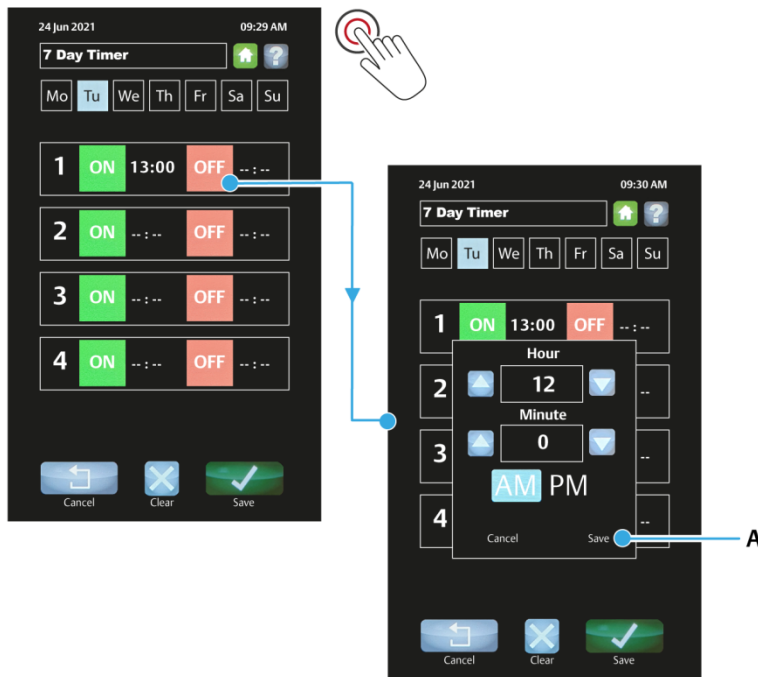

5. Touch **Save (B)** to confirm the 7-day timer settings.

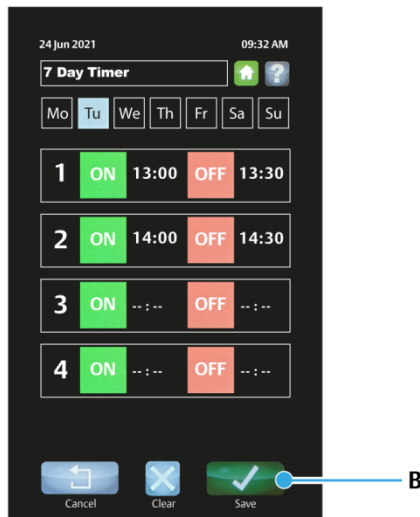

**NOTE**

Remember to leave the oven in **Standby mode** for this 7-day timer function to work.

## Putting the oven into Standby mode

The **Standby** button turns the oven off until the screen is touched again.

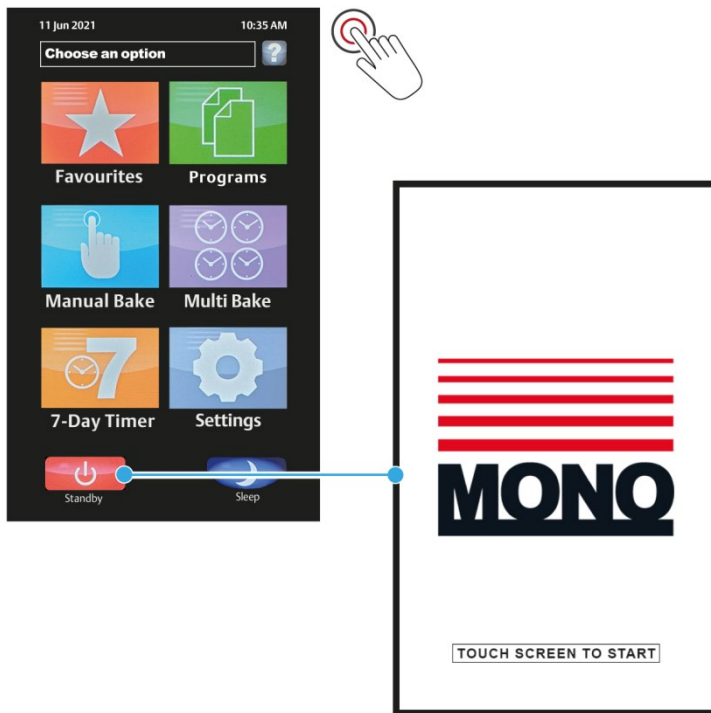

## Putting the oven into Sleep mode

If enabled in the oven settings, the **Sleep** button instructs the oven to maintain temperature to a pre-set value.



## User settings (oven setup)



**CAUTION** ■ Do not change settings unless you are fully aware of the results.

1. Touch the **Settings** tile.
2. Enter the **Oven Settings** password, and then touch **OK**.

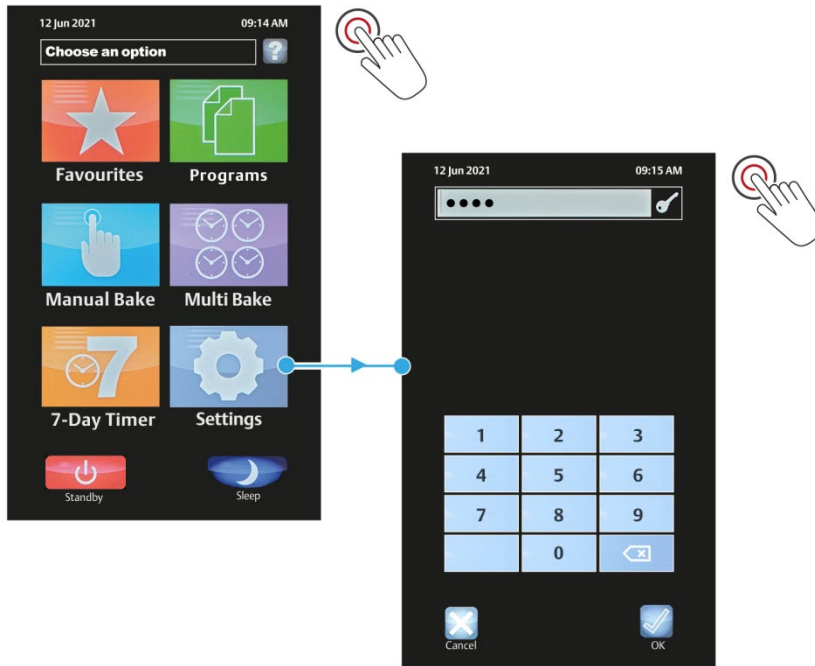

### NOTE

Default passwords for the various access levels are in the **Passwords** section of this manual. However, for security reasons, the passwords section may have been removed.

3. Touch the **General settings** box (A).



4. Touch the **Left Arrow** and **Right Arrow** buttons to access the pages of oven settings.

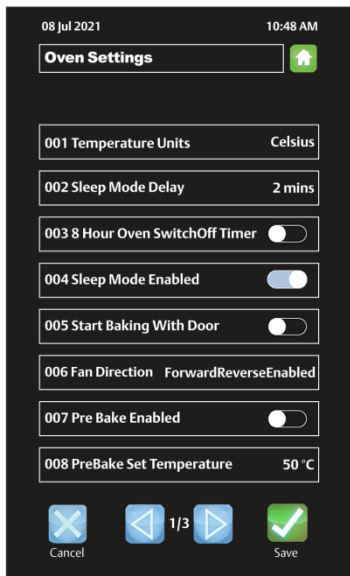

Page 1

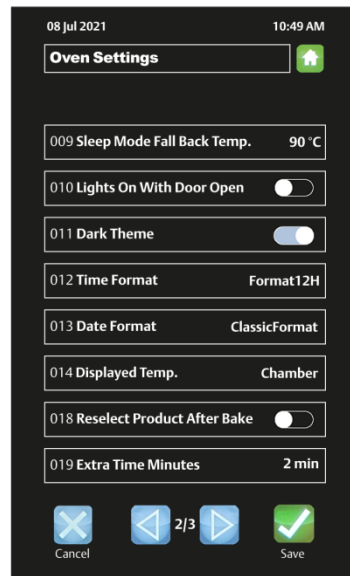

Page 2

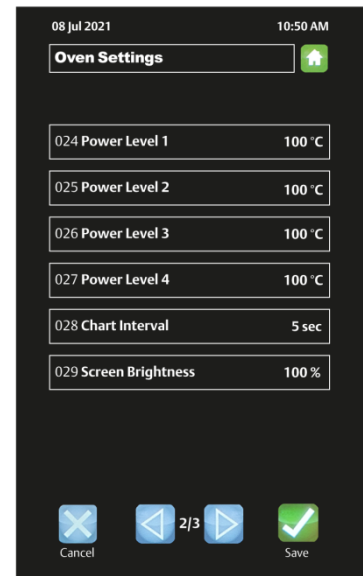

Page 3

5. To make an adjustment, touch the item and change the setting.
6. Touch the **Save** (✓) button when all the oven settings are as required.

**Table 4: Oven settings explained (general level)**

<b>Temperature Units</b>	Centigrade (Celsius) or Fahrenheit.
<b>Sleep Mode Delay</b>	Oven will go into sleep mode after the set minutes, providing it is up to temperature and has been through at least one bake cycle.
<b>8 Hour Switch Off Timer</b>	After 8 hours the oven gives a warning and then turns off. Press any button for an extra hour if required.
<b>Sleep Mode Enabled</b>	Enable or disables the sleep mode button.
<b>Start Baking With Door</b>	This will start the set bake program as soon as the door closes.
<b>Fan Direction</b>	Fan operating modes.
<b>Pre Bake Enabled</b>	Enable or disables heating-up the oven to a preset temperature.
<b>Pre Bake Set Temperature</b>	Preset temperature setting for the pre-bake function.
<b>Sleep Mode Fall Back Temp.</b>	Preset temperature for the oven to maintain whilst in Sleep Mode.
<b>Lights On With Door Open</b>	Option to switch on the oven light whenever the door is opened.
<b>Extra Time Minutes</b>	Adjusts the extra time at the end of a bake for each "extra time" button press. Maximum setting is 10 minutes.
<b>Dark Theme</b>	Colour scheme selection.
<b>Time Format</b>	Preferred format for displaying the time of day.
<b>Date Format</b>	Preferred format for displaying the date, month, and year.
<b>Displayed Temperature</b>	Options to display different temperatures.
<b>Power Level 1 to 4</b>	Set these as required for each level to be used.
<b>Chart Interval</b>	Time interval in seconds that the bars show on the heat and bake time progress charts.
<b>Screen Brightness</b>	Adjusts the brightness of the viewing screen for user comfort



## Factory settings (oven setup)



**CAUTION** ■ Do not change settings unless you are fully aware of the results.

1. Touch the **Settings** tile.
2. Enter the **Oven Settings** password, and then touch **OK**.

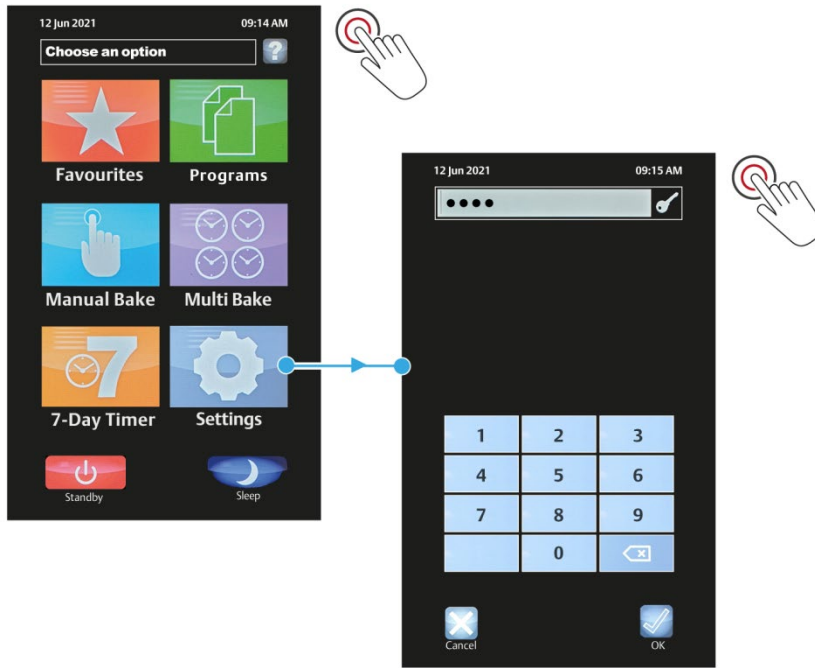

### NOTE

Default passwords for the various access levels are in the **Passwords** section of this manual. However, for security reasons, the passwords section may have been removed.

3. Touch the **High level settings** box (A).



- 4. Enter the **High Level Settings** password, and then touch **OK**.

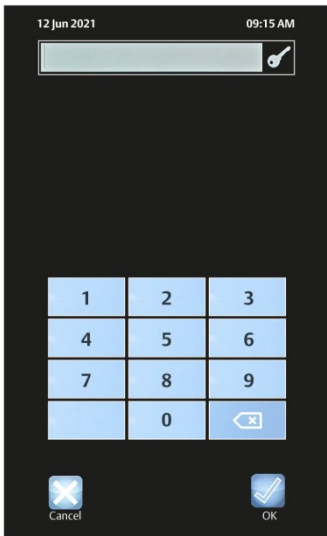

- 5. Touch the **Factory settings** box (B).

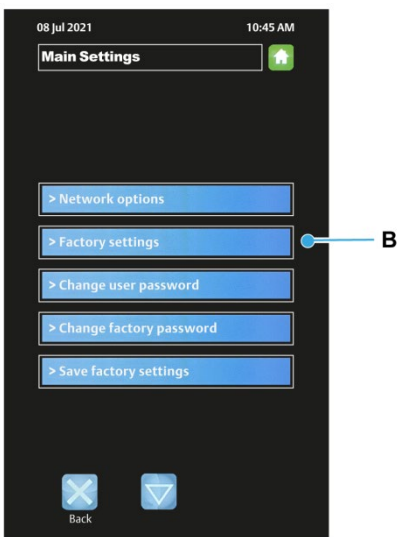

- 6. Touch the **Left Arrow and Right Arrow** buttons to access the pages of oven settings.

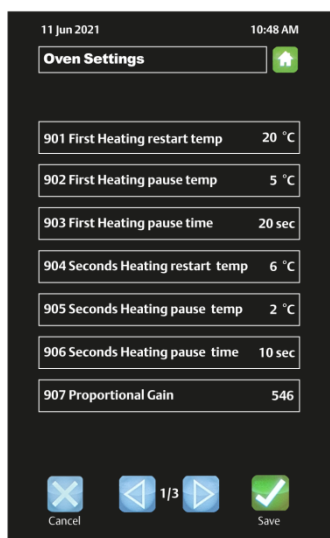

Page 1

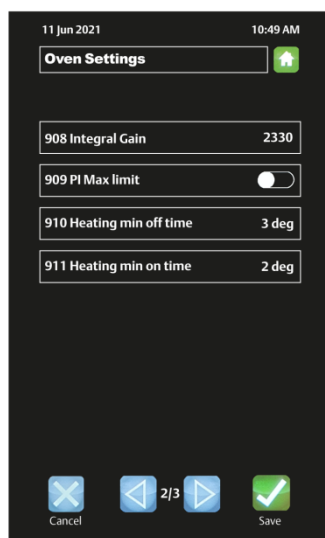

Page 2

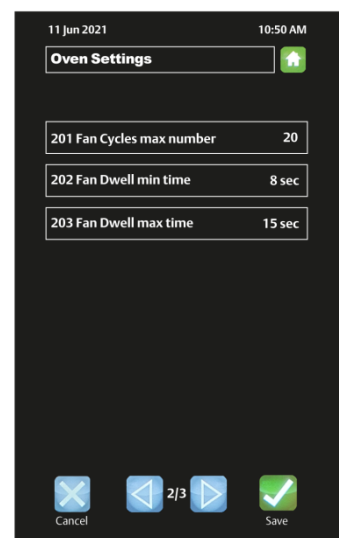

Page 3

- 7. To make an adjustment, touch the item and edit a new setting.
- 8. Touch the **Save** (✓) when the oven settings are as required.

## Changing the passwords

- 1. Touch the **Settings** tile.
- 2. Enter the **Oven Settings** password, and then touch **OK**.



---

### NOTE

Default passwords for the various access levels are in the **Passwords** section of this manual. However, for security reasons, the passwords section may have been removed.

---

- 3. Touch the **High level settings** box (A).



- 4. Enter the **High Level Settings** password, and then touch **OK**.

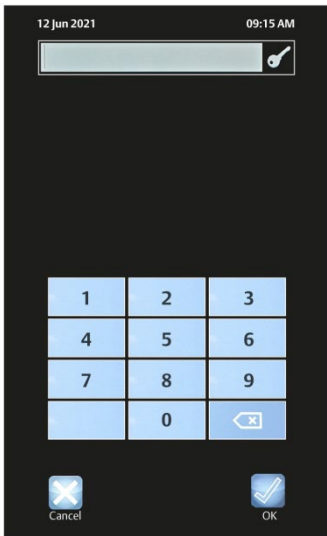

- 5. Touch the password level you want to change (e.g., user password).
- 6. Change the password.
  - (a) Touch the **Old Password** box, and enter the current password.
  - (b) Touch the first **New Password** box (**C**), and enter the new password.
  - (c) Touch the second **New Password** box (**D**), and enter the new password again.
  - (d) Touch the **OK** (✓) button.

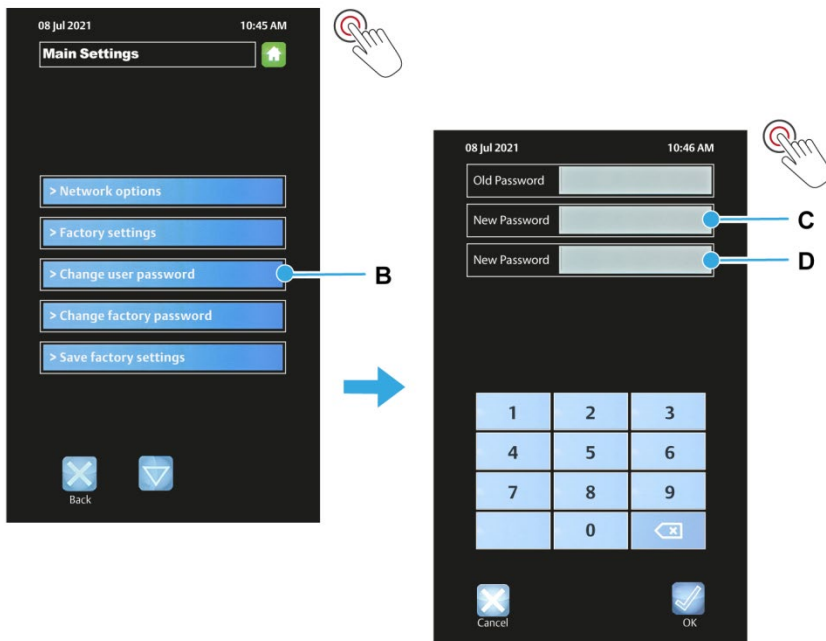

**NOTE**

Make sure you keep a record of the new password.

# Diagnostics

The operation of the following items can be checked from the diagnostics screen:

- Door switch operation
- Fan overload
- Overheat
- Heater
- Fan forward
- Fan reverse
- Steam solenoid
- Damper solenoid
- Lights on/off
- Canopy
- Audio test

## Diagnostics procedure

1. Touch the **Settings** button.
2. Enter the **Oven Settings** password and touch the **OK** (✓) button.



---

### NOTE

Default passwords for the various access levels are in the **Passwords** section. However, for security reasons, the passwords section may have been removed.

---

3. Open the Diagnostic screen
  - (a) Touch the **Settings/Service** panel (A).
  - (b) Touch the **Down Arrow** button until the **Diagnostic** box (B) appears.
  - (c) Touch the **Diagnostics** box (C).
  - (d) Touch **OK** to clear the **Attention** window (D).

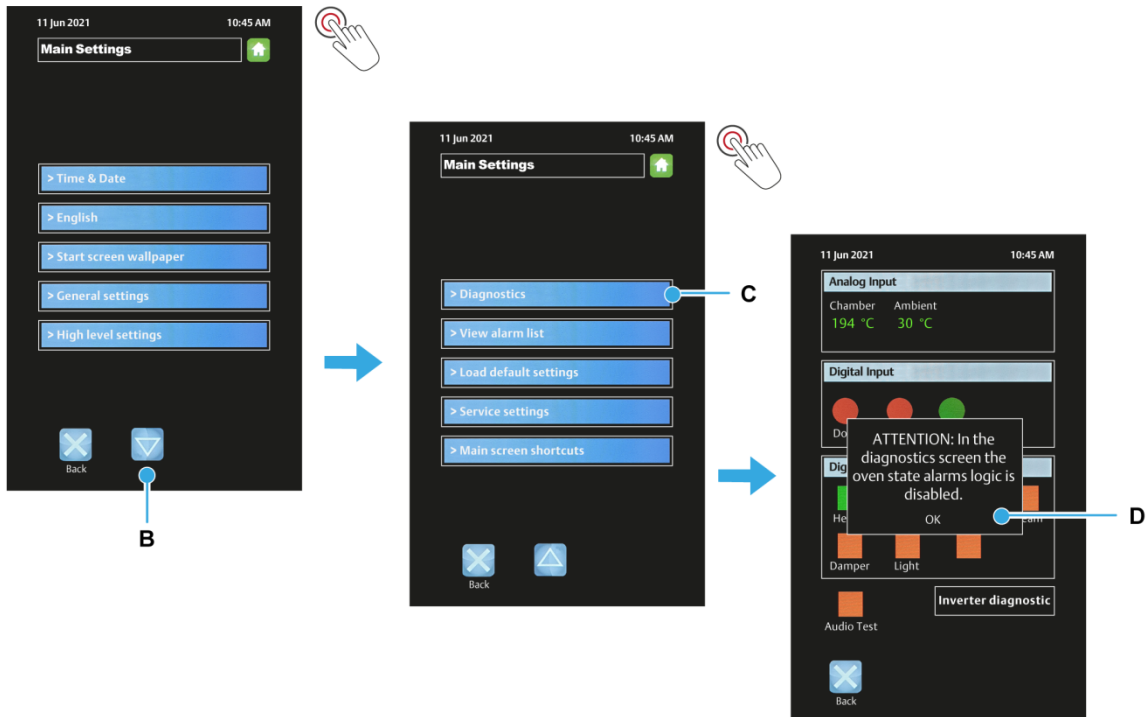

### Using the diagnostics screen

1. Touch the item to be tested (e.g., Light)
  - The red square changes to a green square (E).
2. Touch the same item again to end the test.
  - The green square changes back to a red square.
3. Touch the **Back** button to exit diagnostics mode.



# 7. Using the USB Port

## Using the USB port to import recipes

### Importing a recipe archive to an oven without IoT firmware installed

1. Insert a USB flash drive into the USB socket.
  - Do not force the flash drive into the socket. It only fits one way.
  - A rubber plug may need removal first.



2. Touch the **Settings** button.
3. Enter the **Oven Settings** password and touch the **OK** (✓) button.

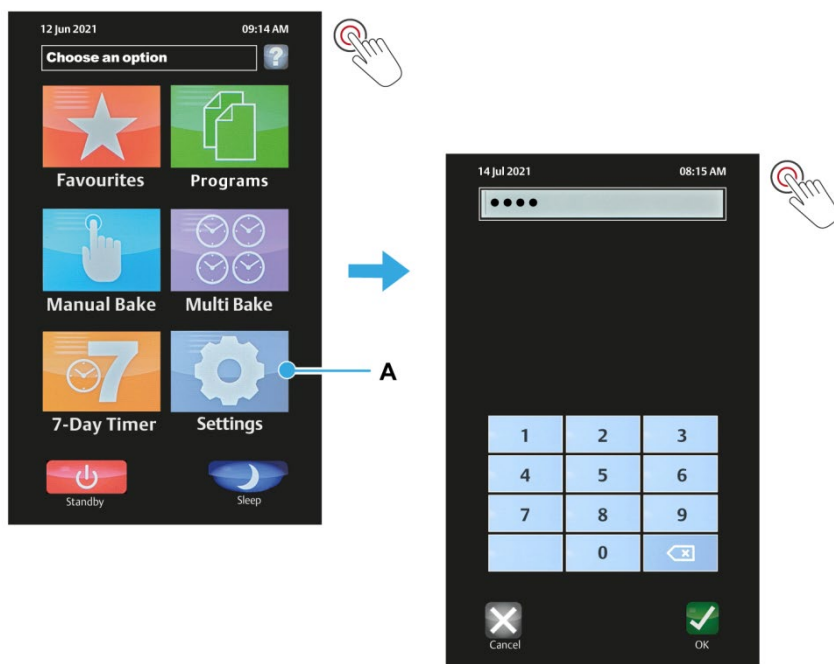

**NOTE**

Default passwords for the various access levels are in the **Passwords** section. However, for security reasons, the passwords section may have been removed.

- 4. Touch the **High Level Settings** box on the main options screen.
- 5. Enter the **High Level Settings** password, and then touch **OK**.

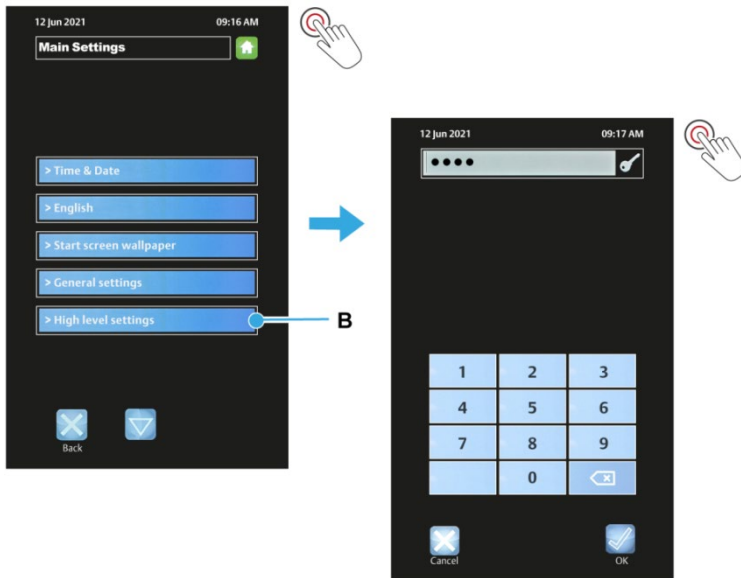

- 6. Touch the **Down Arrow** button (C) to display the next page of high-level settings.
- 7. Touch the **Import recipes from the USB** box (D).
- 8. Touch the **Upload recipe archive from the USB** box (E).

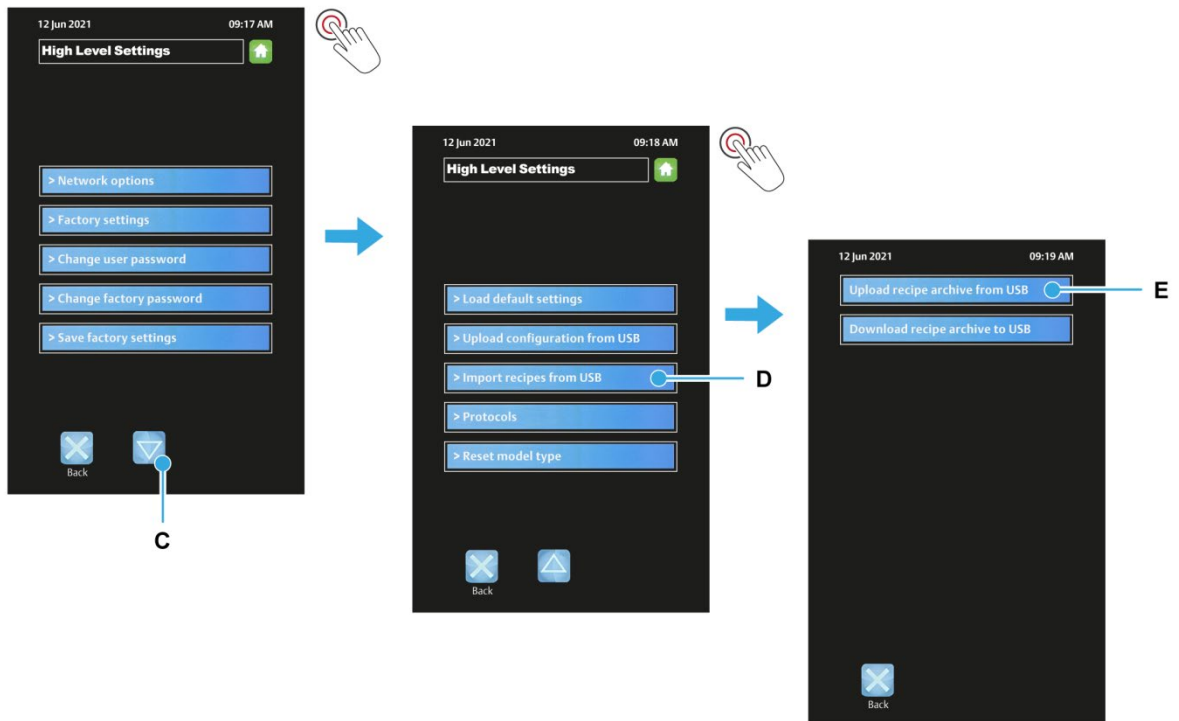



9. Touch the recipe archive required (F), and then touch the **Upload** (✓) button.
10. Touch **Yes** when a pop-up window (G) warns about deleting all current recipes from the oven.
11. Wait for the **Operation Completed** window to be displayed, and then touch **OK** (H).

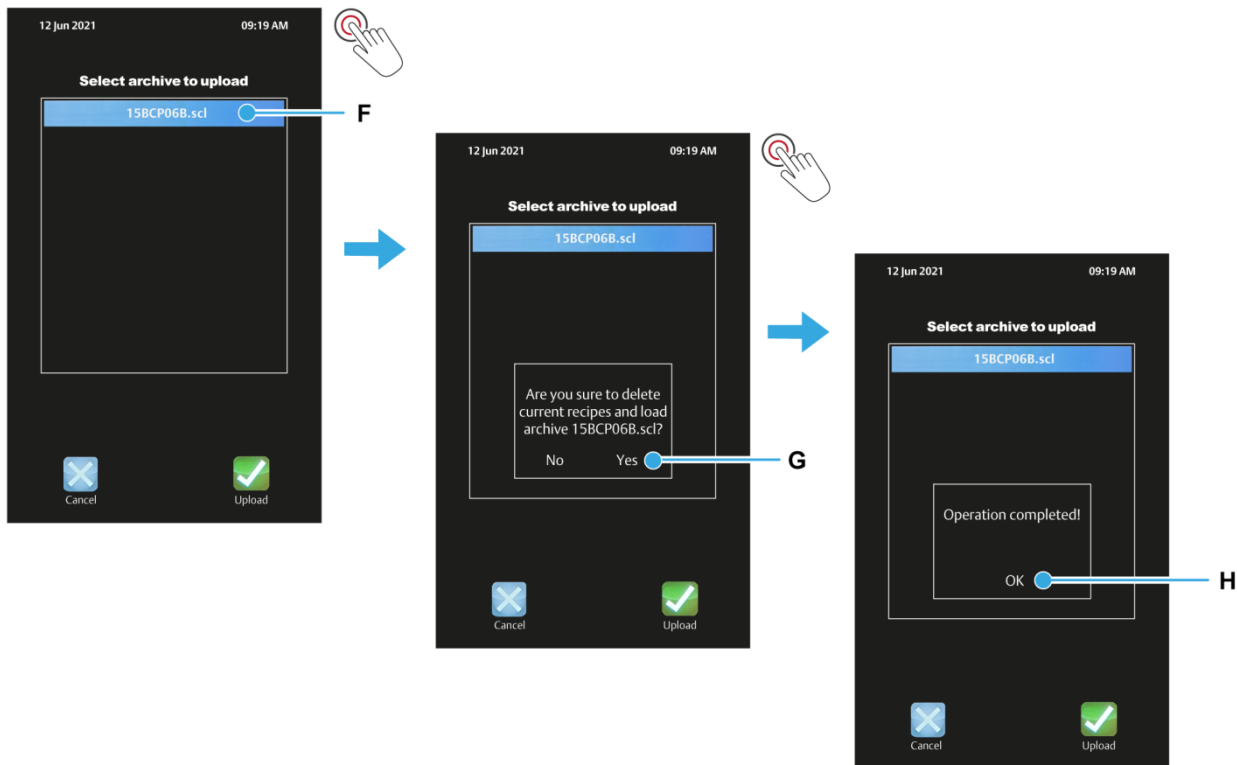

12. Exit by touching the **Cancel** button four times.
13. Remove the USB flash drive from the USB socket.
14. The recipe upload procedure is now complete.

## Importing a recipe archive to an oven with IoT firmware installed

1. Insert a USB flash drive into the USB socket.
  - Do not force the flash drive into the socket. It only fits in one way.
  - A rubber plug may need removal first.



2. Touch the **Settings** button.
3. Enter the **Oven Settings** password and touch the **OK** (✓) button.

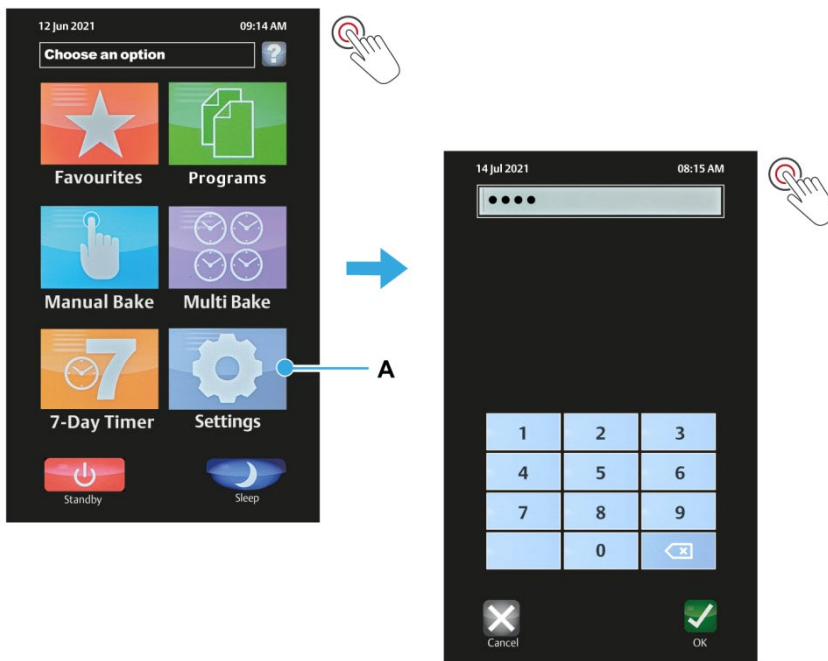

---

### NOTE

Default passwords for the various access levels are in the **Passwords** section. However, for security reasons, the passwords section may have been removed.

---

4. Touch the **High Level Settings** box on the main options screen.
5. Enter the **High Level Settings** password, and then touch **OK**.

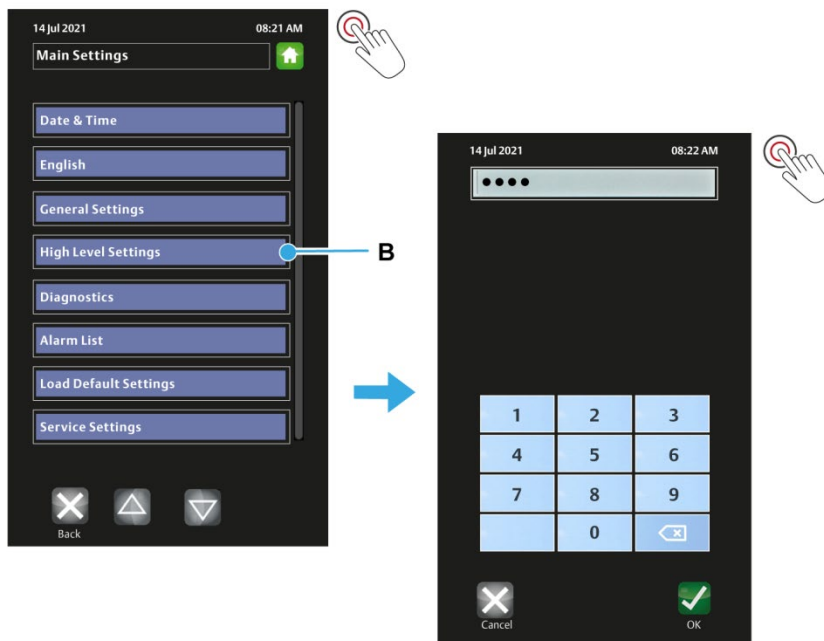

6. Touch the **Import From USB** box (C).
7. Touch the **Upload Recipes** box (D).

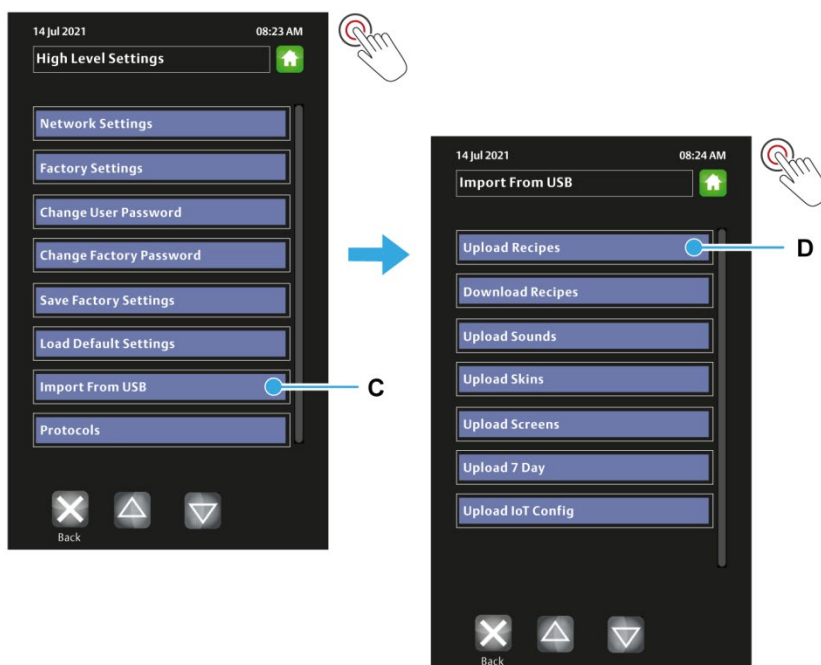

8. Touch the recipe archive required (**E**), and then touch the **Save** (✓) button.
9. Touch **Yes** when a pop-up window (**F**) warns about applying the archive.
  - All current recipes are deleted from the oven and replaced by the uploaded ones.

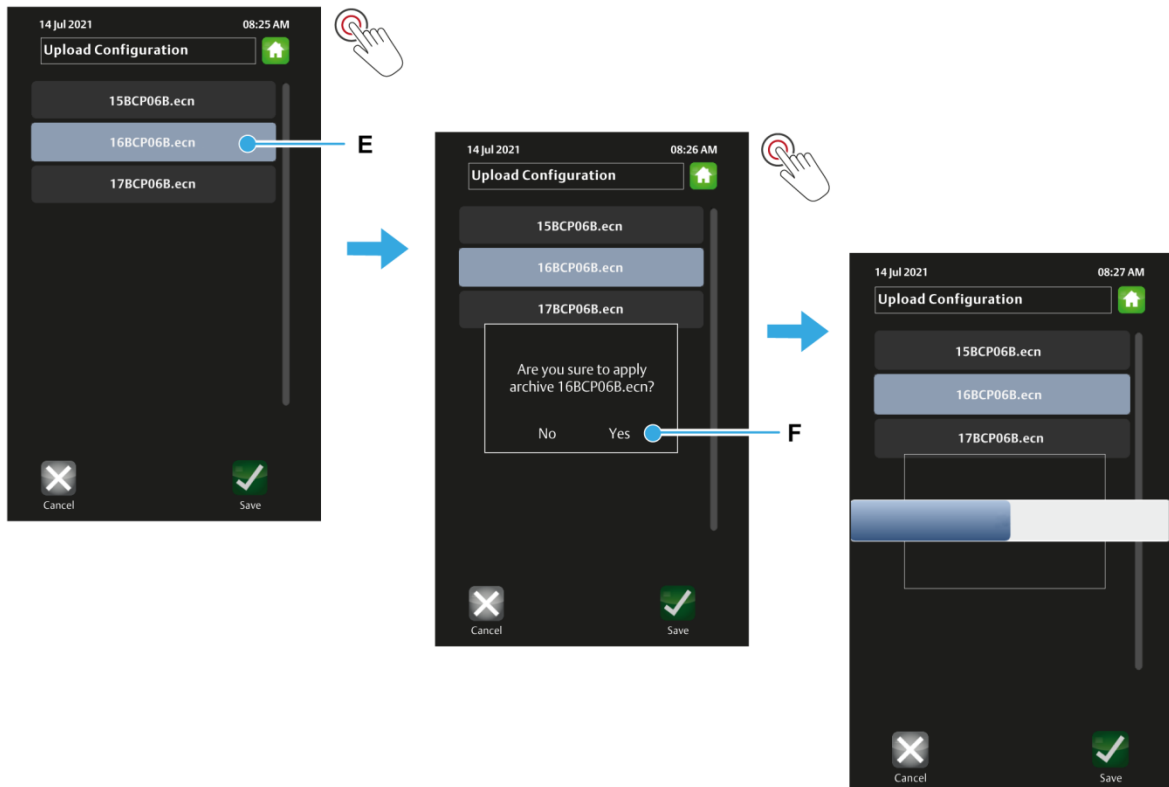

10. Wait for the **Operation Completed** window to be displayed, and then touch the box.
11. Exit by touching the **Home** button.
12. Remove the USB flash drive from the USB socket.
13. The recipe upload procedure is now complete.

## 8. Cleaning

### Cleaning guide for the ECO Convection Oven

Regular cleaning and maintenance of an appliance is essential for optimal performance and longevity. Therefore, it is important to follow a manufacturer's recommended cleaning instructions.

Follow our simple daily and weekly cleaning guidelines to ensure your MONO Convection Oven correctly functions and has durability.

### Safety messages

---

**WARNING**

- Ensure the oven is switched off at the mains power supply and has entirely cooled before undertaking any cleaning tasks.
- Pay particular attention to ensure excess water is not applied around the area of the electrical panels.

**WARNING**

- Do not remove the rear panelling inside the oven. That panel provides access to the fan assembly, which is not safety-interlocked and could cause serious injury.

**CAUTION**

- Clean the oven daily using approved chloride-free cleaning fluid.
  - Take care that water does not enter the control panel or rear-access panel. Never use a pressure washer or water hose to clean the oven.
- 

### Daily cleaning tasks

#### General cleaning

1. Sweep any debris out of the oven **after** it has been allowed to cool.
2. Brush down and wipe the oven front and sides with a damp cloth.
3. Spot clean outside with a damp cloth soaked in a solution of mild detergent and hot water.
4. For stubborn stains, use a proprietary stainless-steel cleaner for the outer surfaces of the oven. A specially designed cleaning agent can dissolve any fat or grease deposits.

#### Checking and cleaning the door seal

The door seal is a crucial part of your convection oven and is prone to wear. Animal fats, grease and caustic cleaning agents attack and weaken the seal material resulting in an accelerated wear rate. A door seal must be cleaned regularly to help prolong its life and maintain its effectiveness.

1. Clean the seal every day using a mild grease solvent.
2. Once clean, use fresh water to remove any remaining cleaning agent.

To help prolong the life of your oven's door seal, we also recommend the following:

- Leave the oven door open overnight to allow the seal to relax.
- Keep the door open when the oven is not in use.
- Regularly inspect the seal for deterioration or damage, and replace it promptly, to prevent the escape of steam/heat from the oven chamber.

## Weekly cleaning tasks

### General cleaning

1. Complete the Daily Cleaning Tasks.
2. Clean any burnt-on debris using a proprietary oven cleaner, carefully following the manufacturer's instructions. Do not allow the oven cleaner to get on the control panel.
3. Use a nylon brush to scrub the cabinet wheels (if fitted) with a solution of mild detergent and hot water.

**Note:** Using too much water eventually rusts the metalwork.

### Glass-door cleaning

The door consists of two parts:

- An outer fixed glass panel
  - An inner glass panel which can be opened for ease of cleaning.
1. Remove the screws shown in **Figure 6**, which allows the inner glass panel to be opened (**Figure 7**).
  2. Clean the door glass with a soft damp cloth. For more stubborn stains, use a proprietary glass cleaner.
    - Do not use scouring agents or anything abrasive, as they can scratch and damage the glass.
  3. Re-secure the inner glass with the screws when finished cleaning.

**Figure 6:** Location of the two screws for releasing the inner glass

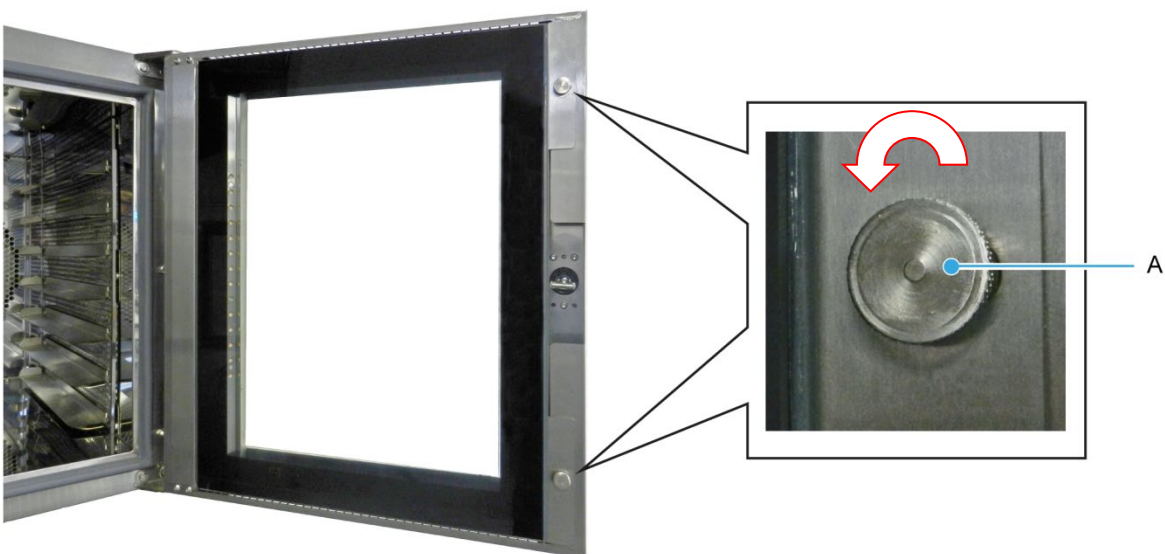



---

**A.** Undo the two screws to release the inner glass for cleaning

---

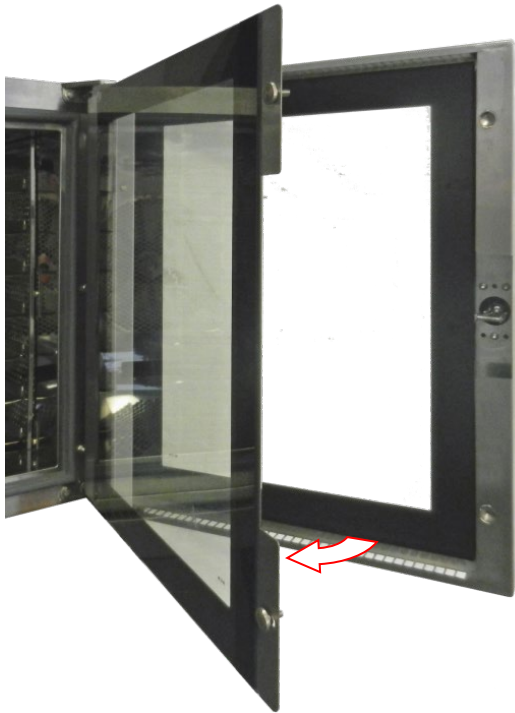
**Figure 7:** Inner glass panel moved away from the door



## Monthly cleaning tasks

### Cleaning the baking chamber

Instructions for models FG134, FG138, FG149, FG150, FG153, FG159, FG170, FG173, FG180, and FG190

1. Remove the fixing screws from the front edge of the perforated side sheets using a flathead screwdriver. Put aside the screws for safekeeping.
2. Pull the perforated side sheets gently towards you and remove them from the oven.
3. Unclip the tray runners from the perforated side sheets for easier cleaning.
4. Clean the oven chamber, the perforated side sheets, and tray runners with a proprietary cleaning agent.
5. Use fresh water to remove any remaining cleaning agent.
6. Replace the perforated side sheets, ensuring the tabs at the back of the sheets insert in the corresponding slots at the back of the oven.
  - Each sheet is marked at the front with either an 'R' (right) or an 'L' (left) to ensure each is refitted to the correct side of the oven.
7. Screw the perforated panels back onto the oven sides and clip the runners back in place.

Instructions for model FG158

1. Lift the tray runner ladders off the locating pins on the base of the oven chamber and tilt the ladders towards the centre of the oven to remove them (**Figure 8**).
2. Clean the oven chamber and the tray runner ladders with a proprietary cleaning agent.
3. Use fresh water to remove any remaining cleaning agent.
4. Replace the tray runner ladders by:
  - (a) angling the base of them to the centre of the oven (**Figure 9 | A**)
  - (b) lifting the top of the ladder onto the ceiling locating pins. (**Figure 9 | A**)
  - (c) Straightening the ladder (**Figure 9 | B**)
  - (d) lowering it onto the locating pins at the base of the oven chamber (**Figure 9 | C**).
3. The tray runner ladders are reversible; they have 4 tray runners on one side and 5 on the other. Make sure, as you replace them in pairs, that they have the same number of tray runners on the left and right-hand sides of the oven (**Figure 10**).

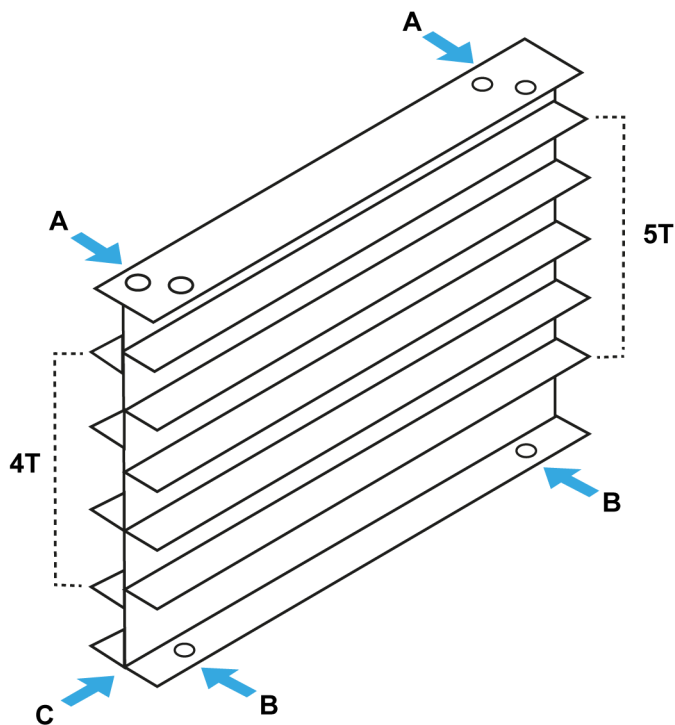
**Figure 8: Removing and installing a runner rack**

---

**A.** Top pin slots

**B.** Bottom pin slots

**C.** Instructions in **Figure 9** are viewed from this direction and show the left-hand rack.

**4T** = 4-trays side

**5T** = 5-trays side

---

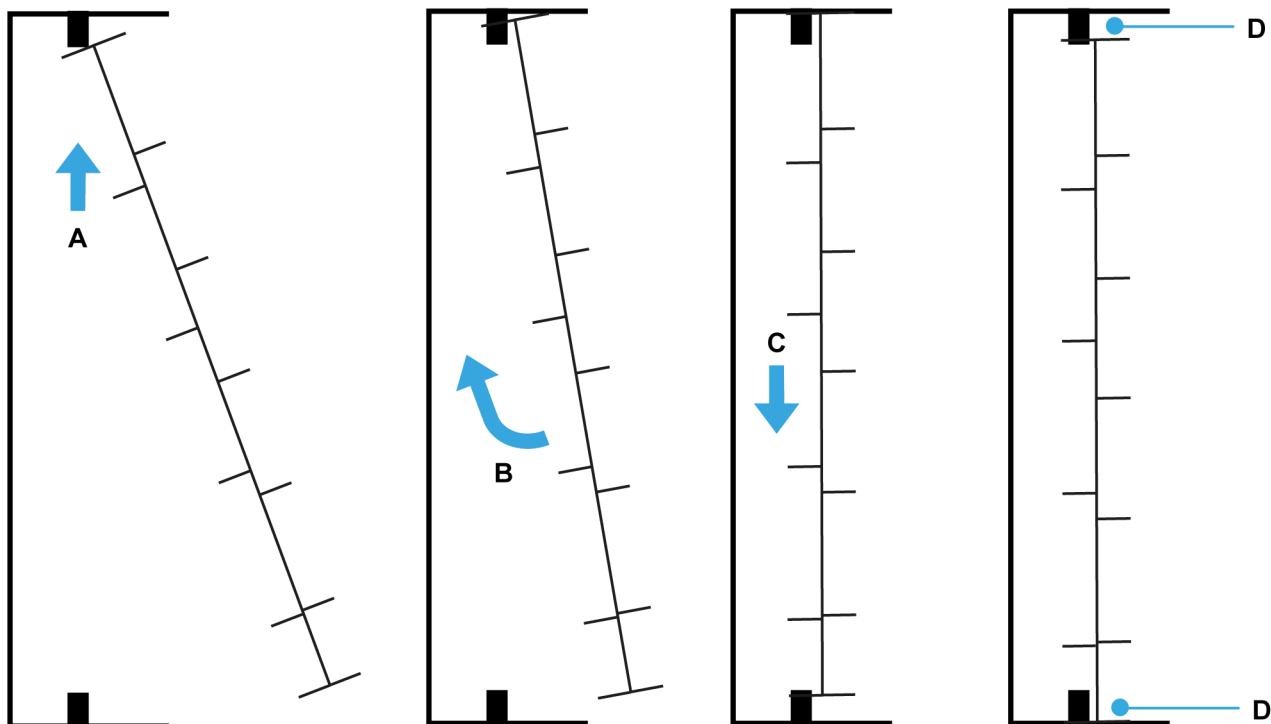

**Figure 9: Installing a runner rack (left-hand side shown)**

- 
- A.** Place slots nearest oven wall over top pins
  - B.** Swing rack to line up bottom slots with the bottom pins
  - C.** Lower rack onto bottom pins
  - D.** Rack held in place by the top and bottom pins
-

**Figure 10:** Check for the correct number of runners on the left and right sides

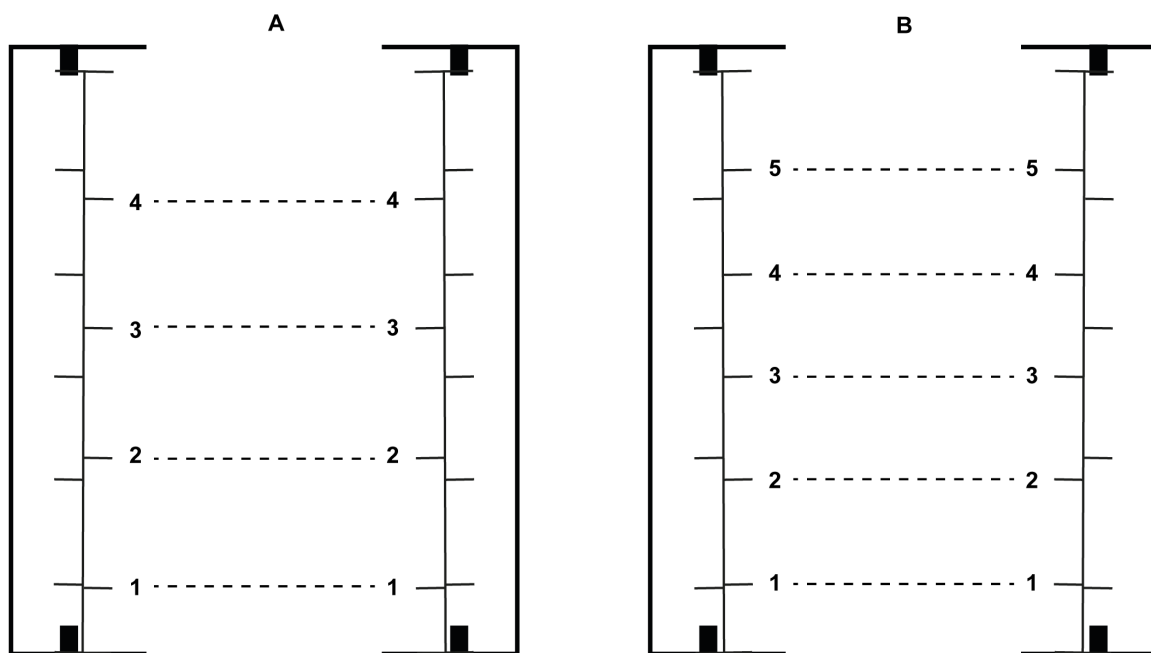

---

**A.** 4-tray runners

**B.** 5-tray runners

---

# 9. Maintenance

## General maintenance

**WARNING**

- This appliance must be maintained at regular intervals. The frequency of maintenance depends upon your specific use and location. The maximum service interval should be 12 months.
- Service and maintenance should only be undertaken by suitably qualified, trained, and competent engineers.
- You must immediately report any damage or defect arising with the appliance.
- Unsafe equipment is dangerous. Do not use the appliance. Isolate the power supply and contact MONO Equipment or your appointed service agent.

- Check for frayed or bare cables.
  - **Do not** use the machine if frayed or bare cables are visible.
- Follow cleaning instructions (see **Cleaning** on page 52).

## Steam system maintenance

- If it is noticed that the steaming operation has deteriorated, perhaps due to hard water scaling, contact your oven supplier.

## Light bulb replacement

**WARNING**

- Contact your supplier in the event of a light failure.
- There are no customer-replaceable parts.

# 10. Spare Parts

When ordering the spares, contact the Spares Department. Please quote the machine serial number (A) as found on the silver information plate of the machine and on the front cover of this manual.

## MONO Equipment Limited

Queensway, Swansea West Industrial Park, Swansea, SA5 4EB, United Kingdom

E-mail: [spares@monoequip.com](mailto:spares@monoequip.com)

Phone: +44/0 1792 564039

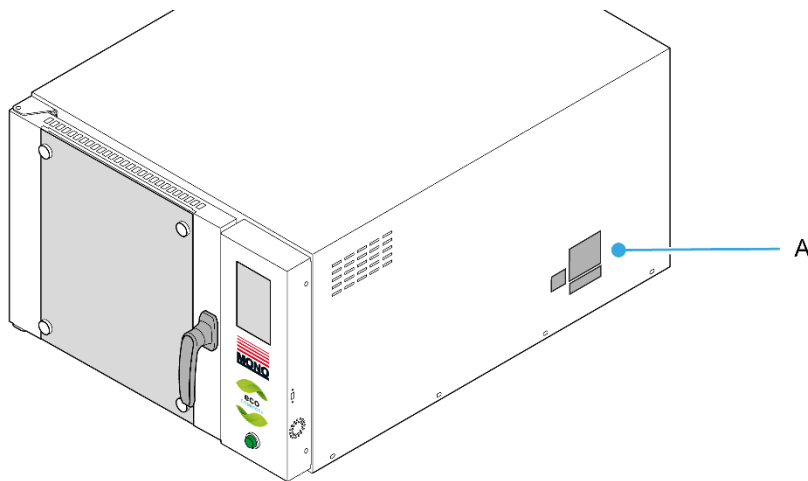

A. Machine serial number

## Index

### PART 1

**FG150      10 Tray Oven Spares Section..... Page 61**

### PART 2

**FG159      4/5 Tray 18" x 30" Oven Spares Section ..... Page 70**

### PART 3

**FG158      4/5 Tray 60cm x 40cm Oven Spares Section..... Page 78**

### PART 4

**FG153      4/5 Tray 40cm x 60cm Oven Spares Section..... Page 86**

**PART 1**

**10 Tray Oven Spares Section**

**Oven Code FG150**

**Figure 11: Rear view with outer sheeting removed (FG150)**

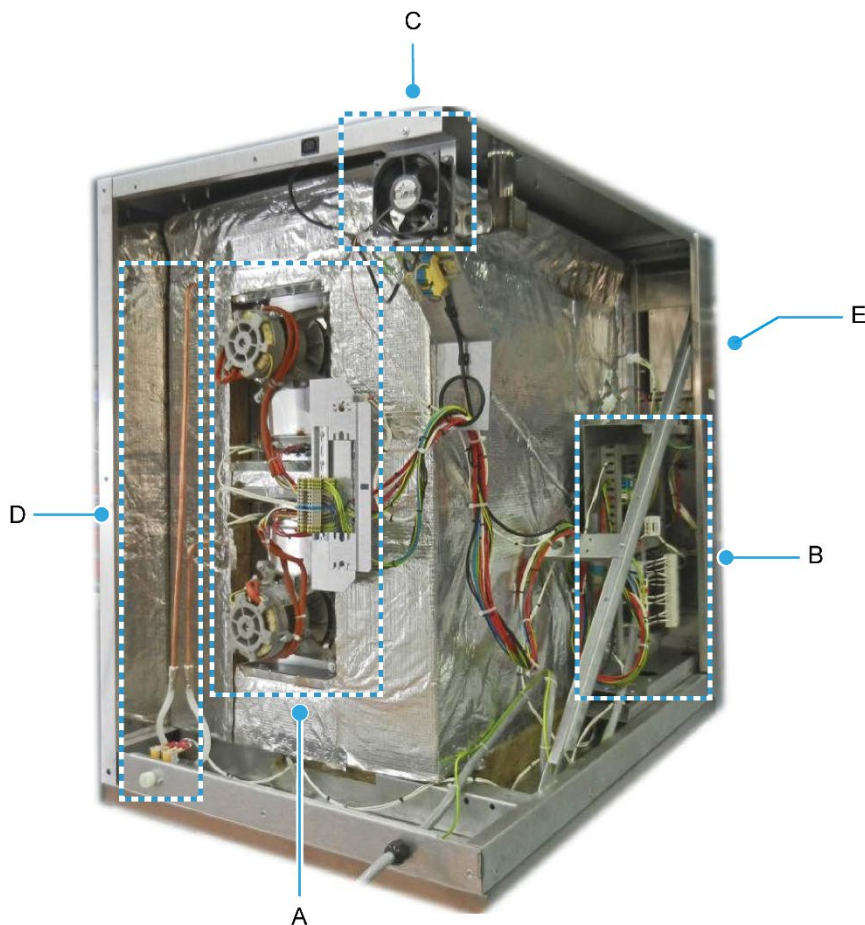

- 
- A.** Motors and Elements ..... (Part 1 / Section 1 on Page 62)
  - B.** Main Panel ..... (Part 1 / Section 2 on Page 64)
  - C.** Cooling Fan and Damper ..... (Part 1 / Section 3 on Page 65)
  - D.** Water System ..... (Part 1 / Section 4 on Page 66)
  - E.** Baking Chamber and Door Parts . (Part 1 / Section 5 on Page 68)
-

# Part 1 | Section 1 | Motors and Elements (FG150)

Figure 12: Motors and Elements (FG150) – 1

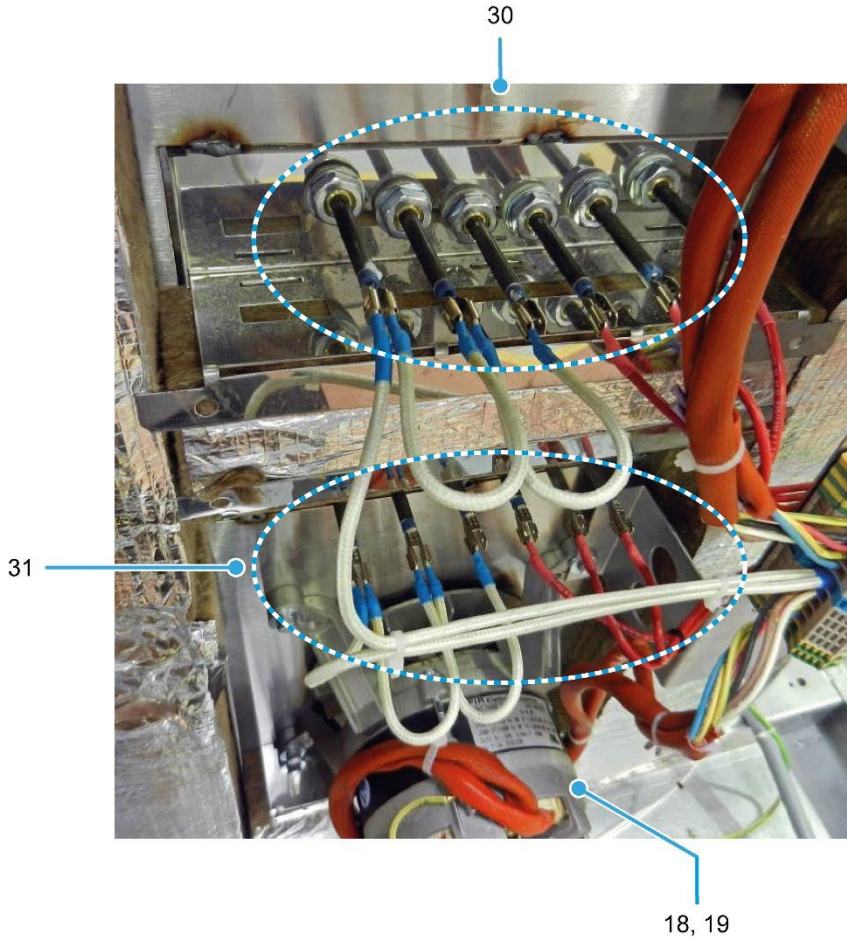

Table 5: Item numbers in Figure 11

Item Number	Part Number	Part Description
18, 19 <sup>(1)</sup>	B720-74-005	Fan motors
30, 31	B847-04-068	Heating element 240 Vac for 8 kW oven
	B847-04-073	Heating element 220 Vac for 8 kW oven
	B847-04-067	Heating element 240 Vac for 7 kW oven
	B847-04-074	Heating element 220 Vac for 7 kW oven

<sup>(1)</sup> Top not shown.

**NOTE**

Part numbers are referenced from electrical drawing M1500E25-75100 in the Electrical Manual.

**Figure 13: 10-Tray Motors and Elements (FG150)**

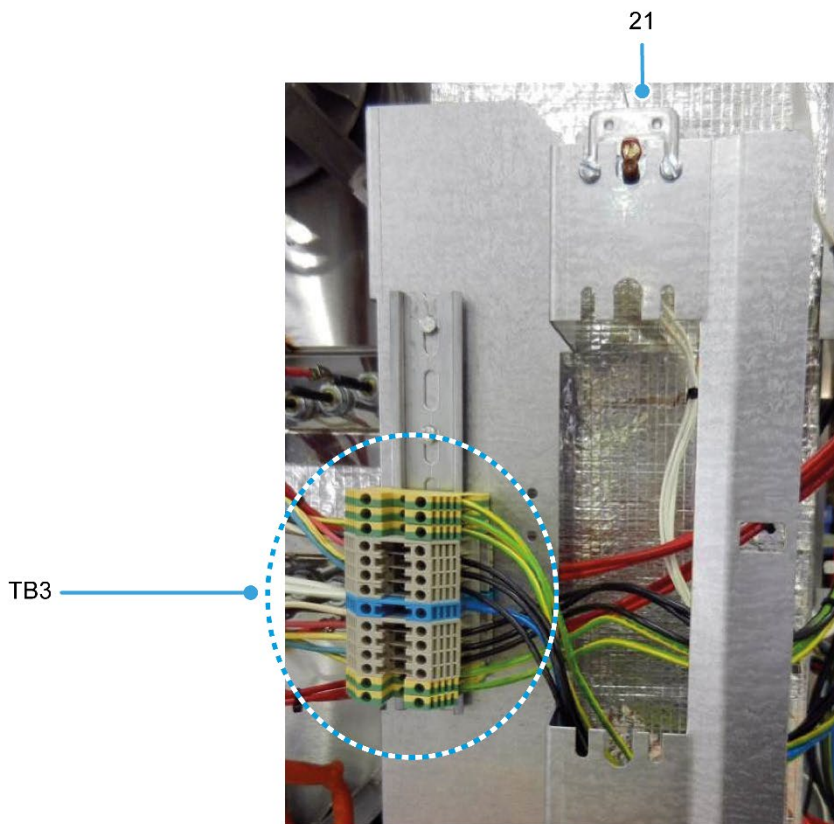

**Table 6: Item numbers in Figure 12**

Item Number	Part Number	Part Description
TB3	N/A	Motor and Element Connections
21	B888-30-014	Overheat thermostat

**NOTE**

Part numbers are referenced from electrical drawing M1500E25-75100 in the Electrical Manual.

# Part 1 | Section 2 | Main Panel (FG150)

Figure 14: Main Panel (FG150)

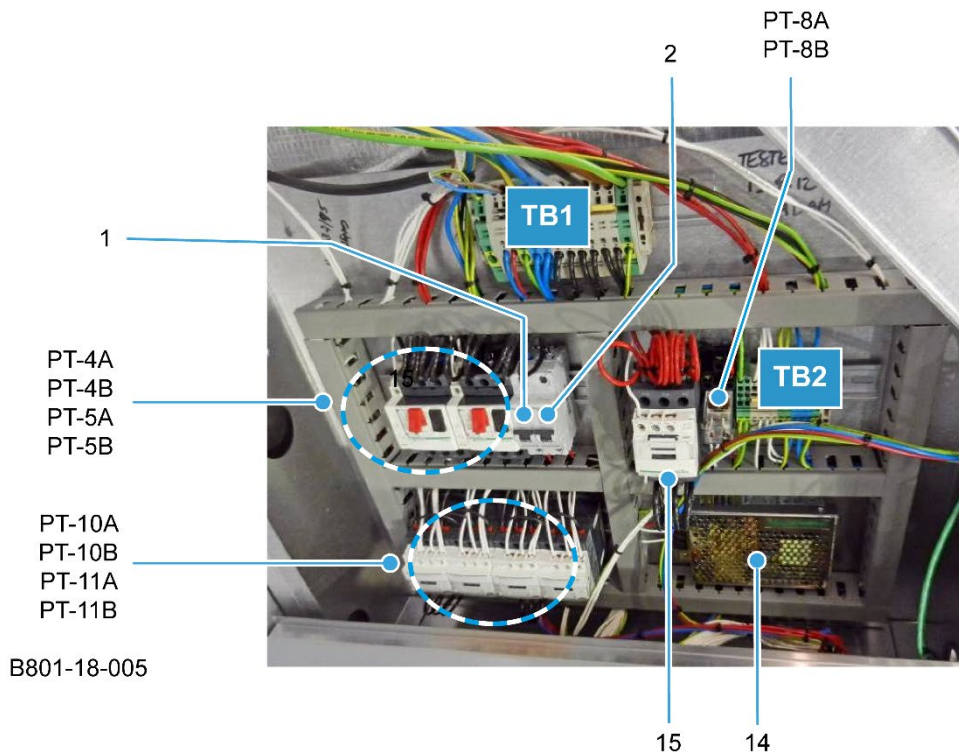

Table 7: Item numbers in Figure 13

Item Number	Part Number	Part Description
1	B872-22-063	Interior lighting MCB
2	B872-22-062	Control cuircuit MCB
14	B801-93-005	24 Vdc power supply unit
15	B801-08-020	Heating element contactor
PT-4A, PT-5A	B801-03-020	Fan motor overload
PT-4B, PT-5B	B801-14-012	Fan motor overload auxiliary contactor
PT-8A	B723-37-004	Interior light relay
PT-9B	B723-36-001	Interior light relay base
PT-10A (Top Forward)	B801-08-031	Fan motor contactors
PT-10B (Top Reverse)		
PT-11A (Bottom Forward)		
PT-11B (Bottom Reverse)		
N/A	B801-18-005	Interlock unit X2

**NOTE**

Part numbers are are referenced from electrical drawing M1500E25-75100 in the Electrical Manual.



## Part 1 | Section 3 | Cooling Fan and Damper (FG150)

Figure 15: Cooling Fan and Damper (FG150)

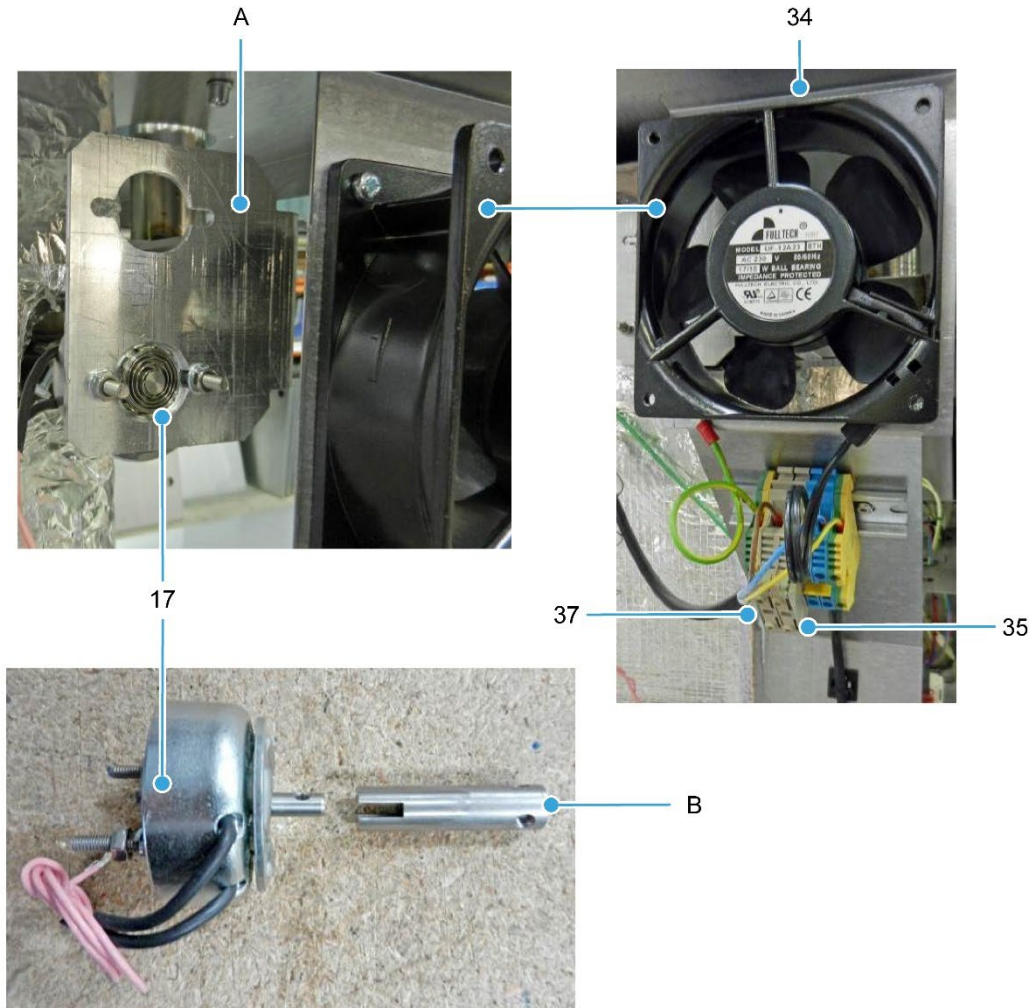

Table 8: Item numbers in Figure 14

Item Number	Part Number	Part Description
17	B749-83-003	Damper solenoid L/H oven
	B749-83-004	Damper solenoid R/H oven
34	B869-75-018	Rear fan unit
35	B842-85-025	Rear fan unit fuse
37	B842-85-039	Auxiliary power outlet fuse
A	150-02-01000	Damper bracket
B	158-02-00600	Coupling

**NOTE**

Part numbers are referenced from electrical drawing M1500E25-75100 in the Electrical Manual.

## Part 1 | Section 4 | Water/Steam System (FG150)

Figure 16: Water/Steam System (FG150) – 1

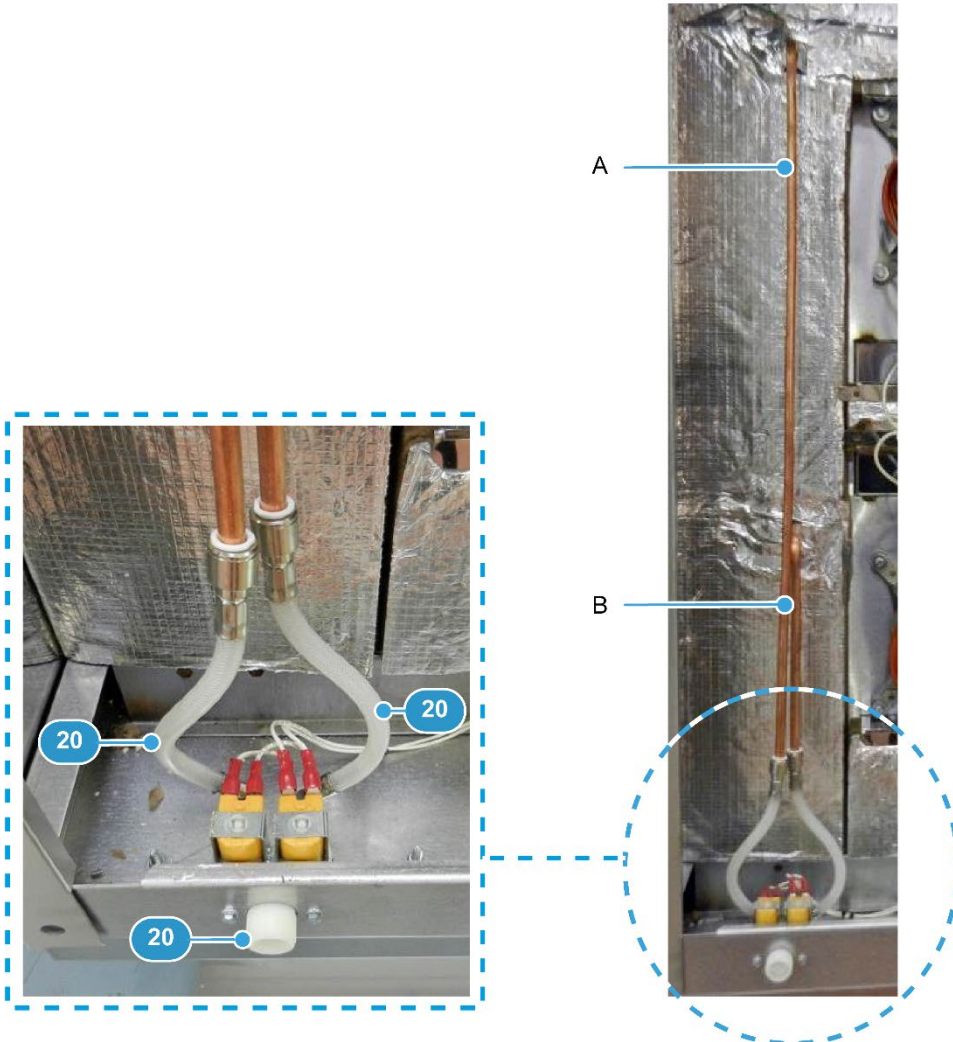

Table 9: Item numbers in Figure 15

Item Number	Part Number	Part Description
20	150-07-00400	Water solenoid (including hoses)
N/A	A900-34-087	Hose – blue (not shown attached)
A	150-07-00800	Delivery pipe – long
B	150-07-00700	Delivery pipe - short

**NOTE**

Part numbers are referenced from electrical drawing M1500E25-75100 in the Electrical Manual.

**Figure 17: Water/Steam System (FG150) – 2**

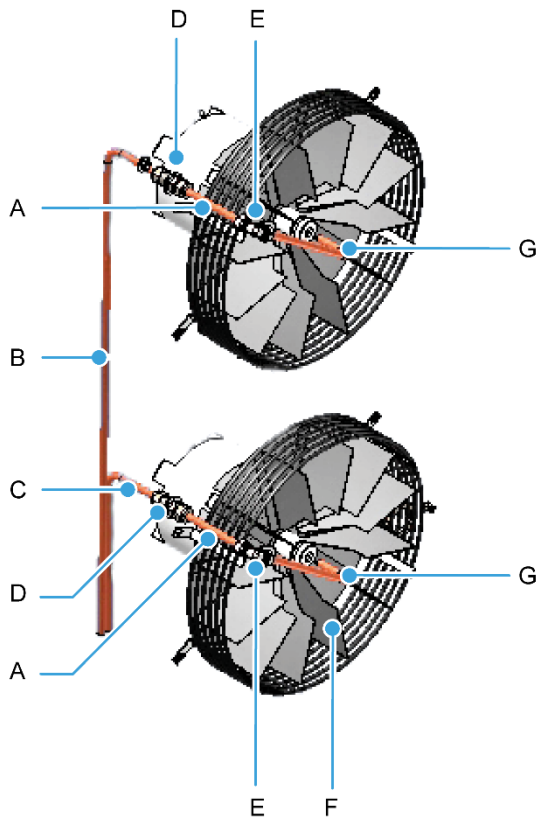

**Table 10: Item numbers in Figure 16**

Item Number	Part Number	Part Description
A	150-07-00900	Joint tube
B	150-07-00800	Delivery pipe - long
C	150-07-00700	Delivery pipe - short
D	A900-34-321	Bulkhead coupling
E	A900-34-387	Equal elbow
F	150-00-11300	Fan
G	150-07-00500	Delivery pipe

**NOTE**

Complete steam assembly kit is part number 150-07-00003.  
Includes 150-01-07700 (pipe guide bracket x 2) and 150-07-00400 (double solenoid inlet valve).

# Part 1 | Section 5 | Baking Chamber and Door Parts (FG150)

Figure 18: Baking Chamber and Door Parts (FG150)

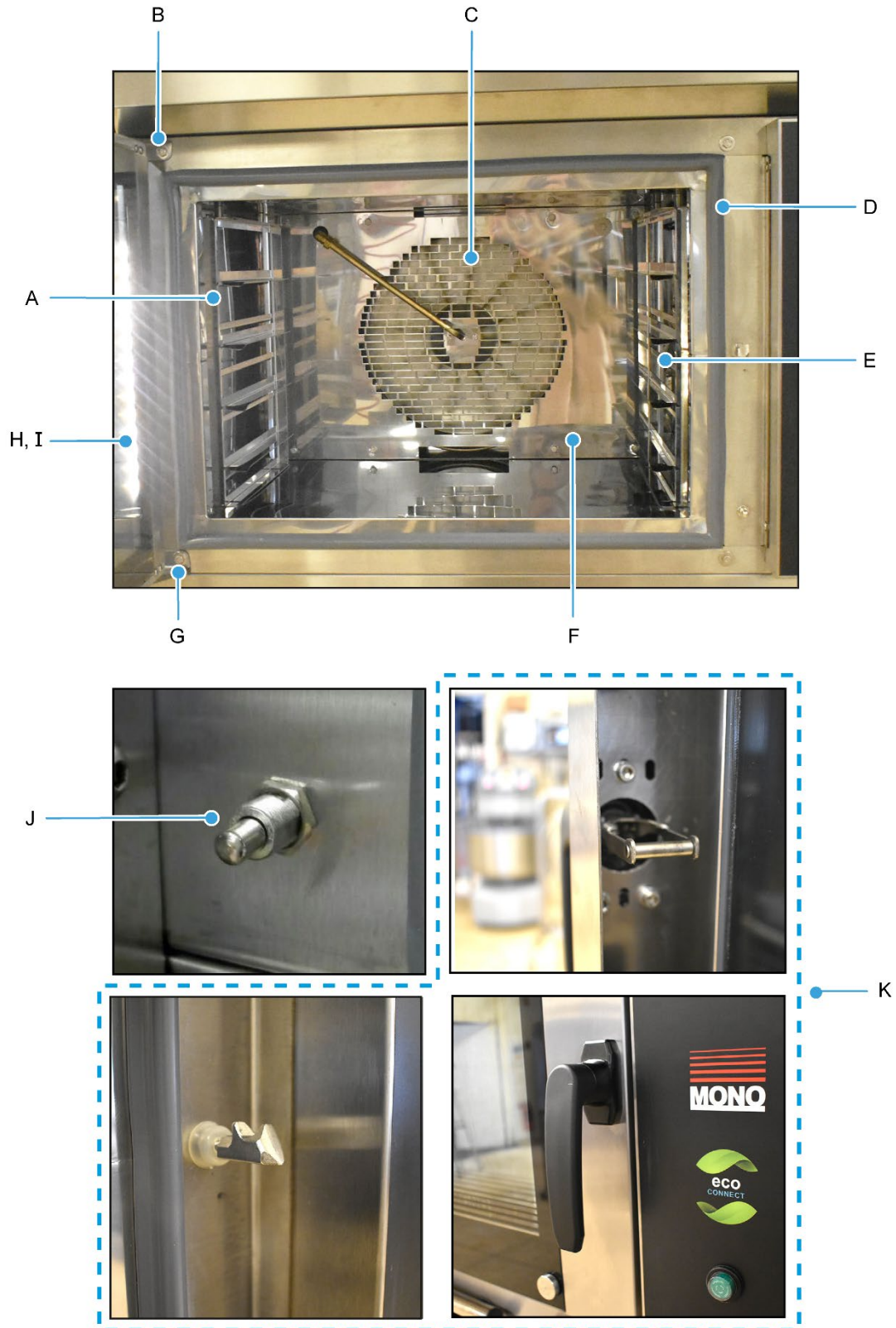

**Table 11: Item numbers in Figure 17**

Item Number	Part Number	Part Description
A	150-01-07201	Side sheet L/H (with fixed runners)
B	149-03-03800	Top hinge L/H oven
	149-03-03801	Top hinge R/H oven
C	150-00-11300	Fan
D	150-03-02500	Door seal
E	150-01-07200	Side sheet R/H (with fixed runners)
F	150-01-06700	Rear sheet
G	150-03-04700	Bottom hinge L/H oven
	150-03-05400	Bottom hinge R/H oven
H	149-03-04100	Outer door glass
I	150-03-10100	Inner door glass
J	B482-07-037	Door switch
K	A900-27-254	Handle/Catch/Latch assembly

**NOTE**

Complete door assembly is part number 150-03-14400 (L/H) and 150-03-14401 (R/H).  
State which is required.

## **PART 2      4/5 Tray 18" x 30" Oven Spares Section**

### **Oven Code FG159**

**Figure 19: Rear view with outer sheeting removed (FG159)**

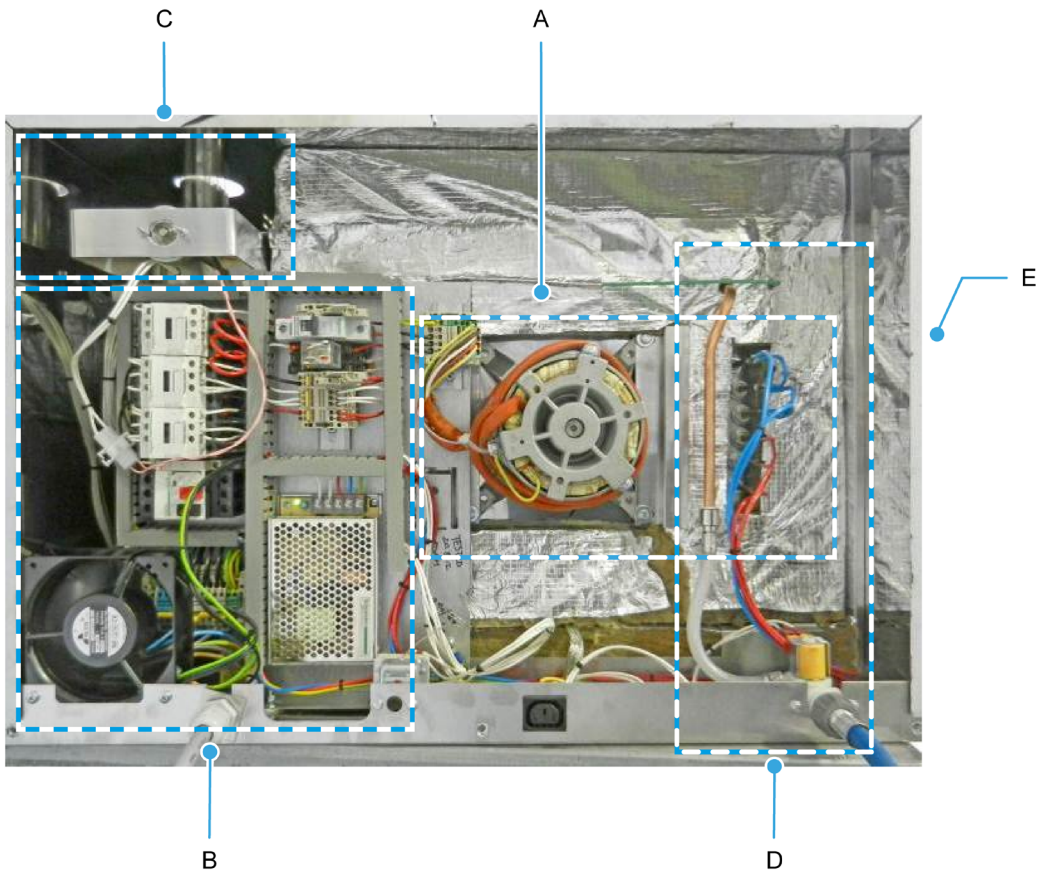

- 
- A. Motor and Element.....** (Part 2 / Section 1 on Page 71)
  - B. Main Panel .....** (Part 2 / Section 2 on Page 72)
  - C. Damper.....** (Part 2 / Section 3 on Page 73)
  - D. Water System.....** (Part 2 / Section 4 on Page 74)
  - E. Baking Chamber and Door Parts .** (Part 2 / Section 5 on Page 76)
-

## Part 2 | Section 1 | Motor and Element (FG159)

Figure 20: Motor and Element (FG159)

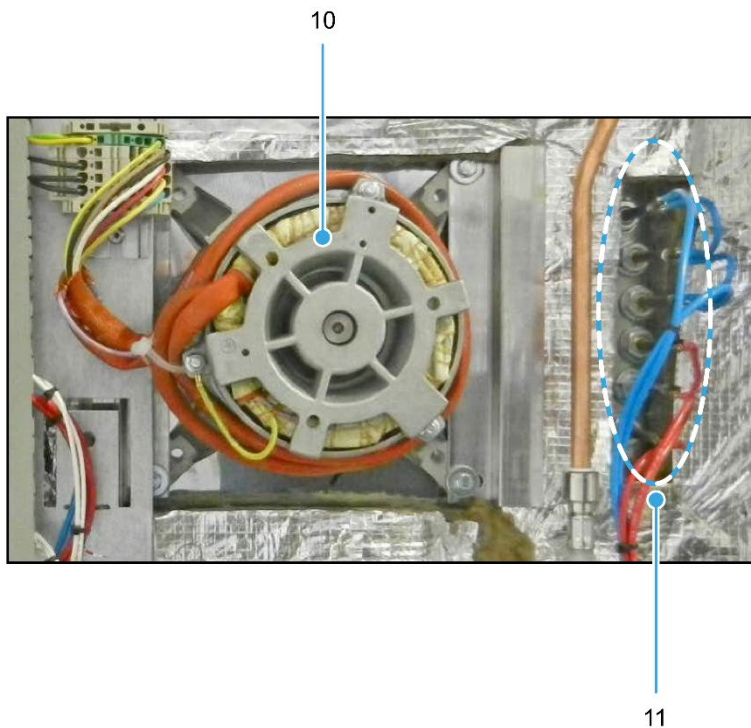

Table 12: Item numbers in Figure 19

Item Number	Part Number	Part Description
10	B720-74-005	Fan motor unit
11	B847-04-068	Heating element, 240 Vac
	B847-04-073	Heating element, 220 Vac

**NOTE**

Part numbers are referenced from electrical drawing M159E25-75000 in the Electrical Manual.

## Part 2 | Section 2 | Main Panel (FG159)

Figure 21: Main Panel (FG159)

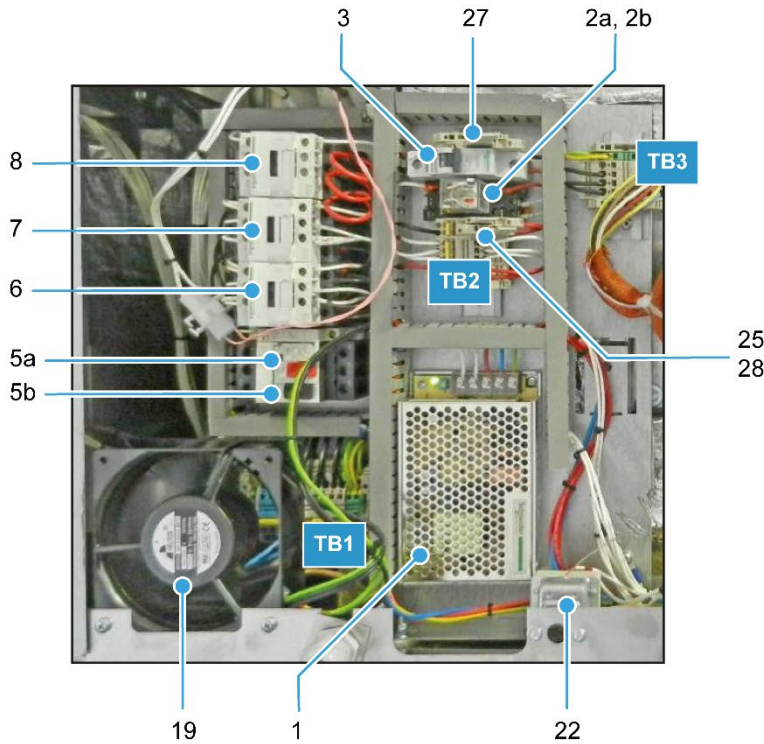

Table 13: Item numbers in Figure 20

Item Number	Part Number	Part Description
1	B801-92-005	Power supply
2a	B723-37-004	Light relay
2b	B723-36-001	Light relay base
3	B872-22-062	Control circuit MCB
5a	B801-03-020	Fan motor overload unit
5b	B801-14-012	Fan motor overload auxiliary contact
6	B801-08-031	Fan motor forward contact
7	B801-08-031	Fan motor reverse contact
8	B801-08-021	Element contactor
19	B869-75-018	Rear cooling fan
22	B888-30-014	Overheat thermostat
25	B842-85-042	Light fuse
27	B842-85-025	Fan fuse
28	B842-85-039	Auxiliary socket fuse

**NOTE**

Part numbers are referenced from electrical drawing M159E25-75000 in the Electrical Manual.



## Part 2 | Section 3 | Damper (FG159)

Figure 22: Damper (FG159)

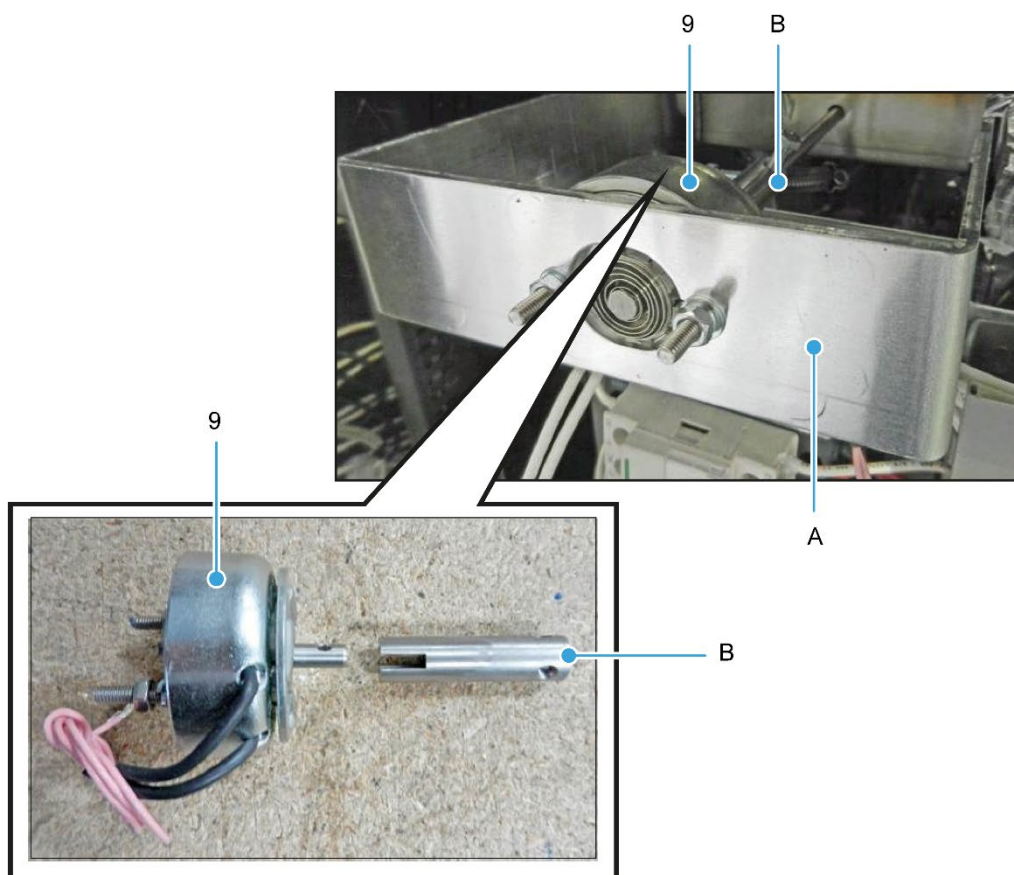

Table 14: Item numbers in Figure 21

Item Number	Part Number	Part Description
9	B749-83-003	Damper solenoid L/H oven
	B749-83-004	Damper solenoid R/H oven
A	158-02-00300	Damper solenoid bracket
B	158-02-00600	Coupling

**NOTE**

Part numbers are referenced from electrical drawing M159E25-75000 in the Electrical Manual.

## Part 2 | Section 4 | Water/Steam System (FG159)

Figure 23: Water/Steam System (FG159) – 1

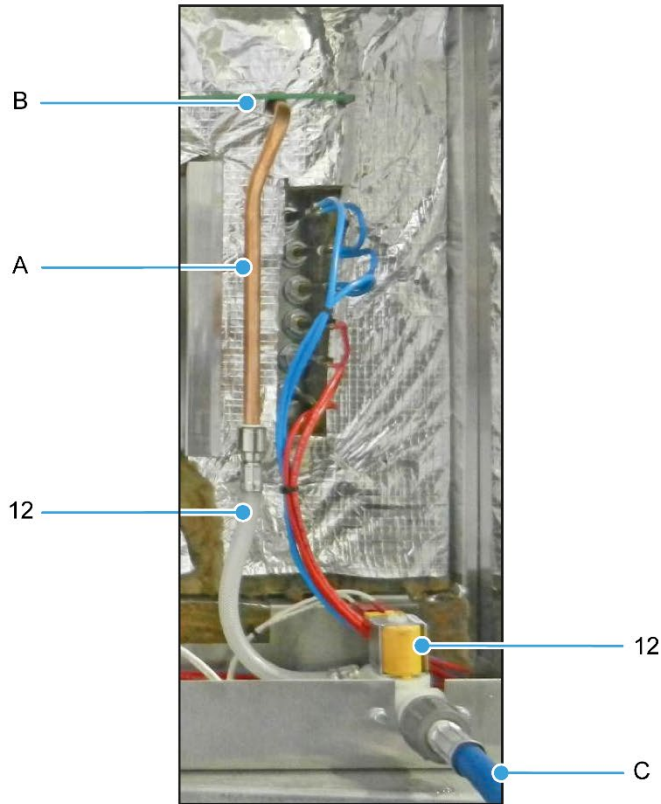

Table 15: Item numbers in Figure 22

Item Number	Part Number	Part Description
12	158-17-00400	Water inlet assembly (including hose)
A	A900-34-253	Copper pipe (10 mm OD x 20 SWG)
B	A900-34-321	Bulkhead coupling (under insulation)
C	A900-34-087	Hose – blue

**NOTE**

Part numbers are referenced from electrical drawing M159E25-75000 in the Electrical Manual.

**Figure 24: Water/Steam System (FG159) – 2**

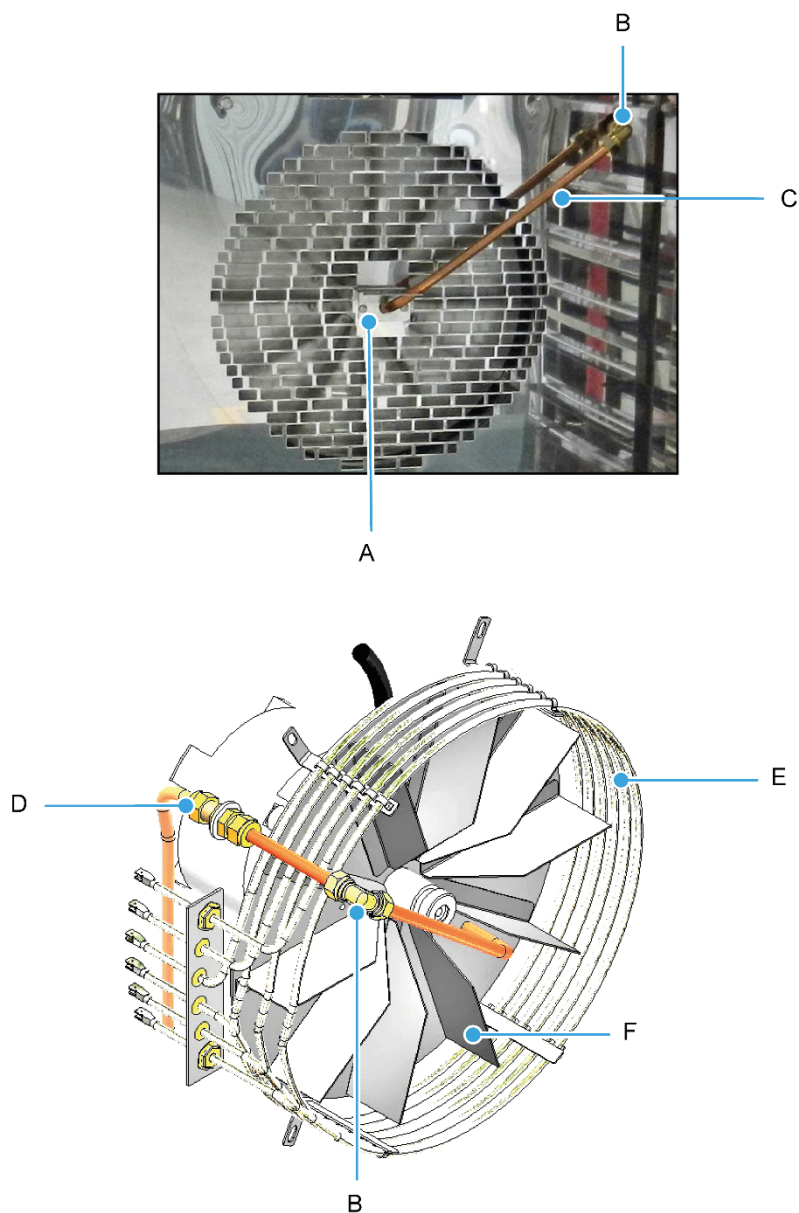

**Table 16: Item numbers in Figure 23**

Item Number	Part Number	Part Description
A	150-01-07700	Pipe guide bracket
B	A900-34-387	Equal elbow
C	(1)	Pipe
D	A900-34-321	Bulkhead coupling
E	B847-04-068	Heating element, 240 Vac
	B847-04-073	Heating element, 220 Vac
F	150-00-11300	Fan

(1) Individual part numbers not available for pipes. All pipes made from A900-34-253 Copper Pipe 10 mm O/D x 20 SWG wall.

## Part 2 | Section 5 | Baking Chamber and Door Parts (FG159)

Figure 25: Baking Chamber and Door Parts (FG159)

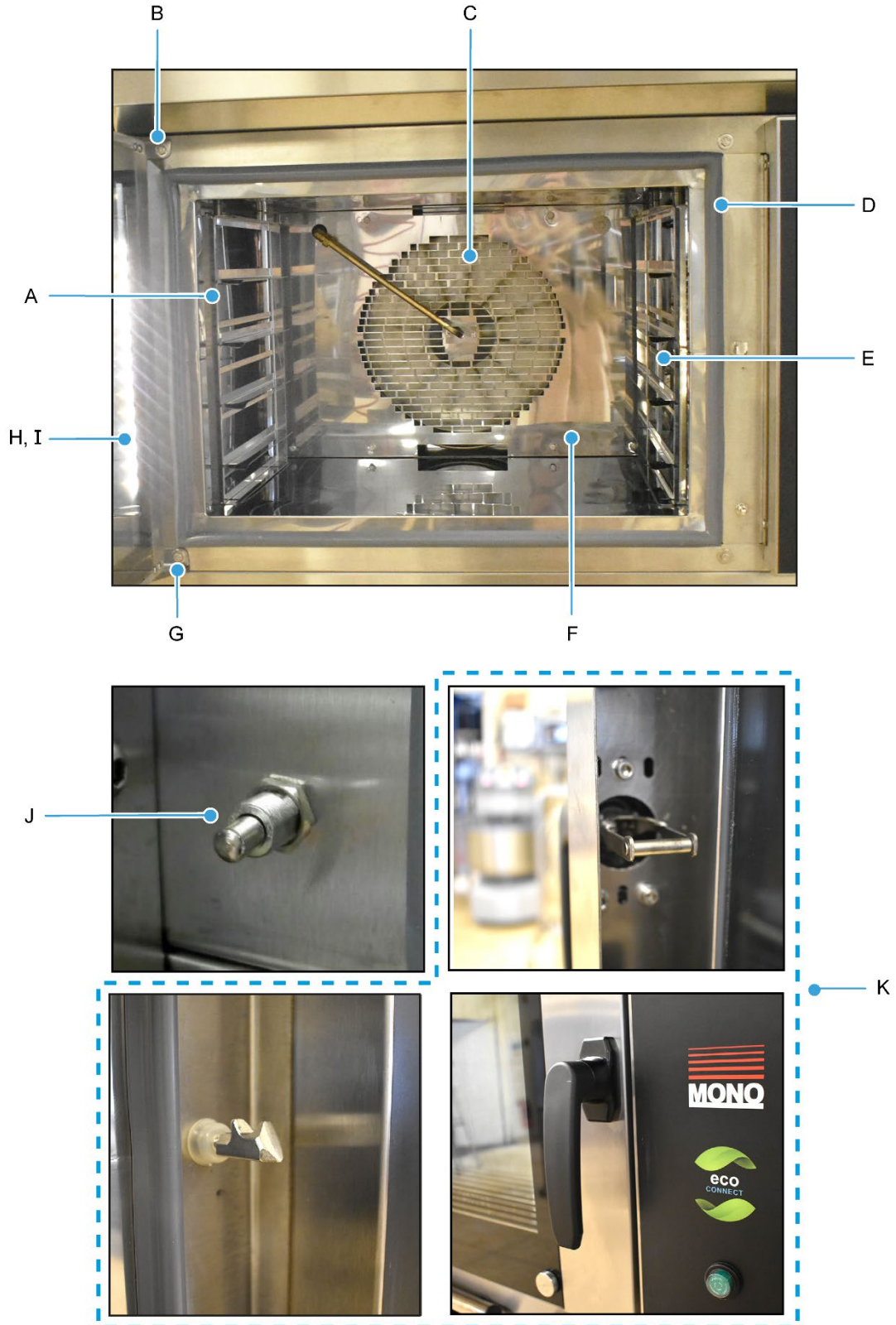

**Table 17: Item numbers in Figure 24**

Item Number	Part Number	Part Description
A	159-01-05000	L/H fixed runners, 4 tray
	159-01-05200	L/H fixed runners, 5 tray
B	158-03-10501	Top hinge L/H oven
	158-03-10500	Top hinge R/H oven
C	150-00-11300	Fan
D	159-03-01500	Door seal
E	159-01-05001	R/H fixed runners, 4 tray
	159-01-05201	R/H fixed runners, 5 tray
F	159-05-00400	Rear sheet
G	158-03-05200	Bottom hinge L/H oven
	158-03-05201	Bottom hinge R/H oven
H	153-03-04000	Outer door glass
I	159-03-06600	Inner door including glass
J	B482-07-037	Door switch
K	A900-27-254	Handle/Catch/Latch assembly

**NOTE**

Complete door assembly part numbers are:  
 159-03-06500 (L/H hinge door) and 159-03-06501 (R/H hinge door).

## **PART 3      4/5 Tray 60cm x 40cm Oven Spares Section**

### **Oven Code FG158**

**Figure 26: Rear view with outer sheeting removed (FG158)**

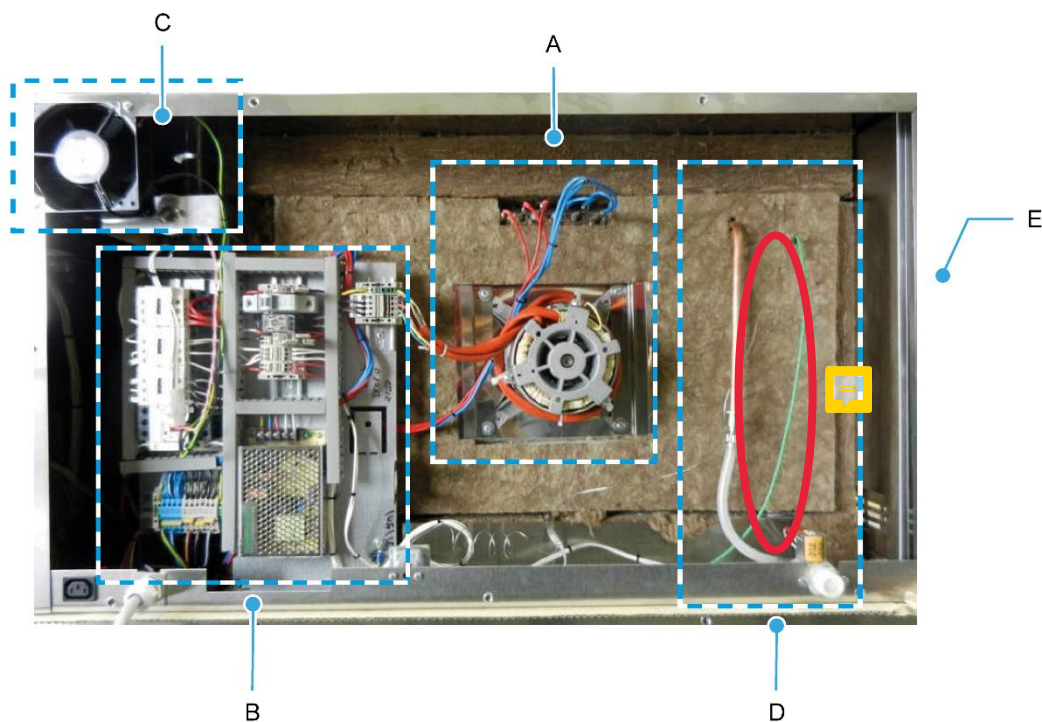

- 
- A.** Motor and Element..... (Part 3 / Section 1 on Page 79)
  - B.** Main Panel ..... (Part 3 / Section 2 on Page 80)
  - C.** Damper and fan ..... (Part 3 / Section 3 on Page 81)
  - D.** Water System..... (Part 3 / Section 4 on Page 82)
  - E.** Baking Chamber and Door Parts . (Part 3 / Section 5 on Page 84)
-

## Part 3 | Section 1 | Motor and Element (FG158)

Figure 27: Motor and Element (FG158)

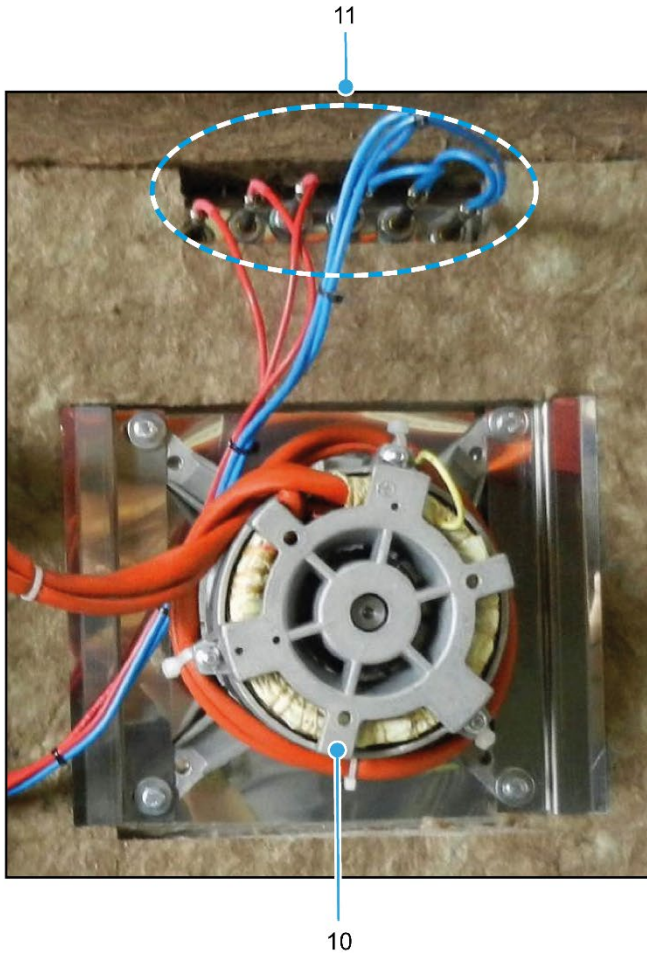

Table 18: Item numbers in Figure 26

Item Number	Part Number	Part Description
10	B720-74-005	Fan motor unit
11	B847-04-067	Heating element, 240 Vac
	B847-04-074	Heating element, 220 Vac

**NOTE**

Part numbers are referenced from electrical drawing M158E25-75200 in the Electrical Manual.

## Part 3 | Section 2 | Main Panel (FG158)

Figure 28: Main Panel (FG158)

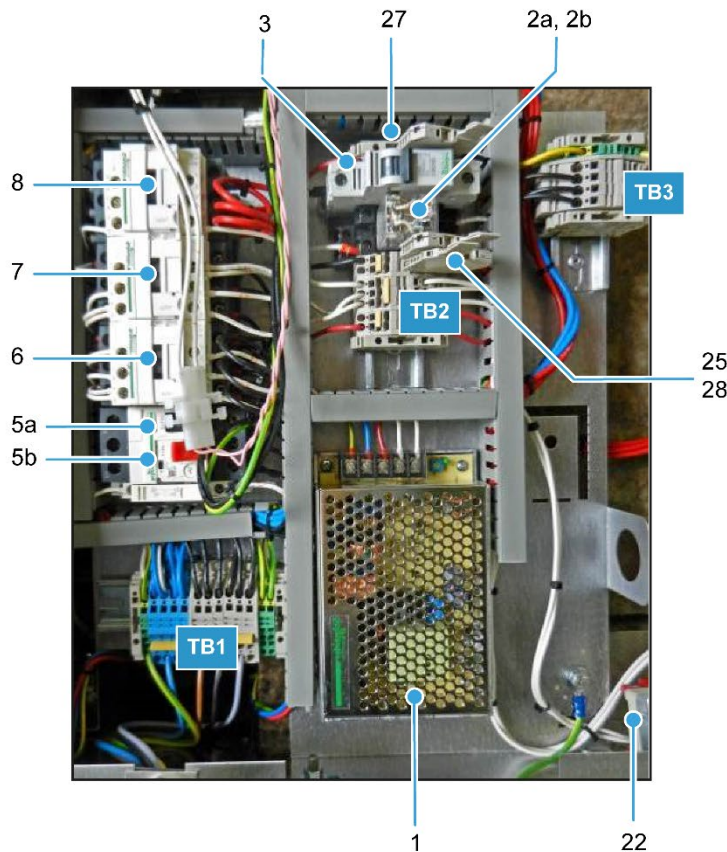

Table 19: Item numbers in Figure 27

Item Number	Part Number	Part Description
1	B801-93-005	Power supply
2a	B723-37-004	Light relay
2b	B723-36-001	Light relay base
3	B872-22-062	Control circuit MCB
5a	B801-03-020	Fan motor overload unit
5b	B801-14-012	Fan motor overload auxiliary contact
6	B801-08-031	Fan motor forward contact
7	B801-08-031	Fan motor reverse contact
8	B801-08-021	Element contactor
22	B888-30-014	Overheat thermostat
25	B842-85-042	Light fuse
27	B842-85-025	Fan fuse
28	B842-85-039	Auxiliary socket fuse

**NOTE**

Part numbers are referenced from electrical drawing M158E25-75200 in the Electrical Manual.



## Part 3 | Section 3 | Damper and Cooling Fan (FG158)

Figure 29: Damper and Cooling Fan (FG158)

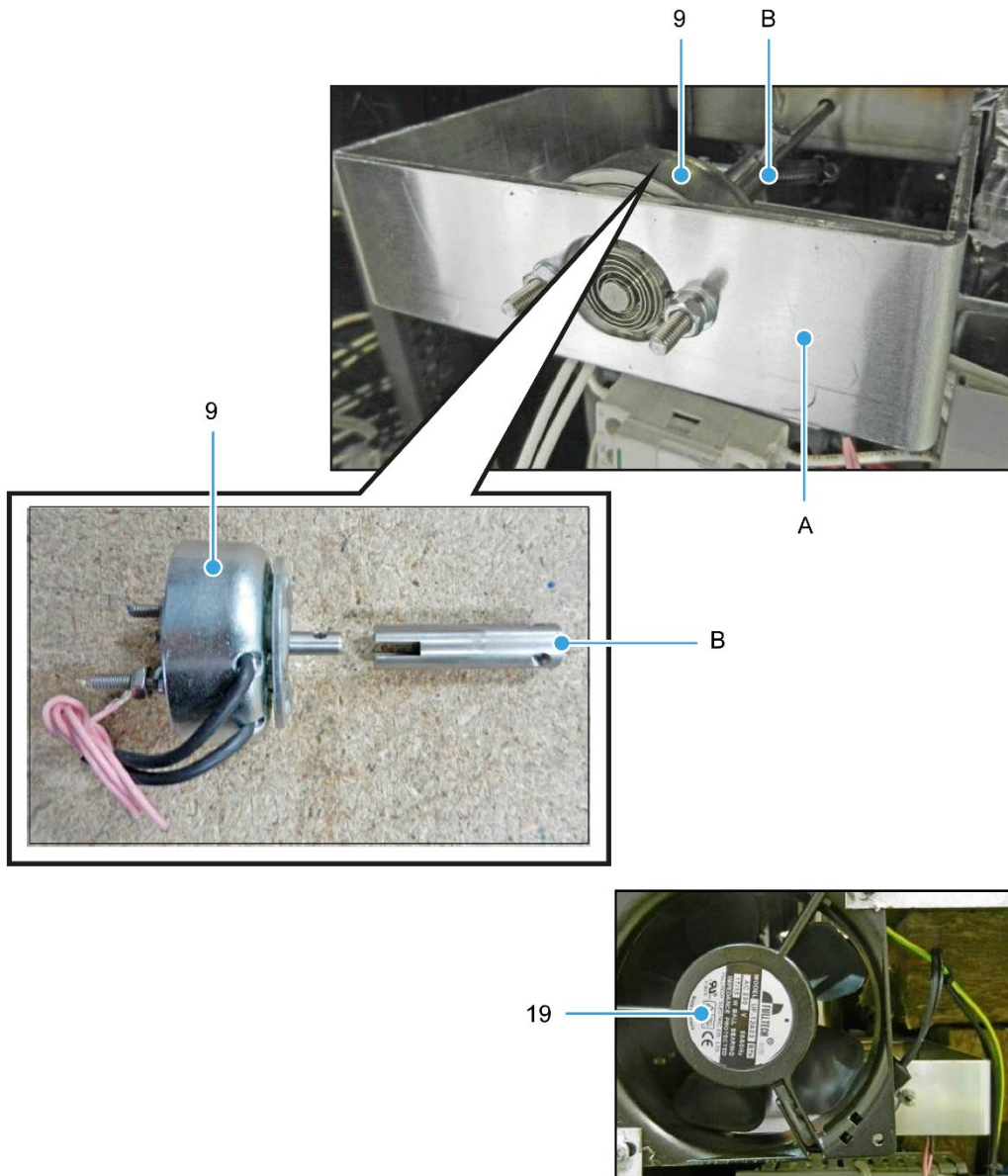

Table 20: Item numbers in Figure 28

Item Number	Part Number	Part Description
9	B749-83-003	Damper solenoid L/H oven
	B749-83-004	Damper solenoid R/H oven
19	B869-75-018	Rear cooling fan
A	158-02-00300	Damper solenoid bracket
B	158-02-00600	Coupling

**NOTE**

Part numbers are referenced from electrical drawing M158E25-75200 in the Electrical Manual.

## Part 3 | Section 4 | Water/Steam System (FG158)

Figure 30: Water/Steam System (FG158) – 1

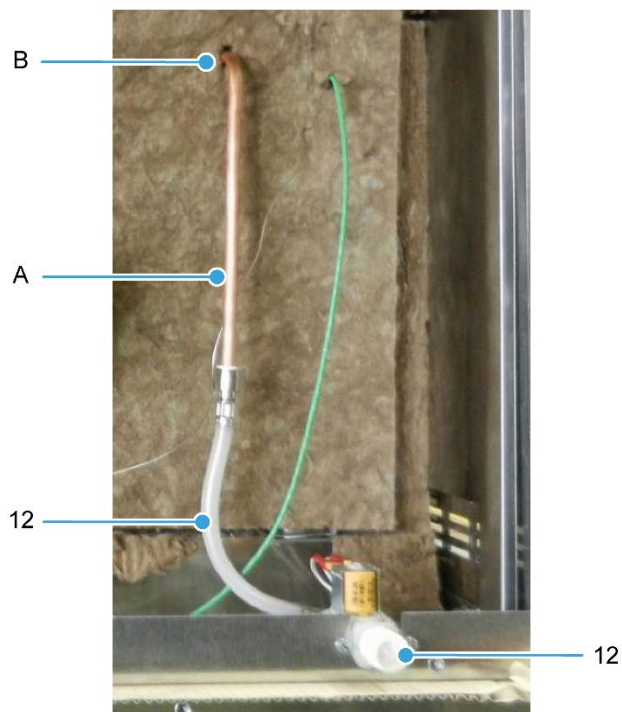

Table 21: Item numbers in Figure 29

Item Number	Part Number	Part Description
12	158-17-00400	Water inlet assembly (including hose)
A	A900-34-253	Copper pipe (10 mm OD x 20 SWG)
B	A900-34-321	Bulkhead coupling (under insulation)
N/A	A900-34-087	Hose – blue (not shown)

**NOTE**

Part numbers are referenced from electrical drawing M158E25-75200 in the Electrical Manual.

**Figure 31: Water/Steam System (FG158) – 2**

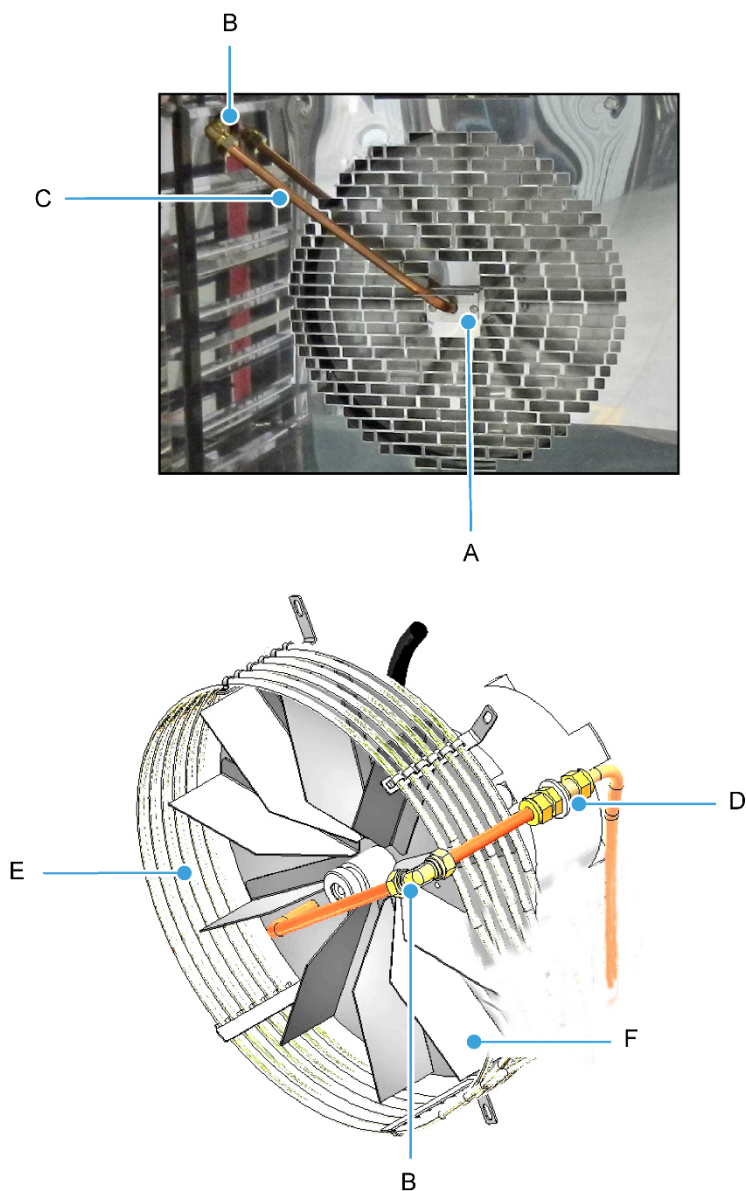

**Table 22: Item numbers in Figure 30**

Item Number	Part Number	Part Description
A	150-01-07700	Pipe guide bracket
B	A900-34-387	Equal elbow
C	(1)	Pipe
D	A900-34-321	Bulkhead coupling
E	B847-04-067	Heating element, 240 Vac
	B847-04-074	Heating element, 220 Vac
F	150-00-11200	Fan

(1) Individual part numbers not available for pipes. All pipes made from A900-34-253 Copper Pipe 10 mm O/D x 20 SWG wall.

# Part 3 | Section 5 | Baking Chamber and Door Parts (FG158)

Figure 32: Baking Chamber and Door Parts (FG158)

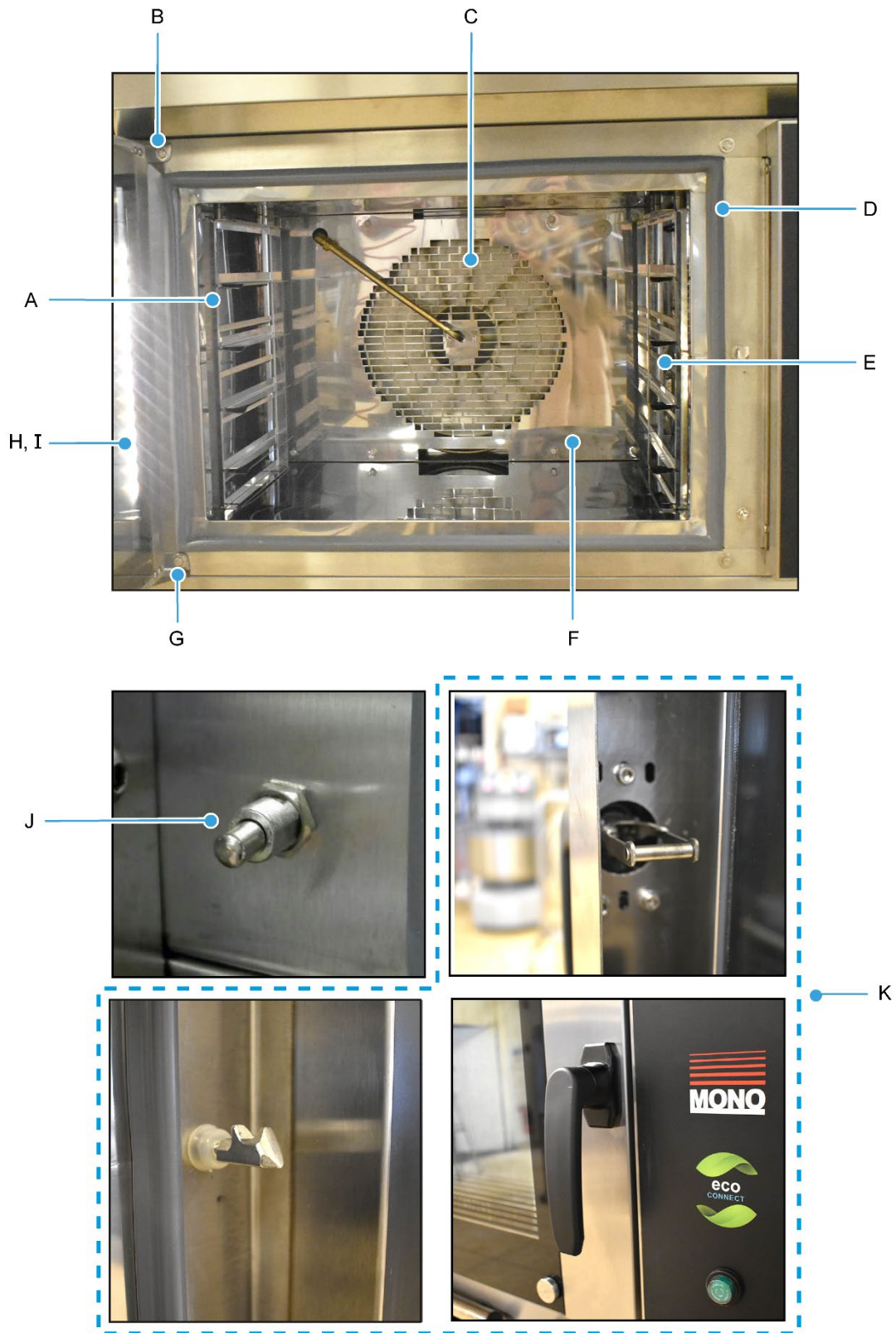

**Table 23: Item numbers in Figure 31**

Item Number	Part Number	Part Description
A	158-04-01000	L/H runner rack, 4/5 tray
B	158-03-10501	Top hinge L/H oven
	158-03-10500	Top hinge R/H oven
C	158-00-11200	Fan
D	158-03-01500	Door seal
E	158-04-01001	R/H runner rack, 4/5 tray
F	158-05-13300	Rear sheet
G	158-03-05200	Bottom hinge L/H oven
	158-03-05201	Bottom hinge R/H oven
H	158-03-06000	Outer door glass
I	158-03-41600	Inner door glass
J	B482-07-037	Door switch
K	A900-27-254	Handle/Catch/Latch assembly

**NOTE**

Complete door assembly part numbers are:  
 158-03-05900 (L/H hinge door) and 158-03-05901 (R/H hinge door).

## **PART 4      4/5 Tray 40cm x 60cm Oven Spares Section**

### **Oven Code FG153**

**Figure 33: Rear view with outer sheeting removed (FG153)**

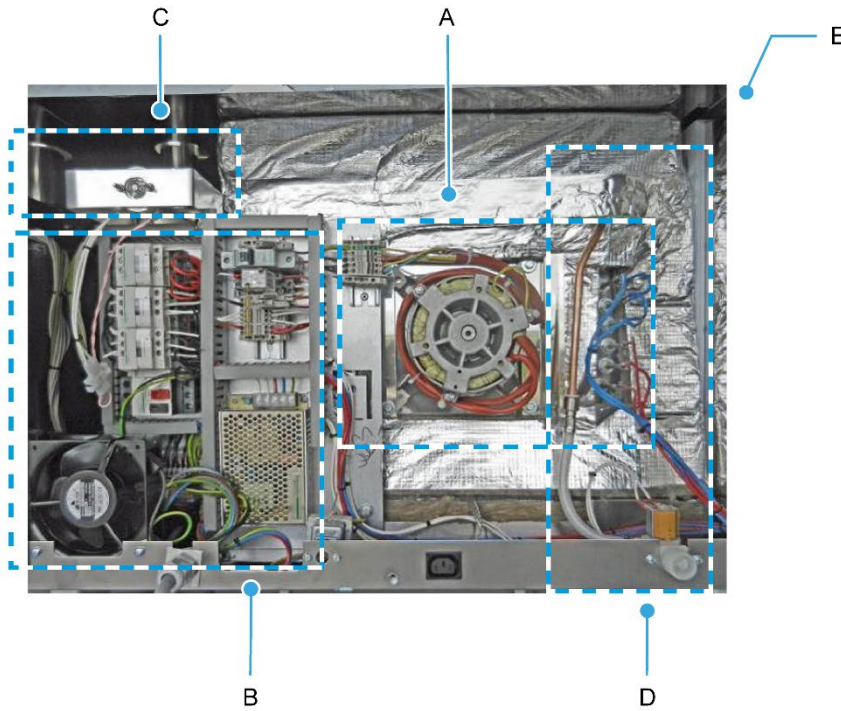

- 
- A. Motor and Element..... (Part 4 / Section 1 on Page 87)**
  - B. Main Panel ..... (Part 4 / Section 2 on Page 88)**
  - C. Damper and fan ..... (Part 4 / Section 3 on Page 89)**
  - D. Water System..... (Part 4 / Section 4 on Page 90)**
  - E. Baking Chamber and Door Parts . (Part 4 / Section 5 on Page 92)**
-

## Part 4 | Section 1 | Motor and Element (FG153)

Figure 34: Motor and Element (FG153)

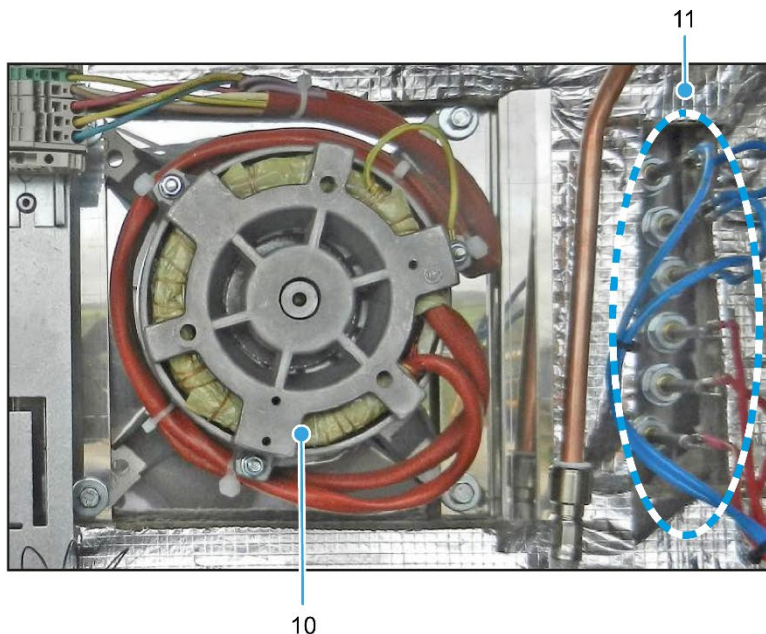

Table 24: Item numbers in Figure 33Figure 26

Item Number	Part Number	Part Description
10	B720-74-005	Fan motor unit
11	B847-04-067	Heating element, 240 Vac
	B847-04-074	Heating element, 220 Vac

**NOTE**

Part numbers are referenced from electrical drawing M158E25-75200 in the Electrical Manual.

## Part 4 | Section 2 | Main Panel (FG153)

Figure 35: Main Panel (FG153)

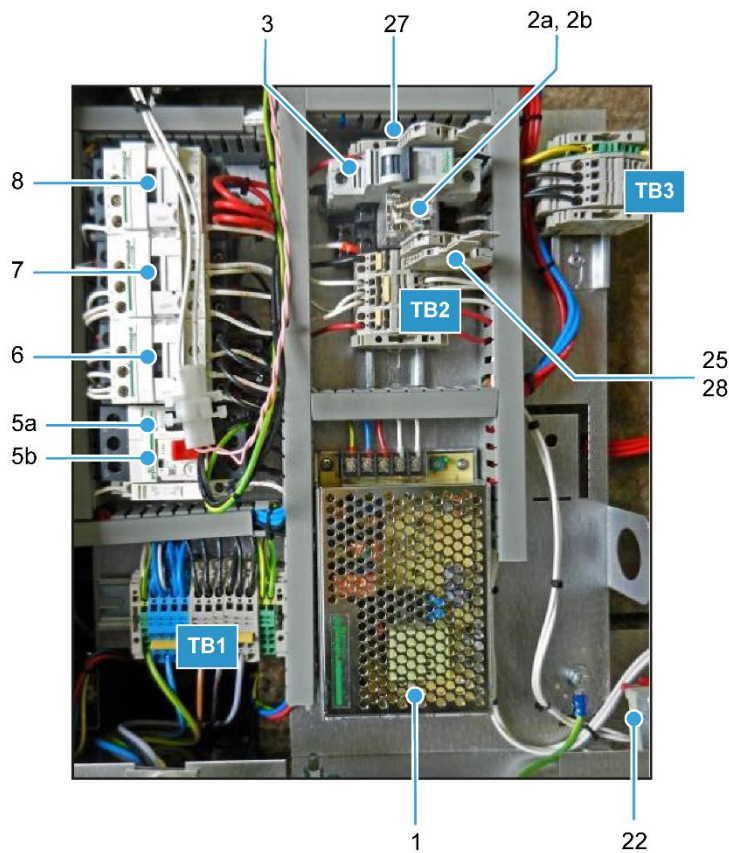

Table 25: Item numbers in Figure 34Figure 27

Item Number	Part Number	Part Description
1	B801-93-005	Power supply
2a	B723-37-004	Light relay
2b	B723-36-001	Light relay base
3	B872-22-062	Control circuit MCB
5a	B801-03-020	Fan motor overload unit
5b	B801-14-012	Fan motor overload auxiliary contact
6	B801-08-031	Fan motor forward contact
7	B801-08-031	Fan motor reverse contact
8	B801-08-021	Element contactor
22	B888-30-014	Overheat thermostat
25	B842-85-042	Light fuse
27	B842-85-025	Fan fuse
28	B842-85-039	Auxiliary socket fuse

**NOTE**

Part numbers are referenced from electrical drawing M158E25-75200 in the Electrical Manual.



## Part 4 | Section 3 | Damper and Cooling Fan (FG153)

Figure 36: Damper and Cooling Fan (FG153)

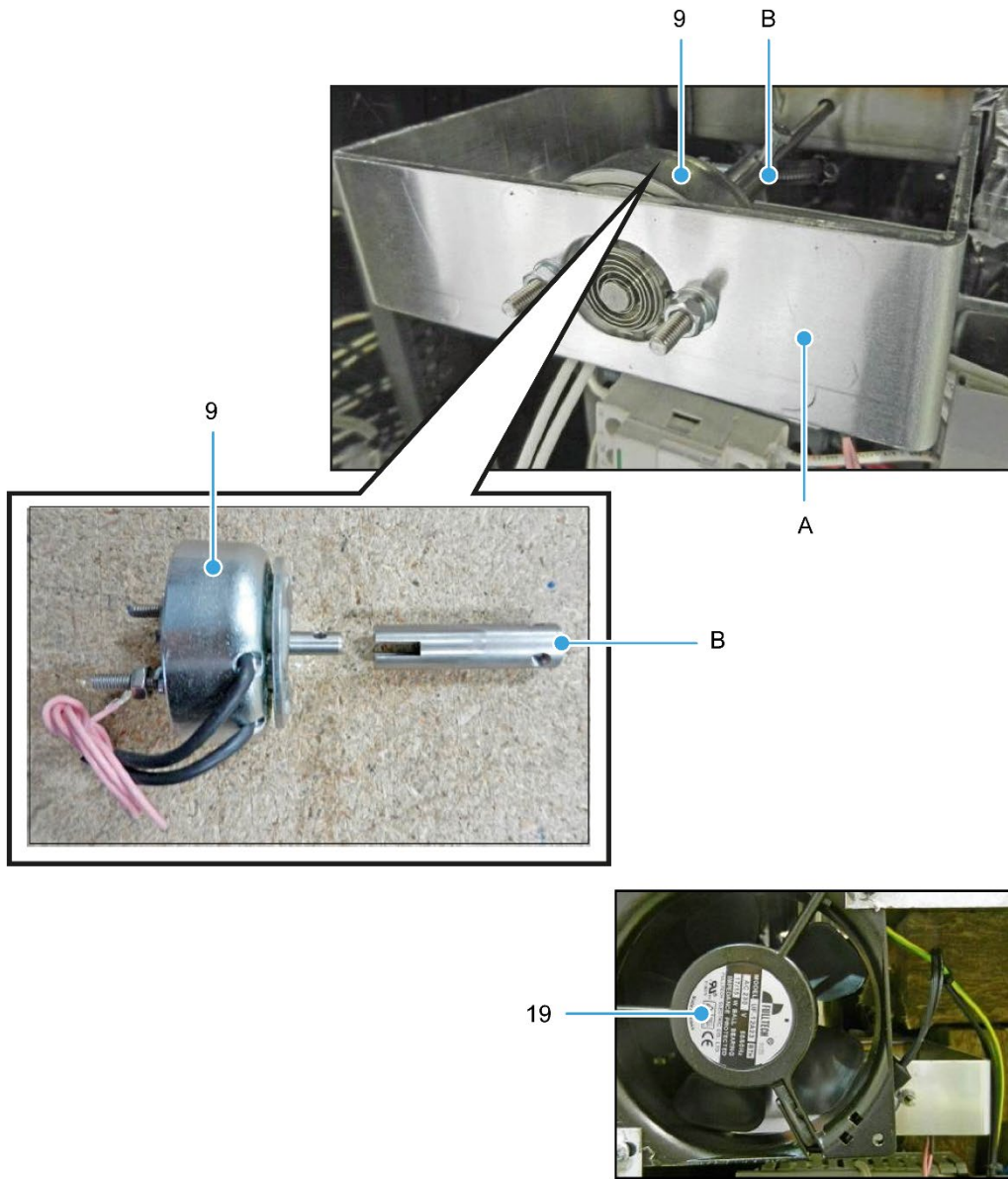

Table 26: Item numbers in Figure 35

Item Number	Part Number	Part Description
9	B749-83-003	Damper solenoid L/H oven
	B749-83-004	Damper solenoid R/H oven
19	B869-75-018	Rear cooling fan
A	158-02-00300	Damper solenoid bracket
B	158-02-00600	Coupling

**NOTE**

Part numbers are referenced from electrical drawing M158E25-75200 in the Electrical Manual.

## Part 4 | Section 4 | Water/Steam System (FG153)

Figure 37: Water/Steam System (FG153) – 1

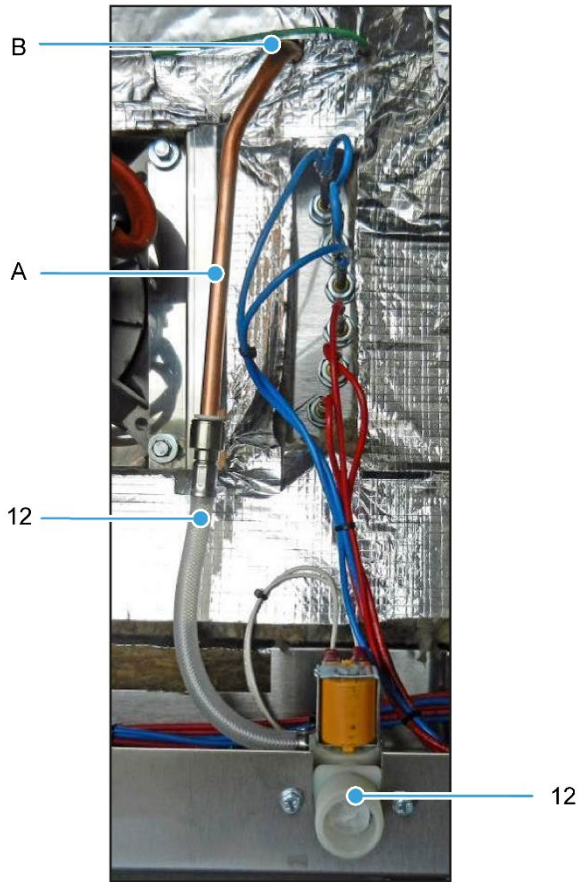

Table 27: Item numbers in Figure 36Figure 29

Item Number	Part Number	Part Description
12	158-17-00400	Water inlet assembly (including hose)
A	A900-34-253	Copper pipe (10 mm OD x 20 SWG)
B	A900-34-321	Bulkhead coupling (under insulation)
N/A	A900-34-087	Hose – blue (Not shown)

**NOTE**

Part numbers are referenced from electrical drawing M158E25-75200 in the Electrical Manual.

**Figure 38: Water/Steam System (FG153) – 2**

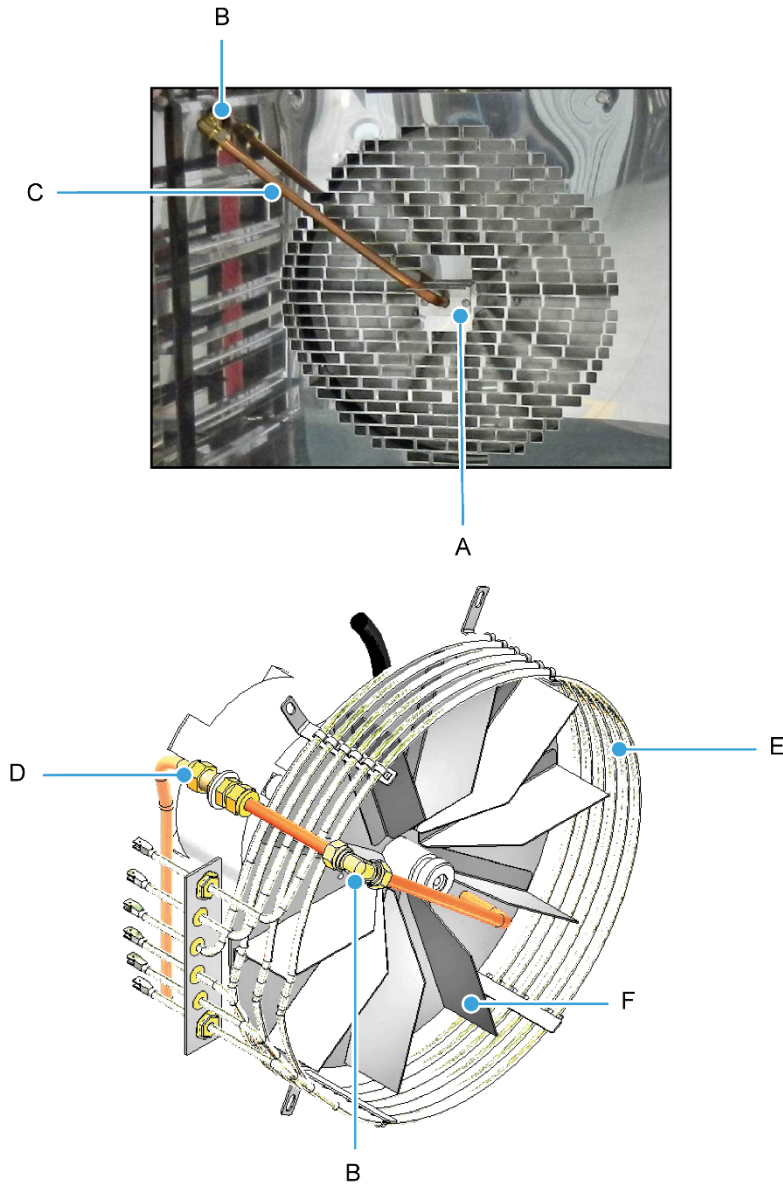

**Table 28: Item numbers in Figure 37**

Item Number	Part Number	Part Description
A	150-01-07700	Pipe guide bracket
B	A900-34-387	Equal elbow
C	(1)	Pipe
D	A900-34-321	Bulkhead coupling
E	B847-04-067	Heating element, 240 Vac
	B847-04-074	Heating element, 220 Vac
F	150-00-11200	Fan

(1) Individual part numbers not available for pipes. All pipes made from A900-34-253 Copper Pipe 10 mm O/D x 20 SWG wall.

# Part 4 | Section 5 | Baking Chamber and Door Parts (FG153)

Figure 39: Baking Chamber and Door Parts (FG153)

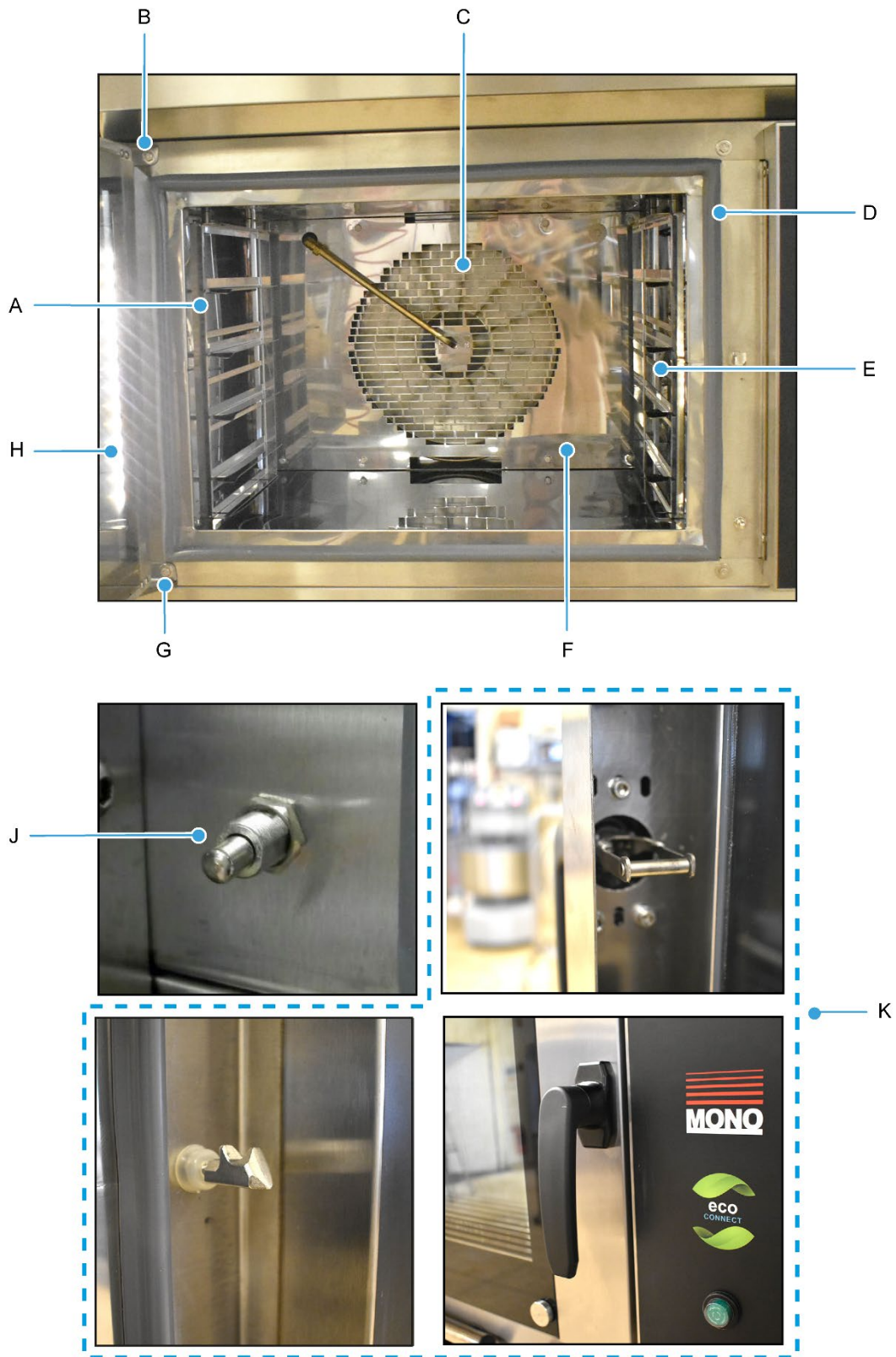

**Table 29: Item numbers in Figure 38**

Item Number	Part Number	Part Description
A	149-01-07101	L/H clip-on runner
B	158-03-10501	Top hinge L/H oven
	158-03-10500	Top hinge R/H oven
C	158-00-11200	Fan
D	153-23-00500	Door seal
E	149-01-07100	R/H clip-on runner
F	153-51-00900	Rear sheet
G	158-03-05200	Bottom hinge L/H oven
	158-03-05201	Bottom hinge R/H oven
H	153-03-01700	Outer/inner door glass
J	B482-07-037	Door switch
K	A900-27-254	Handle/Catch/Latch assembly

**NOTE**

Complete door assembly part numbers are:

153-03-05900 (L/H hinge door) and 153-03-05901 (R/H hinge door).

# 11. Condenser Unit (Option)

**CAUTION**

- All versions should be part of a regular cleaning schedule. Water should be drained and parts cleaned with an antibacterial wash.

## Index

<b>Introduction</b> .....	page 95
<b>Dimensions</b> .....	page 96
<b>Specifications</b> .....	page 97
<b>Safety</b> .....	page 98
<b>Installation</b> .....	page 99
<b>Operation</b> .....	page 102
<b>Spares</b> .....	page 103
<b>Other versions that may be fitted</b> .....	page 105

**NOTE**

See the Electrics Manual for electrical information.

## Introduction (condenser unit)

A condenser unit can be fitted to a MONO oven (or stacked ovens). The thermostatic control can be adjusted to operate in most ambient temperatures. A simple water connection (washing machine type fitting) and a hose to drain are required to operate efficiently.

Steam is drawn from the flue pipe of the oven through a thermostatically-controlled water-cooled chamber and condenses to drain away. When the cooling water reaches a set temperature, it is automatically replaced with cold water to keep the condensing process as efficient as possible.

**Figure 40: Features of a typical condenser unit**

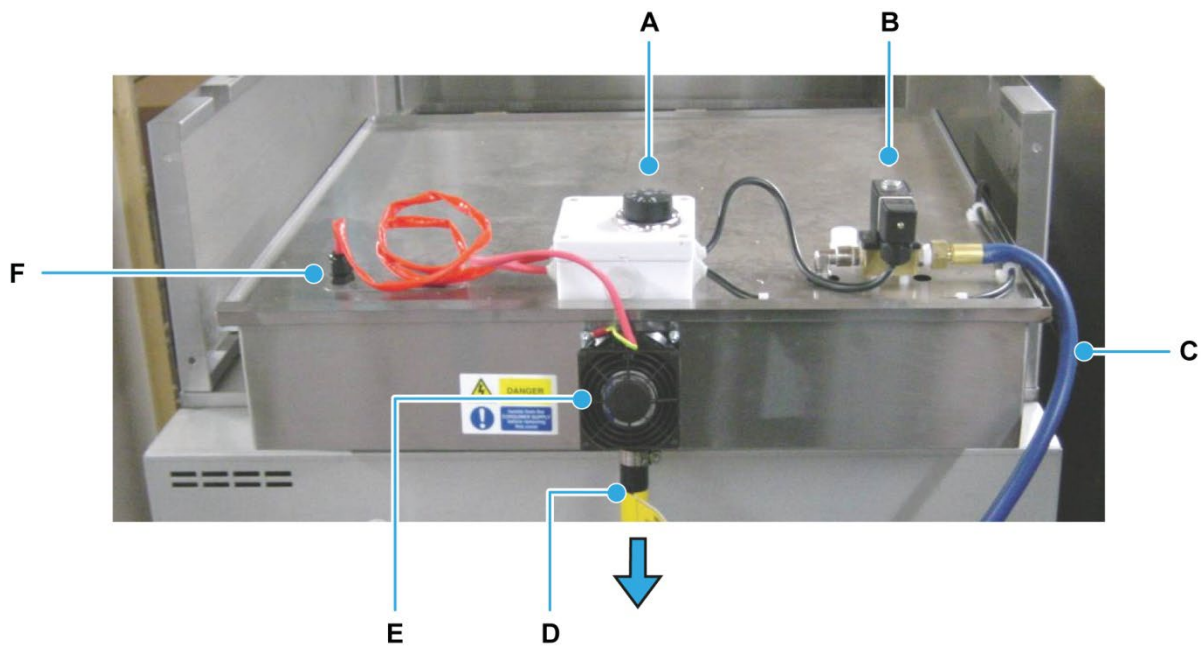

- 
- A. Thermostat control
  - B. Water solenoid
  - C. Water inlet
  - D. Water outlet to drain
  - E. Fan
  - F. Thermostat
-

## Dimensions (condenser unit)

Figure 41: Dimensions of a condenser unit

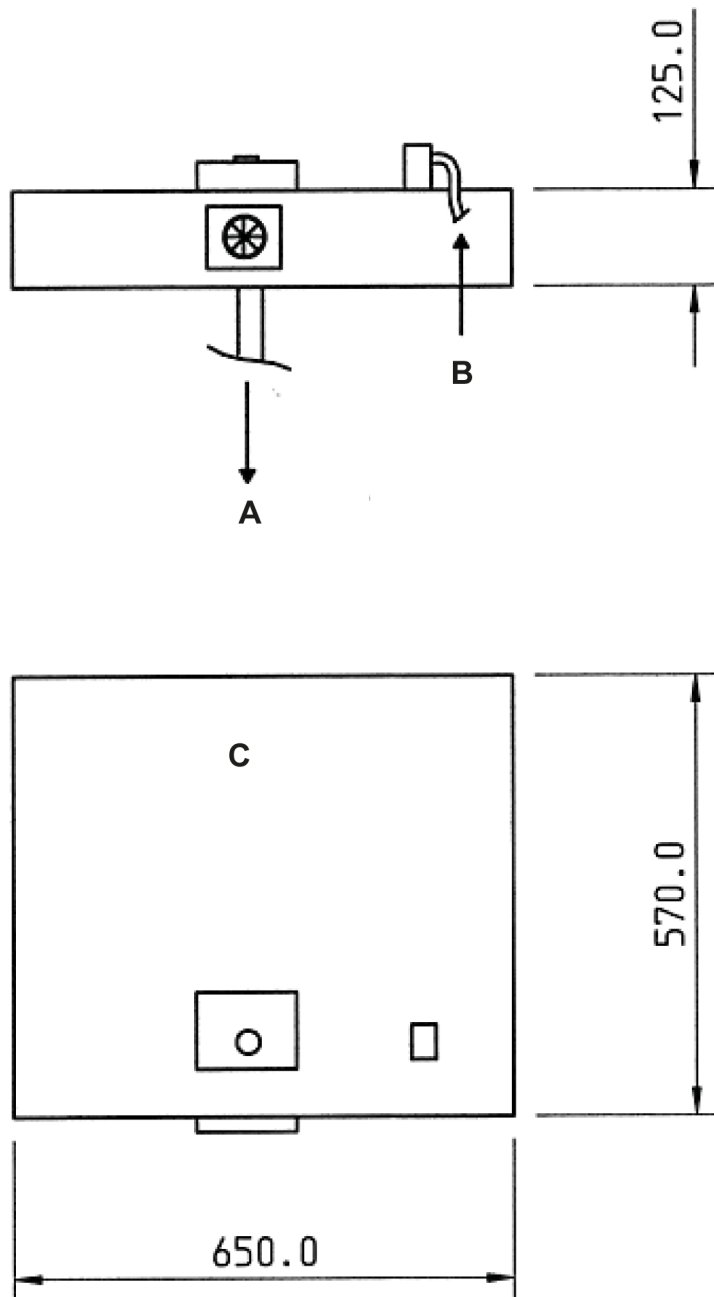

- 
- A. Water out
  - B. Water in
  - C. Rear of the oven
-



## Specifications (condenser unit)

### Power

- 230 Vac (50 Hz), single phase
- 21 Watts
- Wired to the oven electrical panel.

### Water

- Washing machine type connection to the normal water supply via steam water connection to the oven(s).

### Noise

- Less than 85 dB

### Weight

- Approximately 18 kg / 39.7 lb (excluding water)

## Safety (condenser unit)

Always disconnect or isolate the power supply before installation, and allow the oven to cool for several hours. Only fully trained and experienced electricians are authorised to do electrical repairs and installation work on the MONO Eco Connect Convection Oven.

**WARNING**

- Before testing the oven with the condenser, check that:
    - All cover panels and pipe fittings are secure.
    - The door handles are not damaged.
  - Operate the condenser only as described in this manual.
  - All versions should be part of a regular cleaning schedule. Water should be drained, and parts cleaned with an antibacterial wash.
- 

**WARNING**

- All connections to the oven must comply with the statutory requirements of the country of installation.
- 

**CAUTION**

- Be aware of hot surfaces.
    - While the oven is in operation (and for some time after use), touching the condenser or the surroundings is inadvisable because of conducted heat.
  - No unauthorised modifications to the condenser are permitted.
  - Only use MONO spare parts on this condenser.
-

## Installation (condenser unit)

1. Ensure that all power is disconnected and the oven is cool.
2. Before fitting the main condenser assembly, insert a blanking plug (**Figure 42 | A**) into the lower hole that is not required for this oven type.
3. Connect the tube (**Figure 42 | B**) to the spigot and retain it with a worm-drive clip (**Figure 42 | C**).
4. Place the condenser in position, ensuring that the tube (**B**) passes through the hole in the top of the oven and worm drive clip (**Figure 42 | D**), then over the spigot of the damper assembly on the oven.
5. Tighten the worm-drive clip (**D**).
6. Fasten the condenser unit to the top of the oven with M6 x 12 mm long hex head screws and washers in four positions. (If holes have been drilled, nuts must also be used).
7. Connect wiring, depending on whether the oven is a 4-tray or 10-tray version, as shown in the corresponding Electricals manual.
8. Connect the drain hose to a suitable drain.
9. Attach a water tap bracket to the base frame, as shown, and fasten the water hose to a water supply. (A tee pipe must be used on double ovens).

---

### NOTE

If fixing holes are not present on the top sheet of the oven, they should be marked and drilled at this stage. Position the condenser correctly and mark hole positions (centre of each slot). Remove the condenser and drill holes of 6.5 mm diameter at four positions.

---

**Figure 42: Installation of a condenser unit**

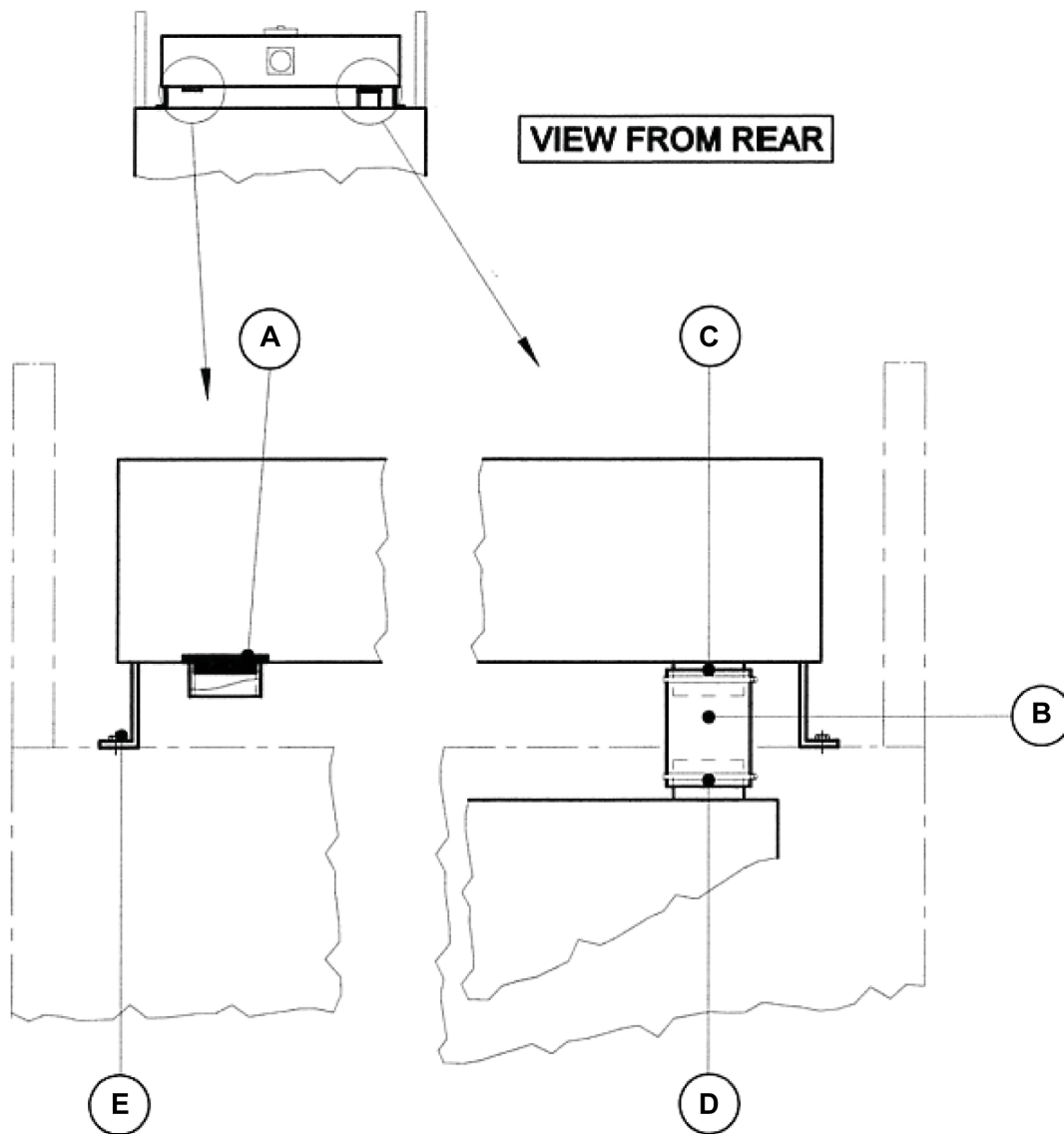

**Figure 43: Water pipe connections**

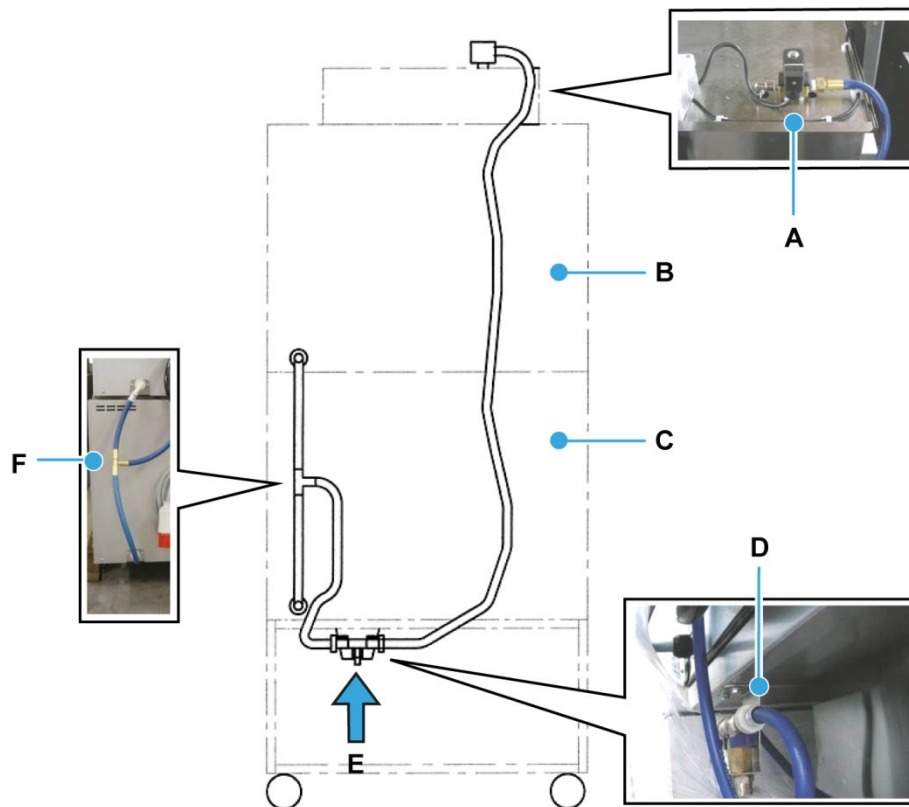

- 
- A. Condenser solenoid
  - B. Oven #1
  - C. Oven #2
  - D. Bracket fixings for the water tap
  - E. Mains water supply inlet
  - F. Tee-pipe for double oven connection
-

## Operation (condenser unit)

1. Review all safety sections in this manual.
2. Ensure the water supply is connected correctly and the oven power is on.
3. Adjust the thermostat control to the required position (**Figure 44**).

It is suggested that, as a starting point, the thermostat is set at 60. It can then be decreased if the performance drops or increased if it is found that the water is being replaced too often.

**Figure 44:** Thermostat control on the condenser

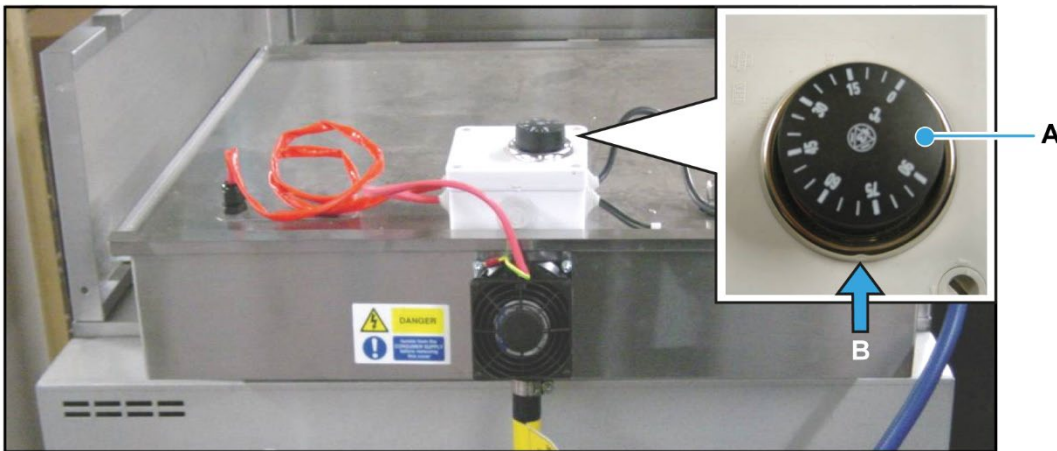

- 
- A. Thermostat control
  - B. Setting position
-

# Spares (condenser unit)

**This section is for Engineer use only**

Do not attempt any modifications to the condenser or oven. If in doubt, contact Mono Equipment for advice.

**Figure 45: Main parts of the condenser unit**

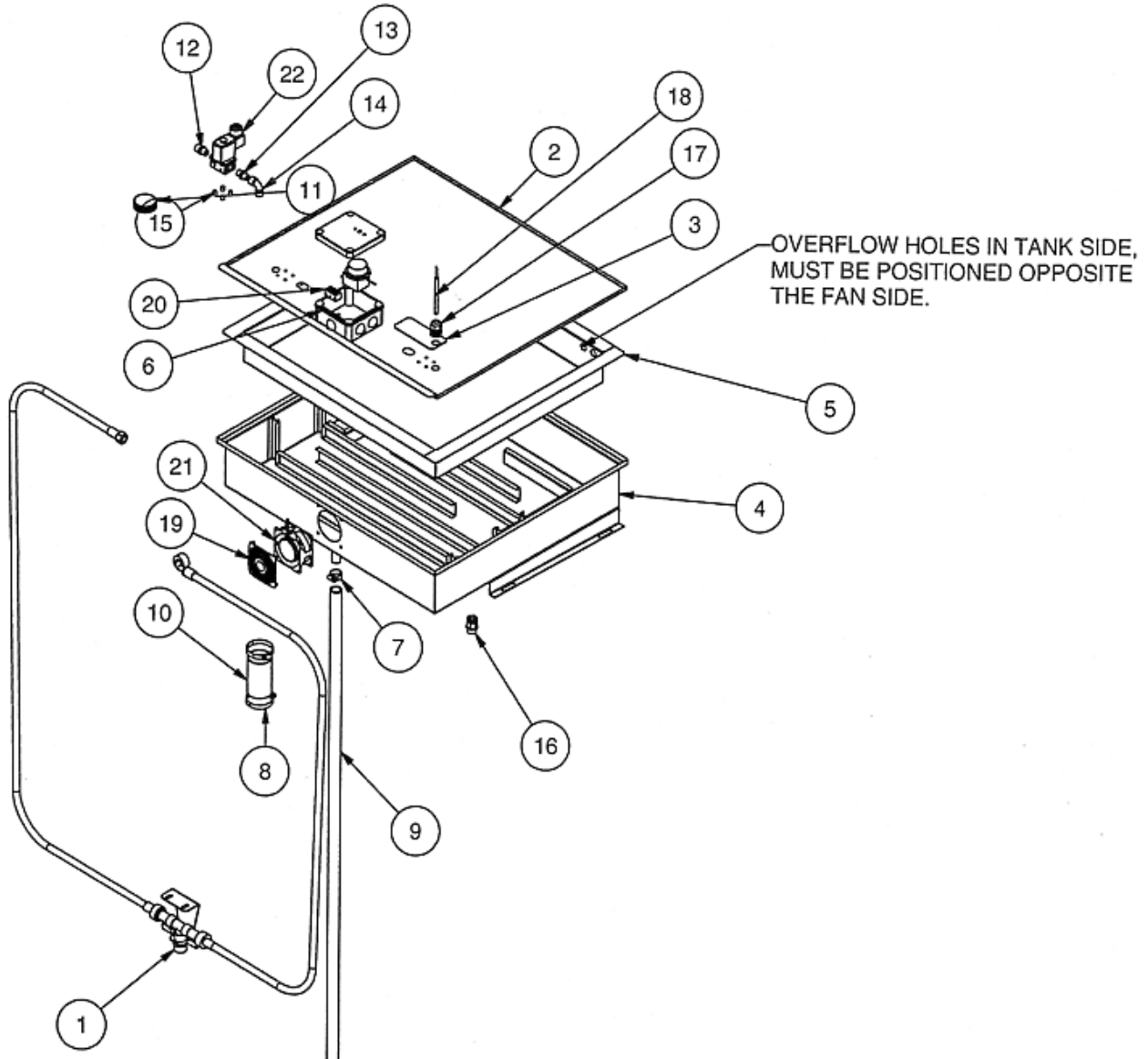

Item	Part number	Description	Quantity
1	150-07-01300	Inlet water control unit	1
2	150-19-01700	Top sheet	1
3	150-19-02300	Cover plate	1
4	150-19-02600	Base tray	1
5	150-19-02700	Water tank	1
6	150-25-07100	Junction box	1
7	A900-01-196	Jubilee clip	1
8	A900-01-271	Jubilee clip (40 to 60 mm)	2
9	A900-23-004	Drain tube (2 metres)	1
10	A900-23-027	Flexible tube (duct hose)	1
11	A900-27-187	Plug insert	1
12	A900-34-191	Reducer 1/4-in. BSP (male) x 3/8-in. BSPT (male)	1
13	A900-34-244	Reducer 1/4-in. BSP (male) x 1/4-in. BSPT (male)	1
14	A900-34-245	Elbow	1
15	B811-33-001	Spacer	4
16	B839-17-003	Cable gland type 251	1
17	B842-17-005	Cable gland type 206-6096	1
18	B842-30-003	Thermostat	1
19	B842-40-002	Fan guard	1
20	B842-50-005	Porcelain connecting block	1
21	B869-75-033	Fan	1
22	B867-83-011	Solenoid valve	1



## Other versions of the condenser that may be fitted

The following evaporation design versions could be fitted to your oven. They only require to be plugged into the socket at the rear of the oven ([Figure 45](#)). This connection powers the fan and evaporation pad. No drain is required.

**Figure 46:** Plugging in the condenser unit



Figure 47: Condenser unit FG150/AC5

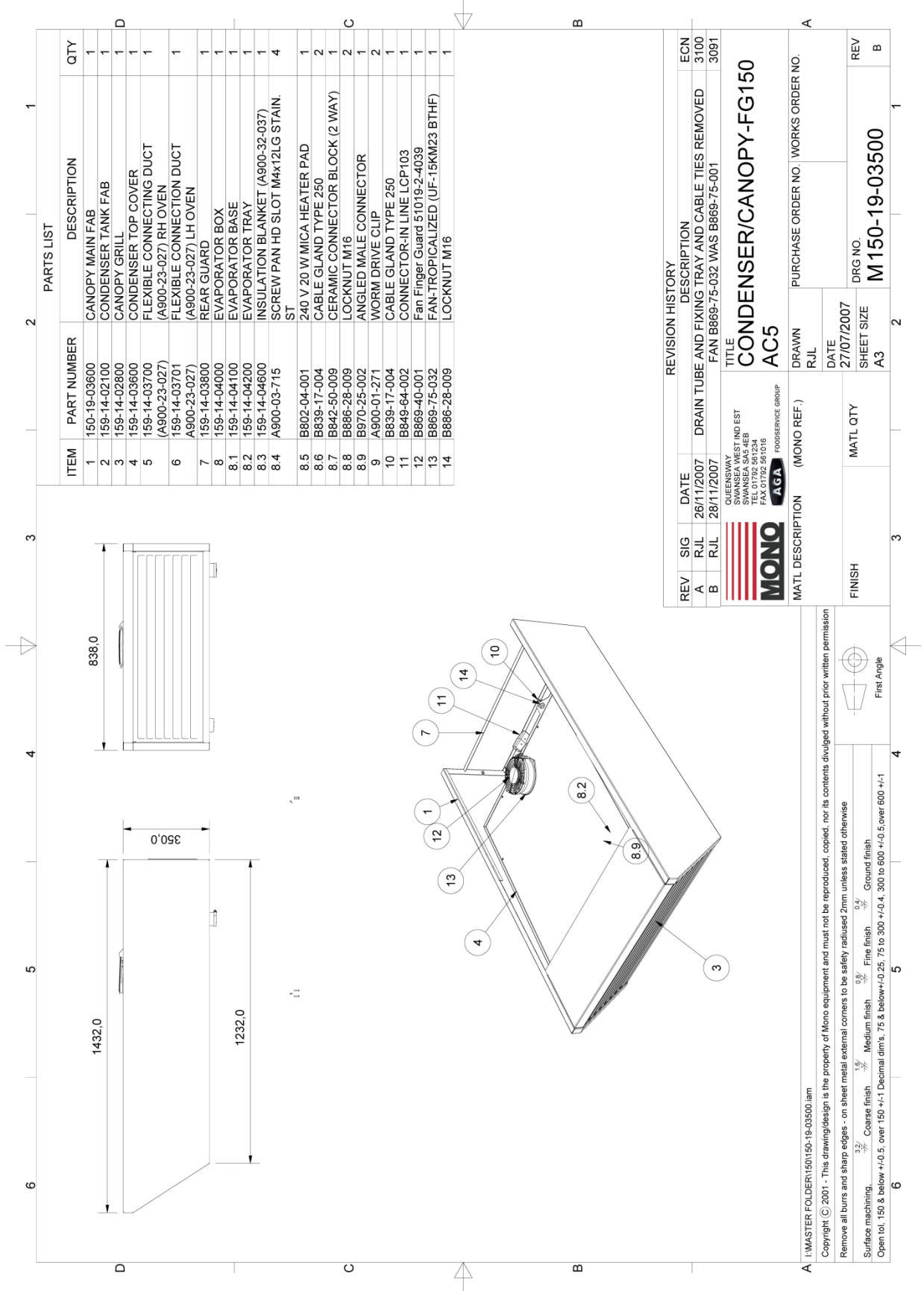

Figure 48: Condenser assembly FG155/X38

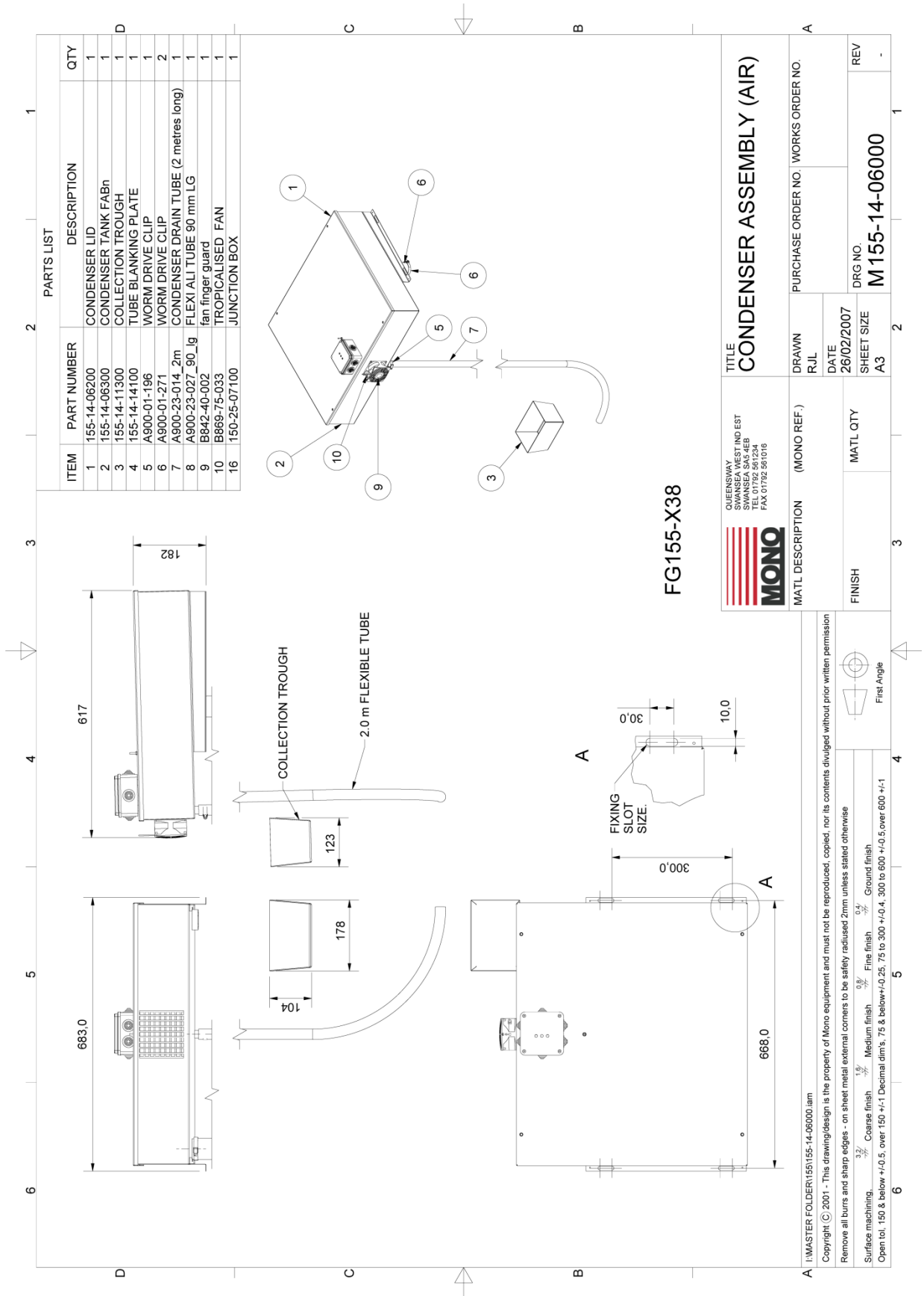

Figure 49: Condenser assembly FG158/AC1

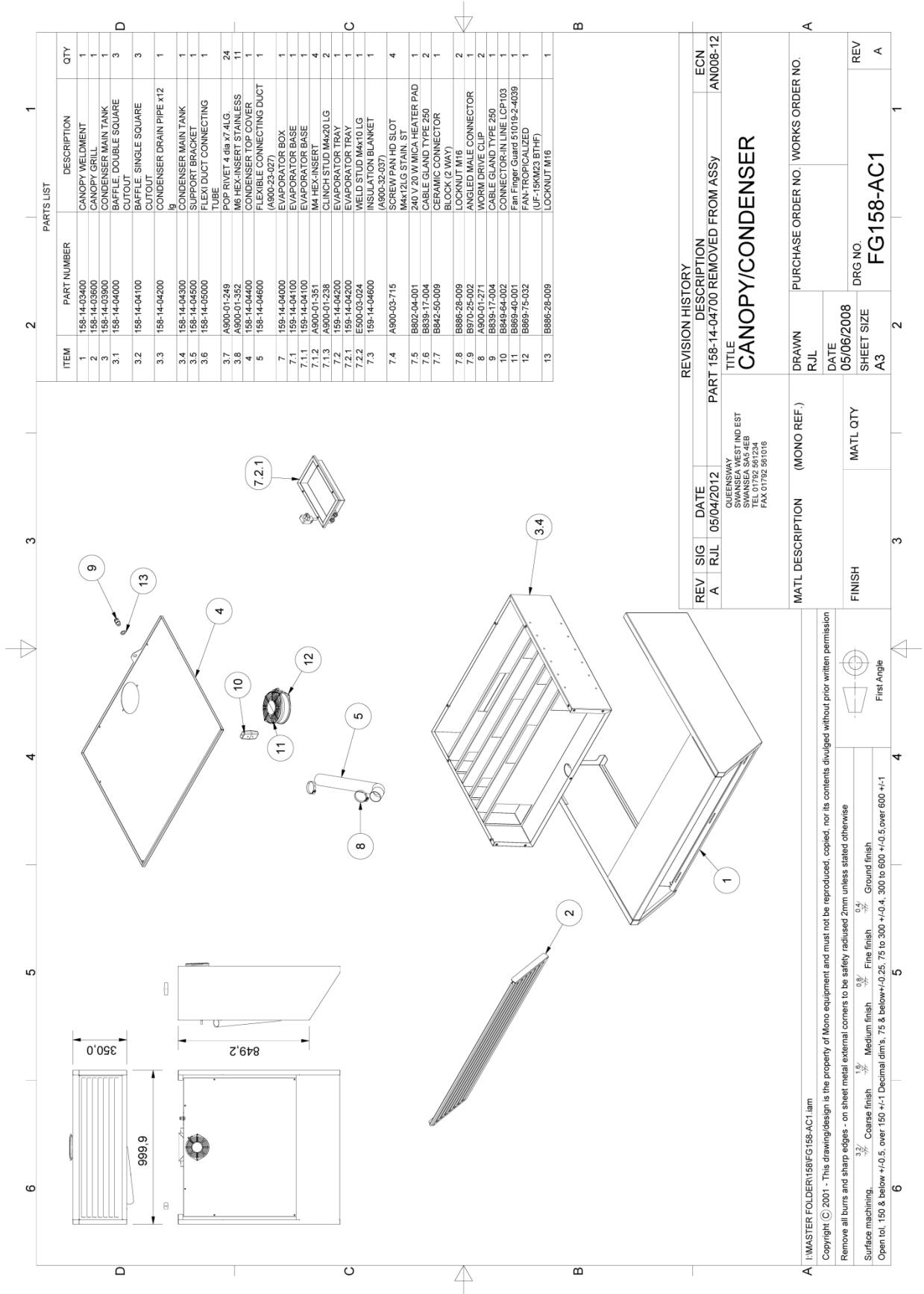

Figure 50: Reduced height condenser FG158/AC3

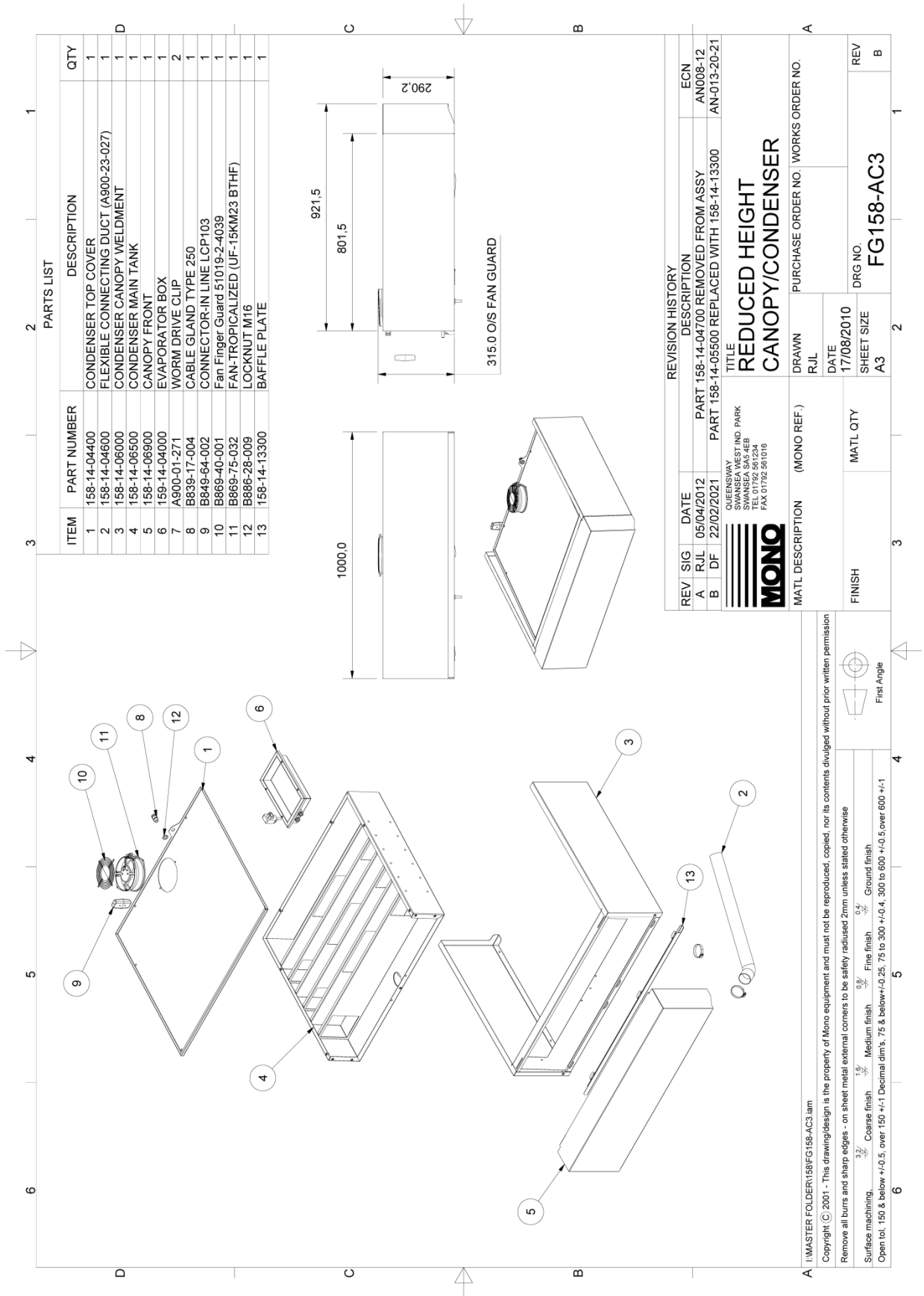

Figure 51: Reduced height condenser FG158/AC4

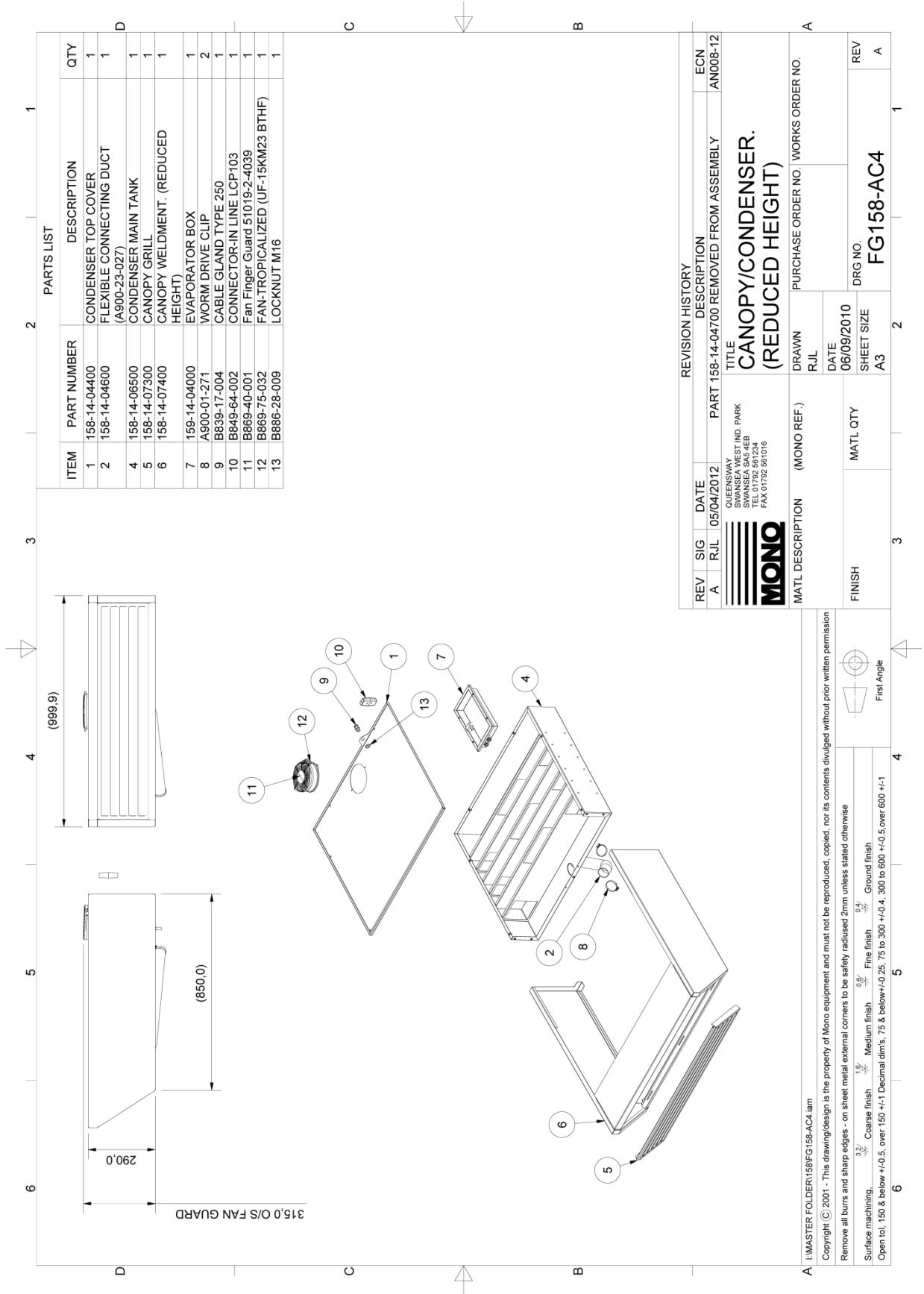
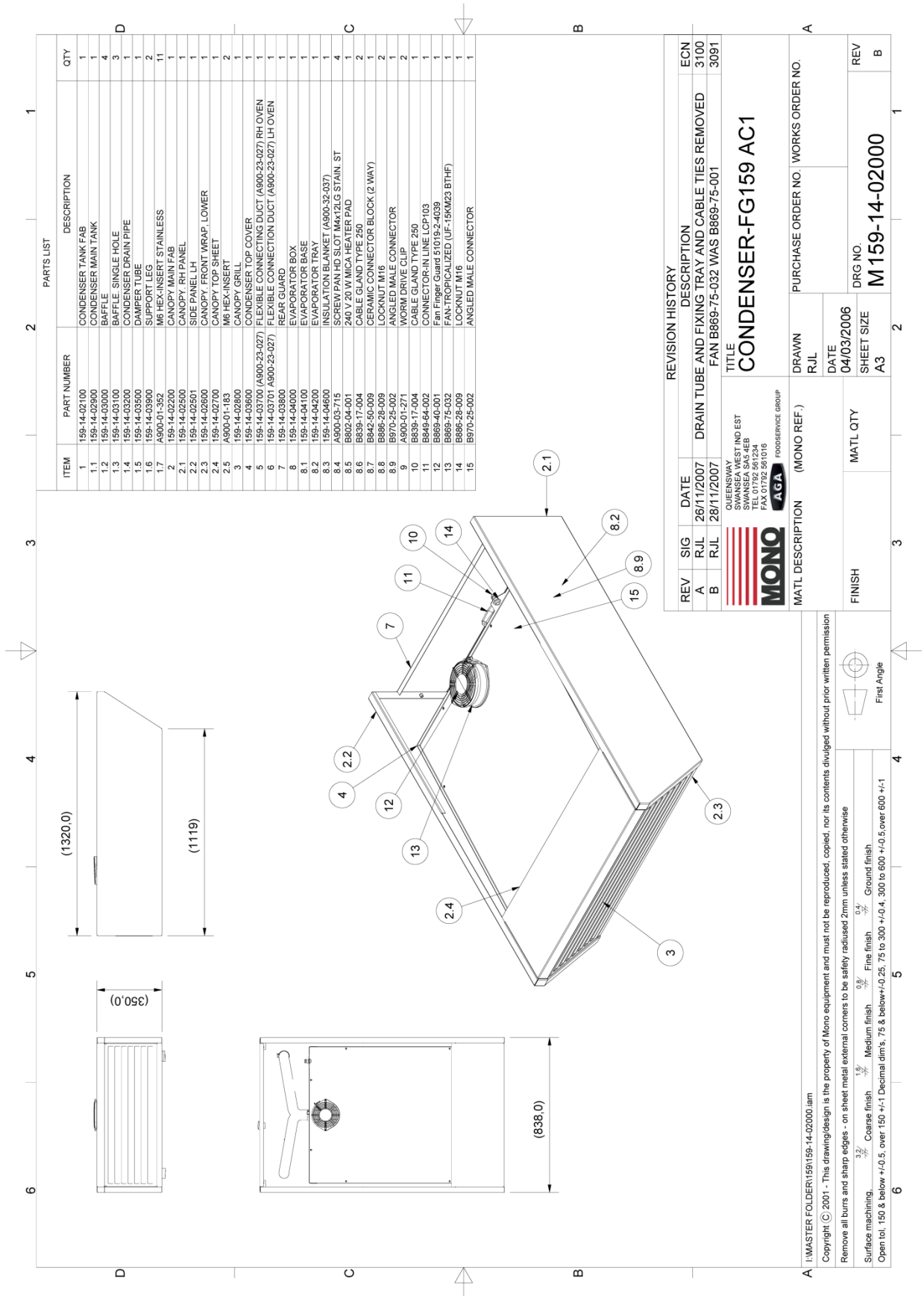

Figure 52: Condenser FG159/AC1



**(Intentional Empty Page)**



## 12. Passwords

Remove this section if tampering could be a problem.

### Passcodes

**1111** Operator access – for saving or renaming bake programs.

**2222** Oven setting access – setting time/date, etc.

**2413** High-level settings access.

---

#### NOTE

If the passcodes have been changed and are not available, contact MONO Equipment for a master number that opens all screens.

---

**(Intentional Empty Page)**



---

MONO Equipment is the leading designer and manufacturer of bakery equipment in the United Kingdom. This proud heritage of British craftsmanship, combined with a reputation for creating high-quality, innovative products, can be traced back to its origins in 1947.

All our bakery equipment is manufactured to the most stringent NQA ISO9001:2015 & NQA ISO14001:2015 standards and is crafted using the very latest, cutting-edge technology combined with the time-honoured skills of the master craftsman.

MONO Equipment truly excels in providing tailor-made solutions to a diverse range of clients, from the small independent artisan baker to the large retail chains found on every high street and in every out-of-town shopping centre. We can supply everything from a simple Food-2-Go cafe oven to the entire list of bakery equipment needed to set up a full scratch bakery.



**MONO Equipment Limited**

Queensway  
Swansea West Industrial Park Swansea  
SA5 4EB

Tel: +44 (0)1792 561 234 (Switchboard)  
Tel: +44 (0)1792 564 000 (UK Sales)  
Tel: +44 (0)1792 564 004 (International Sales)  
Tel: +44 (0)1792 564 048 / +44 (0)1792 564 049 (Spares)  
Fax: +44 (0)1792 561 016

Email: [sales@monoequip.com](mailto:sales@monoequip.com)  
web: [www.monoequip.com](http://www.monoequip.com)



*Scan using your smart phone to view our website.*

