

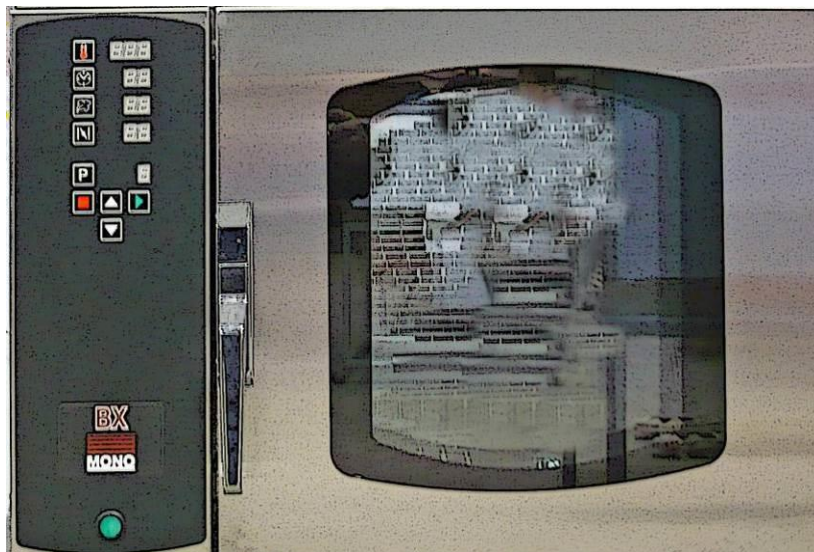

www.monoequip.com

OVEN SERIAL NO. _____
OVEN CODE 149 150 153 156 158 159 180

CONDENSER SERIAL No. _____ (IF FITTED)
In the event of an enquiry please quote these numbers.



Bx OVEN

SET UP AND OPERATION OF OVEN AND CONDENSER UNIT (IF FITTED)

CLASSIC

Failure to adhere to the operation, cleaning and maintenance instructions detailed in this manual could affect the warranty of this oven.

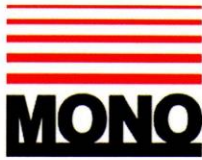

DECLARATION OF CONFORMITY

We hereby declare that this machine complies with the essential health and safety requirements of :-

- The Machinery Directive 2006 / 42 / EC
- The Low voltage Directive 2006 / 95 / EC
- The requirements of the Electromagnetic Compatibility Directive 2004 / 108EC, 91 / 263 / EEC, 92 / 31 / EEC
- The General Safety of Machinery and food processing Standards applicable
- Materials and Articles intended to come into contact with food - Regulation (EC) No. 1935 / 2004
- Good manufacturing practice for Materials intended to come into contact with food - Regulation (EC) No. 2023 / 2006

Signed	
G.A. Williams – Quality Manager	

Date	
-------------	--

Machine FG Code.		Machine Serial No.	
-----------------------------	--	-------------------------------	--

A technical construction file for this machine is retained at the following address:

MONO EQUIPMENT
Queensway,
Swansea West Industrial Park,
Swansea
SA5 4EB
UK

MONO EQUIPMENT is a business name of **AFE GROUP Ltd**
Registered in England No.3872673 VAT registration No.923428136

Registered office: Unit 35,
Bryggen Road,
North Lynn Industrial Estate,
Kings Lynn Norfolk,
PE30 2HZ

ATTENTION

IF OVEN FAILS TO HEAT UP, WHEN FIRST CONNECTED TO A POWER SUPPLY OR DURING USE AT ANYTIME, PRESS RESET BUTTON(S) LOCATED THROUGH THE REAR BACK PANEL. (DO NOT REMOVE BACK PANEL)

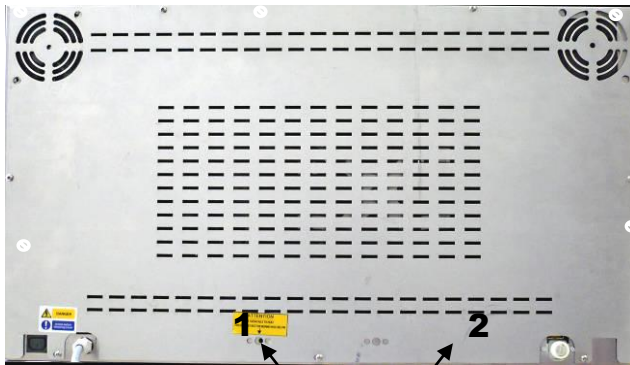

**4 TRAY OVEN
HOLE LOCATION**

*HOLE CAN BE AT POSITION 1 OR POSITION 2
DEPENDING ON OVEN*

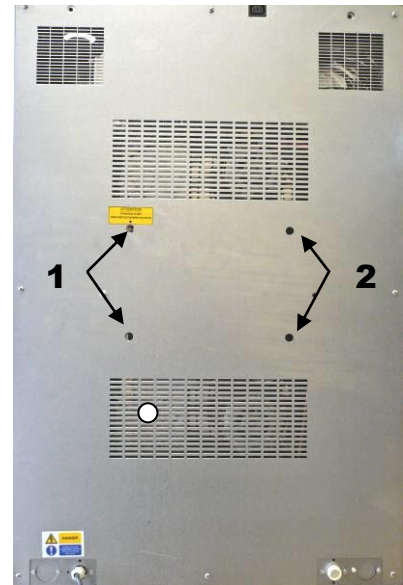

**10 TRAY OVEN
HOLE LOCATION**

*HOLES CAN BE AT POSITION 1 OR
POSITION 2
DEPENDING ON OVEN*



**2 TRAY OVEN
HOLE LOCATION**

REAR VIEW OF OVENS

IF THIS FAILS TO CORRECT THE SITUATION, PLEASE CONTACT YOUR SUPPLIER

CONTENTS

PAGE

PART 1.0	Introduction	5
PART 2.0	Specifications	6
PART 3.0	Safety	7
PART 4.0	Installation	8
PART 5.0	Isolation	9
PART 6.0	Daily / Weekly Cleaning	10
PART 7.0	Ideal Operating Conditions	12
PART 8.0	<u>CLASSIC Operation</u> Running preset programs	13
PART 9.0	Programming Creating and changing program values	15
PART 10.0	Maintenance	18
PART 11.0	Steam System Maintenance	18
PART 12.0	Light Bulb Replacement	18
PART 13.0	CONDENSER INFORMATION (IF FITTED)	19
	<i>SERVICE / SPARES</i> Contact Information	38

1.0 INTRODUCTION

- A combination of clean industrial design and the latest technology, the **MONO BX oven range** is designed specifically to take the baking Industry's standard trays.
- The ovens in the range are of **stainless steel construction** and some have removable tray racks to aid cleaning.
- The smaller ovens are designed to be **stackable** without separate support, so your business can grow without taking up more ground space.
- The high-speed fans, elements and steam systems give **efficient air circulation** to produce a professional bake across a range of products.
- The doors are **double glazed** to increase the efficiency of the ovens well-insulated baking chamber
- Ovens are fitted with **LED (classic)** displays for the user-friendly control panels.

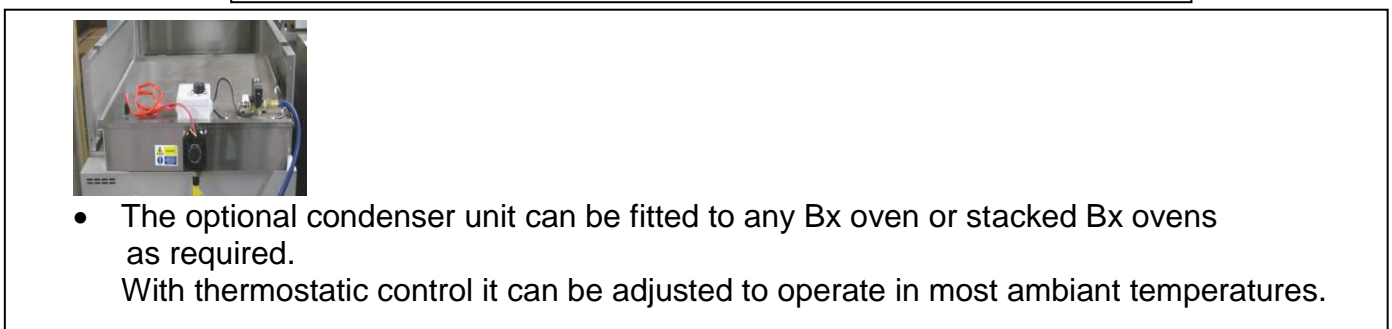
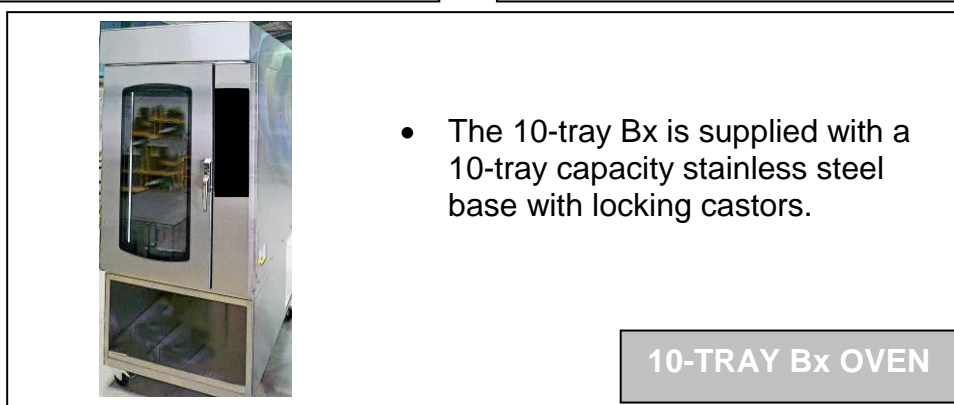
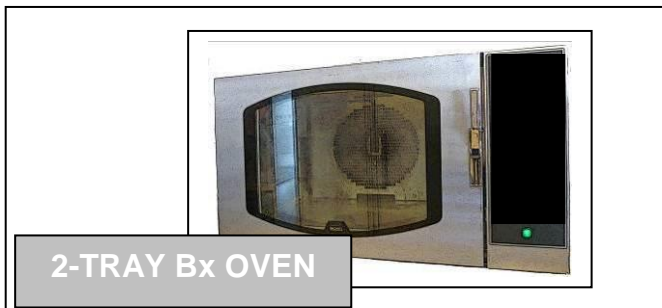

2.0 SPECIFICATIONS

Technical Specifications



eco-touch Model No	2 Tray				4/5 Tray				10 Tray					
	FG156T	FG189T	FG159T	FG153T	FG158T	FG173T	FG180T	FG150T	FG149T	FG170T	FG180C	FG150C	FG149C	FG170C
Classic Model No	FG156C	FG189C	FG159C	FG153C	FG158C	FG173C	FG180C	FG150C	FG149C	FG170C	FG180C	FG150C	FG149C	FG170C
Tray size (mm unless otherwise stated)	600 x 400	18" x 26"	18" x 30"	400 x 600	600 x 400	400 x 800	18" x 26"	18" x 30"	400 x 600	400 x 800	18" x 26"	18" x 30"	400 x 600	400 x 800
No of trays	2	4	4	3	4	4	10	10	10	10	10	10	10	10
Distance between trays (mm)	90	93	93	93	84	93	100	100	100	100	100	100	100	100
No of trays (option)		5	5	5	5	5								
Distance between trays (option, mm)		74	77	69	62	70								
Height (mm)	420	525	525	525	570	525	1,170	1,170	1,170	1,170	1,170	1,170	1,170	1,170
Height of oven on base (mm)							1,870	1,870	1,870	1,870	1,870	1,870	1,870	1,870
Width (mm)	1,000	840	840	780	1,000	780	840	840	840	840	840	840	840	840
Depth, door closed incl handle (mm)*5	732	1,164	1,269	1,103	890	1,303	1,209	1,309	1,109	1,309	1,209	1,109	1,309	1,309
Depth, door fully open (mm)*5	1,062	1,729	1,828	1,610	1,610	1,810	1,770	1,870	1,609	1,870	1,770	1,609	1,870	1,809
Weight (kg) approx.	66	145	165	115	110	160	192	290	250	262	192	290	250	262
Total power required (kW)	3	7.5	8.5	7.5	7.5	7.5	17	17	15	17	17	17	15	17
Water Supply	2	2	2	2	2	2	2	2	2	2	2	2	2	2
Modularity														
Landscape tray orientation														
Portrait tray orientation														
Eco-Touch controller														
Classic Controller														
Right hand hinged														
Left hand hinged														
Bottom door hinged														
Power - 1 phase electrics	1	3	3	3	3	3	3	3	3	3	3	3	3	3
Power - 3 phase electrics	4	4	4	4	4	4	4	4	4	4	4	4	4	4
Steam facility														
Internal Light														
Stackable														
Optional Extras:														
Calcium Treatment Unit														
Water Condenser														
Valance														
300mm high base														
595mm high base														
745mm base unit														
920mm high base														
Ovens Suitable For:														
UK														
Europe														
Commonwealth														
USA & Canada														
ROW														

Available **Optional Extra**

- 1 50Hz; total load 2.99kW. Plug top fused at 13 Amps
- 2 Oven is supplied with a 1 metre long flexible hose with 3/4" B.S.P. female connectors on both ends. Water pressure required is **2 bar - 4 bar** (standard domestic water pressure is within these parameters). Customers are strongly advised to fit a water conditioning unit to the supply for this equipment. This unit should remove and not suspend water hardness. No drain is required for this oven. See Optional Extras for water conditioning unit.

3 50Hz; fused at 40 Amps. Single phase ovens will be supplied with LEGRAND model 587-00 plug fitted to 2.5 metres of cable. Customers should ensure that a LEGRAND model 587-40 socket (or equivalent), and isolator is fitted at the position of installation.

4 50 Hz; fused at 15 Amps per phase. Three phase ovens are supplied with a single LEGRAND model 574-29 plug fitted to 2.5 metres of cable. Customers should ensure that a LEGRAND model 0553-53 socket (or equivalent), and isolator (or model 0592-11 'dead fronted') is fitted at the position of installation.

5 3 phase and neutral + earth; fused at 32 Amps; 415v; 50 Hz. Customers should ensure that a LEGRAND model 0553-53 socket (or equivalent), and isolator (or model 0592-11 'dead fronted') is fitted at the position of installation.

*5 excluding services

Please contact MONO Equipment for USA electrical details.

Specifications correct at time of publication. MONO Equipment reserves the right to amend the specification without prior notice.

3.0 SAFETY

In the interest of safety and efficient operation of the oven, it is essential that this manual should be made available to the operator before work is commenced. The following points should be observed and followed at all times.

1. The oven is designed for baking of bread, confectionery and savoury products only. **DO NOT** use it for any other items without consulting with **MONO**.
2. The oven must be allowed to cool before any form of cleaning is started.
3. All repairs and maintenance of electrical units must be carried out by authorised electricians; even then, electrical access panels must not be opened unless the mains supply to the oven is isolated.
4. All connections to the oven must be made in accordance with the statutory requirements of the country of installation.
5. While the oven is in operation (and for some time after use), **it is inadvisable to touch the oven window or the surrounds because of conducted heat.**
6. The oven must be operated as described in this manual.
7. Only **MONO** spare parts should be used on this oven.
8. The construction of the oven must not be changed.
9. The owner of the oven is legally obliged to instruct staff of these safety points and of the safe operation of the oven. **These instructions should not be removed from the working area.**
10. To prevent door glass from shattering - **DO NOT CLEAN OVEN GLASS WHEN HOT.**
11. Customers operating a BX oven in a hard water area must ensure that an efficient water-softening device protects the water supply to the equipment.
12. Oven gloves should be worn when moving products in or out of the oven.

ATTENTION

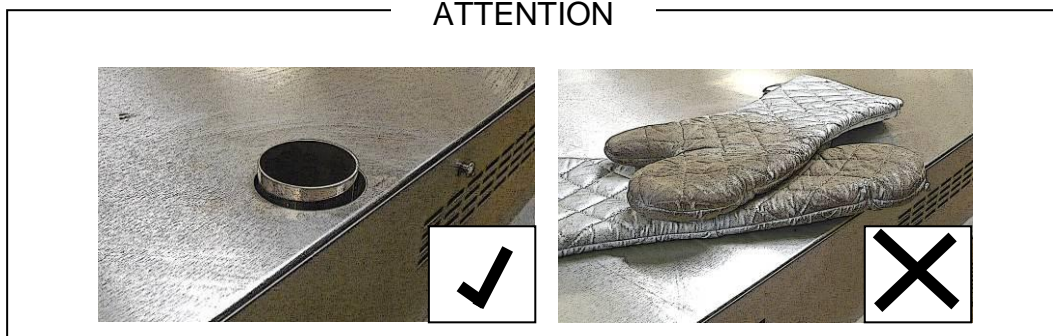

4.0 INSTALLATION

1. The oven should be connected to a wall isolator.

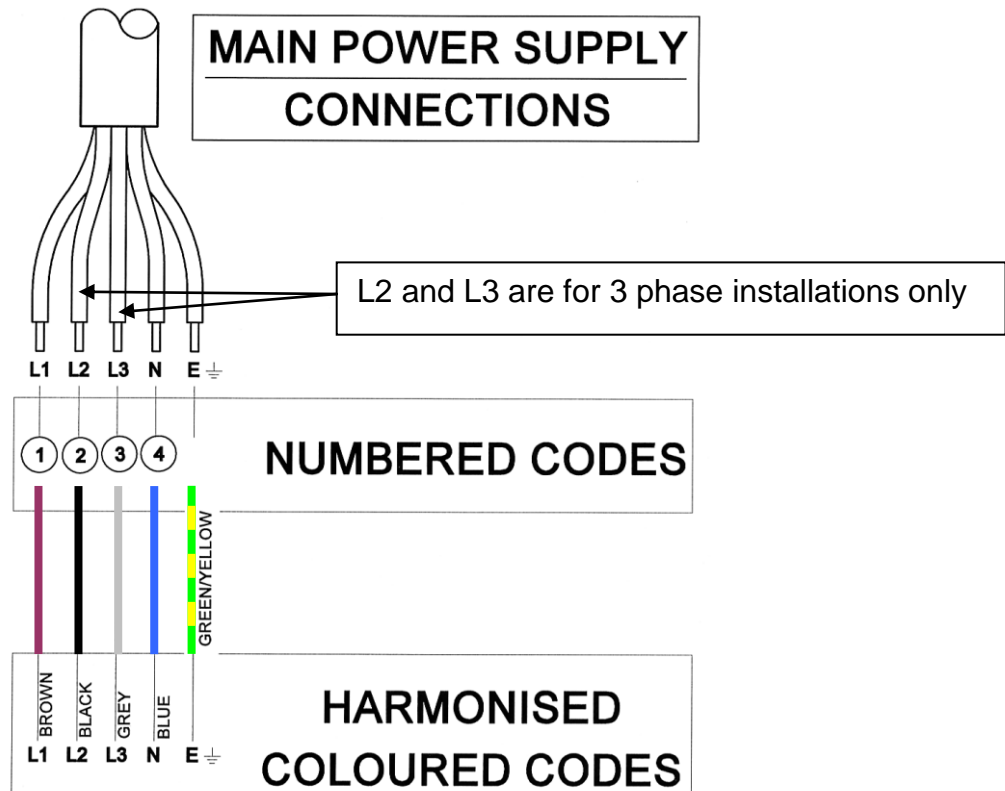

2. It is the customers' sole responsibility to arrange adequate ventilation and it should be sufficient to ensure water does not condense on or around the oven. A 50mm gap is required at the sides and rear of this oven. Chimneys and evacuation ducts, fitted above mono ovens should be insulated.
3. If an oven with steam has been chosen, connect to a suitable water supply making sure that the pipes are flushed out to remove all foreign bodies i.e. flux or solder. Customers in hard water areas must ensure that an efficient water treatment device protects the supply to the oven. It is the customers' responsibility to install and maintain an adequate water supply to the oven, which should comply with local water regulations.
4. In the interests of hygiene, we strongly recommend that before using the oven for the first time you wipe the inside of the oven and all accessories thoroughly with a clean cloth soaked in warm soapy water. Although the utmost care is taken during assembly and pre-delivery inspection, there is always a possibility of residue contaminating the first bake if this is not done.
5. Ensure that the locking castors on the base unit (if supplied) are locked into position.
6. **AMBIENT WORKING TEMPERATURES.**
Ambient working temperatures for electric/electronic components such as solenoid switches, circuit breakers, motors etc should be **no more than 40°C (115° f)**
Manufacturers of these and other electrical components advise that any ambient temperature above 40 °C affects the functionality of the components and any related guarantees become void. For example, above this temperature motors are not satisfactorily cooled, contactor efficiency is seriously impaired and electronic components shut down. It is the customers' sole responsibility to arrange for adequate ventilation. Any component malfunctioning during the guarantee period that is found to have been subject to excessive humidity or ambient working temperature above 40°C (115°F) will not be covered by the component manufacturers guarantee or MONO's product warranty.

5.0 ISOLATION

ELECTRICITY SUPPLY

To stop the oven in an emergency, switch off electricity at the wall isolator.

WATER SUPPLY

For stacked ovens, the water supply can be shut off by closing the shut-off valves (See diagram)

For non-stacked ovens the water supply should be shut off at the nearest shut-off point

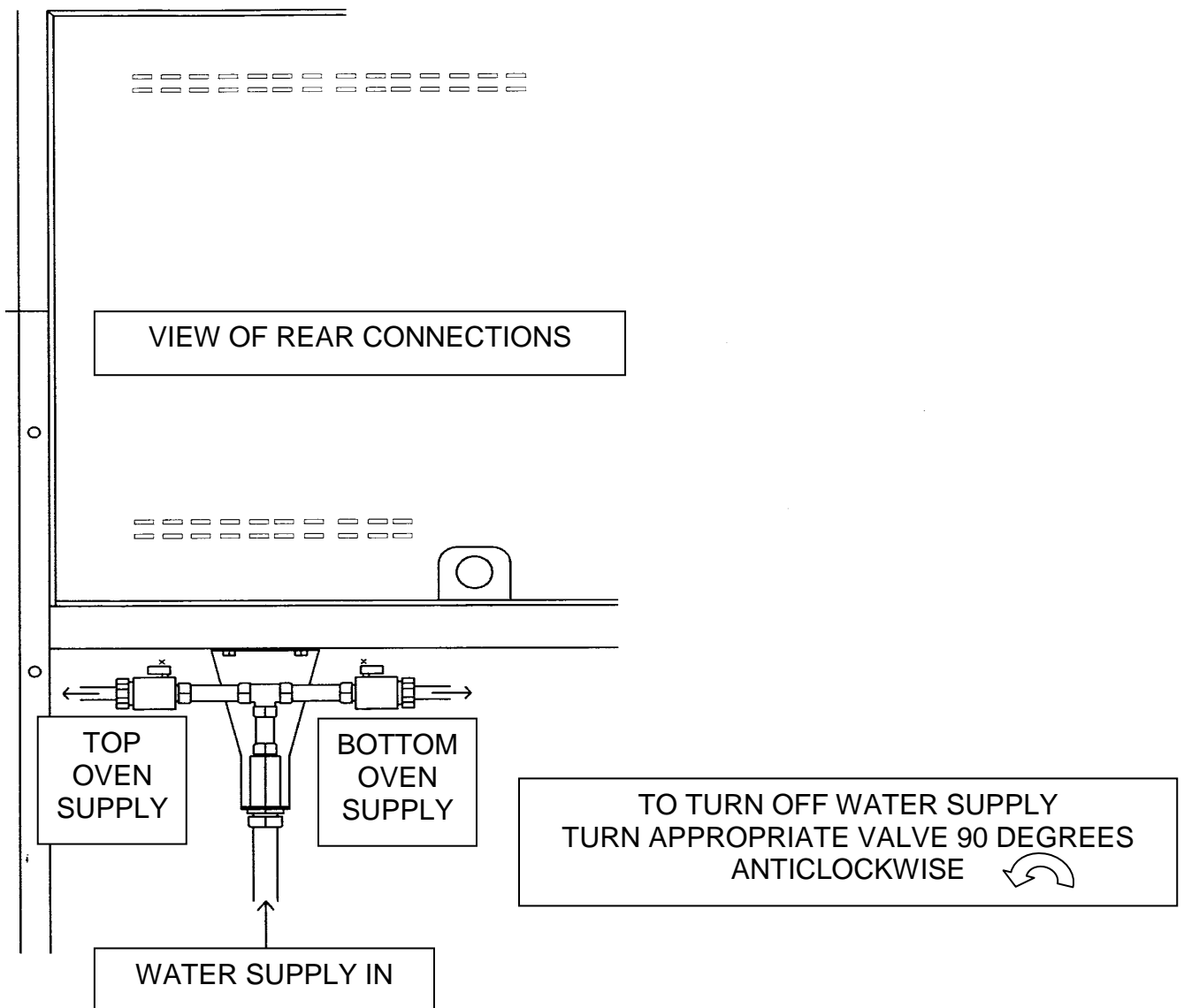

6.0 CLEANING INSTRUCTIONS

DAILY

**NOTE: BEFORE CLEANING,
ISOLATE OVEN FROM MAINS SUPPLY AND ALLOW TO COOL.**

- The equipment is to be cleaned daily using approved chloride-free cleaning fluid
- Sweep any debris (after it has been allowed to cool) onto oven removable trays and remove for cleaning.
- Brush down and wipe oven front, back and sides.
- Wipe clean with a damp cloth that has been soaked in a solution of mild detergent and hot water.

IMPORTANT:

**TAKE CARE WATER DOES NOT ENTER CONTROL PANEL OR
REAR ACCESS PANEL.**

**DO NOT REMOVE THE REAR PANELLING INSIDE THE OVEN.
THIS ALLOWS ACCESS TO THE FAN ASSEMBLY WHICH IS NOT SAFETY
INTERLOCKED AND COULD CAUSE INJURY**

WEEKLY

**NOTE: BEFORE CLEANING, ISOLATE OVEN FROM MAINS SUPPLY
AND ALLOW TO COOL.**

Complete daily check then

- Clean any burnt-on debris by careful use of a proprietary oven cleaner, carefully following the manufacturer's instructions. Do not allow the oven cleaner to get onto the control panel.
- Scrub cabinet wheels (if fitted), with a mild detergent and hot water using nylon cleaning brush.

Ovens using 60cm x 40cm trays (FG156 2 tray / FG158 4 tray)

Open the oven door and remove internal racking from sides of oven.
(*lift and unlatch racking*).

This allows access to hidden areas in the oven, which can be wiped with a damp cloth.

Wipe down, and clean racking with a damp cloth and replace.

4 tray ovens

The inner door glass is hinged to enable cleaning of internal surfaces.

To open, remove the two screws shown in the sketch below.

The internal surfaces of the door glass can then be cleaned using a suitable glass cleaner.

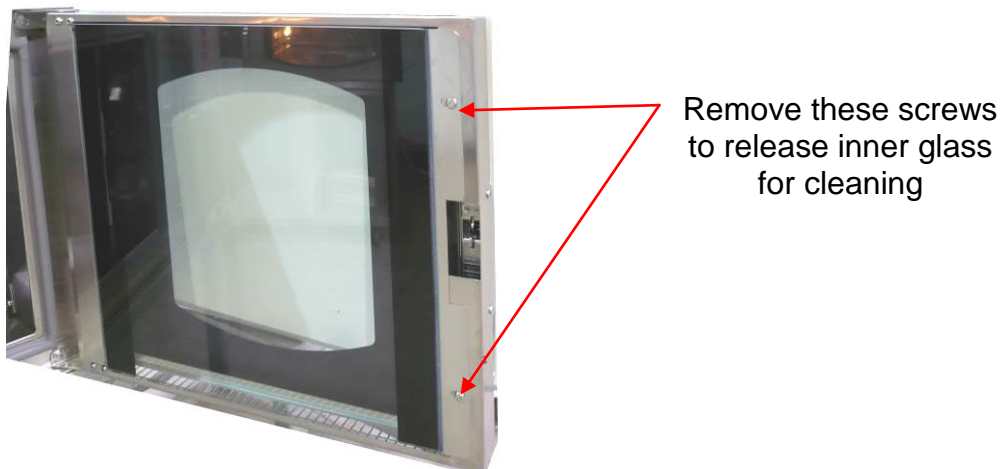

7.0 IDEAL OPERATING CONDITIONS ---

- Room should be allowed for the door to open fully to allow easy loading and unloading of product without people coming in contact with hot surfaces.
- Racks should be available to allow cooked products to cool safely.
- Oven gloves should be available at all times.
- It is the customers' sole responsibility to arrange adequate ventilation and it should be sufficient to ensure water does not condense on or around the oven. A 50mm gap is required at the sides and rear of this oven.
- Chimneys and evacuation ducts, fitted above mono ovens should be insulated

AMBIENT WORKING TEMPERATURES.

Ambient working temperatures for electric/electronic components such as solenoid switches, circuit breakers, motors etc should be **no more than 40°C (115° f)**

Manufacturers of these and other electrical components advise that any ambient temperature above 40°C affects the functionality of the components and any related guarantees become void. For example, above this temperature motors are not satisfactorily cooled, contactor efficiency is seriously impaired and electronic components shut down. It is the customers' sole responsibility to arrange for adequate ventilation. Any component malfunctioning during the guarantee period that is found to have been subject to excessive humidity or ambient working temperature above 40°C (115°F) will not be covered by the component manufacturers guarantee or MONO's product warranty.

BX CLASSIC

Operating Instructions

Section 8

8.0 BX'CLASSIC' OPERATING INSTRUCTIONS

RUNNING PRE-SET PROGRAMS

REFER TO CONTROL PANEL (SEE RIGHT)

- 1 **Switch on power** by pressing green button (1).
- 2 **Select required program** using **UP/DOWN** scroll keys (2).
- 3 **Press START** key (3) to begin bake cycle.
 - Oven will heat to set temperature and display will flash actual temperature.
 - **When set temperature is reached** the display will stop flashing. The oven is now ready
- 4 **Load product.** Close door.
- 5 **Press START** key (3).
Display will show the following:-
 - (9) • Actual temperature.
 - (8) • Remaining bake time in minutes.
Display will automatically switch to show remaining seconds during the last minute of bake time.
 - (7) • Steam time (if set) in seconds.
If the actual temperature is less than the minimal steaming temperature of 125 C then '--' will be displayed. This indicates that steaming functions are inhibited.
 - (6) • Damper duration (delay before open) in minutes.
 - (5) • Program number/bake cycle indicator.
Display will alternate between program number and the spinning bake cycle indicator.
- 6 Press **STOP** key (4) when “bake over” alarm sounds

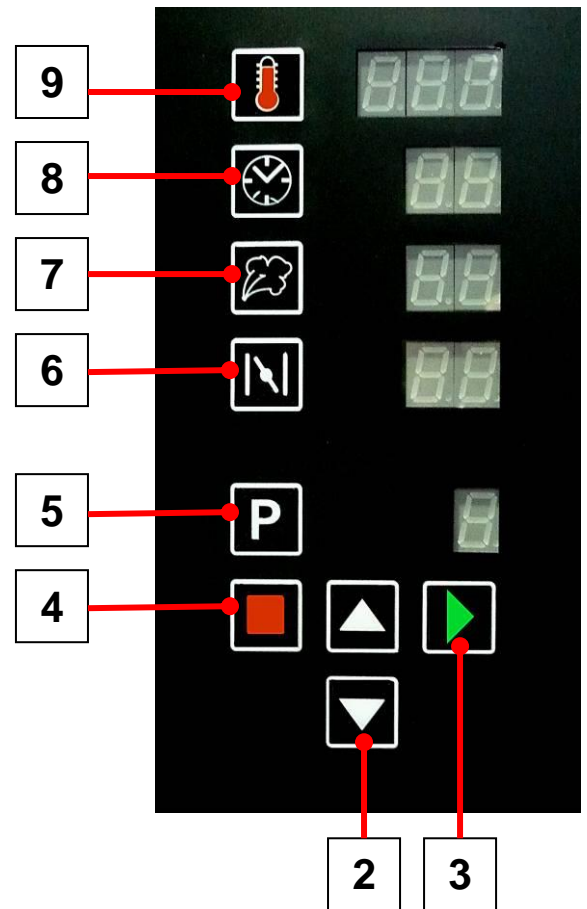

9.0 BX 'CLASSIC' PROGRAMMING INSTRUCTIONS

CREATING PROGRAMS/CHANGING PROGRAM VALUES.

Pre-set values for bake temperature; bake time, steam and (optional) damper may be modified at any point.

CREATING/CHANGING PROGRAM VALUES

1. **Switch on power** by pressing green button (1).

2. Use the UP/DOWN arrow keys (2) to select a program to change

3. Press the key associated with the change required (*temperature (9), time (8), steam (7), damper (6)*). A selection indicator will flash in the right hand side of the selected window.

4. Use up/down arrow keys (2) to modify the value

The operator now has the option to save the changes, or run the program with temporary values.

If the operator chooses not to save the modifications, then the program will reset to its original values upon reselection.

5. Press START (3) to bake (see next page for further baking instructions)

or save the values as follows

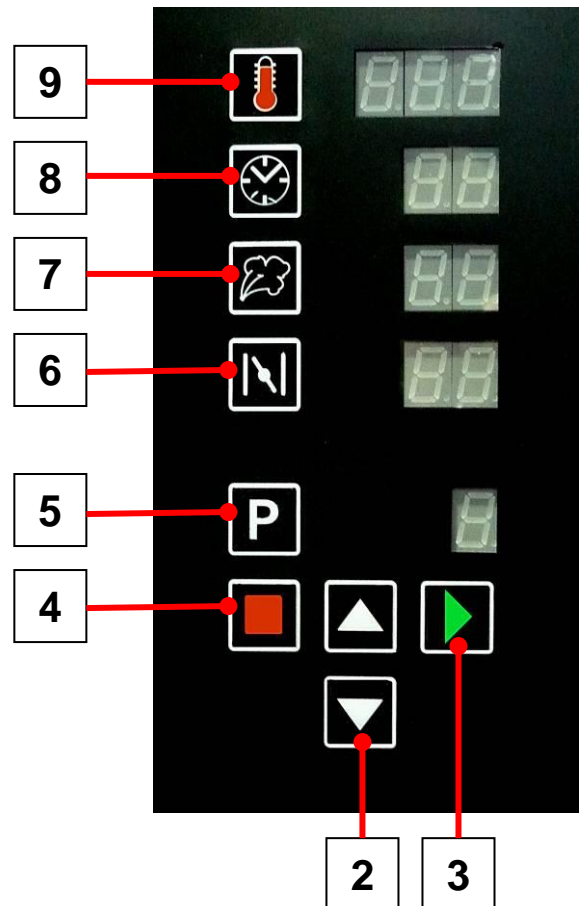

SAVING PROGRAM VALUES

6. Press and hold the **P** key (5) for 5 seconds. *During this time, all displayed values will flash. The controller will beep at the end of this period to acknowledge the program save.*

Note:

Programs cannot be saved during a bake cycle.



SETTING PREBAKE TEMPERATURE (if enabled)

Press (9). (one dot flashes)
Press (9) and hold for 3 seconds (3 dots flash).
Use up/down arrow keys (2) to set temperature.
Press (9) to save

Pre-set values for bake temperature; bake time, steam, sleep mode etc. may be modified at any point.

FAN DELAY ENABLING

NOTE: This facility is only functional on a 3 phase oven.

If it is activated on a 1 phase, the fan will stop.

Hold the **P** key (5), together with the **STOP** key (4) for 5 seconds.

Press start (3) - "FAN" is displayed

press (8) to change to 00 (disable) or 01 (enable)

press up/down (2) to change next display to between 00 and 60 seconds

00 = no delay 60= 60seconds delay

OVEN PREBAKE ENABLING

Hold the **P** key (5), together with the **STOP** key (4) for 5 seconds.

or if already done for above setting, continue by

pressing start 3 - "Prb" is displayed

Press (8) to show "- 0" for disabled or again to show "-1" for enabled.

CHANGING TEMPERATURE FROM C TO F

Hold the **P** key (5), together with the **STOP** key (4) for 5 seconds.

or if already done for above setting, continue by

pressing start (3) - "F" OR "C" is displayed

Press arrow key (2) to change this.

SLEEP MODE ENABLING

Hold the **P** key (5), together with the **STOP** key (4) for 5 seconds:

or if already done for above setting, continue by

pressing start (3) - "Slp" is displayed

press up/down (2) to change next display to between 00 and 60

00 = disabled 1-60= 60 minutes delay before sleep.

DAMPER

Hold the **P** key (5), together with the **STOP** key (4) for 5 seconds:

or if already done for above setting, continue by

pressing start (3) - "dpr" is displayed

press (8) to change to -0 (disable) or -1 (enable)

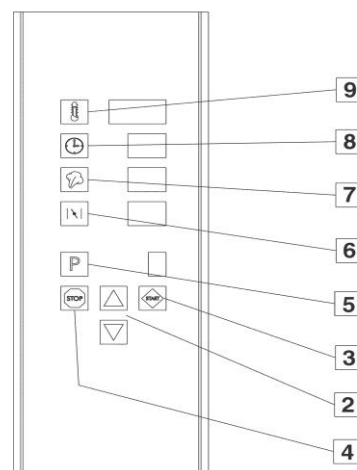

TEMPERATURE SET POINT/CHAMBER DISPLAY

Hold the **P** key (5), together with the **STOP** key (4) for 5 seconds.
or if already done for above setting, continue by
pressing start (3) - "**dsp**" is displayed
press (8) to change between "**sp**" = set point temperature displayed
or "**ct**" = chamber temperature displayed.

Pressing start (3) again sets the display back to normal operating mode.

PROGRAM "0" ENABLE (Temperature and time only control)

Hold the **P** key (5), together with the **STOP** key (4) for 5 seconds.
or if already done for above setting, continue by
pressing start (3) - "**P0E**" is displayed
press (8) to change to -0 (disable) or -1 (enable)

8 HOUR TIMER(20 minute warning of 8hrs of operation)

Hold the **P** key (5), together with the **STOP** key (4) for 5 seconds.
or if already done for above setting, continue by
pressing start (3) - "**8HR**" is displayed
press (8) to change to -0 (disable) or -1 (enable)

10.0 MAINTENANCE

- Check for frayed or bare cables.
The machine must not be used if frayed or bare cables are visible.
- Follow cleaning instructions.

11.0 STEAM SYSTEM MAINTENANCE

- If it is noticed that the steaming operation has deteriorated, perhaps due to hard water scaling, please contact your oven supplier

12.0 BULB REPLACEMENT

REPLACEMENT BULB = B857-94-007

In the event of a bulb failure, Instructions on how to change a bulb are as follows: -

- Ensure oven is isolated from mains supply and allow to cool.
- Remove screws (4 per light) and take glass, frame and gasket off lamp unit.

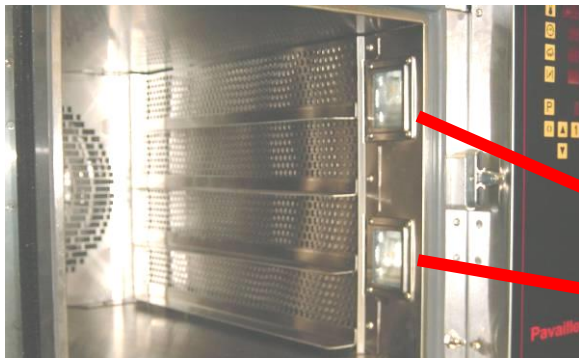

SCREWS



DO NOT TOUCH BULBS WITH BARE HANDS.
USE A CLOTH OR GLOVES TO STOP ANY MARKS THAT WILL CAUSE HOT SPOTS AND PREMATURE BULB FAILURE.

- Remove bulb by pulling in direction of arrow and replace with new bulb.

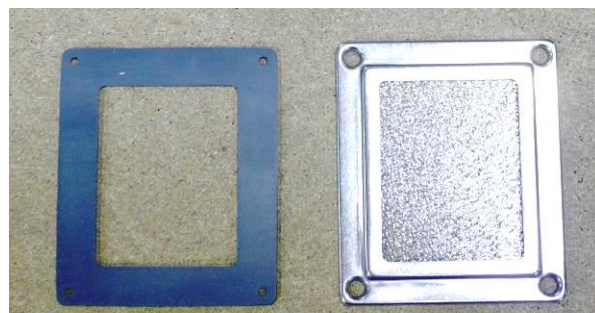

GASKET

Pt No.B721-67-008

GLASS AND FRAME

Pt No.B721-67-010

Pt No.B721-67-009

- Refit glass front taking care that gasket is in position around stainless steel frame.
Re-connect oven and test.



13

CONDENSER UNIT (IF FITTED)

All versions should be part of a regular cleaning schedule.
Water should be drained and parts cleaned with an antibacterial wash.

INDEX

INTRODUCTION	PAGE 19
DIMENSIONS	PAGE 20
SPECIFICATIONS	PAGE 21
INSTALLATION	PAGE 22
SAFETY	PAGE 24
OPERATION	PAGE 25
SPARES	PAGE 26
OTHER VERSIONS THAT MAY BE FITTED	PAGE 29
ELECTRICAL INFORMATION	SEE ELECTRICS MANUAL

INTRODUCTION

The condenser can be fitted to any Bx oven or stacked Bx ovens as required. With thermostatic control it can be adjusted to operate in most ambient temperatures. Simple water connection (washing machine type fitting) and a hose to drain are all that is required to operate efficiently.

Steam is drawn from the fluepipe of the oven through a thermostatically controlled water cooled chamber and condenses to drain away.

When the cooling water reaches a set temperature it is automatically replaced with cold water to keep the condensing process as efficient as possible.

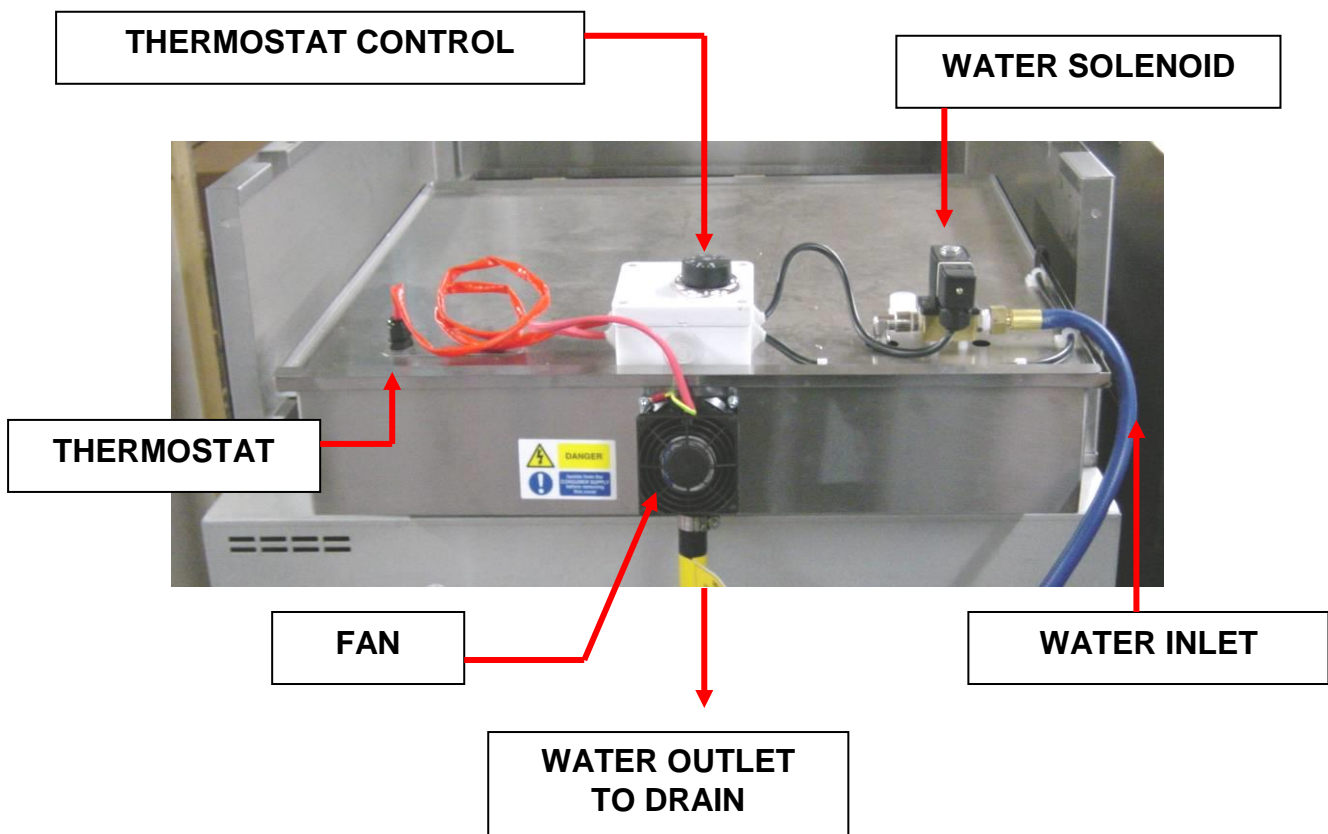

DIMENSIONS

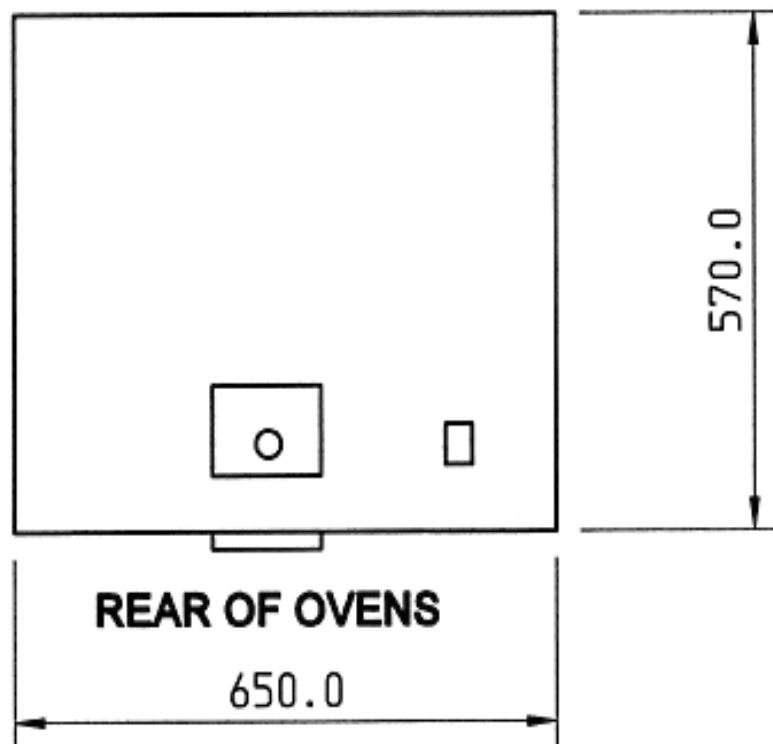
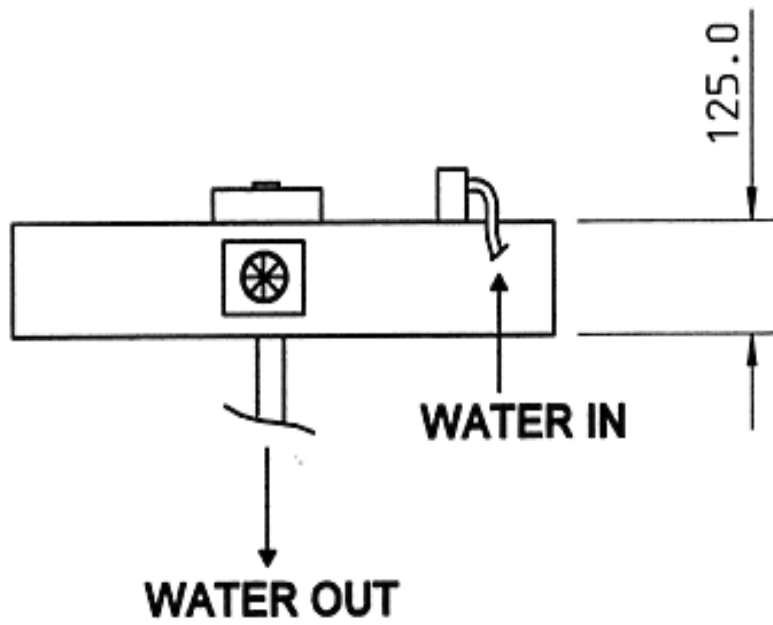

SPECIFICATIONS

POWER 230volts, 1 phase, 50hz,
21watts
Wired to oven electrical panel.

WATER Washing machine type connection to normal water supply
via steam water connection to oven(s).

NOISE Less than 85dB

WEIGHT Approx 18kg (not including water)

INSTALLATION

BEFORE INSTALLING ENSURE THAT ALL POWER IS DISCONNECTED AND THE OVEN IS COOL

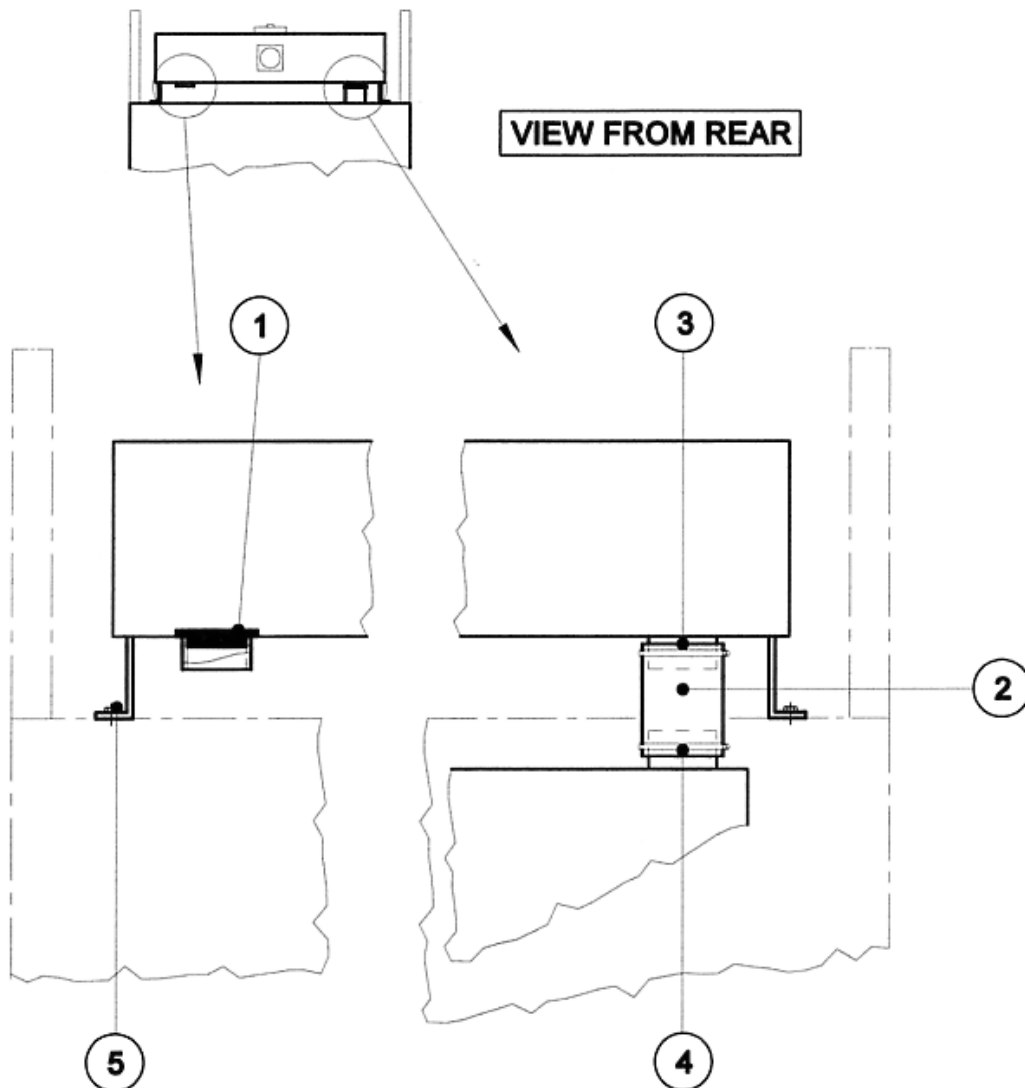

1. Before fitting the main condenser assembly, insert blanking plug **(1)** into lower hole that will not be required for the hand of oven being used.
2. Connect tube **(2)** to the spigot and retain with worm-drive clip **(3)**.

NOTE

If fixing holes are not present on the top sheet of the oven, they should be marked and drilled at this stage.

Position condenser correctly and mark hole positions (*centre of each slot*). Remove condenser and drill holes of 6.5mm diameter at 4 positions.

3. Place condenser in position ensuring that the tube **(2)** passes through the hole in the top of the oven and worm drive clip **(4)**, then over spigot of the damper assembly on the oven.
4. Tighten worm-drive clip **(4)**.
5. Fasten condenser unit to top of oven with M6 x 12mm long hex head screws and washers in 4 positions.
(If holes have been drilled, nuts will have to be used also).
6. Connect wiring, depending on whether the oven is 4 tray or 10 tray, as shown in electrical section of this manual.
7. Connect drain hose to a suitable drain.
8. Attach water tap bracket to frame of base as shown and fasten water hose to a water supply. *(A tee pipe must be used on double ovens)*

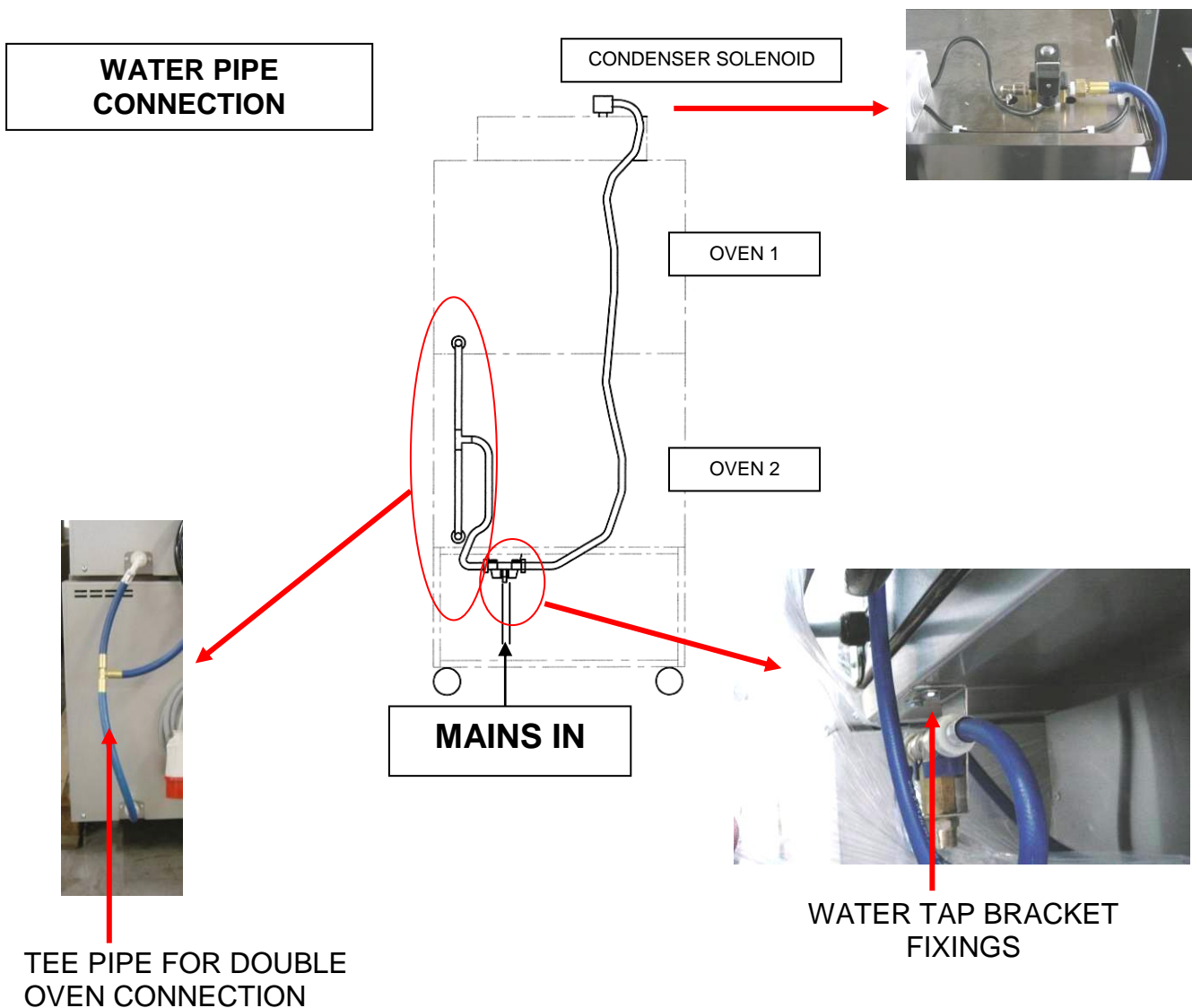

SAFETY

**BEFORE INSTALLING ENSURE THAT ALL POWER IS DISCONNECTED
AND THE OVEN(S) IS COOL**

1. All repairs and maintenance of electrical units must be carried out by authorised electricians; even then, electrical access panels must not be opened unless the mains supply to the oven is isolated.
2. All connections to the oven must be made in accordance with the statutory requirements of the country of installation.
3. All versions should be part of a regular cleaning schedule.
Water should be drained and parts cleaned with an antibacterial wash.
4. While the oven is in operation (and for some time after use), **it is inadvisable to touch the condenser or the surrounds because of conducted heat.**
5. The condenser must be operated as described in this manual.
6. Only **MONO** spare parts should be used on this condenser.
7. The construction of the condenser must not be changed.

OPERATION

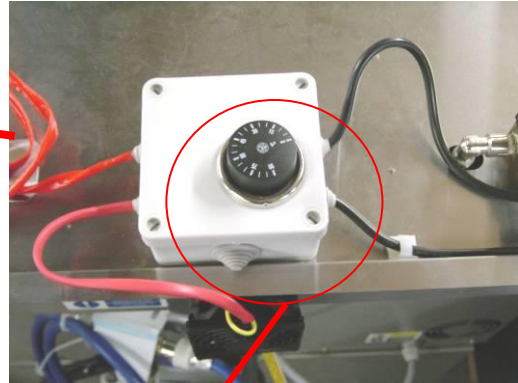
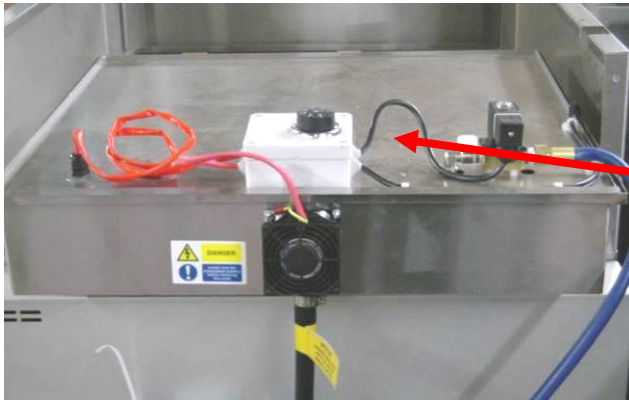

SETTING POSITION

1. Ensure that the water is connected correctly and the oven power is on.
2. The thermostat control should be adjusted to the required position.

*It is suggested that as a starting point the thermostat is set at 60.
It can then be adjusted down if the performance drops or adjusted up if it is found that the water is being replaced too often.*

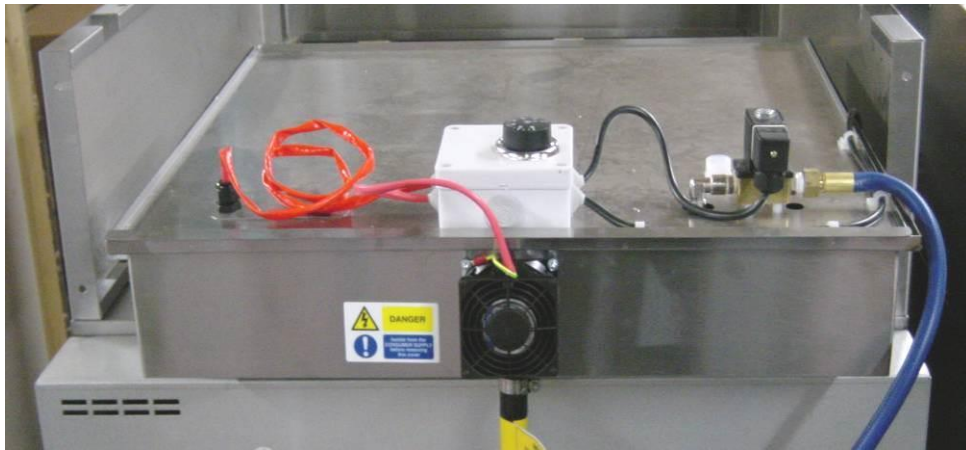

CONDENSER SPARES INFORMATION

FOR ENGINEERS USE ONLY.

**DO NOT ATTEMPT ANY ALTERATIONS.
IF IN DOUBT, CONTACT MONO EQUIPMENT FOR ADVICE**

CONDENSER UNIT MAIN PARTS

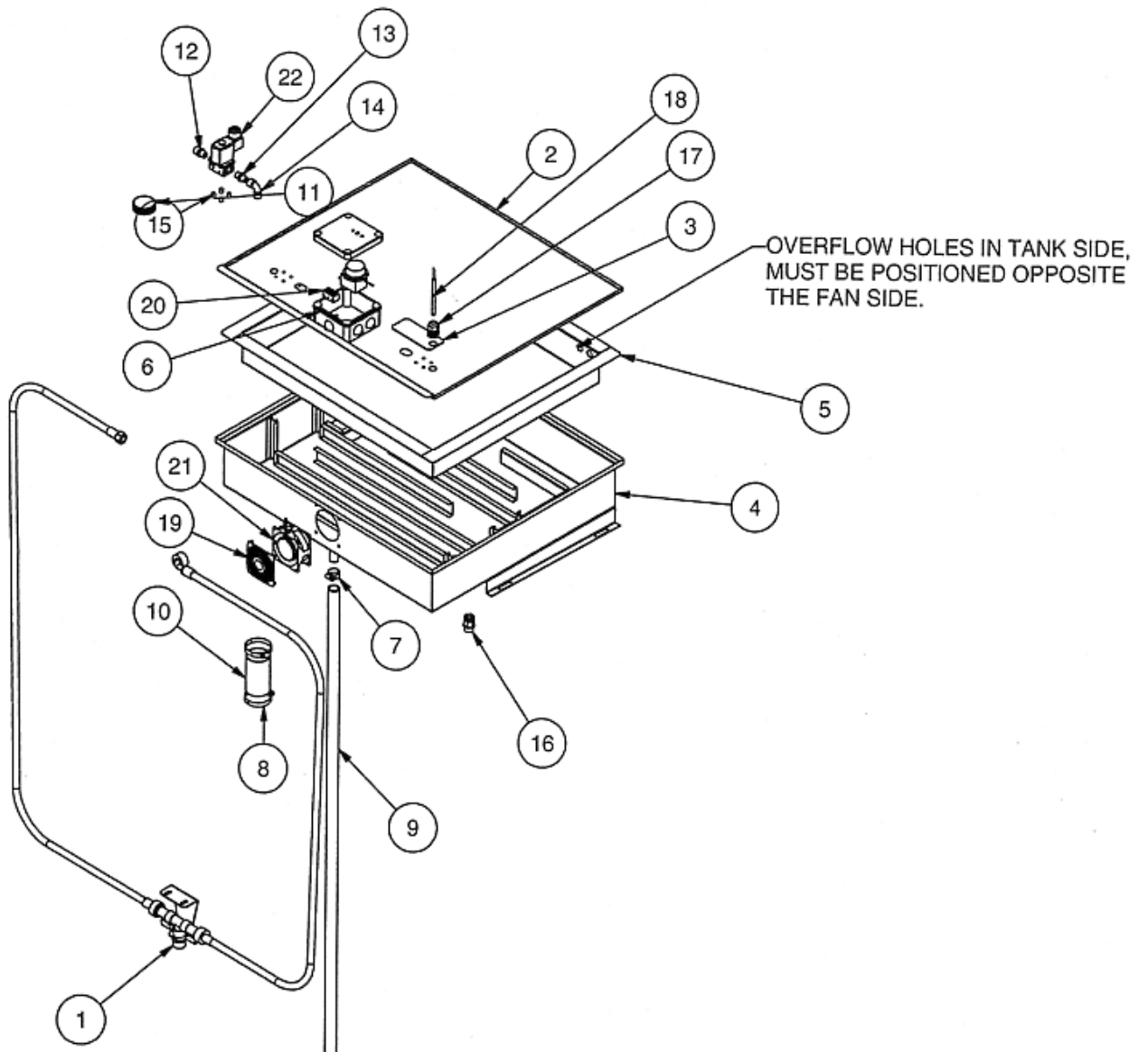

ITEM	PART No.	DESCRIPTION	QTY
①	150-07-01300	INLET WATER CONTROL UNIT	1
②	150-19-01700	TOP SHEET	1
③	150-19-02300	COVER PLATE	1
④	150-19-02600	BASE TRAY	1
⑤	150-19-02700	WATER TANK	1
⑥	150-25-07100	JUNCTION BOX	1
⑦	A900-01-196	WORM DRIVE CLIP	1
⑧	A900-01-271	WORM DRIVE CLIP	2
⑨	A900-23-004	DRAIN TUBE (2 METRES)	1
⑩	A900-23-027	FLEXIBLE TUBE	1
⑪	A900-27-187	PLUG INSERT	1
⑫	A900-34-191	REDUCER ¼" BSP MALE X 3/8" BSPT MALE	1
⑬	A900-34-244	REDUCER ¼" BSP MALE X ¼" BSPT MALE	1
⑭	A900-34-245	ELBOW	1
⑮	B811-33-001	SPACER	4
⑯	B839-17-003	CABLE GLAND TYPE 251	1
⑰	B842-17-005	CABLE GLAND TYPE 206-6096	1
⑱	B842-30-003	THERMOSTAT	1
⑲	B842-40-002	FAN GUARD	1
⑳	B842-50-005	PORCELAIN CONNECTING BLOCK	1
㉑	B869-75-003	FAN	1
㉒	B867-83-011	SOLENOID VALVE	1

OTHER VERSIONS THAT MAY BE FITTED

The following evaporation design versions could be fitted to your oven.

They only require to be plugged in to the socket found to the rear of the oven.



This powers the fan and evaporation pad.

No drain is required.

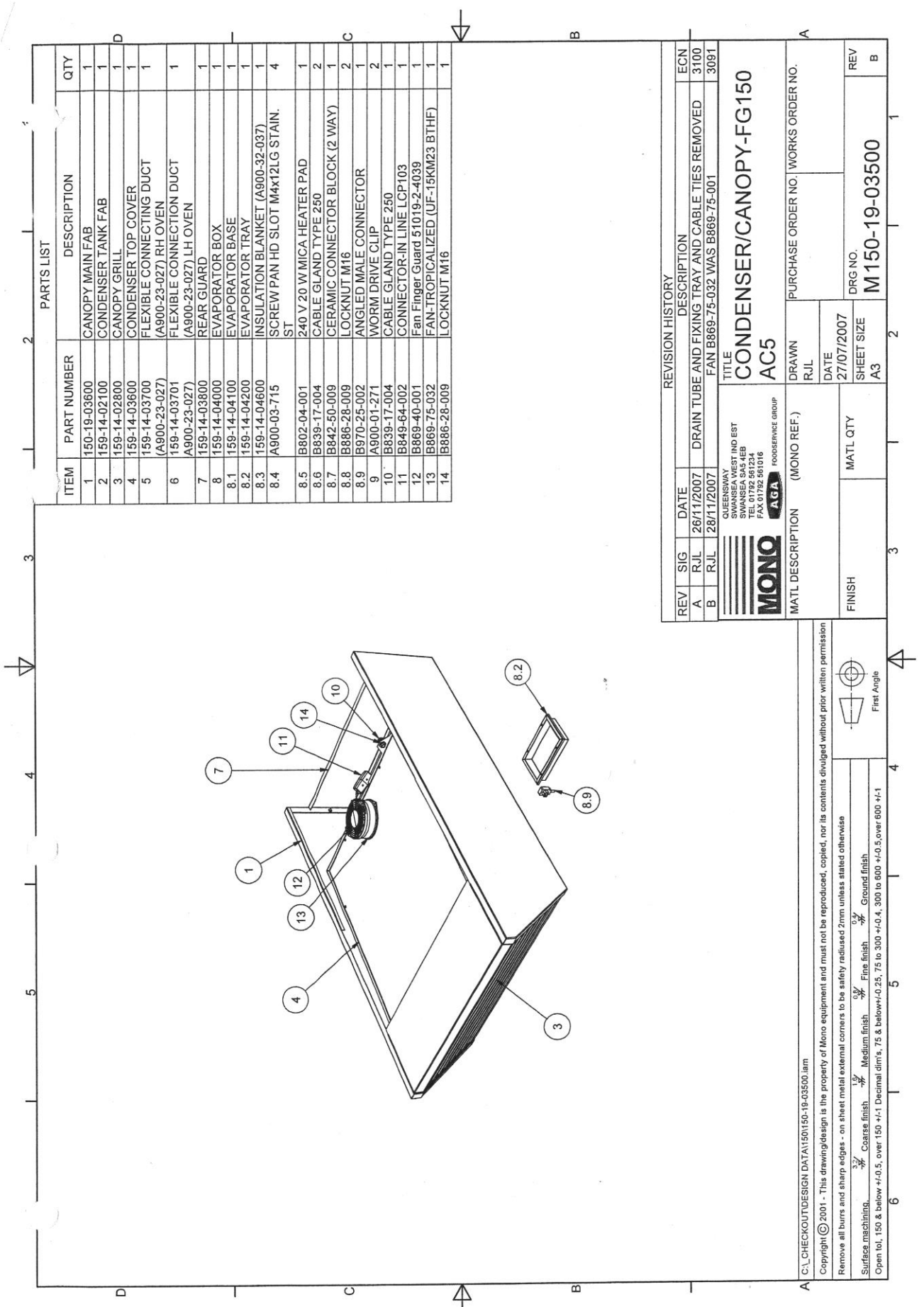

PARTS LIST

ITEM	PART NUMBER	DESCRIPTION	QTY
1	150-19-03600	CANOPY MAIN FAB	1
2	159-14-02100	CONDENSER TANK FAB	1
3	159-14-02800	CANOPY GRILL	1
4	159-14-03600	CONDENSER TOP COVER	1
5	159-14-03700 (A900-23-027)	FLEXIBLE CONNECTING DUCT (A900-23-027) RH OVEN	1
6	159-14-03701 (A900-23-027)	FLEXIBLE CONNECTION DUCT (A900-23-027) LH OVEN	1
7	159-14-03800	REAR GUARD	1
8	159-14-04000	EVAPORATOR BOX	1
8.1	159-14-04100	EVAPORATOR BASE	1
8.2	159-14-04200	EVAPORATOR TRAY	1
8.3	159-14-04600	INSULATION BLANKET (A900-32-037)	1
8.4	A900-03-715	SCREW PAN HD SLOT M4x12LG STAIN. ST	4
8.5	B802-04-001	240 V 20 W MICA HEATER PAD	1
8.6	B839-17-004	CABLE GLAND TYPE 250	2
8.7	B842-50-009	CERAMIC CONNECTOR BLOCK (2 WAY)	1
8.8	B886-28-009	LOCKNUT M16	2
8.9	B970-25-002	ANGLED MALE CONNECTOR	1
9	A900-01-271	WORM DRIVE CLIP	2
10	B839-17-004	CABLE GLAND TYPE 250	1
11	B849-04-002	CONNECTOR-IN LINE LCP103	1
12	B869-40-001	Fan Finger Guard 51019-2-4039	1
13	B869-75-032	FAN-TROPICALIZED (UF-15KM23 BTHF)	1
14	B886-28-009	LOCKNUT M16	1

REV	SIG	DATE	DESCRIPTION	ECN
A	RJL	26/11/2007	DRAIN TUBE AND FIXING TRAY AND CABLE TIES REMOVED	3100
B	RJL	28/11/2007	FAN B869-75-032 WAS B869-75-001	3091

MONO <small>QUEENSWAY SWANSEA WA5 4EB TEL 01792 861234 FAX 01792 861016</small>		AGA FOODSERVICE GROUP	
MATL DESCRIPTION (MONO REF.)		PURCHASE ORDER NO. WORKS ORDER NO.	
FINISH		DRAWN RJL	DATE 27/07/2007
MATL QTY		SHEET SIZE A3	DRG NO. M150-19-03500
REV		B	

C:\CHECKOUT\DESIGN DAT\150-19-03500.lim

Copyright © 2001 - This drawing/design is the property of Mono equipment and must not be reproduced, copied, nor its contents divulged without prior written permission

Remove all burrs and sharp edges - on sheet metal external corners to be safety radiused 2mm unless stated otherwise

Surface machining: $\frac{1}{16}$ Coarse finish $\frac{1}{32}$ Medium finish $\frac{1}{64}$ Fine finish $\frac{1}{128}$ Ground finish

Open tol, 150 & below ± 0.5 , over 150 ± 1 Decimal dim's, 75 & below ± 0.25 , 75 to 300 ± 0.4 , 300 to 600 ± 0.5 , over 600 ± 1

First Angle

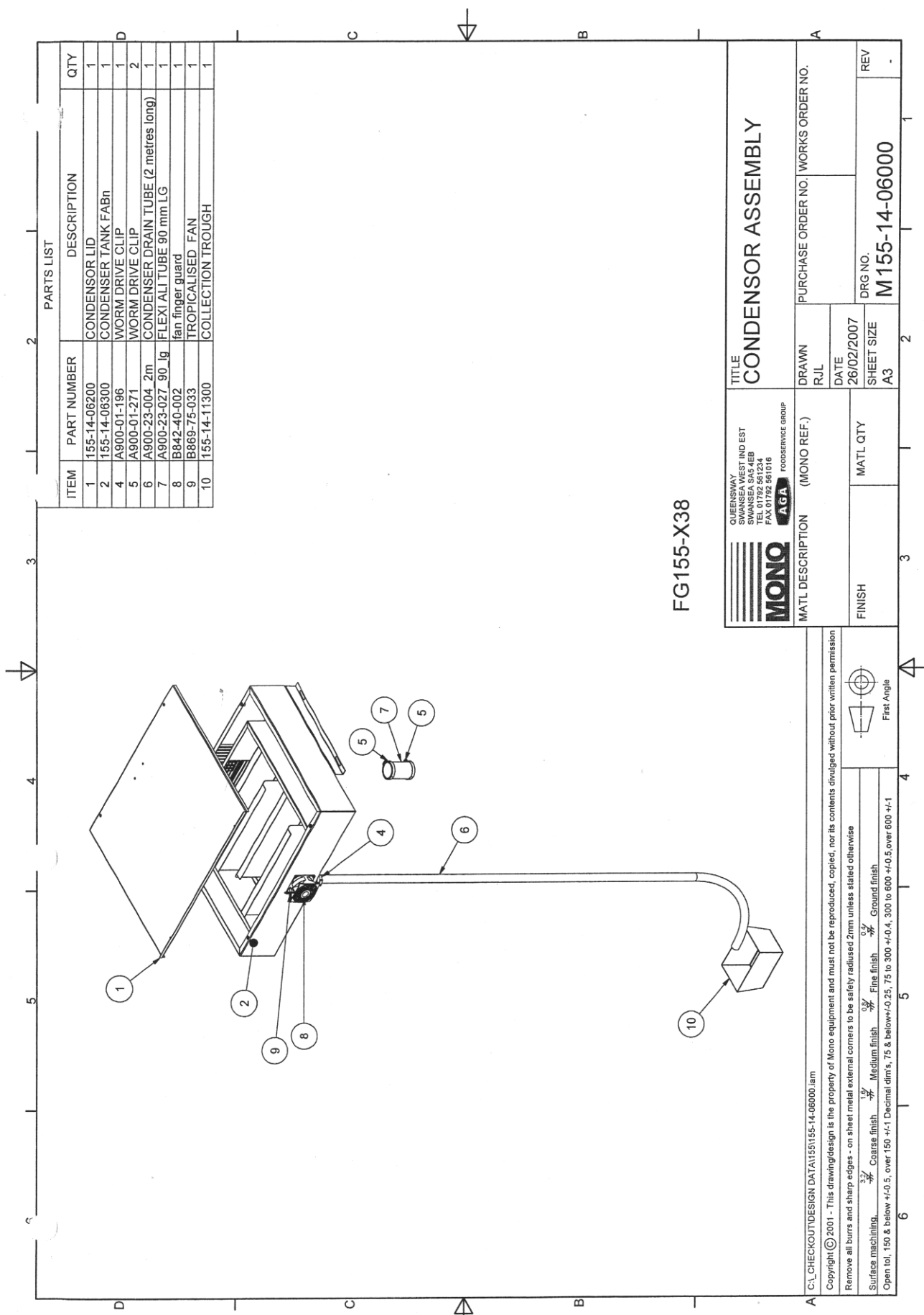

FG155-X38

ITEM	PART NUMBER	DESCRIPTION	QTY
1	155-14-06200	CONDENSOR LID	1
2	155-14-06300	CONDENSER TANK FABn	1
4	A900-01-196	WORM DRIVE CLIP	1
5	A900-01-271	WORM DRIVE CLIP	2
6	A900-23-004_2m	CONDENSER DRAIN TUBE (2 metres long)	1
7	A900-23-027_90_lg	FLEXI ALI TUBE 90 mm LG	1
8	B842-40-002	fan finger guard	1
9	B869-75-033	TROPICALISED FAN	1
10	155-14-11300	COLLECTION TROUGH	1

MONO QUEENSWAY INDUSTRIAL EST SWANSEA SA5 4EB TEL 01752 561234 FAX 01752 561016 AGA FOODSERVICE GROUP		TITLE CONDENSOR ASSEMBLY	
MATL DESCRIPTION (MONO REF.)		DRAWN R/JL	PURCHASE ORDER NO. WORKS ORDER NO.
FINISH		DATE 26/02/2007	SHEET SIZE A3
MATL QTY		DRG NO. M155-14-06000	

C:\CHECKOUT\DESIGN DATA\15514-06000.iam
 Copyright © 2001 - This drawing/design is the property of Mono equipment and must not be reproduced, copied, nor its contents divulged without prior written permission.
 Remove all burrs and sharp edges - on sheet metal external corners to be safely radiused 2mm unless stated otherwise
 Surface machining: $\frac{3}{4}$ Coarse finish $\frac{1.5}{4}$ Medium finish $\frac{0.5}{4}$ Fine finish $\frac{0.25}{4}$ Ground finish
 Open tol, 150 & below ± 0.5 , over 150 ± 1 Decimal dims, 75 & below ± 0.25 , 75 to 300 ± 0.4 , 300 to 600 ± 0.5 , over 600 ± 1

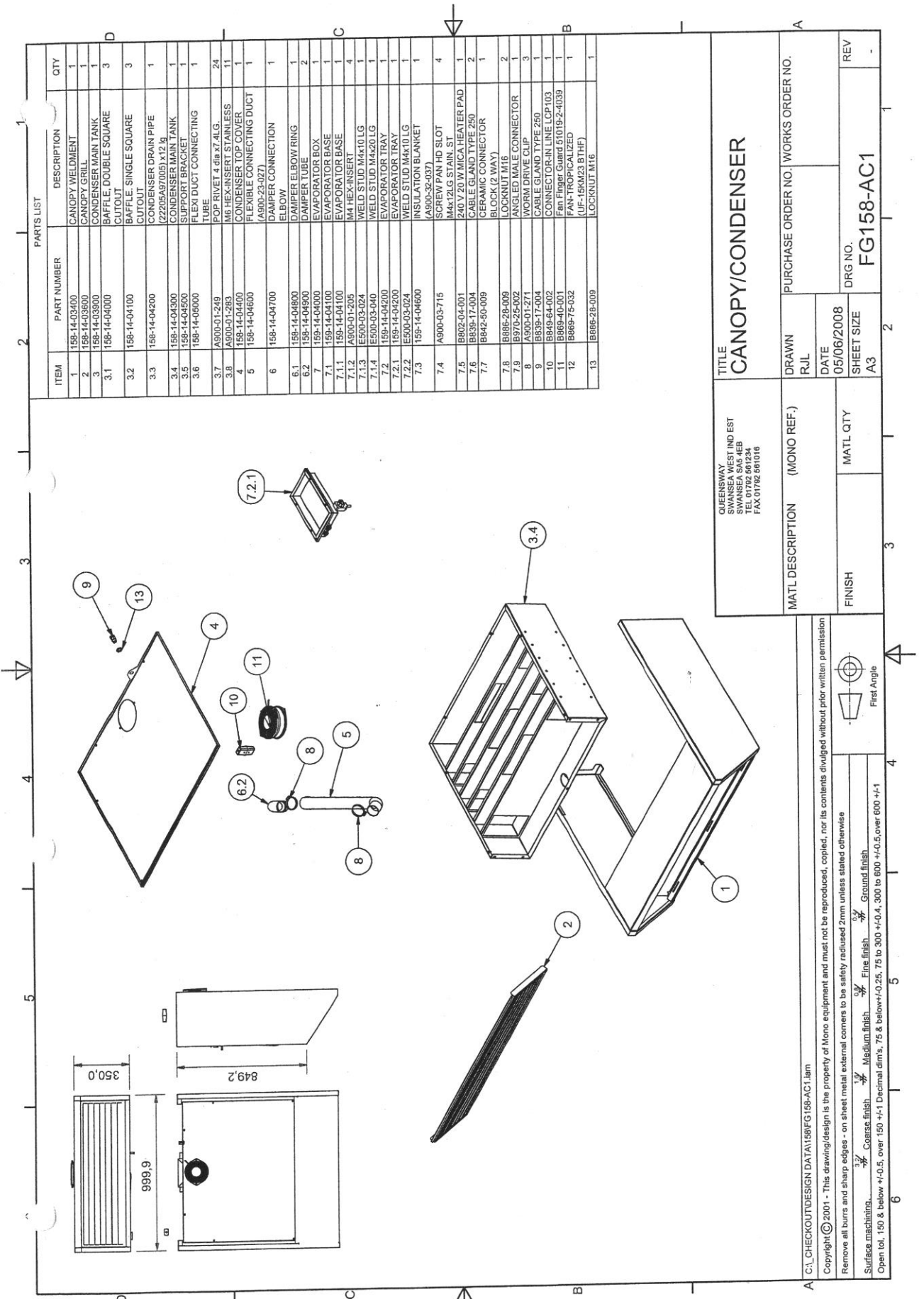

ITEM	PART NUMBER	DESCRIPTION	QTY
1	158-14-02400	CANOPY WELDMENT	1
2	158-14-03600	CANOPY GRILL	1
3	158-14-03800	CONDENSER MAIN TANK	1
3.1	158-14-04000	BAFFLE DOUBLE SQUARE CUTOUT	3
3.2	158-14-04100	BAFFLE SINGLE SQUARE CUTOUT	3
3.3	158-14-04200	CONDENSER DRAIN PIPE (22205A97005) X12 IN.	1
3.4	158-14-04300	CONDENSER MAIN TANK SUPPORT BRACKET	1
3.5	158-14-04500	FLEXI DUCT CONNECTING TUBE	1
3.6	158-14-05600	POP RIVET 4 dia x7 ALG.	24
3.7	A900-01-249	M6 HEX-INSERT STAINLESS	11
3.8	A900-01-283	CONDENSER TOP COVER	1
4	158-14-04400	FLEXIBLE CONNECTING DUCT (A900-23-027)	1
5	158-14-04600	DAMPER CONNECTION ELBOW	1
6	158-14-04700	DAMPER ELBOW RING	1
6.1	158-14-04800	DAMPER LUBE	2
6.2	158-14-04900	EVAPORATOR BOX	1
7	159-14-04000	EVAPORATOR BASE	1
7.1	159-14-04100	M4 HEX-INSERT	4
7.1.1	A900-01-205	WELD STUD M4x10 LG	1
7.1.2	E500-03-024	WELD STUD M4x20 LG	1
7.1.3	E500-03-040	EVAPORATOR TRAY	1
7.1.4	E500-03-040	EVAPORATOR TRAY	1
7.2	159-14-04200	WELD STUD M4x10 LG	1
7.2.1	159-14-04200	WELD STUD M4x10 LG	1
7.2.2	E500-03-024	INSULATION BLANKET (A900-32-037)	1
7.3	159-14-04600	SCREW PAN HD SLOT M4x12LG STAIN. ST	4
7.4	A900-03-715	240 V 20 W MICA HEATER PAD	1
7.5	B602-04-001	CABLE GLAND TYPE 250	2
7.6	B838-17-004	CERAMIC CONNECTOR	1
7.7	B842-50-009	LOCKNUT (2 WAY)	2
7.8	B886-28-009	ANGLED MALE CONNECTOR	1
7.9	B976-25-002	WORM DRIVE CLIP	3
8	A900-01-271	CABLE GLAND TYPE 250	1
9	B838-17-004	CONNECTOR-IN LINE LCP103	1
10	B849-64-002	Fan Finger Guard 510192-4039	1
11	B869-40-001	FAN-TROPICALIZED (UF-15RM23 B1HF)	1
12	B869-75-032	LOCKNUT M16	1
13	B886-28-009	LOCKNUT M16	1

TITLE CANOPY/CONDENSER		PURCHASE ORDER NO. WORKS ORDER NO.	
QUEENSWAY SWANSEA WEST IND EST SWANSEA ROAD SWANSEA SA6 6PP FAX 01782 851016	DRAWN	DATE	
MATL DESCRIPTION (MONO REF.)	R/JL	05/06/2008	
FINISH	MATL QTY	SHEET SIZE	
		A3	
		DRG NO.	
		FG158-AC1	
		REV	
		-	

C:\CHECKOUT\DESIGN DATA\158\FG158-AC1.lam
 Copyright © 2001 - This drawing/design is the property of Mono equipment and must not be reproduced, copied, nor its contents divulged without prior written permission
 Remove all burrs and sharp edges - on sheet metal external corners to be safely radiused 2mm unless stated otherwise
 Surface machining: $\frac{1}{2}$ Coarse finish $\frac{1}{4}$ Medium finish $\frac{1}{8}$ Fine finish $\frac{1}{16}$ Ground finish
 Open tol, 150 & below ± 0.5 , over 150 ± 1 Decimal dim's, 75 & below ± 0.25 ; 75 to 300 ± 0.4 , 300 to 600 ± 0.5 , over 600 ± 1
 First Angle

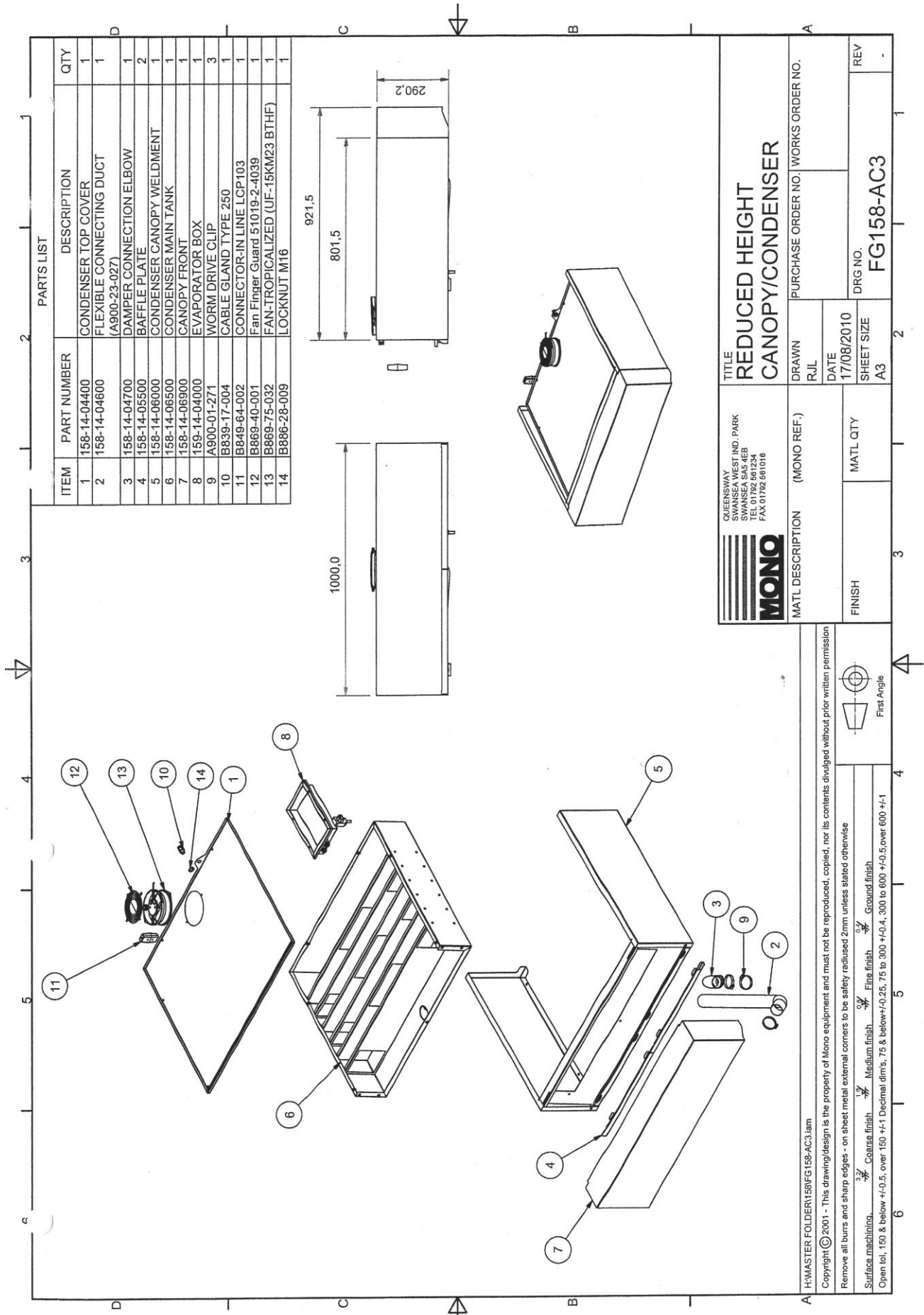

PARTS LIST

ITEM	PART NUMBER	DESCRIPTION	QTY
1	158-14-04400	CONDENSER TOP COVER	1
2	158-14-04600	FLEXIBLE CONNECTING DUCT (A900-23-027)	1
3	158-14-04700	DAMPER CONNECTION ELBOW	1
4	158-14-05500	BAFFLE PLATE	2
5	158-14-06000	CONDENSER CANOPY WELDMENT	1
6	158-14-06500	CONDENSER MAIN TANK	1
7	158-14-06900	CANOPY FRONT	1
8	158-14-04000	EVAPORATOR BOX	1
9	A900-01-271	WORM DRIVE CLIP	3
10	B839-17-004	CABLE GLAND TYPE 250	1
11	B849-64-002	CONNECTOR-IN LINE LCP103	1
12	B869-40-001	Fan Finger Guard 51019-2-4039	1
13	B869-75-032	FAN-TROPICALIZED (UF-15KM23 BTHF)	1
14	B886-28-009	LOCKNUT M16	1

		QUEENSWAY SWANSEA WEST IND. PARK SWANSEA SA5 4EB TEL 01782 561234 FAX 01782 561016	
TITLE REDUCED HEIGHT CANOPY/CONDENSER		PURCHASE ORDER NO. WORKS ORDER NO.	
MATL DESCRIPTION (MONO REF.)		DRAWN R.J.L.	DATE 17/08/2010
FINISH	MATL QTY	SHEET SIZE A3	DRG NO. FG158-AC3
Remove all burrs and sharp edges - on sheet metal external corners to be safely radiused 2mm unless stated otherwise		REV -	

H-MASTER FOLDER158FG 158-AC3.lam
 Copyright © 2001. This drawing/design is the property of Mono equipment and must not be reproduced, copied, nor its contents divulged without prior written permission
 Surface machining: $\frac{3}{2}$ Coarse finish, $\frac{1}{2}$ Medium finish, $\frac{0}{2}$ Fine finish, $\frac{0}{2}$ Ground finish
 Open tol, 150 & below ± 0.5 , over 150 ± 1 Decimal dim's, 75 & below ± 0.25 , 75 to 300 ± 0.4 , 300 to 600 ± 0.5 , over 600 ± 1
 First Angle

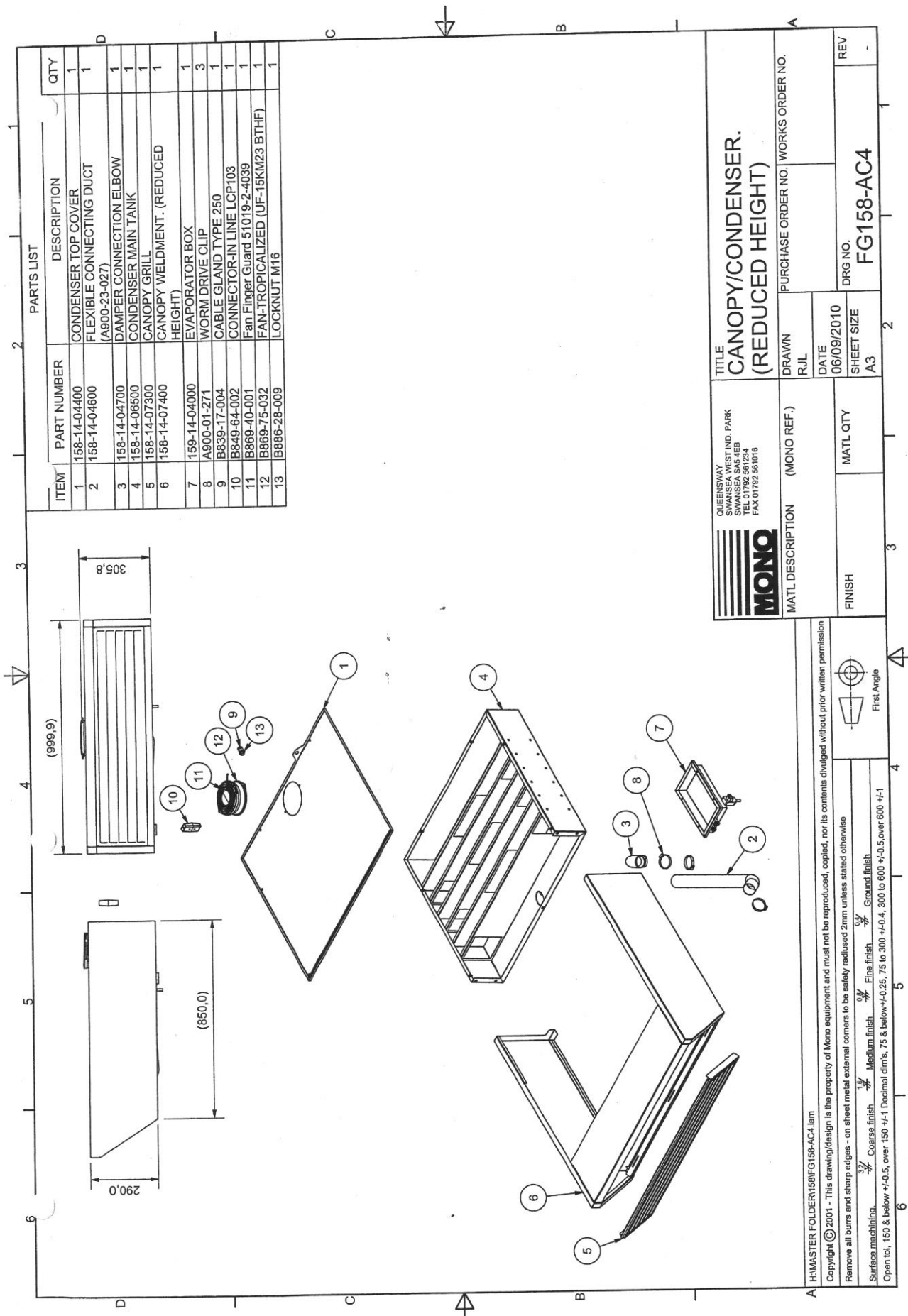

ITEM	PART NUMBER	DESCRIPTION	QTY
1	158-14-04400	CONDENSER TOP COVER	1
2	158-14-04600	FLEXIBLE CONNECTING DUCT (A900-23-027)	1
3	158-14-04700	DAMPER CONNECTION ELBOW	1
4	158-14-06500	CONDENSER MAIN TANK	1
5	158-14-07300	CANOPY GRILL	1
6	158-14-07400	CANOPY WELDMNT. (REDUCED HEIGHT)	1
7	159-14-04000	EVAPORATOR BOX	1
8	A900-01-271	WORM DRIVE CLIP	3
9	B839-17-004	CABLE GLAND TYPE 250	1
10	B849-64-002	CONNECTOR-IN LINE LCP103	1
11	B869-40-001	Fan Finger Guard 51019-2-4039	1
12	B869-75-032	FAN-TROPICALIZED (UF-15KM23 BTHF)	1
13	B866-28-009	LOCKNUT M16	1

MONO QUEENSWAY INDUSTRIAL PARK SWANSEA SA5 4EB TEL 01792 861234 FAX 01792 861016		TITLE CANOPY/CONDENSER. (REDUCED HEIGHT)	
MATL DESCRIPTION (MONO REF.)		DRAWN R./J.L	PURCHASE ORDER NO. WORKS ORDER NO.
FINISH		DATE 06/09/2010	DRG NO. FG158-AC4
MATL QTY		SHEET SIZE A3	REV -

H/MASTER FOLDER\FG158-AC4.lam
 Copyright © 2001 - This drawing/design is the property of Mono equipment and must not be reproduced, copied, nor its contents divulged without prior written permission
 Remove all burrs and sharp edges - on sheet metal external corners to be safety radiused 2mm unless stated otherwise
 Surface machining:
 3/3 Coarse finish 1/3 Medium finish 0/3 Fine finish 0/3 Ground finish
 Open tol. 150 & below +/0.5, over 150 +/1 Decimal dim's, 75 & below +/0.25, 75 to 300 +/0.4, 300 to 600 +/0.5, over 600 +/1

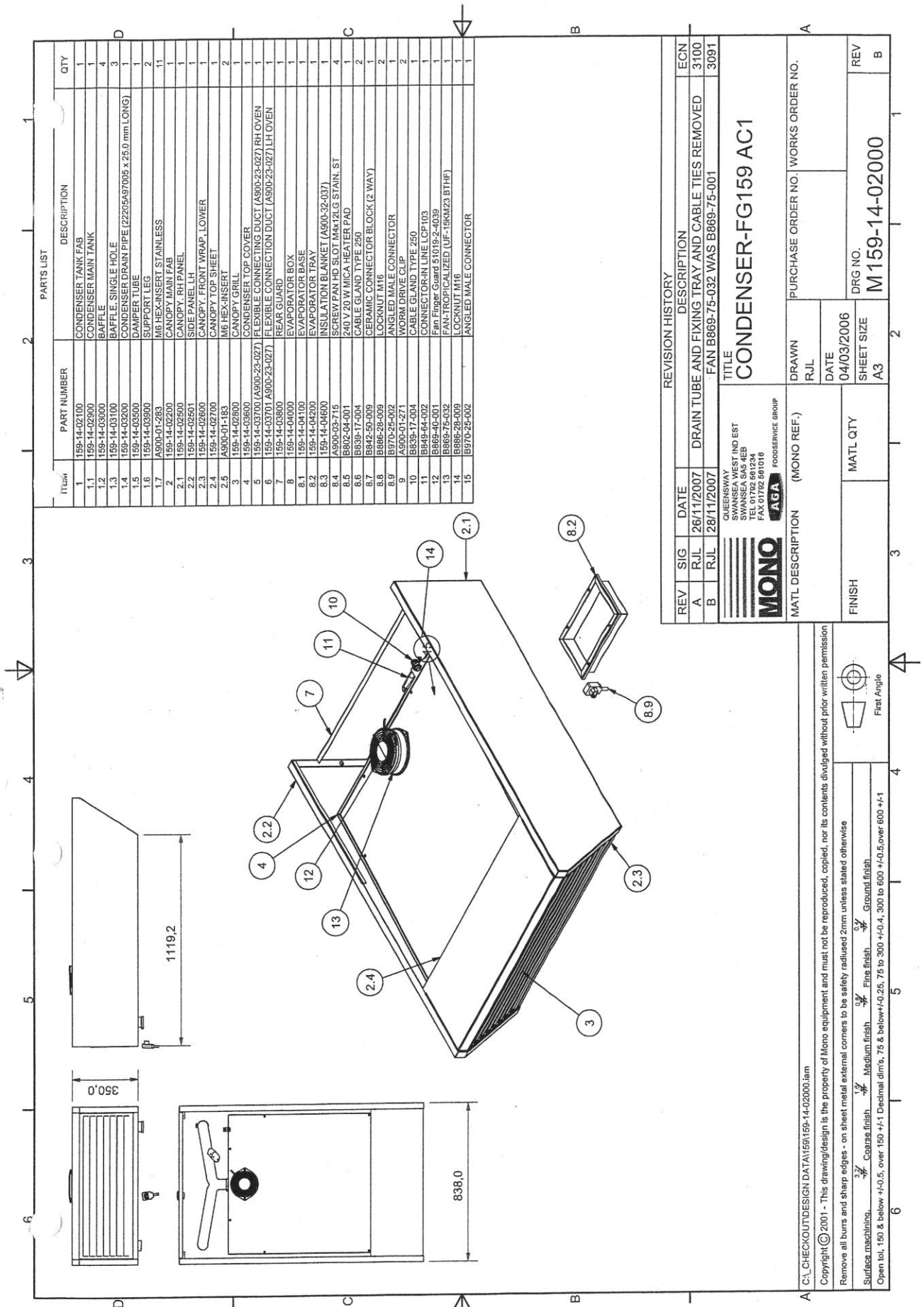

ITLW	PART NUMBER	DESCRIPTION	QTY
1	159-14-02100	CONDENSER TANK FAR	1
1.1	159-14-02600	CONDENSER MAIN TANK	1
1.2	159-14-03000	BAFFLE	4
1.3	159-14-03100	BAFFLE SINGLE HOLE	3
1.4	159-14-03200	CONDENSER DRAIN PIPE (22205A97005 x 25.0 mm LONG)	1
1.5	159-14-03300	WASHER TIE	1
1.6	159-14-03400	SUPPORT LEG	2
1.7	159-14-03500	WASHER TIE STAINLESS	11
1.8	159-14-03600	WASHER TIE	1
2.1	159-14-02601	CANOPY RH PANEL	1
2.2	159-14-02601	CANOPY LH	1
2.3	159-14-02600	CANOPY FRONT WRAP 1 LOWER	1
2.4	159-14-02700	CANOPY TOP SHEET	1
2.5	A900-01-183	M6 HEX INSERT	2
3	159-14-02600	CANOPY GRILL	1
4	159-14-03600	CONDENSER TOP COVER	1
5	159-14-03700 (A900-23-027)	FLEXIBLE CONNECTING DUCT (A900-23-027) RH OVEN	1
6	159-14-03701 (A900-23-027)	FLEXIBLE CONNECTING DUCT (A900-23-027) LH OVEN	1
7	159-14-03800	REAR GUARD	1
8	159-14-04000	EVAPORATOR BOX	1
8.1	159-14-04100	EVAPORATOR BASE	1
8.2	159-14-04200	EVAPORATOR TRAY	1
8.3	159-14-04600	INSULATION BLANKET (A900-32-037)	1
8.4	A900-03-715	SCREW PAN HD SLOT M4x12LG STAIN. ST	4
8.5	B802-04-001	240 V 20 W MICA HEATER PAD	1
8.6	B839-17-004	CABLE GLAND TYPE 250	2
8.7	B842-50-009	CERAMIC CONNECTOR BLOCK (2 WAY)	1
8.8	B886-28-009	LOCKNUT M16	2
8.9	B970-25-002	ANGLED MALE CONNECTOR	1
9	A900-01-271	WORM DRIVE CLIP	2
10	B839-17-004	CABLE GLAND TYPE 250	1
11	B849-64-002	CONNECTOR-IN LINE LCP 103	1
12	B869-40-001	Fan Flange Guard 51019-2-039	1
13	B869-75-032	FAN-TROPICALIZED (UF-18KM23 BTHF)	1
14	B886-28-009	LOCKNUT M16	1
15	B970-25-002	ANGLED MALE CONNECTOR	1

REV	SIG	DATE	DESCRIPTION	ECN
A	RJL	26/11/2007	DRAIN TUBE AND FIXING TRAY AND CABLE TIES REMOVED	3100
B	RJL	28/11/2007	FAN B869-75-032 WAS B869-75-001	3091

QUEENSWAY SWANSEA WEST IND EST 159-14-03600 TEL 01792 881234 TEL 01792 881018 FAX 01792 881018 MONO AGA FOODSERVICE GROUP		TITLE CONDENSER-FG159 AC1
MATL DESCRIPTION (MONO REF.) DRAWN RULL		PURCHASE ORDER NO. WORKS ORDER NO.
FINISH MATL QTY		DATE 04/03/2006
SHEET SIZE A3		DRG NO. M159-14-02000
REV B		REV B

C:\CHECKOUT\DESIGN DATA\159\159-14-02000.lam

Copyright © 2001 - This drawing/design is the property of Mono equipment and must not be reproduced, copied, nor its contents divulged without prior written permission

Remove all burrs and sharp edges - on sheet metal external corners to be safely radiused 2mm unless stated otherwise

Surface machining:
 Coarse finish
 Medium finish
 Fine finish
 Ground finish

Open tol. 150 & below +/-0.5, over 150 +/-1
 Decimal dims, 75 & below +/-0.25, 75 to 300 +/-0.4, 300 to 600 +/-0.5, over 600 +/-1

Fit. Angle

If a fault arises, please do not hesitate to contact the
Customer Service Department, quoting the **machine serial number**
on the silver information plate of the machine and on the front cover of this manual

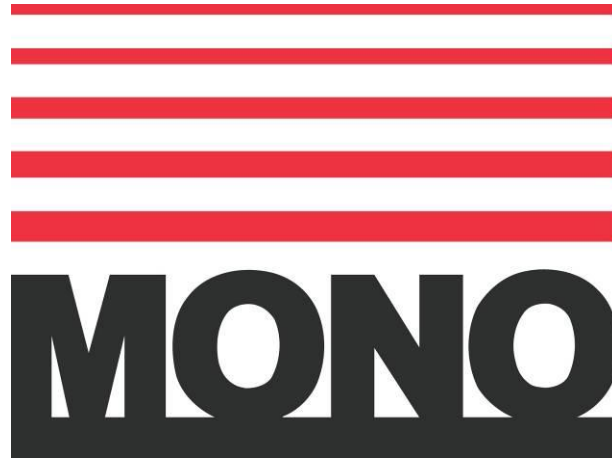

MONO

Queensway
Swansea West Industrial Estate
Swansea. SA5 4EB UK

email: spares@monoequip.com
Web site: www.monoequip.com

Tel. 01792 561234
Spares 44+(0)1792 564039
Fax. 01792 561016

□ **OVEN DISPOSAL**

CARE SHOULD BE TAKEN WHEN THE MACHINE COMES TO THE END OF ITS WORKING LIFE. ALL PARTS SHOULD BE DISPOSED OF IN THE APPROPRIATE PLACE, EITHER BY RECYCLING OR OTHER MEANS OF DISPOSAL THAT COMPLIES WITH LOCAL REGULATIONS.

(IN UK, ENVIRONMENTAL PROTECTION ACT 1990 APPLIES)