

MonoEquip.com

Enter **Serial No.** here \_\_\_\_\_

In the event of an enquiry please quote this serial number.



**AZTEC**

**DOUGHNUT FRYER  
(PLC / MK3)**

## **OPERATING AND MAINTENANCE MANUAL**



## DECLARATION OF CONFORMITY

We hereby declare that this machine complies with the essential health and safety requirements of :-

- The Machinery Directive 2006 / 42 / EC
- The Low voltage Directive 2006 / 95 / EC
- The requirements of the Electromagnetic Compatibility Directive 2004 / 108EC, 91 / 263 / EEC, 92 / 31 / EEC
- The General Safety of Machinery and food processing Standards applicable
- Materials and Articles intended to come into contact with food - Regulation (EC) No. 1935 / 2004
- Good manufacturing practice for Materials intended to come into contact with food - Regulation (EC) No. 2023 / 2006

<b>Signed</b>	
<b>D. Osmundsen – Quality and Conformance Manager</b>	

<b>Date</b>	
-------------	--

<b>Machine FG Code.</b>		<b>Machine Serial No.</b>	
-------------------------	--	---------------------------	--

A technical construction file for this machine is retained at the following address:

**MONO EQUIPMENT**  
 Queensway,  
 Swansea West Industrial Park,  
 Swansea  
 SA5 4EB  
 UK

**MONO EQUIPMENT** is a business name of **AFE GROUP Ltd**  
 Registered in England No.3872673    VAT registration No.923428136

Registered office: Unit 35,  
 Bryggen Road,  
 North Lynn Industrial Estate,  
 Kings Lynn Norfolk,  
 PE30 2HZ

## SAFETY SYMBOLS

The following safety symbols are used throughout this document (available at [www.monoequip.com](http://www.monoequip.com)). Before using your new equipment, read the instruction manual carefully and pay special attention to information marked with the following symbols:

**WARNING**

Indicates a hazardous situation which, if not avoided, could result in death or severe injury.

**WARNING**

Indicates a hazardous situation which, if not avoided, could result in death or severe injury.

**CAUTION**

Indicates a hazardous situation which, if not avoided, could result in minor or moderate injury.



## ELECTRICAL SAFETY AND ADVICE REGARDING SUPPLEMENTARY ELECTRICAL PROTECTION

Commercial kitchens and food service areas are environments where electrical appliances may be located close to liquids or operate in and around damp conditions or where the restricted movement for installation and service is evident.

The installation and periodic inspection of the appliance should only be undertaken by a qualified, skilled and competent electrician, and connected to the correct power supply suitable for the load as stipulated by the appliance data label.

The electrical installation and connections should meet the necessary requirements of the local electrical wiring regulations and any safety guidelines.

### We recommend:-

- Supplementary electrical protection with the use of a Residual Current Device (RCD)
- Fixed wiring appliances should also incorporate a locally situated switch disconnector to connect to, which is easily accessible for switching off and safe isolation purposes. The switch disconnector must meet the specification requirements of IEC 60947.

### Your attention is drawn to:-

#### **BS 7671:2018 – Guidance Note 8 – 8.13: Other locations of increased safety risk**

It is recognised that there may be locations of increased risk of electrical shock other than those specifically addressed in Part 7 of BS 7671. Examples of such locations could include laundries where there are washing and drying machines in close proximity and water is present, and commercial kitchens with stainless steel units, where once again, water is present. Where, because of the perception of additional risks being likely, the installation designer decides that an installation or location warrants further protective measures, the options available includes:

- Automatic Disconnection of Supply (ADS) by means of a residual current device having a residual operating current not exceeding 30 mA;
- Supplementary protective equipotential bonding; and
- Reduction of maximum fault clearance time.

The provision of RCDs and supplementary bonding must be specified by the host organisation's appointed installation designer or electrical contractor and installed by a suitably qualified and competent electrician so as to comply with Regulations 419.2 and 544.2.



The supply to this machine must be protected by a **30mA RCD**



## CATERING INFORMATION SHEET No. 17

### Safety during emptying and cleaning of fryers

#### HSE information sheet

##### Introduction

This information sheet was produced by the Hospitality and Catering Industry Liaison Forum, which has members from trade and professional associations, unions and enforcement authorities. Members' associations are free to reproduce and distribute this guidance to catering establishments. The guidance is issued by the Health and Safety Executive.

This sheet provides advice to employers in the catering industry on safe emptying and cleaning of fryers. It gives guidance on manual emptying and cleaning and guidance on fryers with automated or semi-automated filtering (using enclosed portable filtering units).

Automated and semi-automated filtering processes avoid operators coming into contact with hot oil, significantly reducing the risks. This enables filtering to take place safely even while the oil is at normal cooking temperature. Most automated or semiautomated systems require an oil temperature of at least 100 °C for the filtering process to work effectively.

**You should only carry out manual emptying and filtering of fryers when the oil has been cooled to 40 °C or below.**

##### Key messages

- Burns from hot oil can be very serious.
- Oil takes only 6–7 minutes to heat up but can take 6–7 hours to cool down again.

##### What the law says

The Health and Safety at Work etc Act 1974 (the HSW Act) places a duty on employers to ensure, so far as reasonably practicable, the health, safety and welfare of their employees. This duty extends, amongst other things, to providing and maintaining systems of work which are, so far as reasonably practicable, safe and without risks to health. The HSW Act also places a duty on employees to take reasonable care of their own and others' health and safety.

Whichever type of fryer is used, you must:

- ensure the fryer is well maintained and any attachments used are suitable for their purposes, as recommended by the manufacturer – a procedure for reporting faults will help you comply with this duty;
- train staff in a safe system of work for emptying and cleaning;
- provide staff with suitable protective equipment where required by the risk assessment, eg eye protection, heat-resistant gloves, aprons.

### When to empty and clean

■ Many catering establishments are closed overnight. For fire safety and economy switch off fat fryers when unattended. Carry out oil filtering and cleaning as a **first task of the day rather than as part of the closing-down procedure.**

#### Hazards

The hazards in emptying and cleaning fryers include:

- fire.
- burns from hot oil.
- contact with hot surfaces.
- fumes from boiling cleaning chemicals.
- boiling chemicals overflowing.
- eye injuries from splashes.
- slips from oil spillage.
- strains and sprains from lifting and moving containers of oil. If the catering service runs for 24 hours and

the appliance is required continuously, there are two safe options:

### Health and Safety Executive

Page 2 of 4

- Use more than one fryer and clean them in rotation.
- Use an automated filtering system or a semiautomated portable filtering unit that removes the hot oil directly from the fryer, filters the oil and holds it safely.

### Automated and semi-automated filtering

#### Automated filtering systems

An automated system consists of an inbuilt oil filtration system. The oil is drained into an enclosed reservoir and an electric pump circulates it through a filter system and internal pipework back into the fryer.

Since this process is enclosed within the equipment, the operator does not come into contact with hot oil, greatly reducing any risk.

#### Portable oil filtering units (semi-automated)

These units are not part of the fryer, but sit alongside it. The operator attaches an extension pipe to the fryer and the hot oil is drained into an **enclosed** container within the portable unit. The oil is then filtered and returned to the fryer.

If you have a fryer with automated oil draining system or a portable oil filtering unit, refer to the manufacturer's guidelines for draining/filtering temperatures and safe operational requirements.

These, together with your own risk assessment, will determine the need for suitable protective equipment.

If there is still a risk from contact with hot surfaces or oil splashing, you may need to provide staff with eye protection, a protective apron and/or heat-resistant gloves/gauntlets.

### Manual oil filtering

This involves the operator draining the oil from the fryer through a filter into a suitable metal-holding or heat-resistant hard, plastic container and manually lifting it back into the fryer (fryer oil is often supplied in hard, plastic, rigid containers). Serious accidents have occurred where oil that has not sufficiently cooled has been drained back into an empty plastic container and the base of the container has given way.

To drain oil safely and in the correct sequence, follow these guidelines:

- Turn off the appliance and the power supply at the wall socket for electric appliances, and the on/off control for gas appliances.
- Allow the oil to cool, ideally for at least six hours, and check the temperature using a suitable probe thermometer before draining. Do not drain if the temperature is above 40 °C.
- Follow the manufacturer's instructions and use the correct equipment (eg a detachable spout for the type of fryer you are emptying), making sure to bring any equipment you need to the fryer before you start.
- Depending on the type of fryer, drain the oil by drain valve, removable spout, lifting container or by tilting.
- If the oil is too cold to drain easily, reheat it briefly and agitate with the fryer basket for no more than one minute. Switch the appliance off and check the temperature again before emptying.
- Using a filter, run the oil into a suitable metal holding or heat-resistant hard, plastic container. These containers will generally need carrying handles and a cover or lid. Before moving, make sure that the lid or cover is secure.
- Make sure the container is empty and big enough to take the volume of oil being drained at any time.
- When you are draining large volumes of oil it is safer to drain off in smaller amounts. This avoids overfilling the container and will reduce the chance of spillages when you move it. Smaller amounts will also be easier to carry.
- Place the container in a safe place where it cannot be contaminated with chemicals, water or foreign bodies. Place the container on top of a drip tray to avoid any floor contamination.
- Do not dispose of waste oil down the drain – disposal must comply with environmental legislation.
- Clean up any spillages **immediately**.
- Make sure floor areas around equipment are completely clean and dry to avoid slip risks (see also *Preventing slips and trips in kitchens and food service*).

Other precautions

Make sure the design of the drain-off tap prevents it being turned on accidentally:

## Health and Safety

### Executive

Page 3 of 4

- Mark clearly on it that the tap should not be touched.
- Place warning signs near the tap.
- If possible, remove the tap handle when the fryer is switched on.

### Cleaning procedure

This section applies to all types of fryers.

- Turn off the appliance, and the power supply at the wall socket for electric appliances and the on/off control for gas appliances.
- Wear suitable protective equipment, including eye protection (if appropriate).
- Check that other activities will not be put at risk by the cleaning activity.
- Check that the oil has been thoroughly drained and that there are no spillages that may cause slipping.
- Remove loose debris from the internal surfaces.
- Thoroughly wash all internal and external surfaces with suitable cleaning chemicals and check for any leaks.
- For stubborn residues, fill the fryer with your recommended cleaning agents and leave or simmer according to instructions.
- Do not leave the fryer unattended or allow it to boil as this may cause it to cascade liquid onto the floor, causing additional scalding and slipping hazards.
- Drain the appliance and rinse thoroughly with plenty of water.
- Dry all internal surfaces and make sure there is no water left in the fryer.

- Check the drain valve is closed and working properly, then refill and switch on as required.
- When refilling the fryer with oil, the oil container may be too large or heavy for one member of staff. Where possible, use smaller containers.
- Do not overfill the fryer. Follow the manufacturer's guidelines.
- Clean up any spillages **immediately**.
- Make sure floor areas around the equipment are completely clean and dry to avoid slip risks.

### Training

This section applies to all types of fryers.

- Make sure only staff trained in the safe use of the cleaning chemicals and cleaning procedures for the fryer do this task.
- Train staff in reporting procedures if they find the equipment is faulty or if they have experienced any practical difficulties with cleaning the fryer in their specific work environment.
- Make staff aware of the reason for using suitable protective equipment, ie gloves, eye protection.
- Complete risk assessments for hazardous chemicals and make staff aware of the correct procedures for using cleaning chemicals.
- Make safety data sheets available to staff.
- A short, written procedure can act as a reminder to staff for both draining and cleaning operations.

### Further reading

*Preventing slips and trips in kitchens and food service*

Catering Information Sheet CASI6(rev2) HSE 2012

[www.hse.gov.uk/pubns/cais6.htm](http://www.hse.gov.uk/pubns/cais6.htm)

*Safe use of cleaning substances in the hospitality industry* Catering Information Sheet CAIS22(rev2)

[www.hse.gov.uk/pubns/cais22.htm](http://www.hse.gov.uk/pubns/cais22.htm)

HSE has produced a suite of Catering Information Sheets and other guidance for the catering and hospitality industry. These are available on the HSE website at [www.hse.gov.uk/catering/index.htm](http://www.hse.gov.uk/catering/index.htm)

There is also helpful advice in Health and safety made simple: The basics for your business

[www.hse.gov.uk/simple-health-safety](http://www.hse.gov.uk/simple-health-safety)





**DO NOT POUR USED OIL  
DOWN DRAINS OR SINKS**



### **IMPORTANT NOTES**

Special attention should be given to the bottom of the top tank so that a layer of sediment is not allowed to build up. As the temperature sensors will not be able to function correctly, a fire could result.

Do not mix different makes or types of frying oil as a reaction can result in a thick flour-like sediment forming in the lower tank which can block the filtering system.

**As it is our policy to improve our machines continuously, we reserve the right to change specifications without prior notice.**



# CONTENTS

---

**Section 1. Introduction**

**Section 2. Dimensions**

**Section 3. Specifications**

**Section 4. Safety**

**Section 5. Installation**

**Section 6. Cleaning Instructions**

**Section 7. Operating conditions/instructions**

**Section 8. Maintenance**

- Spares and service
- Suggested Spares List

## **ENGINEERS INFORMATION**

**Section 9. Electrical Information**

- Setting timer and temperature
- Wiring diagrams

**Section 10. Fault finding checks**

# 1. INTRODUCTION

---

The MONO fryer makes the doughnuts, you make the profits - it's as easy as that. Just set the controls, load a tray and the **MONO Aztec** takes over: Up to 900 doughnuts can be produced every hour with the minimum of supervision.

The MONO Fryer saves on cooking oil and electricity, as only the oil in the vicinity of the frying basket is heated to full working temperature and is thermostatically controlled.

Oil top-up and doughnut turning are fully automatic.

# 2. DIMENSIONS

---

<b>Height:</b>	Frying unit in raised position	1400mm (55")
<b>Width:</b>	Left hand fitted draining board	1905mm (75")
<b>Depth:</b>		970mm (38")

# 3. SPECIFICATIONS

---

**Power:** 12.5 kW; three phase & Neutral



The supply to this machine must be protected by a **30mA RCD**

**Output:** Float frying - up to 900 doughnuts per hour.

**Capacity:** 45 doughnuts per tray.

**Frying tank capacity:**

80 Ltrs (21 gallons).

100 Ltrs Total

**Top up tank To level mark:**

20 Ltrs (5.25 gallons)

**Frying trays:** MONO 762mm x 457mm (30"x18")

**Weight:** 160kg (353lb).

**Noise level:** Less than 85dB.

## 4. SAFETY

---

**EXCEPT FOR OIL FILTERING ALL CLEANING AND MAINTENANCE OPERATIONS MUST BE MADE WITH FRYER DISCONNECTED FROM THE POWER SUPPLY**

1. **Never use the fryer in a faulty condition** and always report any damage.
2. **No-one under the age of 16 may operate** this machine.
3. **No-one under the age of 18 may clean** this machine under any circumstances.
4. **Only trained personnel may remove any part** from this fryer that requires a tool to do so.
5. **Always ensure hands are dry** before touching any electrical appliance (including cable, switch and plug).
6. **All operatives must be fully trained.**
7. **People undergoing training** on the machine **must be under direct supervision.**
8. **Do not operate the machine with any panels removed.**
9. **All guards must be fixed in place** with bolts or screws unless protected by a safety switch.
10. **No loose clothing or jewellery** to be worn while operating the fryer.
11. Switch off power at the mains isolator when fryer is not in use and before carrying out any cleaning or maintenance.
12. **The Bakery Manager or the Bakery Supervisor must carry out daily safety checks on the fryer.**
13. Please read the H.S.E. information sheet contained in this manual.(see pages 5-8)



**Special attention should be given to the bottom of the top tank so that a layer of sediment is not allowed to build up. If the sediment does build up a fire could result as the temperature sensors will not be able to function correctly.**

## 5. INSTALLATION

1. It is recommended that the Aztec Doughnut Fryer should be sited away from any main thoroughfare and that the surrounding floor area should be covered with an appropriate brand of non-slip surfacing.
2. **VENTILATION** should be provided with an extraction canopy to ensure that convected heat and cooking smells are removed from the building. The canopy should extend a minimum of 300mm (12”) beyond each edge of the fryer and have its lowest point between 1980mm (70”) and 2740mm (108”) above the floor.  
  
The extraction canopy should be fitted with a cleanable grease trap.
3. Fittings are provided for the attachment of the draining board.
4. **ELECTRICAL CONNECTION**  
The fryer should be connected to a 25 Amp 3 phase plus neutral isolator at 25 Amp with a BS 88 fuse.



The supply to this machine must be protected by a **30mA RCD**

Aztec doughnut fryers are dispatched with the carrier (1) in the mid-way position to avoid damage during the following check procedure:

5. When turning the main power switch (4) on, watch if carrier (1) moves up or down. **Turn power off immediately** before the carrier reaches top or bottom positions.

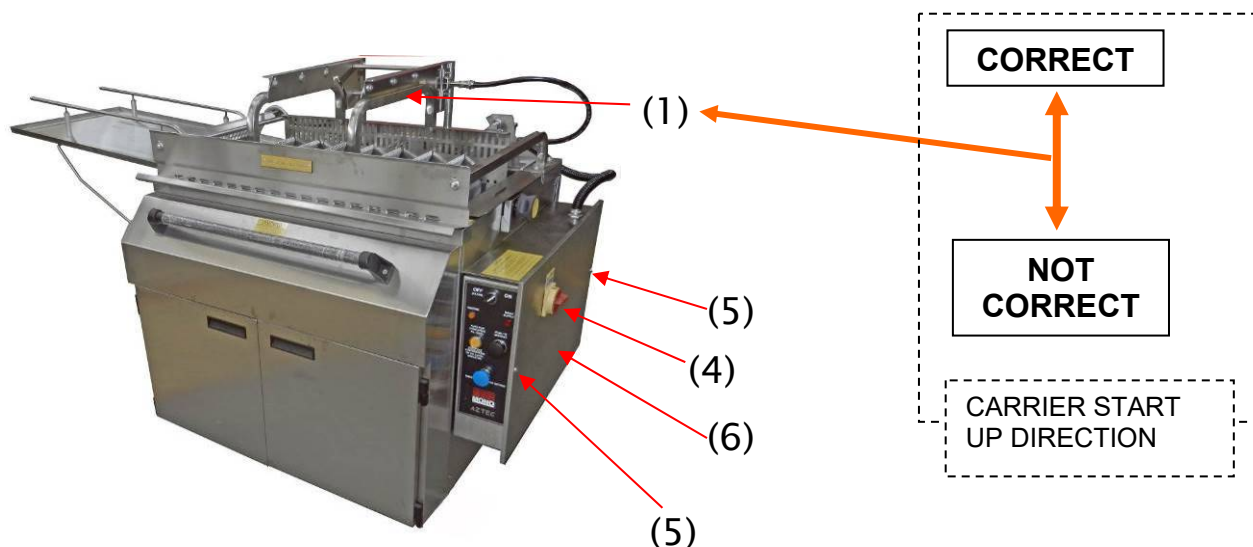

If carrier moves UP, this is **CORRECT**.

If carrier moves DOWN, this is **NOT CORRECT**.

Swap round any two of the phase-carrying wires at main isolator feeding the fryer.

6. Turn main isolator switch (4) to **OFF** (horizontal position).
7. Remove two screws (5).
8. Remove cover (6).
9. Switch element MCB's (in control box) to on position.

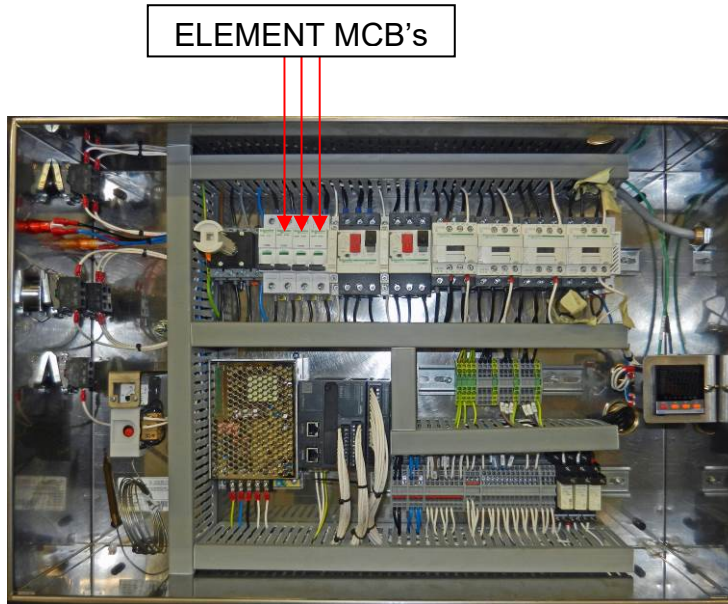

10. Replace cover (6) and screws (5).
11. Switch on main control switch (4).

## **ISOLATION**

To stop the doughnut Fryer in an emergency,  
switch off the mains wall isolator.

## 6. CLEANING INSTRUCTIONS

---



**WARNING:**  
ISOLATE FROM MAINS SUPPLY BEFORE CLEANING AND ALLOW TO COOL. HOT OIL IS DANGEROUS

---

### 6.1 DAILY

Wipe down exterior bodywork with a damp cloth and cleaning fluid.

---



**WARNING:**  
ALLOW OIL TO COOL BEFORE ATTEMPTING TO REMOVE FILTER

---

### 6.2 TO CLEAN OIL FILTER BAG

1. Open front doors.
2. Pull lower tank towards you.
3. Unclip poppers around top edge and remove filter.
4. **Only use hot water to clean filter. Do not use soap or detergent. Do not clean in a dishwasher.**
5. Ensure filter is dry and replace on to filter holding bars, ensuring all poppers are done up.
6. Push lower tank back under machine. Close doors.





### 6.3 REMOVAL OF TURNOVER DEVICE AND SEPARATOR UNIT FOR CLEANING

Before proceeding with the following, the fryer must be allowed to cool and oil drained



1. Lift turnover device off rear bars as shown in photo. (**CAUTION UNIT IS HEAVY**).

2. Turn separator unit adjuster to position 1.



3. Lift separator unit carefully and remove from tank. (**CAUTION UNIT IS HEAVY**).

POSITION 1

4. Lift the Elements carefully and rest on the back of the Fryer.

5. Remove any sediment from the bottom Of the tank & discard.

6. Wipe the tank clean and replace components in reverse order.

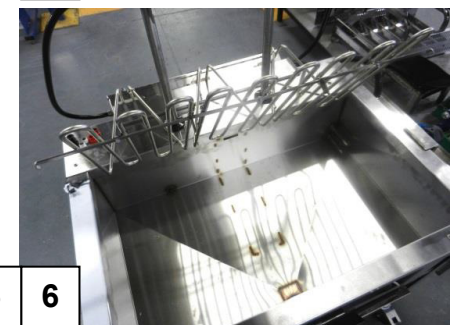
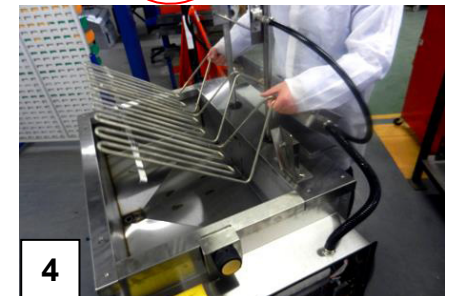
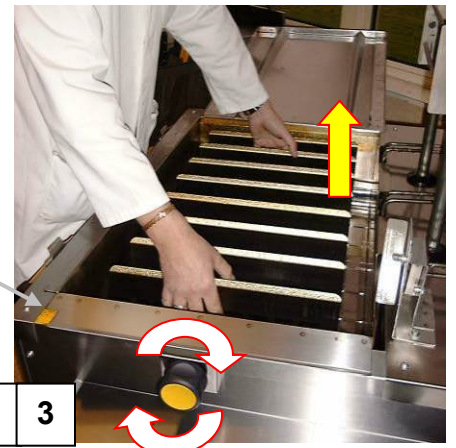

#### **NOTE**

Special attention should be given to the bottom of the top tank so that a layer of sediment is not allowed to build up. If the sediment does build up, a fire could result as the temperature sensors will not be able to function correctly.

# 7. OPERATING INSTRUCTIONS

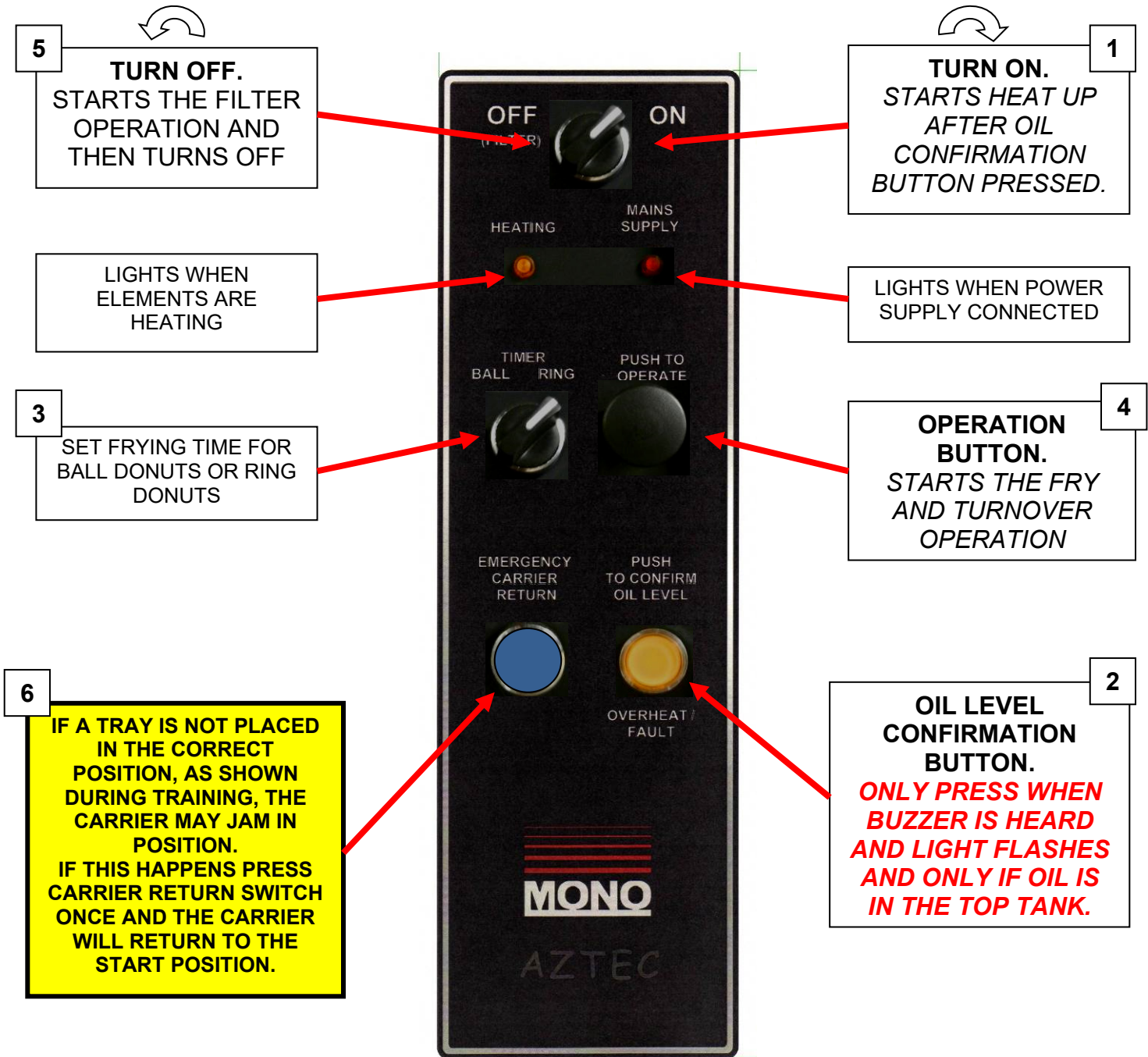

## CONTROL PANEL

## 7.1 FILLING WITH FRYING OIL

- Fill tank with cooking oil until oil is flowing into the bottom tank via the overflow slot at the back of the main tank. Allow flow to stop then pull out lower tank.
- **Fill bottom tank with oil to level shown on the back wall of the tank. Do not overfill or spillage will occur during filtering.**

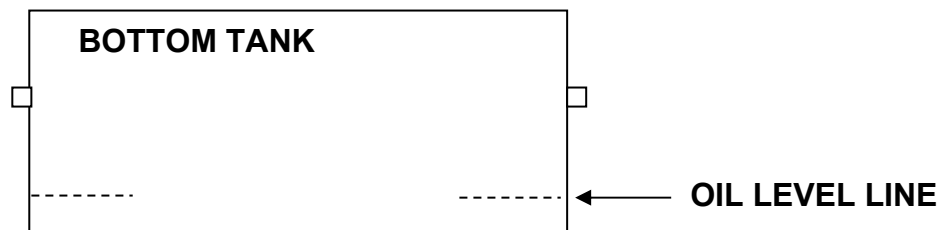

- **Do not mix different makes or types of frying oil** as a reaction can result in a thick flour-like sediment forming in the lower tank which can block the filtering system.

## 7.2 HEATING UP

1. Ensure top control panel switch is in “ON / HEATERS” position 1

2. Turn on main power supply.  
\*\*\*Buzzer sounds\*\*\*

3. If there is oil in top tank, press “OIL LEVEL CONFIRMATION” button. 2

DO NOT PRESS UNLESS THERE IS THE CORRECT AMOUNT  
OF OIL IN THE TOP TANK

Oil will now heat to cooking temperature.

---

### NOTE

Until the oil is heated to cooking temperature the up and down operation will not work.

---



### CAUTION:

ELEMENT HEATING WILL STOP WHILE PUMP IS IN OPERATION. TO PROTECT THE ELEMENTS, ENSURE OIL IS IN TOP TANK AT ALL OTHER TIMES. I.E WHEN TURNING MAIN POWER ON.

## 7.3 ADJUSTMENT OF TURNOVER DEVICE

*Depending on the size or shape of the doughnut being fried, the separator unit must be adjusted.*

1. Turn Knob **(A)** on right hand side of tank, clockwise or anticlockwise.
2. Read off scale **(B)** on left until required position is found.
3. The positions required will have to be determined and recorded for future reference.
4. Generally position **1** is for large products and position **4** is for very small or finger doughnuts.



## 7.4 OPERATION

1. **Set frying time switch** 3 on control panel:

- “BALL” setting is for ball-shaped donuts.
- “RING” setting is for ring-shaped donuts.

---

### NOTE

You must set this frying time switch **again** whenever you want to fry a different type of donut i.e., changing from ball-shaped to ring-shaped donuts. See **page 18** for a view of the control panel with the timer switch.

---

2 **Slide tray into cradle.**

Ensure that the tray is pushed up against the cradle end stops.

**(This must be correct, or the machine will jam).**

3 **Press black button to start frying sequence.** 4

*Cradle will lower tray into the first position and wait before lowering again and turning the doughnuts over. After the preset time the cradle will lift to the top position allowing the doughnuts to drain.*

4 **Slide the tray onto the drainer and insert a fresh tray into the cradle.**

5 Check at regular intervals that the oil level in the lower tank reaches the “Max Oil Level” line engraved on the inside back left corner.



**DO NOT FILL ABOVE THIS LINE** or oil will overflow during filtering.

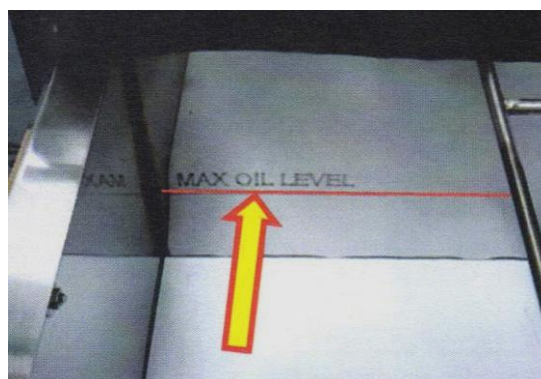

---

### NOTE

IF A TRAY IS NOT PLACED IN THE CORRECT POSITION, AS SHOWN DURING TRAINING, THE CARRIER MAY JAM IN POSITION. IF THIS HAPPENS, A CARRIER RETURN SWITCH (6) CAN BE FOUND AT THE BOTTOM OF THE CONTROL PANEL. PUSH ONCE AND THE CARRIER WILL RETURN TO THE START POSITION.

---

## 7.5 FILTERING WHEN TURNING OFF

1. Ensure lower tank is pushed fully back on runners.
2. Turn top switch to “OFF FILTER” position. 5
3. After 30 seconds the drain valve will open and the return pump will be heard operating.
4. After about 9 minutes the valve will close and the top tank will start to fill up again. When the pump stops the main power can be switched off.

**DO NOT.....**

**DO NOT TURN POWER OFF WHILST PUMP IS OPERATING**

## 7.6 DRAINING COOKING OIL (WHEN REQUIRED)



**WARNING:**  
HOT OIL IS DANGEROUS (ALLOW TO COOL BEFORE DRAINING).

1. Turn on power with top switch in the on position. Wait for buzzer to sound and press yellow button.
2. Turn top switch to “**OFF FILTER**” position. 4  
After 30 seconds the pump will start and oil will start to drain in to lower tank.
3. Hook the drain tube (left side of machine) on to suitable container.
4. Open front doors and pull out lever at top left hand side.
5. When container is full, push lever back in, place tube in new container then pull knob back out.

When drained ensure that the lever is pushed completely in before refilling machine.

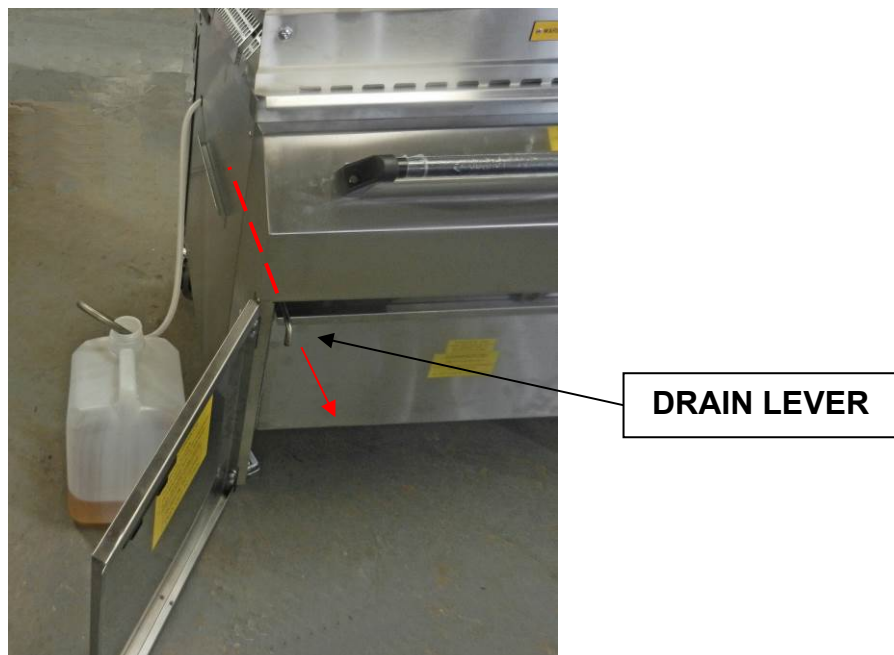



## **FAULT CONDITION INDICATORS**

### **Buzzer sounds continuously / Light flashes**

---- Confirm oil level (push “*OIL LEVEL CONFIRMATION*” button)

---

### **Light flashes/Buzzer pulsates**

---- Lower tank not pushed fully into position.

---

### **Light continuous/Buzzer continuous**

---- Pump overload tripped

**CALL ENGINEER**

---

### **Light on continuously**

---- Overheat thermostat tripped

**CALL ENGINEER**

---

# 8. MAINTENANCE

---



**WARNING**

- This appliance must be maintained at regular intervals. The frequency of maintenance will depend upon your specific use and location. The maximum service interval should be 12 months.
  - Service and maintenance should only be undertaken by suitably qualified, trained, and competent engineers.
  - You must immediately report any damage or defect arising with the appliance.
  - Unsafe equipment is dangerous. Do not use the appliance. Isolate the power supply and contact MONO or your appointed service agent.
- 



The fryer must not be used if bare electrical cables are visible.  
Follow cleaning instructions meticulously.

**Twice A Year.**

Isolate machine from mains supply.



Remove back sheet and grease guide shafts with high temperature grease.

Replace back sheet.

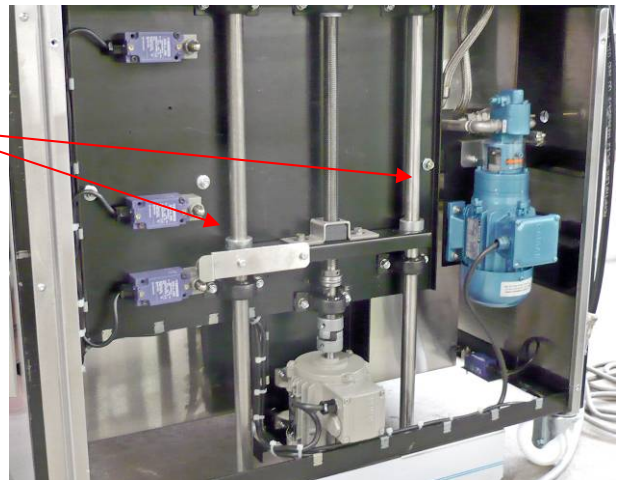

## **IMPORTANT NOTE**



Special attention should be given to the bottom of the top tank so that a layer of sediment is not allowed to build up. If the sediment does build up a fire could result, as the temperature sensors will not be able to function correctly.

Do not mix different makes or types of frying oil as a reaction can result in a thick flour-like sediment forming in the lower tank which can block the filtering system.

## 8.1 SPARES AND SERVICE

If a fault arises, please do not hesitate to contact the Customer Service Department, quoting the **machine serial number** on the silver information plate of the machine and on the front cover of this manual

**MONO**

QUEENSWAY

Swansea West Industrial Estate

Swansea. SA5 4EB UK

Spares +44(0)1792 564039



[www.monoequip.com](http://www.monoequip.com)

Email: [spares@monoequip.com](mailto:spares@monoequip.com)

Main Tel. 01792 561234

Fax. 01792 561016

## 8.2 SUGGESTED SPARES

A900-30-018	FILTER BAG
A900-34-135	3 WAY BALL VALVE
A900-34-389 (A900-34-294)	BALL VALVE - ELECTRICAL OPERATED (MAIN TANK) (BALL VALVE - ELECTRICAL OPERATED (MAIN TANK) up to feb 2011)
B754-74-003	OIL PUMP
B842-62-020	CABLE TIE - (MUST BE STAINLESS STEEL)
B801-12-039	BLACK START BUTTON 
B801-14-002	CONTACT BLOCK 
B801-18-003	HOLE ADAPTOR 
B842-43-001	RED INDICATOR LIGHT
B842-43-002	AMBER INDICATOR LIGHT
B859-74-033	MAIN LIFT MOTOR
B801-03-018	STARTER 0.63-1.0 AMPS (PUMP)
B801-03-020	STARTER 1.0- 1.6 AMPS (UP/DOWN MOTOR)
B801-08-031	CONTACTOR (PUMP, UP/DOWN)
B801-08-021	CONTACTOR (HEATERS)
B801-14-012	AUX. CONTACT – SIDE MTG
B801-18-005	MECHANICAL INTERLOCK
B872-22-008	CIRCUIT BREAKER - TYPE C60HB-125
B872-22-062	CONTROL M.C.B.
B873-30-001	THERMOSTAT – (overheat)
B873-95-004	THERMOCOUPLE
B883-92-001	BUZZER
B801-11-013	LIMIT SWITCH (CARRIER POSITIONS)
B801-11-014	LIMIT SWITCH (BOTTOM TANK POSITION)
B801-99-015	CARRIER SENSOR
B888-30-015	THERMOSTAT – (killerstat)
B906-04-001	ELEMENTS
A900-20-002	CASTOR
A900-20-043	CASTOR (LOCKING)
A900-20-038	RUNNER WHEEL (BOTTOM TANK)
M029-18-03400	DRIVE SHAFT AND NUT ASSY
M029-18-00000	TURN OVER CARRIER ASSY

As it is our policy to improve our machines continuously, we reserve the right to change specifications without prior notice.

# 9. ELECTRICS

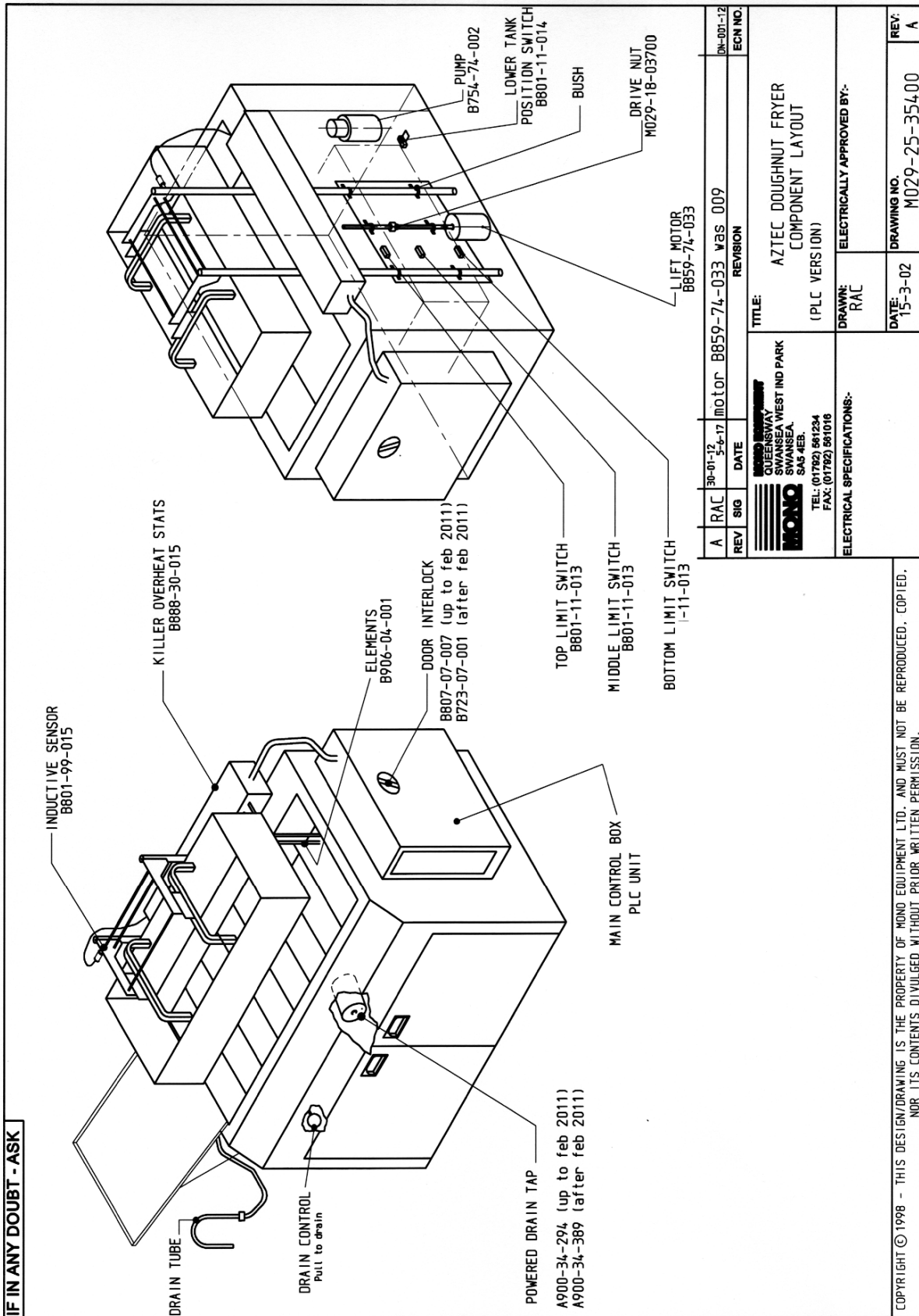

REV	SIG	DATE	DESCRIPTION	REVISION	ECN NO.
A	RAC	30-01-12	Motor B859-74-033 was 009	009	DN-001-12
<p><b>MONO</b>                  QUEENSWAY                  SWANSEA WEST IND PARK                  SWANSEA,                  SAW AEB.                  TEL: (01792) 861234                  FAX: (01792) 861016</p>					
<p><b>MONO</b>                  QUEENSWAY                  SWANSEA WEST IND PARK                  SWANSEA,                  SAW AEB.                  TEL: (01792) 861234                  FAX: (01792) 861016</p>			<p>TITLE:                  AZTEC DOUGHNUT FRYER                  COMPONENT LAYOUT                  (PLC VERSION)</p>		
ELECTRICAL SPECIFICATIONS:-			ELECTRICALLY APPROVED BY:-		
DRAWN: RAC			DRAWING NO. M029-25-354.00		
DATE: 15-3-02			REV: A		

## FOR AUTHORISED/TRAINED ENGINEERS ONLY (USING INSULATED TOOLS)

### ADJUSTING FRY TIMES

To gain entry to the timer setting mode the machine must be in the following mode of operation: -

- A. Carriage should be at the TOP.
- B. Top switch should be in “**ON/HEATERS**” position.
- C. The overheat lamp must not be on.

When the above conditions are correct: -

1. Turn main isolator switch off and remove control box door.
2. Using insulated pointed pliers turn the main isolator on.

#### **WARNING**

**WHILE THE CONTROL BOX COVER IS OFF, TAKE GREAT CARE AND DO NOT ALLOW OTHER PEOPLE NEAR WHERE YOU ARE WORKING. NEVER LEAVE THE MACHINE UNATTENDED WITH THE CONTROL BOX COVER OFF.**

3. Press the **ORANGE** 'Push to Confirm Oil Level' when buzzer sounds then turn the machine to timer setting mode by placing the run/setup switch (right hand side inside the control box) to “**SETUP**” position.
4. **To start the change mode** turn the top switch to “**OFF/FILTER**” position.

*The machine will notify the current setting by flashing the lower overheat lamp and the buzzer will buzz once for every 10 seconds of the set time.*

*e.g., for 60 seconds it will buzz 6 times.*

*When the notification buzzer has stopped the lamp will stay lit and the machine is ready for changes to be made.*

**To set a new time**, press the **ORANGE** 'Push to Confirm Oil Level' button once for every ten seconds required (machine will buzz and flash the overheat lamp for each push).

- **To save the setting press the black operate button.**

e.g., for setting to 90 seconds: - press **ORANGE** button 9 times (listen for 9 buzzes) press operate button to save the setting.

#### *NOTE*

**THE MINIMUM SETTING IS 60 SECONDS** (1 minute)  
*(any settings of less will default to 60 seconds)*

**THE MAXIMUM SETTING IS 180 SECONDS** (3 minutes)  
*(any settings of MORE will default to 180 seconds)*

5. Turn main isolator switch off (Using insulated pointed pliers).
6. Reset **RUN/SETUP** switch (in control box) to “**run**” position.
7. Turn top switch (on front panel) to “**ON/HEATERS**” position.
8. Replace the control box door and turn the main isolator on.

Machine will now run with the new settings.

# FOR AUTHORISED/TRAINED ENGINEERS ONLY

## USING INSULATED TOOLS

### SETTING TEMPERATURE CONTROLLER

TEMPERATURE CONTROLLER- - - Vertex F4

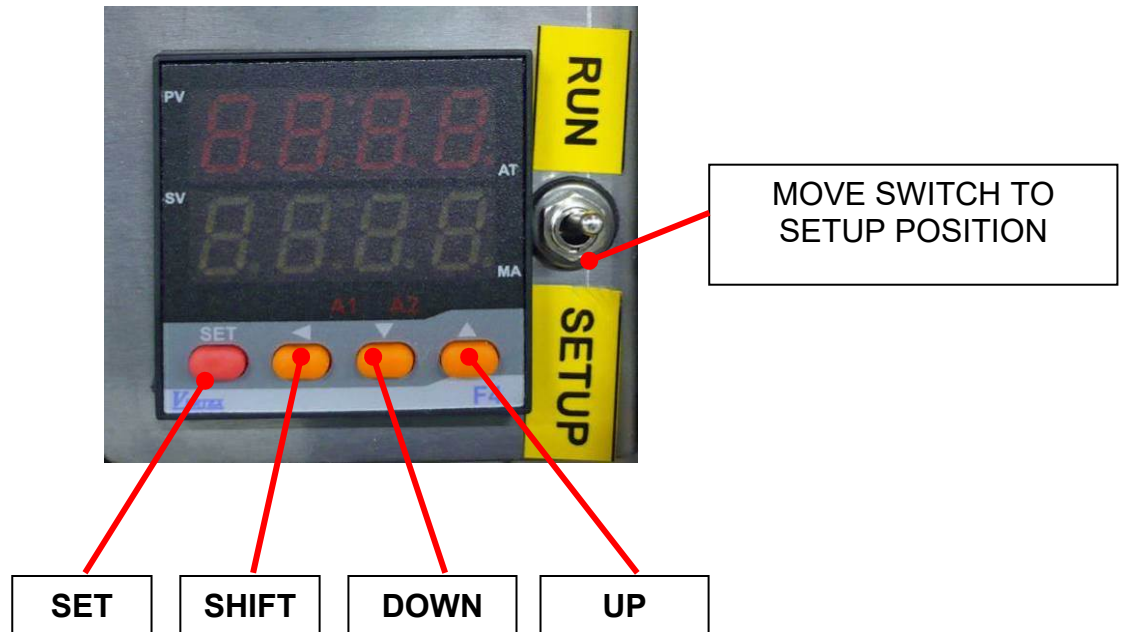

#### Vertex F4 Temperature controller Setup

Move the setting switch to the “SETUP” position.

Press “ SET” + “SHIFT” key for 2 seconds.

Press “UP” arrow until “oPtI” is displayed.

Press “SET”.

“tYPE” is displayed, set to K type using “UP/DOWN” arrows.

Press “SET” “Unit” is displayed, select “°C” using “UP/DOWN” arrows.

Press “SET” until “LoLT” is displayed, set to “0” using “ UP/DOWN” arrows.

Press “SET” , HiLT” is displayed, set to “200” using “ UP/DOWN” arrows.

Press “SET”.

Press “UP” arrow until “LEYL PID” is displayed.

Press “SET” until “Pb” is displayed, set to “0” using “ UP/DOWN” arrows.

Press “SET” until “HYS” is displayed, set to “1” using “ UP/DOWN” arrows.

Press “SET” until “Ct” is displayed, set to “15” using “ UP/DOWN” arrows.



MANUFACTURERS F4 TEMP.CONTROLLER INSTRUCTION MANUAL



F4 Process Controller  
Installation and Operation Guide

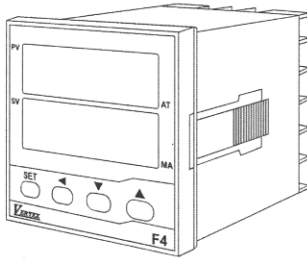

1. Introduction

1.1. Highlight Features

- Space saving, only 55mm panel depth required
- Higher sampling rate (100mS) results in better control performance
- Protect the load from thermal shock (unwanted rapid temperature rise) using the excellent ramp rate feature
- Protect the heating element from excess current during power-up using the soft start function
- Easy to read 0.4" / 10mm LED display showing SV/PV at a glance
- NEMA-4 IP65 front panel protection when used with panel gasket or IP63 without

1.2. Specification

- Input signal :** User programmable, refer to table 1.
- Thermocouple (T/C) : industry standard thermocouple types, J, K, T, E, B, R, S, N, C (ITS-90).
  - Pt100 : Excitation 180uA, 2 or 3 wire connection (ITS-90  $\alpha=0.00385$ ).
  - Voltage : -60mVdc to 60mVdc or -10Vdc to 10Vdc.
  - Current : 0mA to 24mA

**Measuring range :** User programmable. Maximum range refer to table 1.  
**Measuring accuracy :** refer to Table 1. the accuracy is tested under the operating condition of 24°C±3°C.

Input signal	Maximum Range	Accuracy
Thermocouple J	-50 to 1000°C (-58 to 1832°F)	±1°C
Thermocouple K*	-50 to 1370°C (-58 to 2498°F)	±1°C
Thermocouple T	-270 to 400°C (-454 to 752°F)	±1°C
Thermocouple E	-50 to 700°C (-58 to 1832°F)	±1°C
Thermocouple B	0 to 1750°C (32 to 1832°F)	±2°C (Note1)
Thermocouple R	-50 to 1750°C (-58 to 1832°F)	±2°C
Thermocouple S	-50 to 1750°C (-58 to 1832°F)	±2°C
Thermocouple N	-50 to 1300°C (-58 to 1832°F)	±2°C
Thermocouple C	-50 to 1800°C (-58 to 1832°F)	±2°C
Pt100	-200 to 600°C (-58 to 1832°F)	±0.2°C
mA	0.000 to 24.000mA dc	±3µA
mV	-60.00mV to 60.00mV	±0.01mV
Voltage	-10.000 to 10.000Vdc	±1mV

\*Factory Setting

Note 1 : Accuracy is not guaranteed between 0 and 400°C (0 and 752°F) for type B.  
 Table 1 Input Signal

- Sampling rate :** 100mS
- Control Output :**
- Relay output : 2A/240Vac (Resistive load)
  - Pulsed Voltage output : DC 0/24V (Resistive load 250 ohms Min.)
- Control Mode :** PID with auto-tune, P with manual reset or On/Off with hysteresis available.
- Proportional Band : 0.0~300.0% (0.0% = On/Off mode)
  - Integral Time : 0.0~3000 sec.
  - Derivative Time : 0.0~1000 sec.
  - Cycle Time : 1~60 sec.
  - Hysteresis : 0~9999
- Ramp Function :**
- Ramp rate : 0~9999 unit/minute or unit/second (0 = disable the ramp function)
- Alarm Output :** 2A/240Vac (Resistive load)
- Alarm Function :** Energized / De-energized with 0~30000 Sec. / Min. delay
- No alarm
  - Process high alarm
  - Process low alarm
  - Deviation high alarm
  - Deviation low alarm
  - Inside deviation band alarm
  - Outside deviation band alarm
- Alarm Mode :**
- Normal mode
  - Standby mode
  - Latch mode
  - Standby and Latch mode

Communication :

- Interface : Half duplex based on EIA RS-485
- Protocol : ModBus RTU mode
- Data format :
  - Start bit : 1
  - Data bit : 8
  - Parity : None
  - Stop bit : 2
- Baud Rate : 2400, 4800, 9600, 19200 bps
- Power supply : 90~265 Vac, 50/60 Hz.
- Power consumption : 4VA Max.
- Common mode rejection ratio : >80dB.
- Operating temperature : 0 to 50°C
- Humidity : 0 to 85% RH (Non-Condensing)
- Electromagnetic compatibility (EMC) : En 50081-2, En 50082-2
- Dimension : 48x48x55 mm (WxHxD)
- Housing material : ABS plastic, UL 94V0
- Weight : 100g

1.3. Ordering information

Input	Code	Output	Code	Communication	Code	Protection	Code
T/C	T	Relay	R	None	N	None	0
RTD	D	SSR	P	RS-485	C	IP65	5
0mV to 60mV DC	L	2nd Alarm	A				
0 to 10V DC	V						
0 to 24mA DC	M						

2. Installation

2.1. Panel mounting

- Prepare the panel cutout with proper dimensions (45.5<sup>+0.5</sup><sub>-0.5</sub> X 45.5<sup>+0.5</sup><sub>-0.5</sub> mm)
- Insert the controller into the panel cutout from the front of the panel.
- Secure the controller by pushing the mounting bracket into the controller from the rear side.
- Tighten the screws of the mounting bracket slightly if the controller is not firmly secured

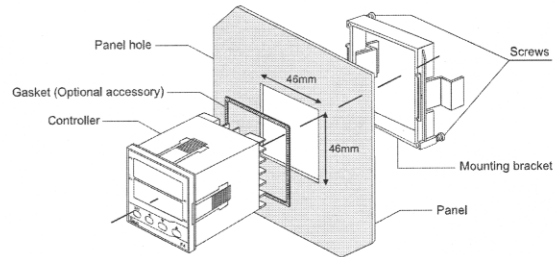

Figure 1. Panel mounting

2.2. Connections and wiring

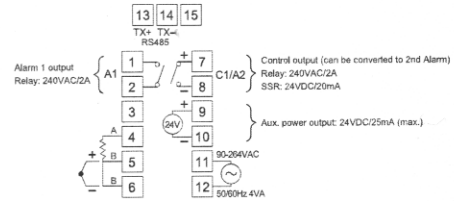

Figure 2. Terminal connections

Wiring precaution:

Inverter, mechanical contact relays, arc welders, and ignition transformers are all common sources of electrical noise in an industrial environment, so always keep signal wires away from those noise-generating devices.

3. Operation

3.1. Front panel description

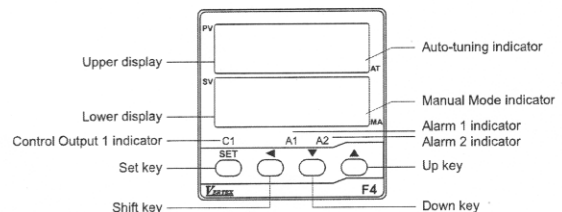

Figure 3. Front panel description

- PV (Upper display) : Display the process Value, parameter index code or error code
- SV (Lower display) : Display the set point value or the set value of parameter
- C1 : Control output 1 indicator
- A1 : Alarm 1 indicator
- A2 : Alarm 2 indicator
- AT : Auto-tuning indicator (The right-most decimal point of upper display)
- MA : Manual mode indicator (The right-most decimal point of lower display)

Keypad description

- SET key : Use to menus navigation and set value registration
- Shift key : Shift the digit of numeral
- Down key : Decreases the parameter value or change the setting
- Up key : Increases the parameter value or change the setting
- SET + Shift key for 2 sec. : Enter set up mode
- SET + up key : Return to PV/SV display
- Shift + Down key on powering up : set all parameters to default setting

3.2.Powering up procedure

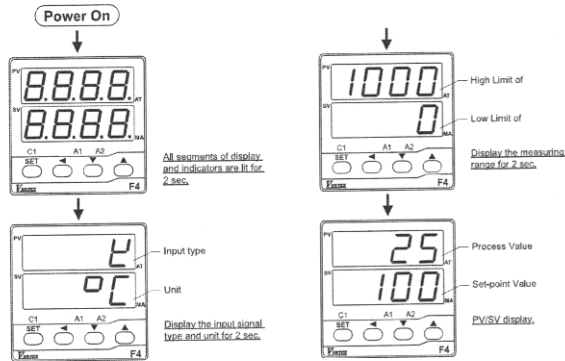

Figure 4. Powering up procedure

3.3.Configuration

3.3.1. Menu Flowchart

After powering up procedure, the controller stays in PV/SV display. The upper display shows the process value (measuring value) and the lower display shows the set point value (target value). All the configurable parameters are located in different levels and can be accessed by keypad operation as shown in figure 5.

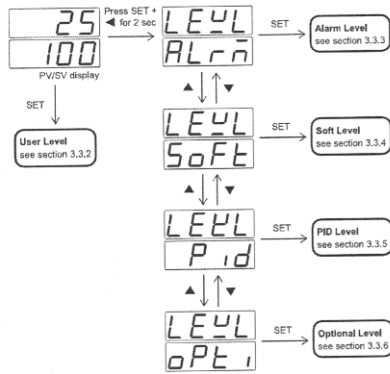

Figure 5. Menu flowchart

3.3.2. User Level

Display	Description	Range	Default	Unit
PV <sub>oF</sub>	Process value offset correction	-1000~1000 ( dP=0000) -100.0~100.0 ( dP=0000) -10.00~10.00 ( dP=0000) -1.000~1.000 ( dP=0000)	0	
oU <sub>tL</sub>	Control output percentage	0.0~100.0%	N/A	%
rUn	Control mode	oFF : Off oN : On Rt1 : AT1 Rt2 : AT2 MAn : Man	On	-

Process value offset correction

The value to be added to the PV to correct the sensor offset error.

Control output percentage.

In Auto mode ( rUn = oN ), it shows the percentage of power applied to the control output. In Manual mode ( rUn = MAn ), the upper display will show the process value (PV) and "oU<sub>tL</sub>" alternately and the "MA" indicator is lit. The value of percentage can be changed manually.

Control mode

Select the control mode to be

- Off – Standby mode. Both control output and alarm are turned off.
- On – Auto mode (closed loop control). In this mode, the control output percentage is determined by PID algorithm or ON/OFF action.
- AT1 – Auto-tuning mode 1. In this mode, the controller will tune the PID parameters automatically at SV. The process will oscillate around the SV during AT1 process (Figure 6). Use AT2 mode if overshooting beyond the normal process is likely to cause damage.
- AT2 – Auto-tuning mode 2. In this mode, the controller will tune the PID parameters automatically at (SV-10%). The process will oscillate around (SV-10%) during AT2 process (Figure 6).
- Man – Manual mode (open loop control). In this mode, the control output can be set manually.

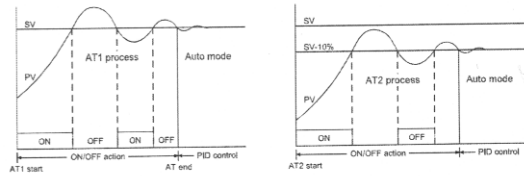

Figure 6. Auto-tuning Process

3.3.3. Alarm Level

Display	Description	Range	Default	Unit
R1SP	Alarm 1 set-point	-1999~9999 ( dP=0000) -199.9~999.9 ( dP=000.0) -19.99~99.99 ( dP=00.00) -1.999~9.999 ( dP=0.000)	10	unit
R1HY	Alarm 1 hysteresis	0~9999 ( dP=0000) 0~999.9 ( dP=000.0) 0~99.99 ( dP=00.00) 0~9.999 ( dP=0.000)	0	unit
R1FU	Alarm 1 function	RoFF : A.oFF RH : A.Hi RLo : A.Lo RdH : A.diH RdL : A.diL RbdH : A.bdH RbdL : A.bdL boFF : b.oFF bHi : b.Hi bLo : b.Lo bdH : b.diH bdL : b.diL bbdH : b.bdH bbdL : b.bdL	A.diH	N/A
R1m	Alarm 1 mode	oNE : None Stdy : Stdy LRtH : LRtH SLtA : SLtA	None	N/A
R1dt	Alarm 1 delay time	oFF, 00.01~99.59	oFF	HH.MM/MM.SS
R2SP	Alarm 2 set-point*	Same as Alarm1 set-point	10	Unit
R2HY	Alarm 2 set hysteresis*	Same as Alarm1 set hysteresis	0	Unit
R2FU	Alarm 2 function*	Same as Alarm1 function	A.diL	N/A
R2m	Alarm 2 mode*	Same as Alarm1 mode	None	N/A
R2dt	Alarm 2 delay time*	Same as Alarm1 delay time	oFF	HH.MM/MM.SS

\*All the alarm 2 parameters are only shown when the control output is set as 2nd alarm action.

Alarm 1 set-point, Alarm 2 set-point

The set point of alarm even

Alarm 1 hysteresis, Alarm 2 hysteresis

The hysteresis of alarm action

Alarm 1 function, Alarm 2 function

Select the alarm function

- A.oFF – Alarm action off
- A.Hi – Process high alarm with Form A contact
- A.Lo – Process low alarm with Form A contact
- A.diH – Deviation high alarm with Form A contact
- A.diL – Deviation low alarm with Form A contact
- A.bdH – Deviation band high alarm with Form A contact
- A.bdL – Deviation band low alarm with Form A contact
- b.oFF – Alarm action off
- b.Hi – Process high alarm with Form B contact
- b.Lo – Process low alarm with Form B contact
- b.diH – Deviation high alarm with Form B contact
- b.diL – Deviation low alarm with Form B contact
- b.bdH – Deviation band high alarm with Form B contact
- b.bdL – Deviation band low alarm with Form B contact

Alarm indicator lite

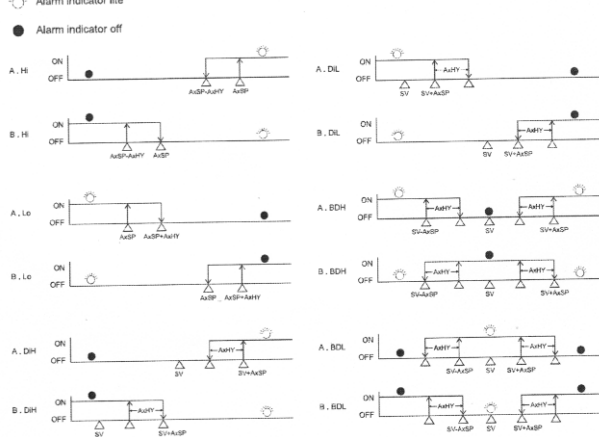

Figure 7. Alarm function

**Alarm 1 mode, Alarm 2 mode**

Select the alarm mode as

None – Disable the alarm mode

Stdy – Standby mode. When selected, prevents an alarm on power up. The alarm is active after alarm condition has been cleared and then alarm occurs again.

LATH – Latch mode. When selected, the alarm output and indicator latch as the alarm occurs. The alarm output and indicator will not change its state even if the alarm condition has been cleared unless the power is off.

StLA – Both standby and Latch mode are applied.

**Alarm 1 delay time, Alarm 2 delay time**

Alarm delay time is set to postpone the alarm action by the setting time.

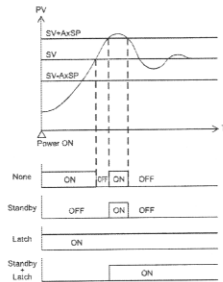

Figure 8. Alarm Mode

**3.3.4. Soft Level**

Display	Description	Range	Default	Unit
rRAMP	Ramp rate	oFF, 1-9999 (0.1-999.9)	oFF	
SOFt	Soft start time	oFF, 00.01-99.59	oFF	

**Ramp rate**

The controller can act as either a fixed set point controller or as a single ramp controller. If the ramp rate is set to a value other than "oFF", the process will increase or decrease at the setting rate during initial power up or with set point change. The ramp rate is in degree per min. or sec. depends on the time scaleset in PTME.

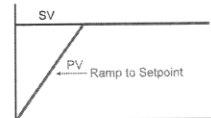

Figure 9. Ramp Function

**Soft start time**

Soft start time can be programmed in situation where 100% output is not allowed at power up. The time duration for the output to rise from 0% to 100% is defined as soft start time.

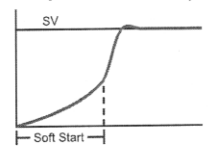

Figure 10. Soft Start

**3.3.5. PID Level**

Display	Description	Range	Default	Unit
Pt	Proportional band	0.0-300.0	5.0	%
tI	Integral time	oFF, 1-3000	240	Sec.
tD	Derivative time	oFF, 1-1000	60	Sec.
rR	Manual reset	0.0-51.0	0.0	%
AR	Anti-reset windup	0.0-100.0	50.0	%
HYS	Hysteresis for ON/OFF control	0-1000 (0.0-100.0)	0	unit
Ct	Cycle time	1-60	15	Sec.

**Proportional band**

Set the proportional band in percentage of SPAN (High limit - Low limit). It can be set automatically by auto-tuning process.

**Integral time**

Set the integral time constant in repetitions per second. It can be set automatically by auto-tuning process.

**Derivative time**

Set the derivative time constant in second. It can be set automatically by auto-tuning process.

**Manual reset**

For PID control, this value is set automatically after auto-tuning process. For P control, it is used to compensate the deviation between process value and set point.

**Anti-reset windup**

The anti-reset windup (ARW) inhibits the integral action until the process value is within the band thus reducing overshoot on start-up. The ARW can be set automatically by auto-tuning process and then can be changed manually if required

**Hysteresis for ON/OFF control**

In ON/OFF control (Proportional band set to 0.0%), the control output turns On/Off with respect to the set point. Therefore, the control output would change frequently in response to a slight change in process value. To prevent this, a hysteresis is provided in the ON/OFF control.

**Cycle time**

Set the control output cycle time. It is recommended to set to 15 sec. for Relay output and set to 1 sec. for pulsed voltage output.

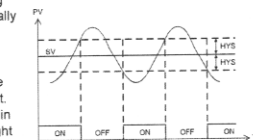

Figure 11. ON/OFF Control Action

**3.3.6. Option Level**

Display	Description	Range	Default	Unit
TYPE	Input signal type	J : J type K : K type T : T type E : E type b : B type r : R type S : S type n : N type C : C type d-Pt : PT100 (DIN) J-Pt : PT100 (JIS) mA : mA mV : mV V : V	K type	N/A
SCAL	Low scale for linear input	-1999-9999	0	Unit
SCAH	High scale for linear input	-1999-9999	1000	Unit

CUT	Cut-off function	None Lo : Low Hi : High HiLo : High/Low	None	N/A
Unit	Unit	°C °F Engineer	°C	N/A
dP	Decimal point	0000 00.00 (for linear input signal only) 0.000 (for linear input signal only)	0000	N/A
RCt	Control action	Dir : Dir Rev : Rev	Rev	N/A
LoL	Low limit	Refer to table 1.	0	Unit
HiL	High limit	Refer to table 1.	1000	Unit
Flt	Digit filter	0.0-99.9	0.0	Sec.
PtSc	Time scale	HH.MM MM.SS	HH.MM	N/A
ErOP	Error protection	0000 0001 0010 0011	0000	N/A
LoLk	Security lock	0000 0001 0010 0011 0100 0101 0110	0110	N/A
SzOF	Setpoint offset	-1999-9999 ( dP=0000) -199.9-999.9 ( dP=000.0) -19.99-99.99 ( dP=00.00) -1.999-9.999 ( dP=0.000)	0	Unit
id	Communication ID	1-247	247	N/A
bRd	Baud rate	247 : 2.4K 487 : 4.8K 967 : 9.6K 1927 : 19.2K	19.2K	bps

**Input signal type**

Select the input signal type. The available input signal types are :

Thermocouple : J K T E B R S N C

RTD : PT100 (JIS standard) or PT100 (DIN standard)

Linear : 0-24mA, -60-60 mV or 0-10 V

Please note that the internal gaps on the main board of F4 controller should be configured in accordance with input signal.

	G1	GA1	GB1	GY
Thermocouple	Linked	Linked	Open	Open
RTD	Open	Linked	Open	Open
0-24 mA	X	Linked	Open	Linked
-60-60 mV	X	Linked	Open	Open
-10-10 V	X	Open	Linked	Open

X : don't care

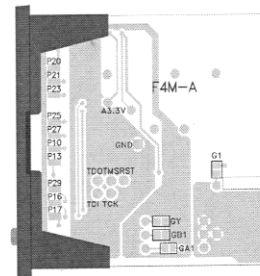

Figure 12. Gaps Allocation

**Low scale for linear input**

Select the low scale corresponding to low linear input signal. The default low linear input signal (INL) for mA, mV and V is 4.00mA, 0.00mV and 0.00V separately. This parameter is only showed when the input signal type is set to linear. (See also the cut-off function for further detail)

**High scale for linear input**

Select the high scale corresponding to high linear input signal. The default low linear input signal (INH) for mA, mV and V is 20.00mA, 50.00mV and 10.00V separately. This parameter is only showed when the input signal type is set to linear. (See also the cut-off function for further detail)

**Cut-off function**

The Cut-off function is used to limit the process value of linear input signal within the boundary whenever the input signal is out of the scale. The cut-off function can be set to "Low", "High" or "High/Low", set to "None" disable the cut-off function. The cut-off function has no effect for input signal other than line type and is only showed when the input signal type is set to linear.

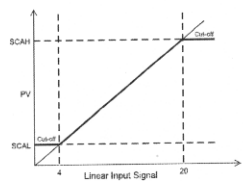

Figure 13. Scale and Cut-off Function

PV scale calculation :  $PV = \frac{IN - INL}{INH - INL} (SCAH - SCAL) + SCAL$  where IN is the input signal.

Example : For a 4~20mA input signal, the INL=4.00mA INH=20.00mA. Set SCAL=0.0 and SCAH=100.0 (Of course, you may select other value for Decimal point to alter the resolution).  
 For a 12mA input, the PV will be 50.0 for a 12mA input.  
 For a 22mA input, the PV will be 112.5 with cut-off function set to "None" or 100.0 with cut-off function set to "High" or "High/Low".  
 For a 0mA input, the PV will be -25.0 with cut-off function set to "None" or 0.0 with cut-off function set to "Low" or "High/Low".

Unit

Select the process value indication in °C or °F when the input signal type is set to thermocouple or PT100. Select engineer unit for linear input (mA, mV or V).

Decimal point

Select the decimal point position. The setting 00.00 and 0.000 is available for linear input only.

Control action

Dir – Direct action used for cooling process

Rev – Reverse action used for heating process

Low limit

Set the low limit of measuring range. When the PV goes below the low limit, the PV display flashing indicates a low limit error. The control output and alarm will be set according to the Error Protection.

High limit

Set the high limit of measuring range. When the PV goes beyond the high limit, the PV display flashing indicates a high limit error. The control output and alarm will be set according to the Error Protection.

Digit filter

Set the time constant for digit filter (the first order filter). It is useful when the process value is too unstable to be read.

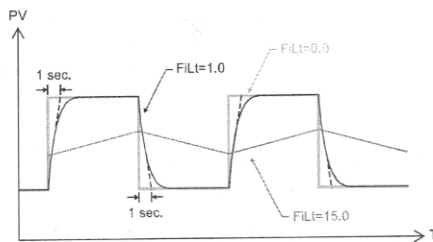

Figure 14. Digit Filter

Time scale

Set the time scale used for alarm delay time and ramp rate.

HH.MM – The alarm delay time is in hour and minute. The ramp rate is in per minute.

MM.SS – The alarm delay time is in minute and second. The ramp rate is in per second.

Error protection

Set the control output and alarm status whenever an error occurred. (refer to 4 Error Message)

Error protection	Alarm	Control output
0000	OFF	OFF
0001	OFF	ON
0010	ON	OFF
0011	ON	ON

Security lock

The security lock is useful to lock out the parameters from unauthorized changed

Security lock	Description
0000	Only the security lock is open to change, all other parameters are locked
0001	Only the security lock and set point value is changeable. all the other parameters are locked
0010	The user level is open to change.
0011	The user and alarm levels are open to change.
0100	The user, alarm, and soft levels are open to change.
0101	The user, alarm soft and PID levels are open to change.
0110	All parameters are open to change.

Set point offset

Shift the set point value with an offset. The actual control target is shifted with this offset from set point value but not added to SV display.

Communication ID

Set the ID number in the communication network

Baud rate

Set the communication baud rate.

**4. Error Message**

Display	Error Description	Correction
oPEr	Sensor break or open	1. Check the sensor is connected and input signal type is selected correctly. 2. Replace the sensor
RdEr	Input signal has out of A/D converter range	1. Check the sensor is connected and input signal type is selected correctly. 2. Replace the sensor. 3. Return to the supplier for repairing
EPEr	The content of EEPROM is corrupt	1. Return to default setting by pressing shift and down keys simultaneously while power on. And reconfigure the parameters 2. Return to the supplier for repairing
REEr	Fail to complete the auto-tuning process within 2 hours	1. Retry the auto-tuning again. 2. Improve the control process to have fast response or use manual tuning instead of auto-tuning
Flashing	The PV is out of range	1. Check the sensor is connected and input signal type is selected correctly 2. Check the polarity of sensor is connected correctly 3. Check the high/low limit is set properly. 4. Replace the sensor

**TEMPERATURE CONTROLLER (F4)  
DRAIN VALVE.**

**WIRING DIAGRAMS**

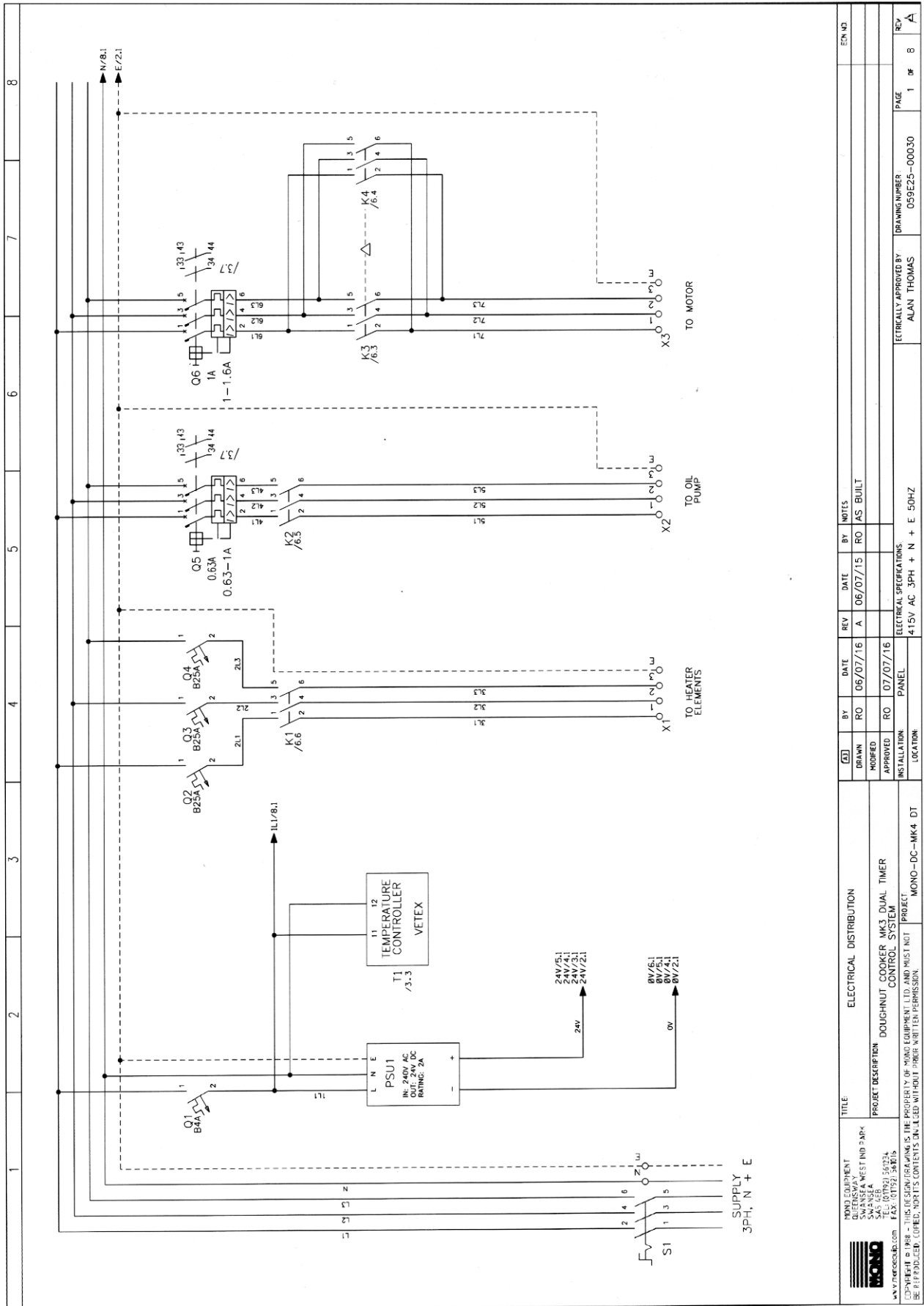

MONO EQUIPMENT QUEENSWAY INDUSTRIAL PARK SWANSEA SAWAMSEA SA 31 01 9921 56724 www.monocooker.com FAX: 01792 348715		TITLE ELECTRICAL DISTRIBUTION		REV		DATE		BY		NOTES		ECN NO.	
PROJECT DESCRIPTION DOUGHNUT COOKER MK3 DUAL TIMER CONTROL SYSTEM		DRAWN RO		06/07/16		A		06/07/15		RO		JAS BUILT	
PROJECT MONO-DC-MK4 DT		APPROVED RO		07/07/16								ELECTRICALLY APPROVED BY ALAN THOMAS	
PROJECT LOCATION MONO-DC-MK4 DT		INSTALLATION		PANEL		ELECTRICAL SPECIFICATIONS 415V AC 3PH + N + E 50HZ		DRAWING NUMBER 059E25-00030		PAGE 1 of 8		REV A	

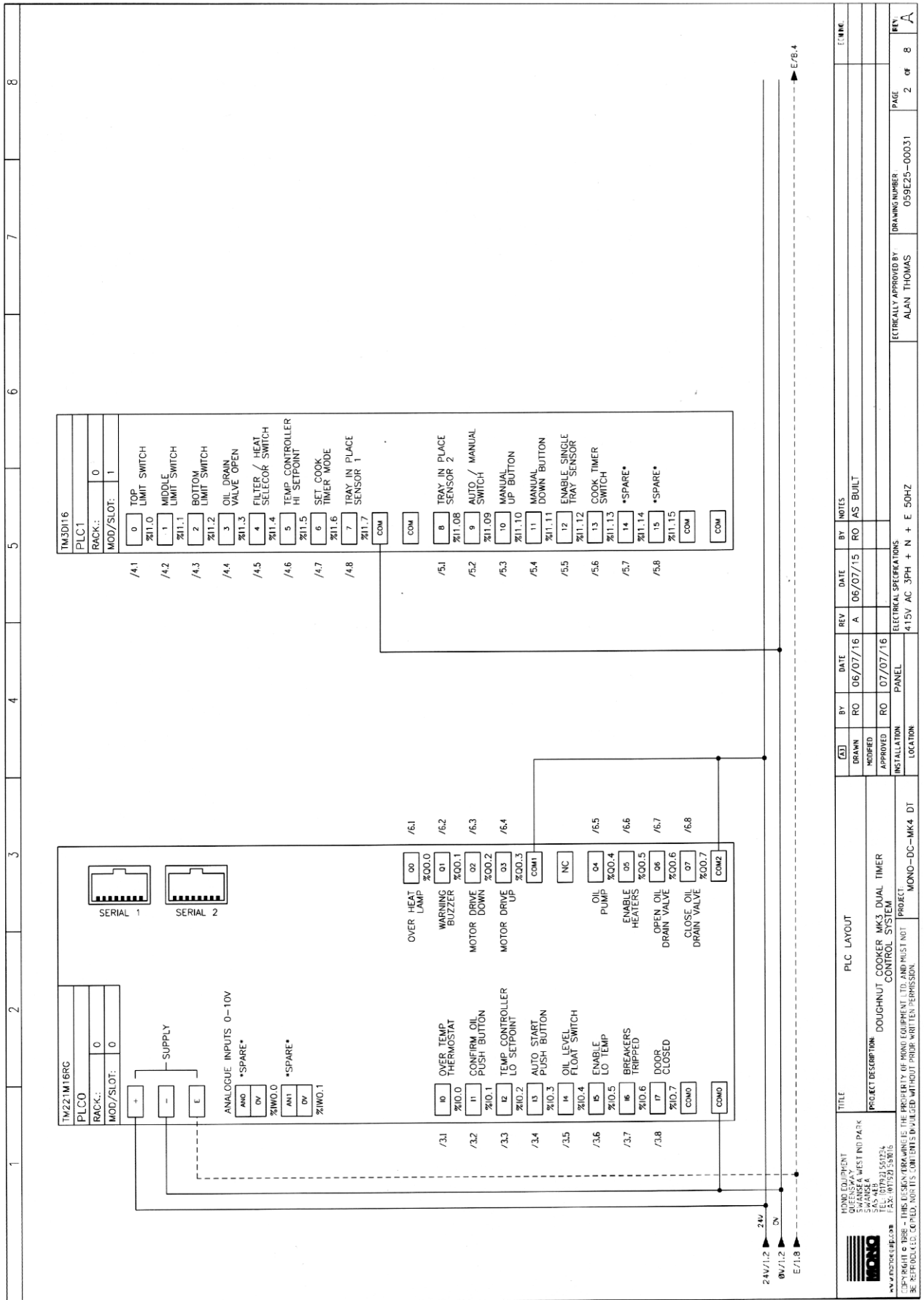

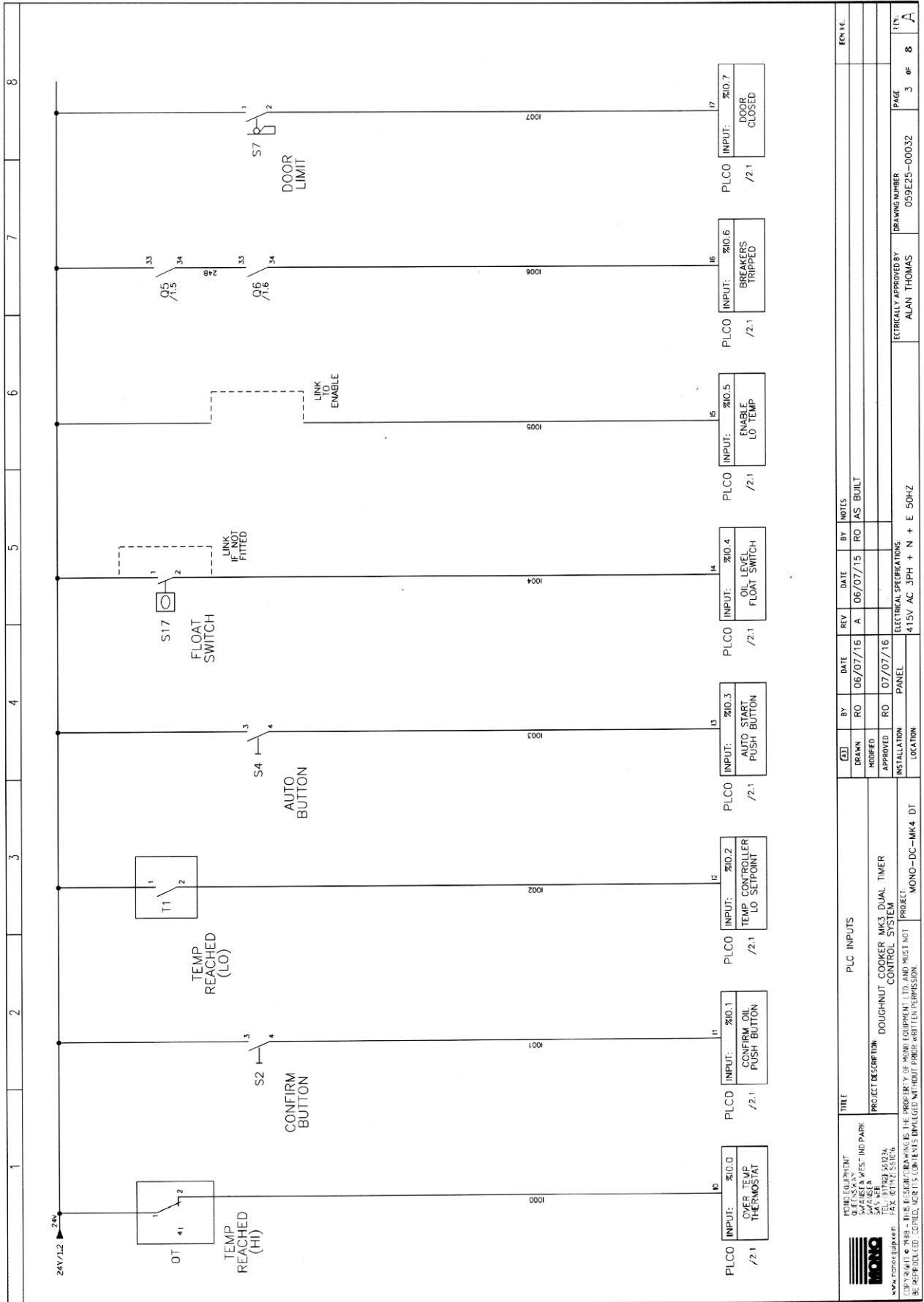

REV	DATE	BY	NOTES
A	06/07/16	RO	AS BUILT
	07/07/16	RO	ELECTRICAL SPECIFICATIONS
			415V AC 3PH + N + E 50HZ

REV	DATE	BY	NOTES

REV	DATE	BY	NOTES

REV	DATE	BY	NOTES

REV	DATE	BY	NOTES

REV	DATE	BY	NOTES

REV	DATE	BY	NOTES

REV	DATE	BY	NOTES

REV	DATE	BY	NOTES

REV	DATE	BY	NOTES

REV	DATE	BY	NOTES

REV	DATE	BY	NOTES

REV	DATE	BY	NOTES

REV	DATE	BY	NOTES

REV	DATE	BY	NOTES

REV	DATE	BY	NOTES

REV	DATE	BY	NOTES

REV	DATE	BY	NOTES

REV	DATE	BY	NOTES

REV	DATE	BY	NOTES

REV	DATE	BY	NOTES

REV	DATE	BY	NOTES

REV	DATE	BY	NOTES

REV	DATE	BY	NOTES

REV	DATE	BY	NOTES

REV	DATE	BY	NOTES

REV	DATE	BY	NOTES

REV	DATE	BY	NOTES

REV	DATE	BY	NOTES

REV	DATE	BY	NOTES

REV	DATE	BY	NOTES

REV	DATE	BY	NOTES

REV	DATE	BY	NOTES

REV	DATE	BY	NOTES

REV	DATE	BY	NOTES

REV	DATE	BY	NOTES

REV	DATE	BY	NOTES

REV	DATE	BY	NOTES

REV	DATE	BY	NOTES

REV	DATE	BY	NOTES

REV	DATE	BY	NOTES

REV	DATE	BY	NOTES

REV	DATE	BY	NOTES

REV	DATE	BY	NOTES

REV	DATE	BY	NOTES

REV	DATE	BY	NOTES

REV	DATE	BY	NOTES

REV	DATE	BY	NOTES

REV	DATE	BY	NOTES

REV	DATE	BY	NOTES

REV	DATE	BY	NOTES

REV	DATE	BY	NOTES

REV	DATE	BY	NOTES

REV	DATE	BY	NOTES

REV	DATE	BY	NOTES

REV	DATE	BY	NOTES

REV	DATE	BY	NOTES

REV	DATE	BY	NOTES

REV	DATE	BY	NOTES

REV	DATE	BY	NOTES

REV	DATE	BY	NOTES

REV	DATE	BY	NOTES

REV	DATE	BY	NOTES

REV	DATE	BY	NOTES

REV	DATE	BY	NOTES

REV	DATE	BY	NOTES

REV	DATE	BY	NOTES

REV	DATE	BY	NOTES

REV	DATE	BY	NOTES

REV	DATE	BY	NOTES

REV	DATE	BY	NOTES

REV	DATE	BY	NOTES

REV	DATE	BY	NOTES

REV	DATE	BY	NOTES

REV	DATE	BY	NOTES

REV	DATE	BY	NOTES

REV	DATE	BY	NOTES

REV	DATE	BY	NOTES

REV	DATE	BY	NOTES

REV	DATE	BY	NOTES

  

REV	DATE	BY	NOTES

  

REV	DATE	BY	NOTES



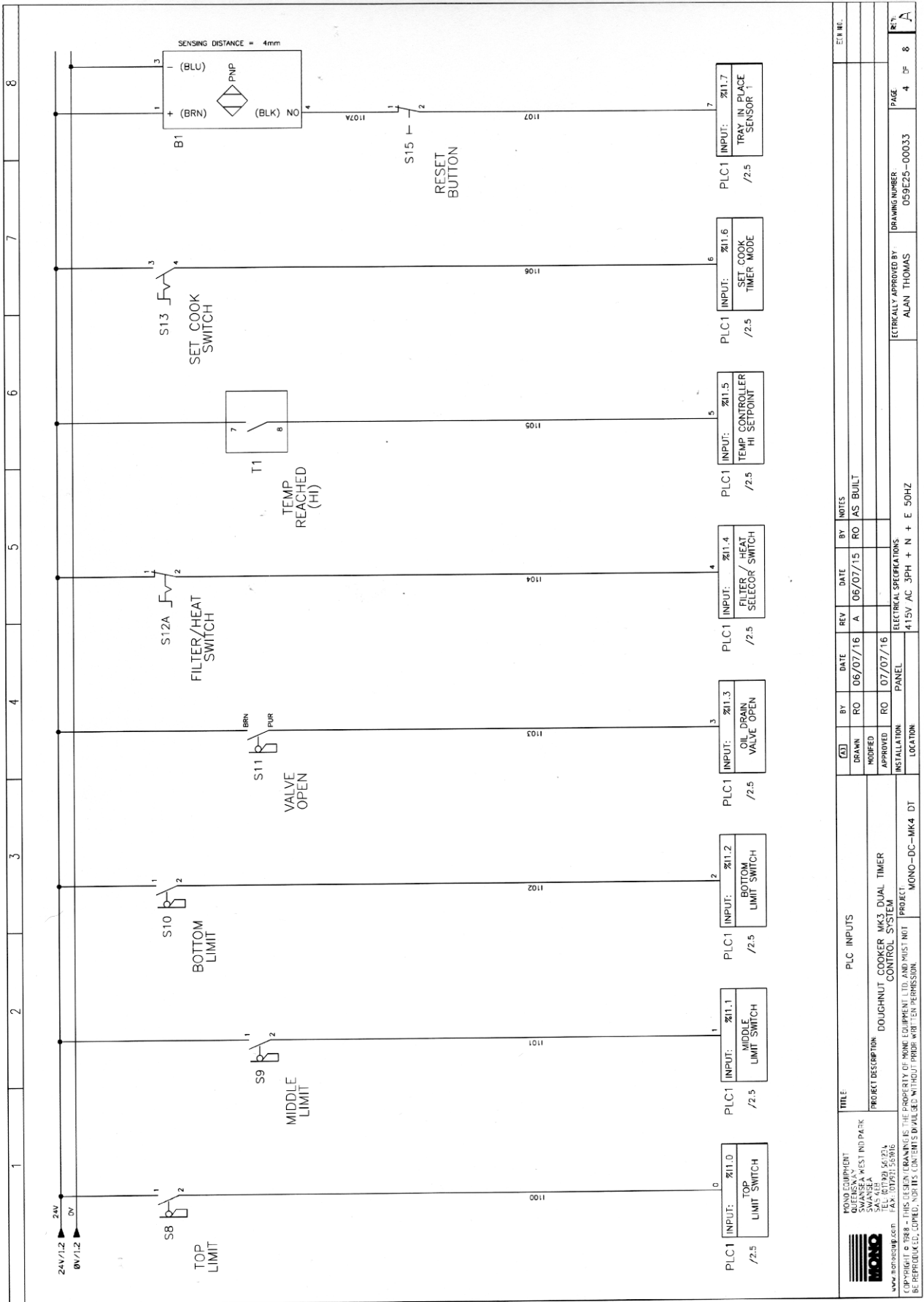

POND EQUIPMENT		TITLE		PLC INPUTS		REV		DATE		BY		NOTES		ETB NO.	
POND EQUIPMENT SWANSEA WEST IND PARK SWANSEA TEL: (01792) 467214 FAX: (01792) 25916 www.pondequip.com		PROJECT DESCRIPTION		DOUGHNUT COOKER MK3 DUAL TIMER CONTROL SYSTEM		DRAWN		06/07/16		RO		AS BUILT			
COPYRIGHT © 1988 - THIS DESIGN (DRAWING) IS THE PROPERTY OF POND EQUIPMENT LTD. AND MUST NOT BE REPRODUCED, COPIED, OR ITS CONTENTS DISCLOSED WITHOUT PRIOR WRITTEN PERMISSION.		PROJECT		MONO-DC-MK4 DT		MODIFIED		07/07/16		RO		ELECTRICALLY APPROVED BY		DRAWING NUMBER	
		LOCATION		PANEL		APPROVED		ELECTRICAL SPECIFICATIONS		415V AC 3PH + N + E 50HZ		ALAN THOMAS		059E25-00033	
						INSTALLATION						PAGE		REV	
												4		8	
												A			

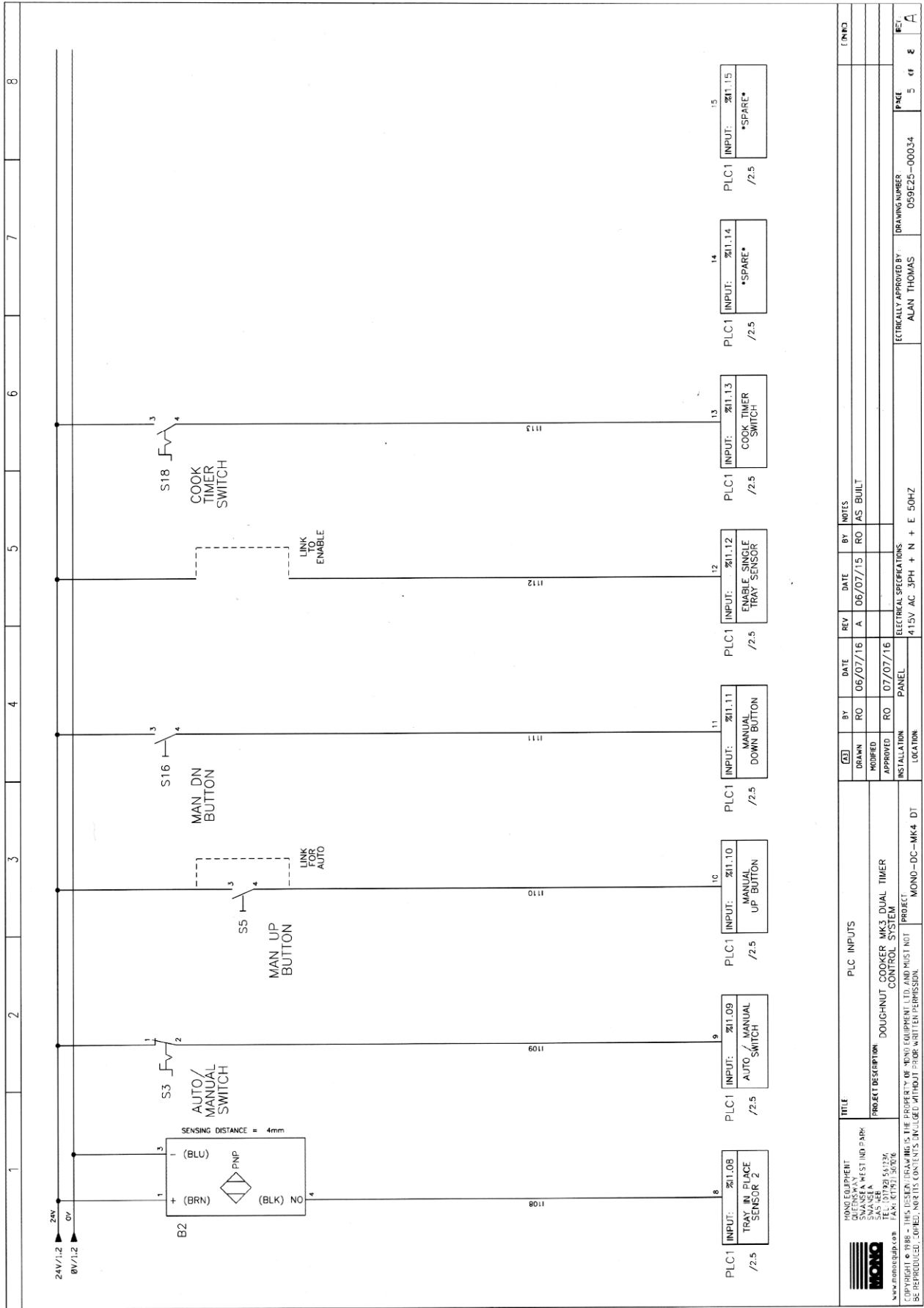

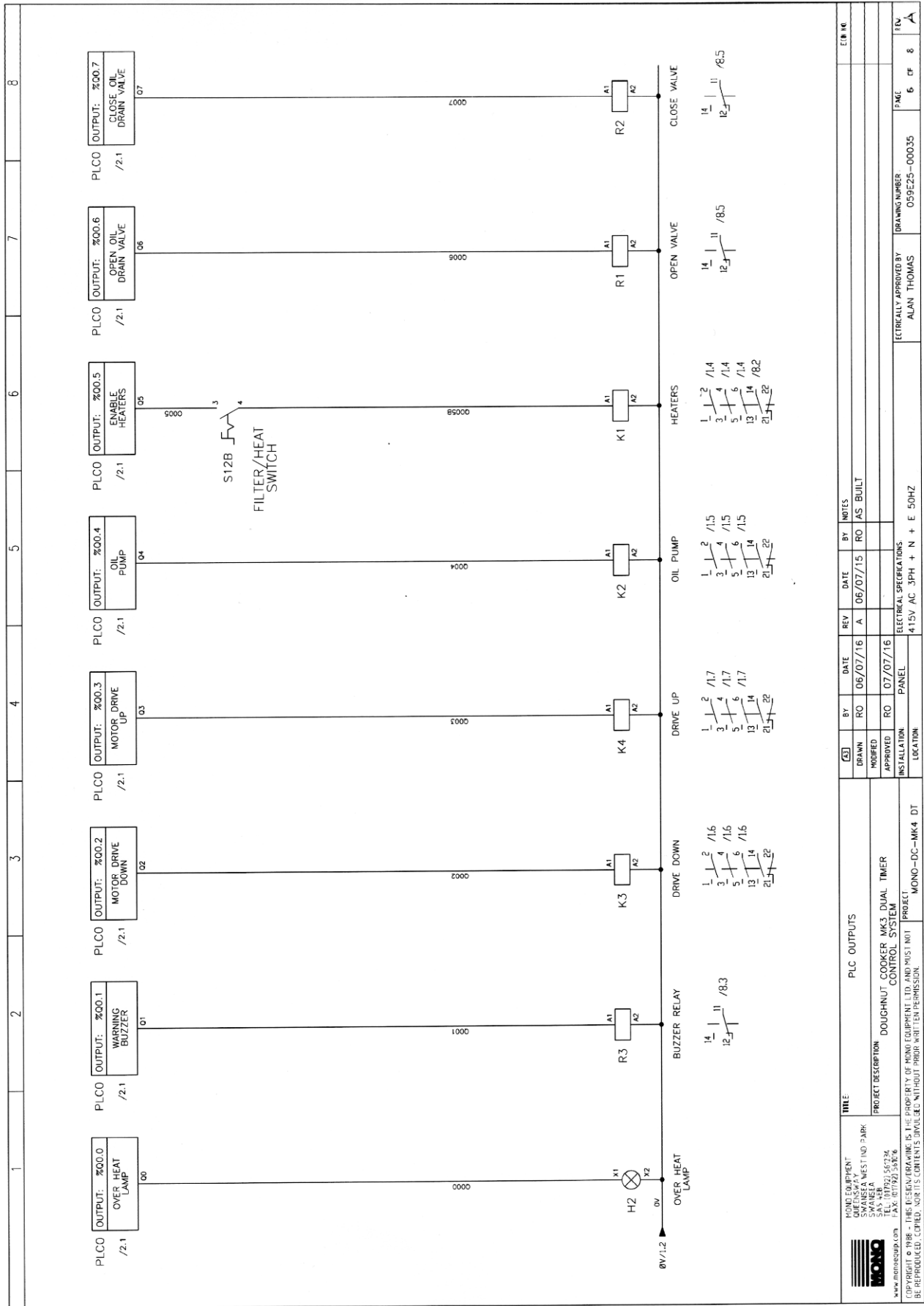



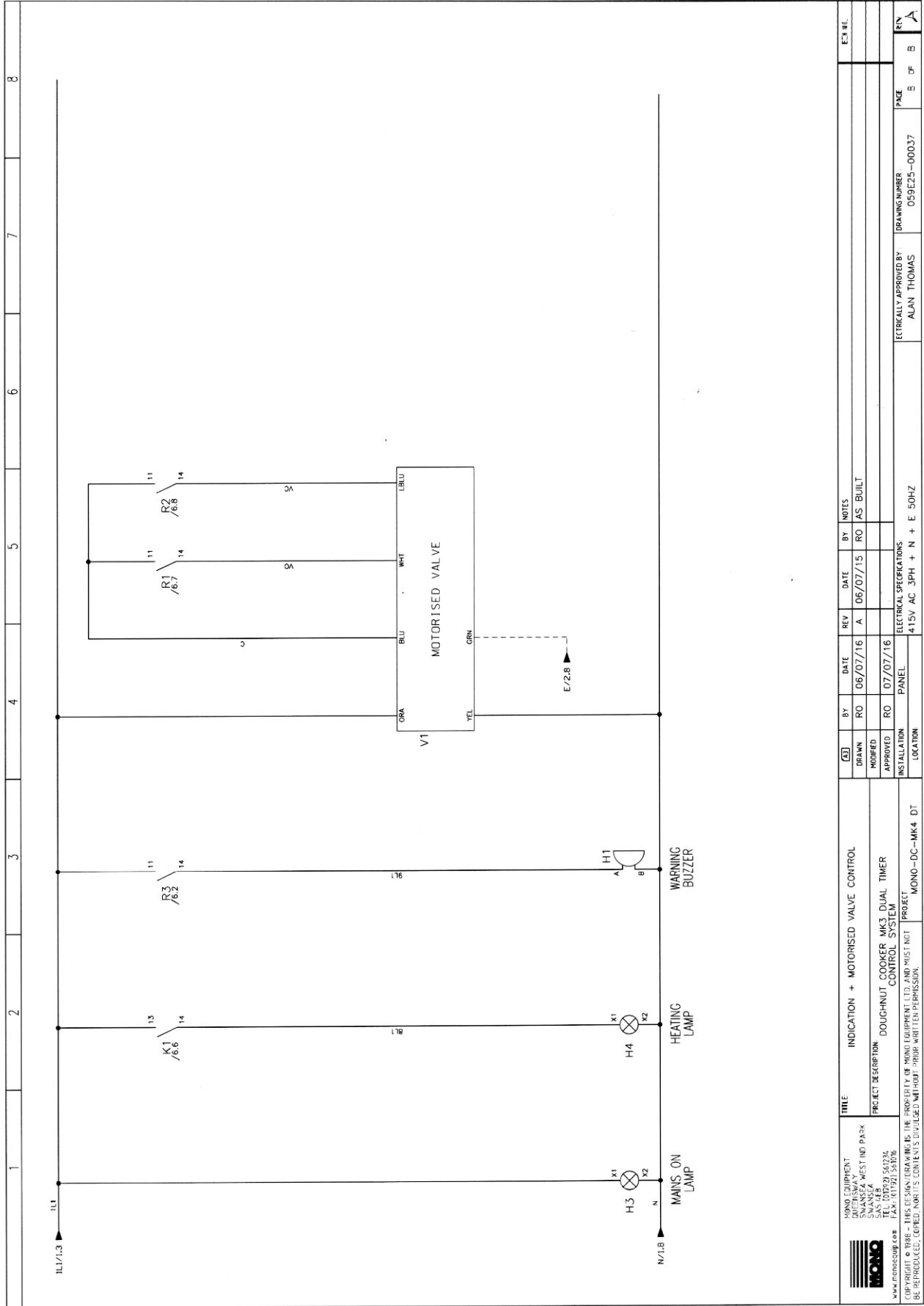

1

2

3

4

5

6

7

8

		<b>TITLE</b> INDICATION + MOTORISED VALVE CONTROL		<b>BY</b> RO		<b>DATE</b> 06/07/16		<b>REV</b> A		<b>DATE</b> 06/07/15		<b>BY</b> RO		<b>NOTES</b> AS BUILT		<b>ECN. NO.</b>	
MONO EQUIPMENT DUTERWAY SWANSEA WEST IND PARK SWANSEA SA6 4JF SALES TEL: 01792 310006 WWW.MONOGROUP.CO.UK		<b>PROJECT DESCRIPTION</b> DOUGHNUT COOKER MK3 DUAL TIMER CONTROL SYSTEM		<b>APPROVED</b> RO		<b>DATE</b> 07/07/16		<b>REVISION</b>		<b>DATE</b>		<b>BY</b>		<b>NOTES</b>		<b>ECN. NO.</b>	
COMPANY: MONO - THE DESIGN/INSTALL/TEST AND MAINTENANCE OF MONO EQUIPMENT LTD. AND MUST NOT BE REPRODUCED, COPIED, IMPRINTED OR TRANSMITTED IN ANY MANNER WITHOUT WRITTEN PERMISSION.		<b>PROJECT</b> MONO-DC-MK4 DT		<b>INSTALLATION</b>		<b>LOCATION</b>		<b>ELECTRICAL SPECIFICATIONS</b>		415V AC 3PH + N + E 50HZ		<b>ELECTRICALLY APPROVED BY</b> ALAN THOMAS		<b>DRAWING NUMBER</b> 059E25-00037		<b>PAGE</b> B OF B	
																<b>REV</b> A	





# 10. AZTEC FRYER FAULT CHECKS

- 1. DONUTS NOT CORRECT COLOUR
  - 2. NO MOVEMENT
  - 3. OIL NOT CIRCULATING (NO FILTERING)
  - 4. CARRIER COMES STRAIGHT BACK UP
  - 5. DONUTS NOT TURNING
  - 6. IF FRYER DOES NOT FUNCTION
  - 7. ALL OIL LEFT IN BOTTOM TANK.
- 

## 1. DONUTS NOT CORRECT COLOUR

- Contact your company head office. No adjustments should be attempted.
- If a private bakery, please contact our service team for any adjustments that may be required for your products.

## 2. NO MOVEMENT

- The carrier assembly will not move until oil is up to frying temperature.
- OR SEE SECTION 6

## 3. OIL NOT CIRCULATING (NO FILTERING)

- Is blue tube overhanging filter bag?
- Is white suction tube in bottom tank?



- Bottom tank filter bag not there (clogs suction tube) or very dirty (stops oil flow).
- Top tank not cleaned allowing build up around elements and clogs drain hole to tap.
- Mixing different frying oils causing reaction and sediment to form.
- (Looks like flour thrown in tank).
- **DO NOT USE SOLID FAT.**

## 4. CARRIER COMES STRAIGHT BACK UP

- Obstruction causing carrier to lift off support brackets.

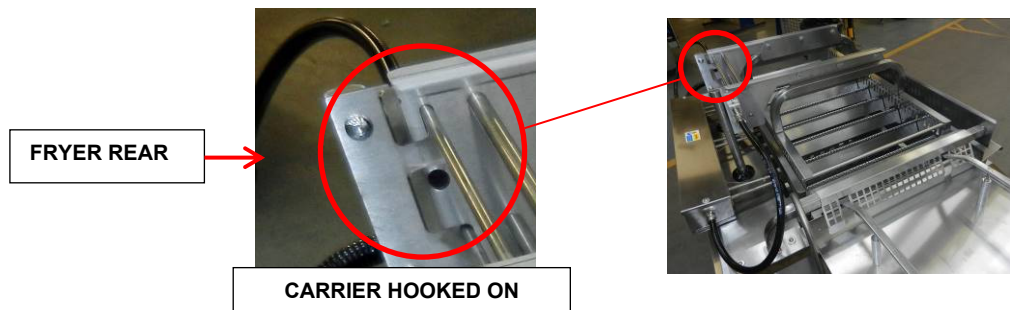

- Screws at bottom of carrier have been tightened. (Unlikely but should be loose to allow up/down movement).



## 5. DONUTS NOT TURNING

- Is oil at correct levels? (Check oil is to level shown on rear face of bottom tank).
- Has splitter unit been set at the correct gap for the type of donut?

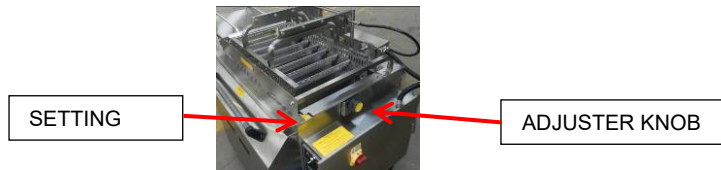

- Adjuster for donut size not working - Check if splitter unit slot is located on adjuster tab.

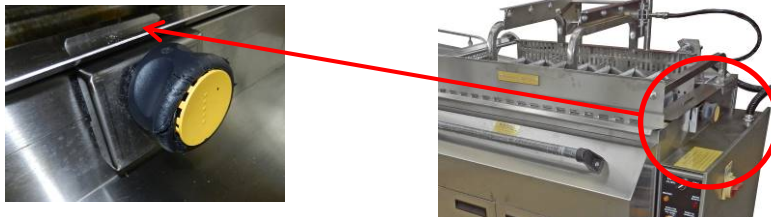

## 6. IF FRYER DOES NOT FUNCTION



1. Mains power connected? (Check socket on wall or store isolator)

2. Is yellow/red isolator switch on side at on position?

3. Is top switch on control panel to "ON" position?

4. Is mains light on panel "ON"? (IF NOT CHECK 1 AND 2 AGAIN)

5. Is elements heating light on panel "ON" after "PUSH CONFIRM OIL LEVEL" button is pressed?  
(GOES OUT WHEN OIL IS UP TO CORRECT TEMPERATURE)

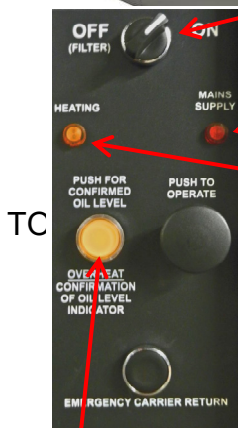

## LIGHT FLASHING AND BUZZING SOUND

1. Continuous buzzer and light flashing.

- This is normal and is asking for "push confirm oil level" button to be pressed.
- Only press if there is correct amount of oil in top and bottom tank.

2. On/off buzzer and light flashing.

- Bottom tank not pushed fully back in. Open doors and push tank in.

3. Continuous buzzer and light.

- Pump overload tripped. – **Call Engineer**

4. Continuous light only.

- Overheat tripped - **Call Engineer**

## **7. ALL OIL LEFT IN BOTTOM TANK.**

### **Cause:**

- Usually fryer has been turned off before filtering has finished.
- Something blocking tap. Lack of cleaning
- Faulty tap staying open after filtering. Call engineer

Try following to return oil to top tank.

### **1. Turn off power (*yellow and red knob on side of electrics box*)**

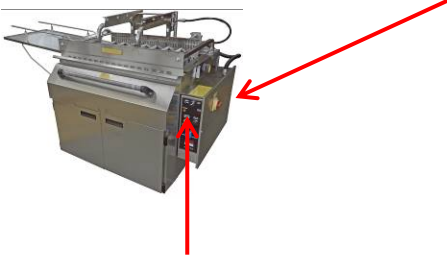

### **2. Turn top switch on control panel to “ON”**

### **3. Turn power on (*yellow and red knob on side of electrics box*)**

### **4. Buzzer should sound**

### **5. Press “PUSH TO CONFIRM OIL LEVEL” button**

(must go on to next step quickly or elements will overheat)

### **6. Turn top switch to “OFF FILTER”**

Tap should open and pump start. Wait and tap will close and top tank will fill.  
When pump stops, refill will be finished.

If this does not work, call engineer.



If a fault arises, please do not hesitate to contact the Customer Service Department, quoting the **machine serial number** on the silver information plate of the machine and on the front cover of this manual

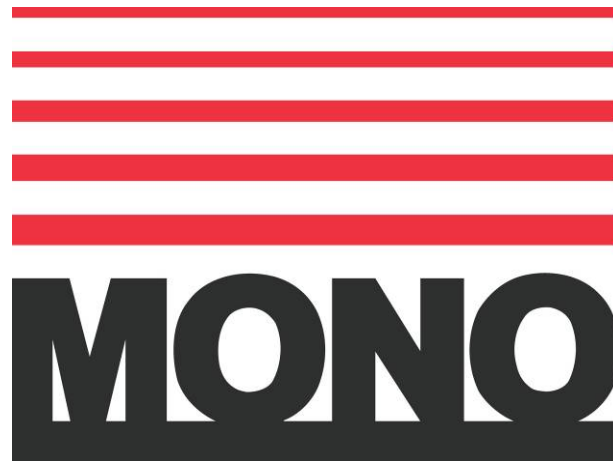

**MONO Equipment Limited**  
Queensway  
Swansea West Industrial Estate  
Swansea, SA5 4EB, UK

[www.monoequip.com](http://www.monoequip.com)

Email: [spares@monoequip.com](mailto:spares@monoequip.com)

Main: +44/0 1792 561234  
Spares: +44/0 1792 564039

### **Aztec Fryer Disposal**

Care should be taken when the machine comes to the end of its working life. All parts should be disposed of in the appropriate place, either by recycling or other means of disposal that complies with local regulations.

(In the United Kingdom, the Environmental Protection Act 1990 applies.)