

MonoEquip.com

Enter **Serial No.** here. _____

In the event of an enquiry please quote this serial number.



“OMEGA PLUS” INCLUDING WIRECUT VERSION DEPOSITOR (400, 450, 580)

OPERATING AND MAINTENANCE MANUAL

The use of templates and/or accessories not produced or supplied by MONO Equipment will invalidate the machine’s warranty

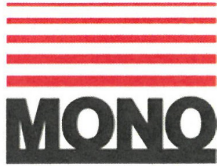

DECLARATION OF CONFORMITY

We hereby declare that this machine complies with the essential health and safety requirements of:

- The Machinery Directive 2006/42/EC
- The Low Voltage Directive 2014/35/EC
- The requirements of the Electromagnetic Compatibility Directive 2014/30/EU incorporating standards
 - o EN 55014-1:2017/A11:2020
 - o EN 55014-2:1997+A1:2001+A2:2008
- The General Safety of Machinery and food processing Standards applicable
- Materials and Articles intended to come into contact with food - Regulation (EC) No.1935/2004
- Good manufacturing practice for materials intended to come in to contact with food – Regulation (EC) No.2023/2006

Signed			
	Craig Petherbridge – Quality Manager		
Date			
Machine FG Code.		Machine Serial No.	

A technical construction file for this machine is retained at the following address:

MONO EQUIPMENT

Queensway,
Swansea West Industrial Park,
Swansea
SA5 4EB
UK

MONO EQUIPMENT is a business name of **AFE GROUP Ltd**
Registered in England No.3872673 VAT registration No.923428136

Registered Office:
Unit 35, Bryggen Road,
North Lynn Industrial Estate,
Kings Lynn
Norfolk
PE30 2HZ
UK

QD 001

Dated 22/07/2022

Failure to adhere to the cleaning and maintenance instructions detailed in this booklet could affect the warranty of this machine.



The use of templates and/or accessories not produced or supplied by MONO Equipment will invalidate the machine's warranty

SAFETY SYMBOLS

The following safety symbols are seen throughout this manual (available at www.monoequip.com). Before using your new equipment, read the instruction manual carefully and pay special attention to information marked with the following symbols



WARNING Indicates a hazardous situation which, if not avoided, could result in death or severe injury.



WARNING Indicates a hazardous situation which, if not avoided, could result in death or severe injury.



CAUTION Indicates a hazardous situation which, if not avoided, could result in minor or moderate injury.



ELECTRICAL SAFETY AND ADVICE REGARDING SUPPLEMENTARY ELECTRICAL PROTECTION

Commercial bakeries, kitchens and food service areas are environments where electrical appliances may be located close to liquids, or operate in and around damp conditions, or where restricted movement for installation and service is evident.

The installation and periodic inspection of the appliance should only be undertaken by a qualified, skilled and competent electrician, and connected to the correct supply suitable for the load as stipulated by the appliance data label.

The electrical installation and connections should meet the necessary requirements of the local electrical wiring regulations and any electrical safety guidelines.

We Recommend:

- Supplementary electrical protection with the use of a residual current device (RCD)
- Fixed wiring appliances incorporate a locally situated switch disconnecter to connect to, which is easily accessible for switching off and safe isolation purposes. The switch disconnecter must meet the specification requirements of IEC 60947.

Your attention is drawn to:

BS 7671:2018 – Guidance Note 8 – 8.13 : Other locations of increased risk

It is recognised that there may be locations of increased risk of electrical shock other than those specifically addressed in Part 7 of BS 7671. Examples of such locations could include laundries where there are washing and drying machines in close proximity, and water is present, and commercial kitchens with stainless steel units, where once again, water is present. Where, because of the perception of additional risks being likely, the installation designer decides that an installation or location warrants further protective measures, the options available includes:

- Automatic Disconnection of Supply (ADS) by means of a residual current device having a residual operating current not exceeding 30 mA;
- Supplementary protective equipotential bonding; and
- Reduction of maximum fault clearance time.

The provision of RCDs and supplementary bonding must be specified by the host organisation's appointed installation designer or electrical contractor and installed by a suitably qualified and competent electrician so as to comply with Regulations 419.2 and 544.2.



The supply to this machine must be protected by a **30mA RCD**

CONTENTS

1.0	-	INTRODUCTION	Page 7
2.0	-	DIMENSIONS	Page 8
3.0	-	SPECIFICATIONS	Page 9
4.0	-	SAFETY	Page 10
5.0	-	INSTALLATION	Page 12
6.0	-	ISOLATION	Page 12
7.0	-	CLEANING INSTRUCTIONS	Page 13
8.0	-	OPERATING CONDITIONS	Page 17
9.0	-	PREPARING FOR OPERATION	Page 18
		9A – FITTING THE HOPPER	Page 19
		9B – FITTING A TEMPLATE	Page 20
10.0	-	OPERATING INSTRUCTIONS	Page 25
		1 – SELECT PRODUCT TYPE	Page 28
		2 – SELECT SAVED NAME OF PRODUCT TYPE	Page 29
		3 – CONFIRM SETUP	Page 30
		4 – OPERATOR SCREEN	Page 31
		5 – EDIT SCREEN	Page 32
		5A – TRAY SETUP	Page 35
		6 – COPY	Page 36
		7 – DELETE	Page 37
		8 – PASSWORDS	Page 38
		9 – ENGINEERING SETTINGS	Page 39
		10 – FAULT INFORMATION SCREENS	Page 45
		11 – DEVICE MANAGEMENT	Page 47
11.0	-	MAINTENANCE	Page 50
		CHECK AND MAINTENANCE SCHEDULE	Page 51
12.0	-	SPARES AND SERVICE	Page 52
13.0	-	ELECTRICAL INFORMATION	Page 59
		OMEGA TLCC/LMC TO M251 CONVERSION KITS	Page 75
		TLCC to M251 Conversion Procedure	Page 76
		LMC20 to M251 Conversion Procedure	Page 87
		Battery Replacement Procedure (M251 Motion Controller)	Page 95

1.0 INTRODUCTION

Omega
PLUS +
WIRECUT

- The innovative “five axis deposit” design of MONO’s “**Omega PLUS**” and “**Omega PLUS with wirecut**” depositor allows it to recreate most of the hand movements of the Master confectioner. This makes the “**Omega PLUS**” capable of exceptional accuracy of product weight, size and shape.
- Maintenance is kept to a minimum and the smooth body design makes daily cleaning quick and easy.
- Easy to use computer software gives access to 550 recipe programs, which are stored in the memory and easily recalled for use or modification. Recipes and settings can also be backed-up to, and restored from, a USB memory stick (pen drive). The Omega machine can also be updated with new software on a USB memory stick. Control is via a colour touch screen with graphically represented products, already installed, that can be created or edited to the required product.
- It is available with soft and hard dough hoppers. There is also a large selection of templates and nozzles as well as various shape biscuit dies to use with the wirecut version.

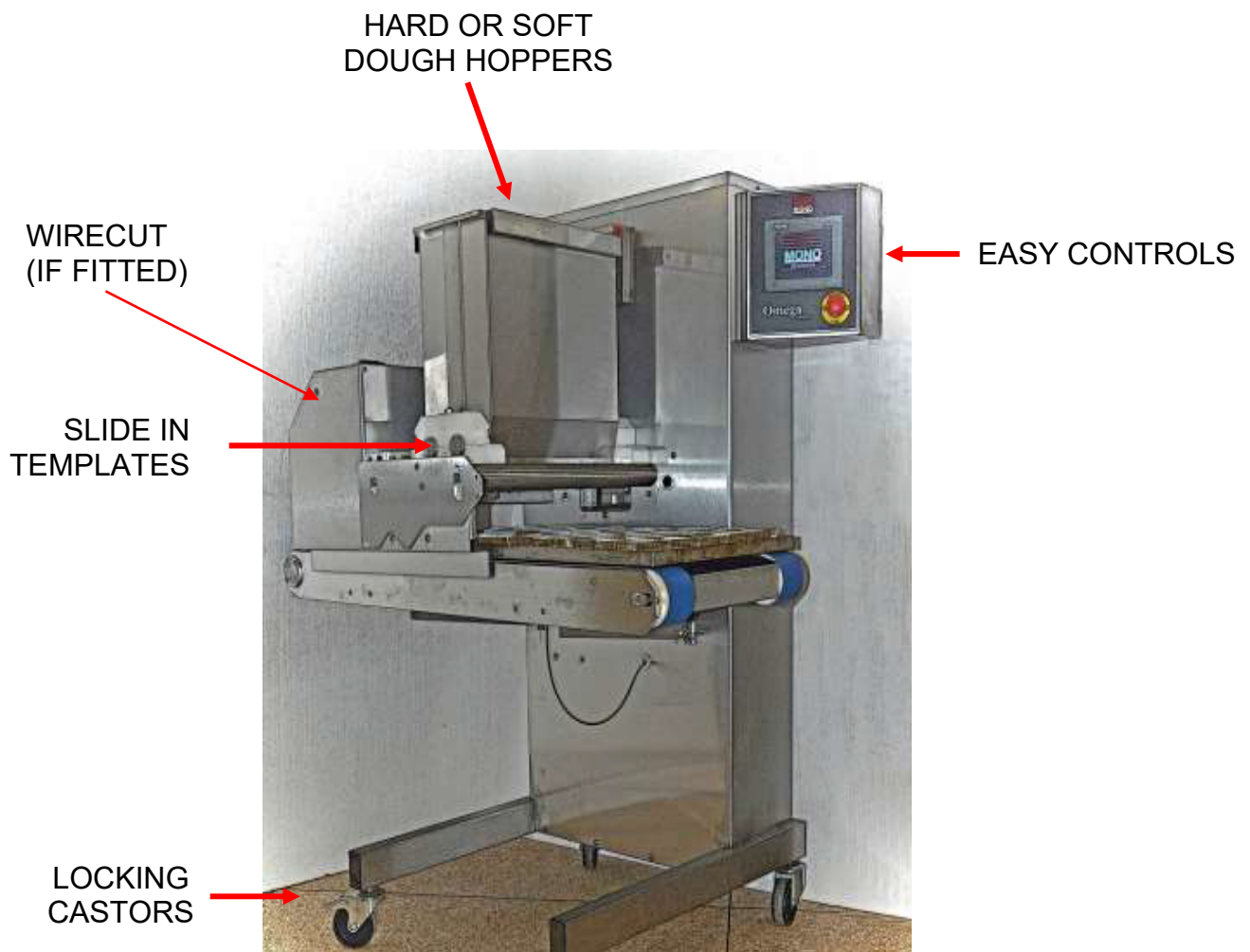

As it is our policy to improve our machines continuously, we reserve the right to change specifications without prior notice

2.0 DIMENSIONS



MODELS ARE AVAILABLE WITH OR WITHOUT WIRECUT OPTION

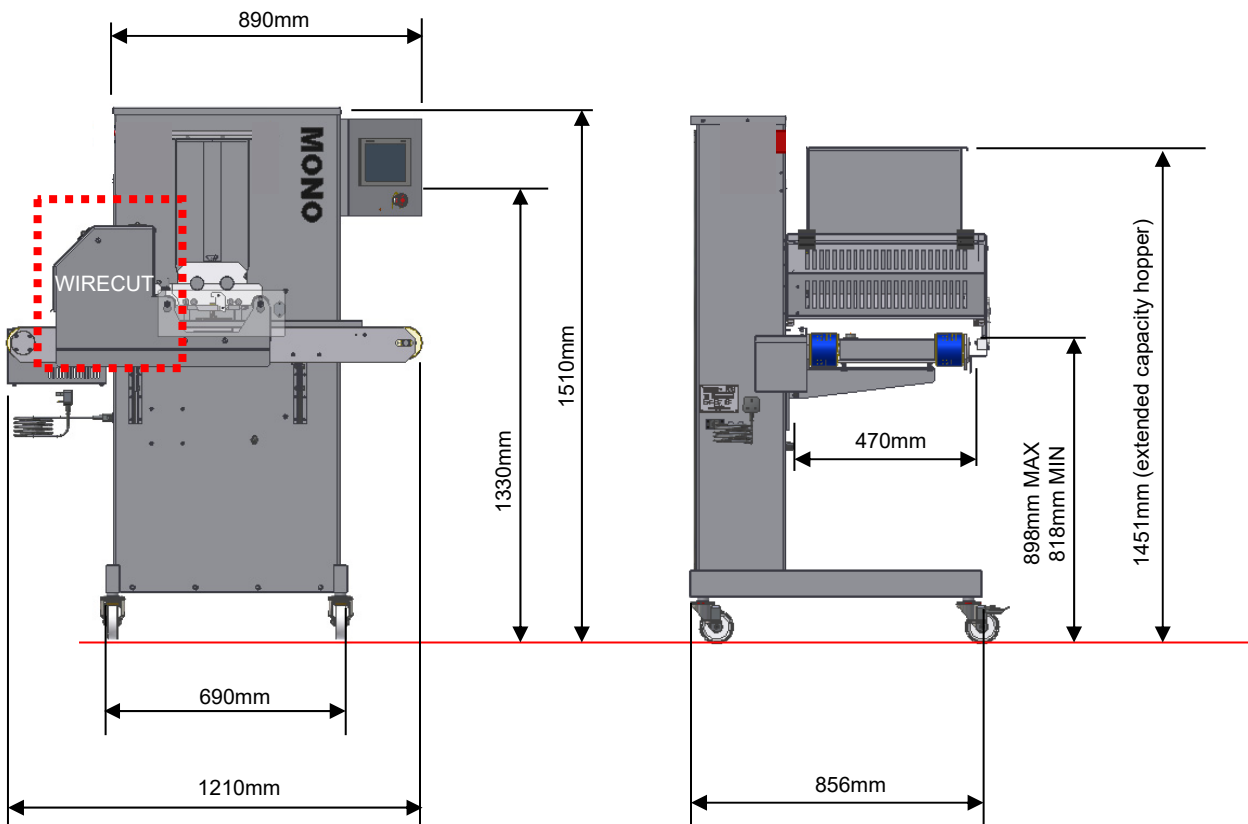

WIRECUT VERSION



OMEGA PLUS

3.0 SPECIFICATIONS

	<u>SOFT DOUGH</u>			<u>HARD DOUGH</u>		
MODEL (Nom. hopper width (mm))	400	450	580	400	450	580
Approx. Weight (with hopper fitted) (kg) : (Inc Wirecut)	180 197	185 204	200	196 210	212 224	235
Standard hopper Approx. Capacity (litre) :	20	22.5		21	24	
Extended hopper Approx. Capacity (litre) :	36	41	53	31	35	45

Power: Single phase, 13A max load. Suitable for 200v, 220v, 230v, and 240v, 50-60 Hz supply.
MAX RATING 2.5kW single phase fused at 13A



The supply to this machine must be protected by a **30mA RCD**

- Cycles per minute = Up to 35
- Min distance between trays = 50mm
- Max vertical travel = 80mm
- Max program storage = 650
- Number of languages = 18 (additional in future)
- Noise level = Less than 85dB
- Electronics = All microprocessor controlled

NOTE:

The minimum deposit that can be made depends on several factors - recipe, mixing method, template size, nozzle size and deposit speed.

As a guide the following is the minimum that should be attempted:

- Macaroons 6g.
- Meringues 3g.
- Choux Paste 5g.
- Viennese 4g.
- Sponge Drops 4g.

However, consult **Mono Equipment** if intended product falls outside the above general machine specification to determine the exact capabilities of the “Omega” with any specific product.

As it is our policy to improve our machines continuously, we reserve the right to change specifications without prior notice

- 1 **Never use a machine in a faulty condition** and always report any damage.
- 2 **Only trained engineers** may remove parts that need a tool to remove them.
- 3  Always ensure hands are dry before touching any electrical appliance (including cable, switch and plug). **NEVER move machinery by pulling on the power cords or cables.**
- 4 **Ensure that the floor area around the OMEGA is clean to avoid slipping** – especially if carrying heavy hopper and template components to and from the machine.

5 **All operatives must be fully trained.**

Use of the machine can prove dangerous if:

- the machine is operated by **untrained or unskilled staff**
- the machine is not used for its **intended purpose**
- the machine is **not operated correctly**

All safety devices applied to the machine during manufacture and the operating instructions in this manual are required to operate this machine safely. The owner and the operator are responsible for operating this machine safely.

- 6 People undergoing training on the machine must be under **direct supervision**.

7 **Do not operate the machine with any panels or guards removed.**

They are there to protect you.

8 **No loose clothing or jewellery** should be worn while operating the machine.

They could cause damage to the machine and person.

- 9 **Switch off power** at the mains isolator when machine is not in use and **before carrying out any cleaning or maintenance.**

10 The bakery manager or the bakery supervisor should carry out **daily safety checks** on the machine.



11 Do not operate machine without a hopper **template** and the **guard fitted correctly**.

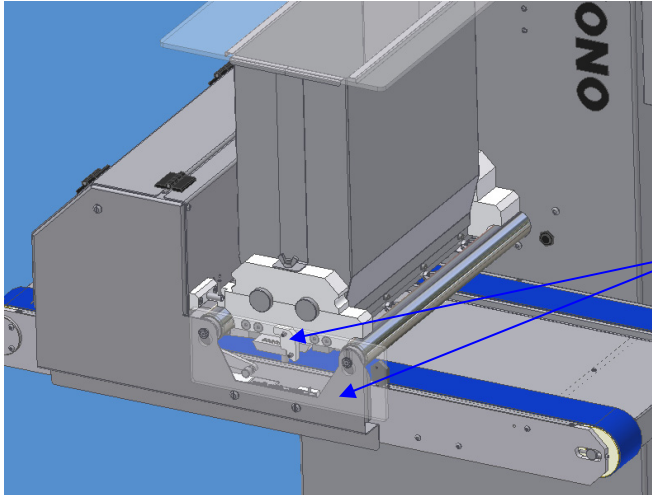

**(11) HOPPER TEMPLATE AND
GUARD FITTED**

NOTE
Guard can be plastic or metal depending
on the machine model

12 Due to the essential requirement for handling heavy components during cleaning, it is commended that **protective footwear** be worn when carrying out such procedures.



**ALL CLEANING AND MAINTENANCE OPERATIONS
MUST BE MADE WITH THE MACHINE
DISCONNECTED FROM THE POWER SUPPLY.**

5.0 INSTALLATION

1. Ensure that the depositor is connected to correct electric supply, as specified on the serial number plate on the side of the machine.



The supply to this machine must be protected by a **30mA RCD**

2. Ensure that the correct fuse rating is fitted in the electrical supply
3. Position the machine in the correct position for working and lock the two locking wheels to stop movement.

6.0 ISOLATION



IN AN EMERGENCY, SWITCH OFF AT THE ELECTRICAL MAINS WALL ISOLATOR, OR PUSH THE EMERGENCY STOP BUTTON.

To release the emergency stop button, turn clockwise.



STOP BUTTON

7.0 CLEANING INSTRUCTIONS

Omega
PLUS

NOTE:

- Cleaning must be carried out by fully trained personnel only.
- Isolate machine from mains supply before carrying out any cleaning.
- Do not steam clean or use a jet of water.



-Do not use any form of caustic detergent or abrasive cleaners. -

All the outer surfaces of the machine should be wiped over daily with warm soapy water.

HARD AND SOFT DOUGH HOPPERS BETWEEN PRODUCT MIX CHANGES

The feed hopper, pump assembly, template, nozzles etc. should be removed from the machine and dismantled for thorough cleaning between product mix changes.

1. Open hopper and remove excess mixture remaining.
2. Lift off front safety cover.

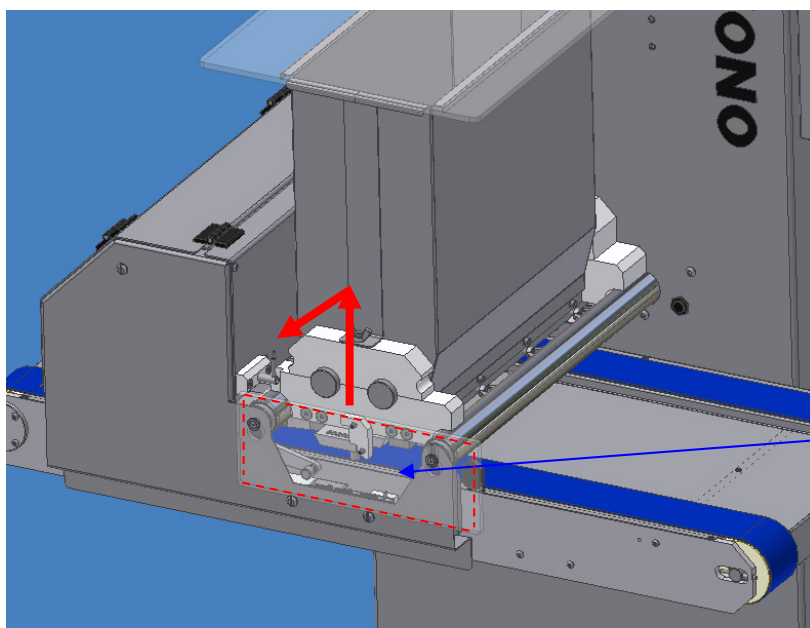

SAFETY COVER

NOTE
Guard can be plastic or metal depending
on the machine model

3. Slacken template clamp strip nuts or thumbscrews (depending on type of hopper). Remove fitted template from pump assembly by sliding out to avoid subsequent damage.

NOTE.

Thumbscrews only need to be released slightly to allow the template to slide away from the pump assembly. If loosened too much, the template will have to be supported.

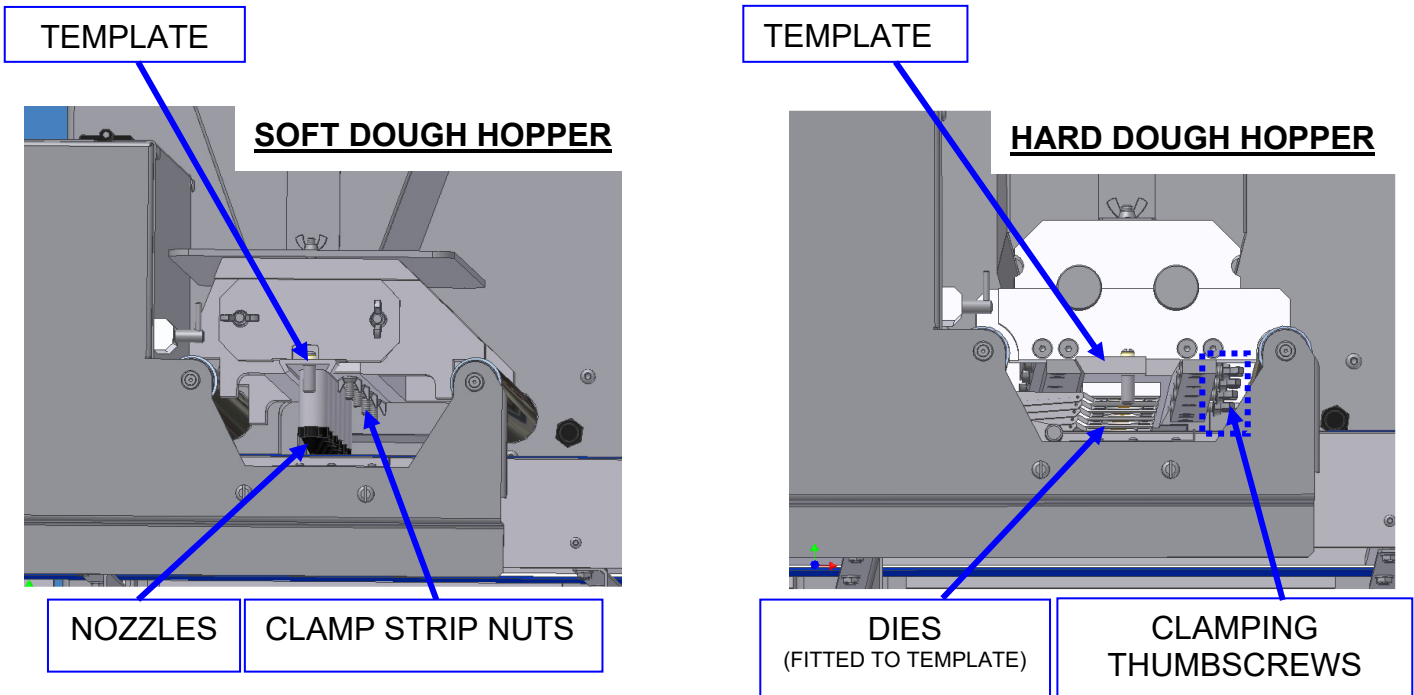

- 4 To reduce weight and bulk, separate and remove empty feed hopper from pump assembly, whilst still on the machine, by unscrewing the wing nuts.

To gain access to the inner wing nut, slide the complete hopper away from the machine body slightly (keep on support bars) - this will also disengage the pump assembly from the drive shaft.

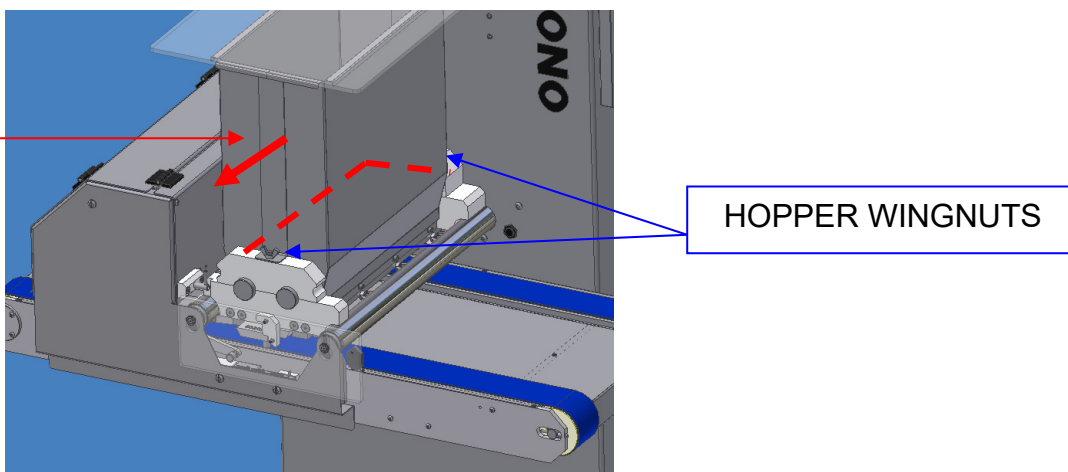

Ensure that the nuts are placed where they will not be lost.

SOFT DOUGH HOPPER



CAUTION:

The feed hopper and pump assembly exceeds 25kg and will need to be lifted off by two people, or dismantled into smaller components while still on the machine.

Take care to avoid damage to the sealing surface of the feed hopper during removal, cleaning, assembly and storage.

1. After removing the feed hopper, check condition of feed hopper seal.
2. Unscrew the end cap retaining nuts from the accessible side of the pump assembly.
[Ensure that the nuts are placed where they will not be lost.]

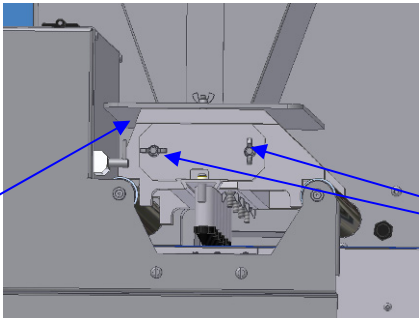

FEED HOPPER
SEALING SURFACE

ENDCAP NUTS

3. Withdraw the end-cap with the pump gears.

Ensure that the 'O' sealing ring on the inside of the end cap is not damaged during cleaning.

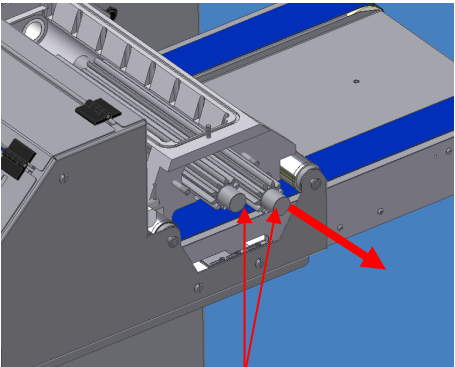

PUMP GEARS
REMOVE WITH END CAP
(NOT SHOWN)

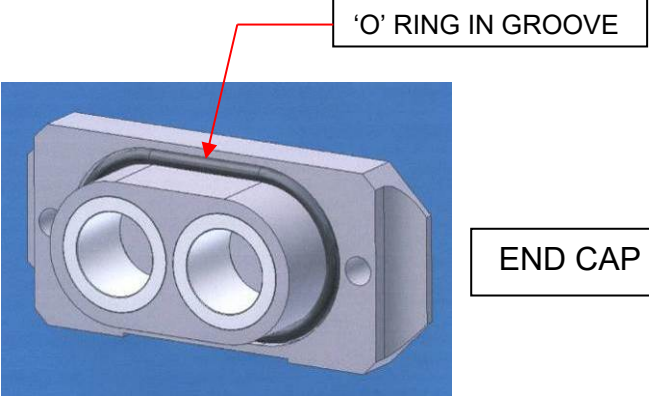

'O' RING IN GROOVE

END CAP

4. Remove remainder of pump assembly from the machine and remove remaining end-cap to fully dismantle pump assembly components for cleaning.

HARD DOUGH HOPPER



CAUTION:
The feed hopper and pump assembly exceeds 25kg and will need to be lifted off by two people, or dismantled into smaller components while still on the machine.

To reduce weight and bulk, separate and remove empty feed hopper from pump assembly, whilst still on the machine, by unscrewing the wing nuts.
(Ensure that the nuts are placed where they will not be lost.)
 The pump assembly will now be lighter and more easily removed.

1. Lift off both upper plastic end-caps.
2. Remove both gears from the assembly, one at a time, by lifting vertically.
3. Remove remainder of pump assembly from the machine for cleaning.

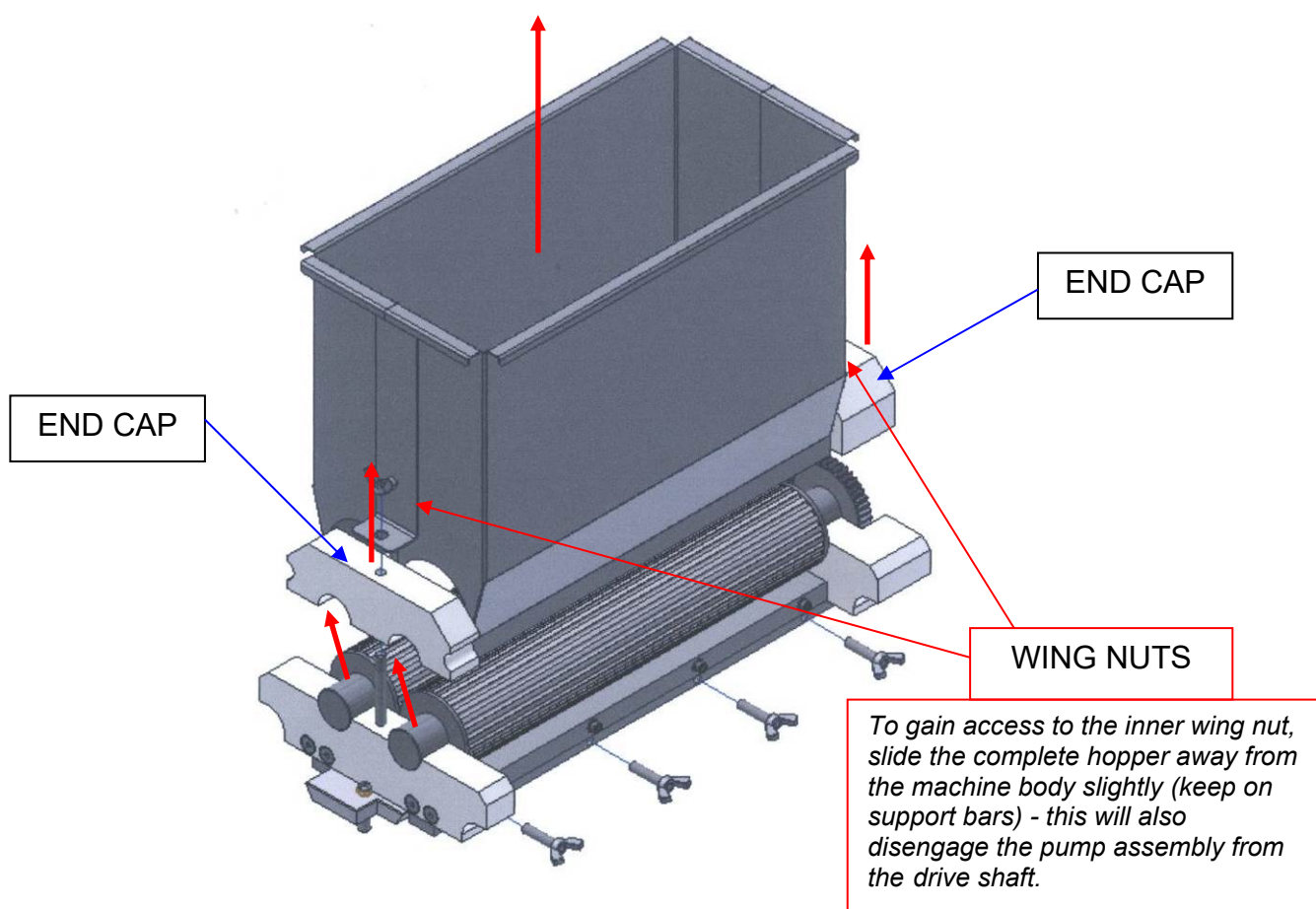

NOTE:

Use only warm soapy water to clean these parts. They should be rinsed and thoroughly dried before re-assembly.
The greatest care must be taken not to drop any parts.



Do not leave any components in the hopper.



8.0 OPERATING CONDITIONS

To obtain the best product results and consistent operation,

- ✓ Make sure the depositor is used on a **level floor**.
- ✓ Ensure **flat trays** of consistent length, width, material and edge dimensions are used.
- ✓ Ensure **undamaged nozzles and templates** are used.
- ✓ Keep the machine **clean**.



9.0 PREPARING FOR OPERATION

Omega

The use of templates and/or accessories not produced or supplied by MONO Equipment will invalidate the machine's warranty

- 1 Select template and nozzles (and finger frame, if wirecut is to be used) and fit as section 9a & 9b (following pages). Fill hopper with mix and close hopper cover.

It is recommended that when heavy mixes are used, the inside of the hopper should be coated with vegetable oil; for lighter mixes such as meringue, dampen with water. The oil or water will help the mix to settle down the hopper walls and prevent air being sucked in.

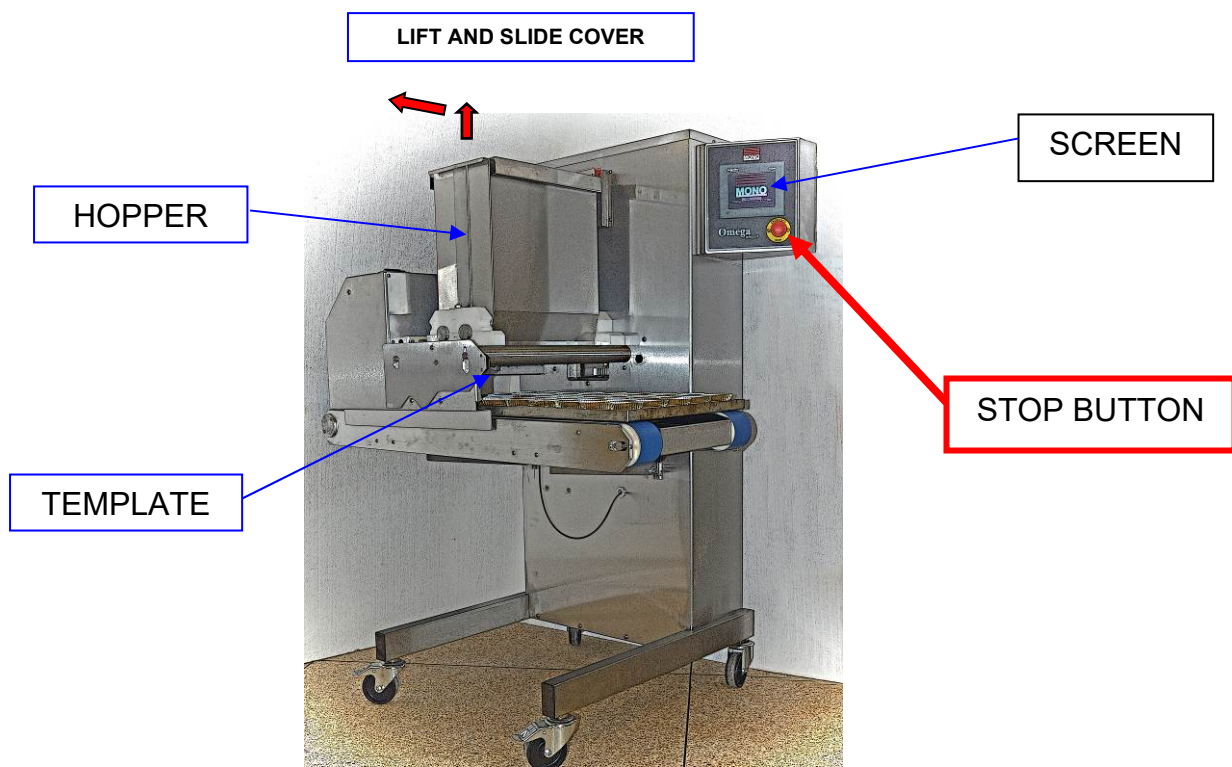

- 2 Connect power cable to electrical supply.
Make sure stop button is in released position (turn clockwise if required).
- 3 Select an existing program or create a new program through the on-screen menus.
(see section 10 operation)
- 4 The machine is now ready for operation.

9a FITTING THE HOPPER



CAUTION SHOULD BE TAKEN WHEN FITTING THE HOPPER AND PUMP ASSEMBLY, AS WEIGHT EXCEEDS 25kgs ON SOME MODELS. It will need to be lifted on by two people, or dismantled into smaller components before fitting on the machine. MAKE SURE THE FLOOR AREA AROUND THE MACHINE IS CLEAN



To reduce weight and bulk, fit the complete hopper assembly in two stages - first the pump assembly onto the support bars, then the feed hopper body onto the pump assembly.

- 1 By hand, align pump assembly drive gear roller with drive shaft on machine.
- 2 Fit hopper to pump assembly and secure with wing nuts.
- 3 Slide hopper on support bars until fully up against machine.

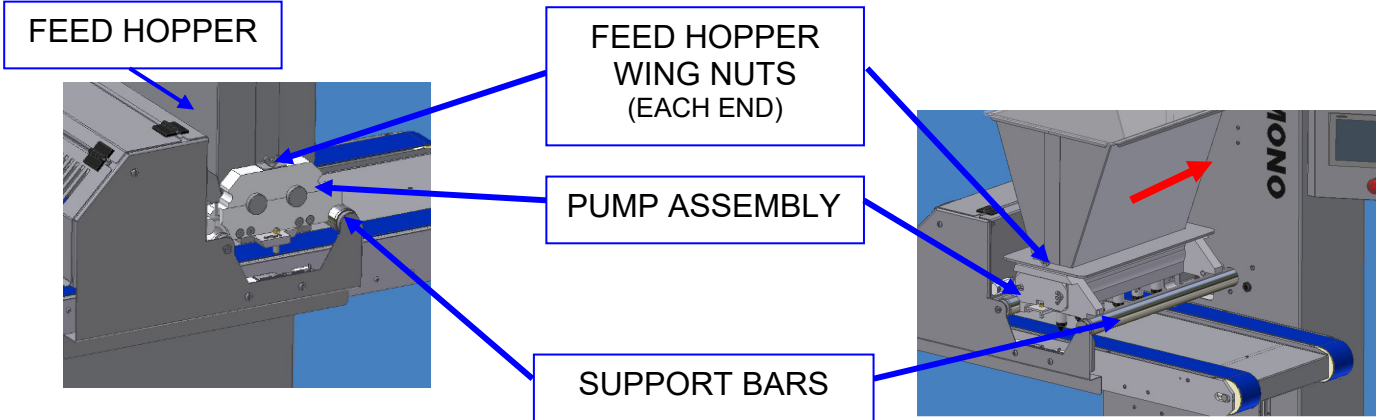

HARD DOUGH

SOFT DOUGH

- 4 After the hopper is fitted, the safety guard **MUST BE** replaced with the reflector facing towards the machine body.

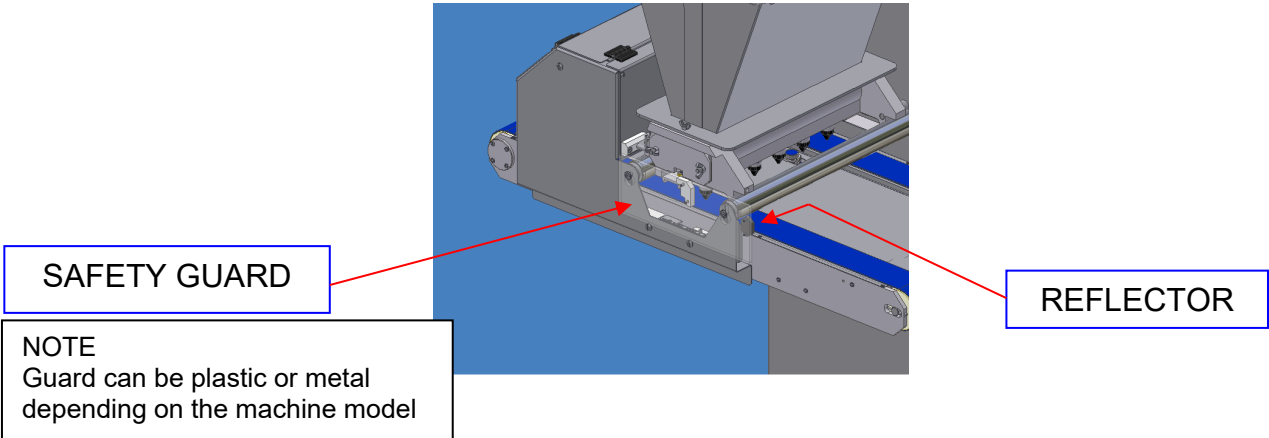

DO NOT OPERATE MACHINE WITHOUT TEMPLATE FITTED

9b FITTING A TEMPLATE

- **Soft dough**

Non-rotary templates can be fitted with nozzles. This requires screwing the nozzles into the threaded holes provided.

Rotary templates can have plastic nozzles screwed into nozzle holders (straight or offset).

OR

Metal nozzles secured in place by a separate nut.

- 1 Select template and nozzles required.
(Nozzles are not required for sheeting, staggered or stub templates)
- 2 Attach nozzles to template body:

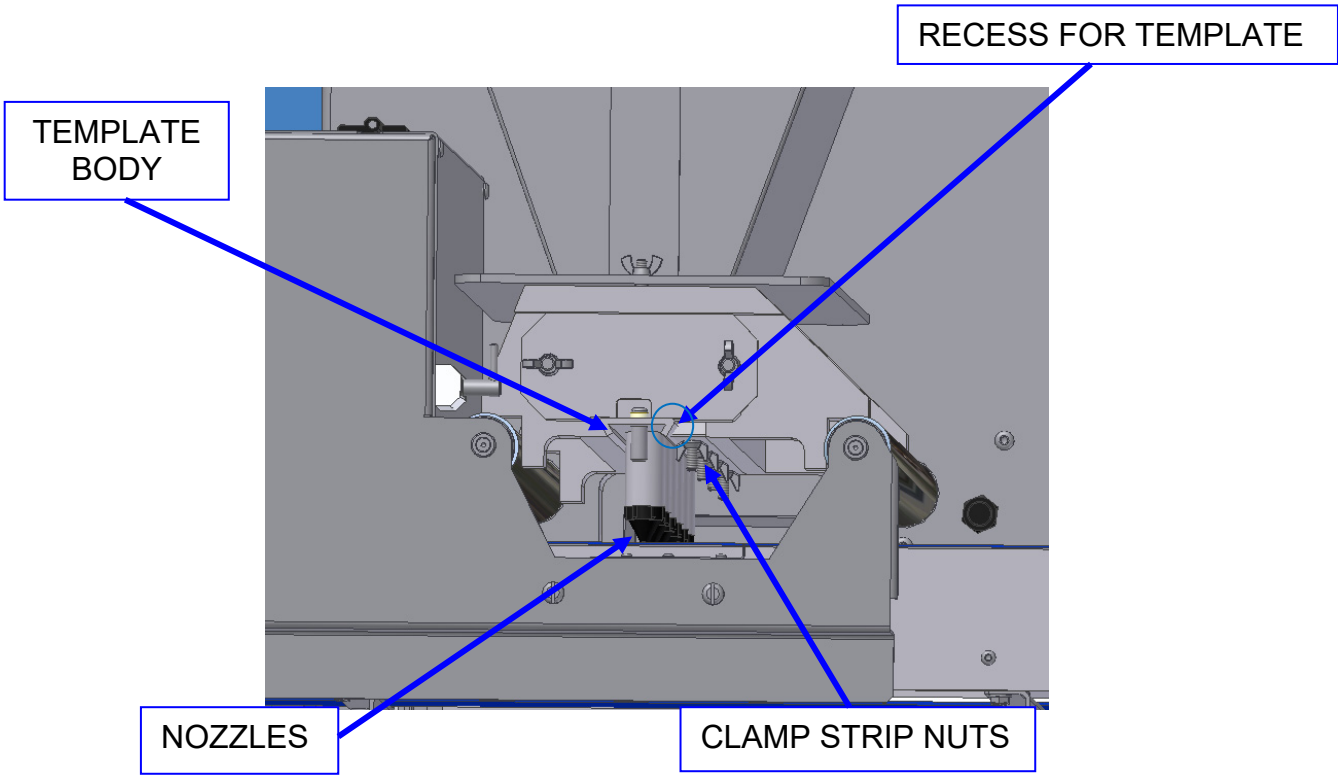

- 3 Slide the template into the matching recess at the base of the pump assembly until the stop is in position.
- 4 Tighten the nuts on the clamp strip (on underside of pump assembly) to secure template.

NOTE. *If the nuts are not securely tightened, leakage of mix will occur, affecting deposit weights.*



DO NOT OPERATE MACHINE WITHOUT TEMPLATE FITTED

BEFORE USING STRAIGHT & OFFSET NOZZLE HOLDERS **“O” RINGS MUST BE FITTED**

Nozzle holders provide the means of attaching standard plastic nozzles to the soft dough rotary templates and the sealing rings need to be fitted before using and may need replacing occasionally to ensure correct operation.

“O” RING PART NUMBER = A900-12-010 (SUPPLIED IN BAGS OF 20)

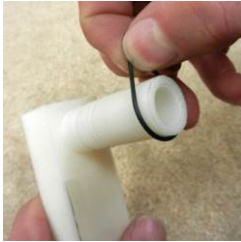

LOOP FIRST RING OVER END



SLIDE RING DOWN TO GROOVE



FIRST RING IN CORRECT POSITION

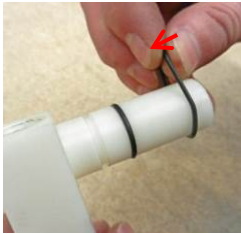

LOOP SECOND RING OVER END



SLIDE RING DOWN TO SECOND GROOVE,
PASSING OVER FIRST RING



SECOND RING IN CORRECT POSITION

Hard dough

Non-rotary templates that can be fitted with nozzles require them to be secured in place with a separate nut. *Nozzles are not required for sheeting or wirecut templates.*

Rotary templates require nozzles to be secured in place with a separate nut.

- 1 Select wirecut template or template and nozzles required.
- 2 Attach nozzles (if required) to template body using special nut:
- 3 Slide template into position and hand-tighten thumbscrews.

NOTE.

Thumbscrews only need to be released slightly to allow the template to slide away from the pump assembly. If loosened too much, the template will have to be supported while the screws are tightened.

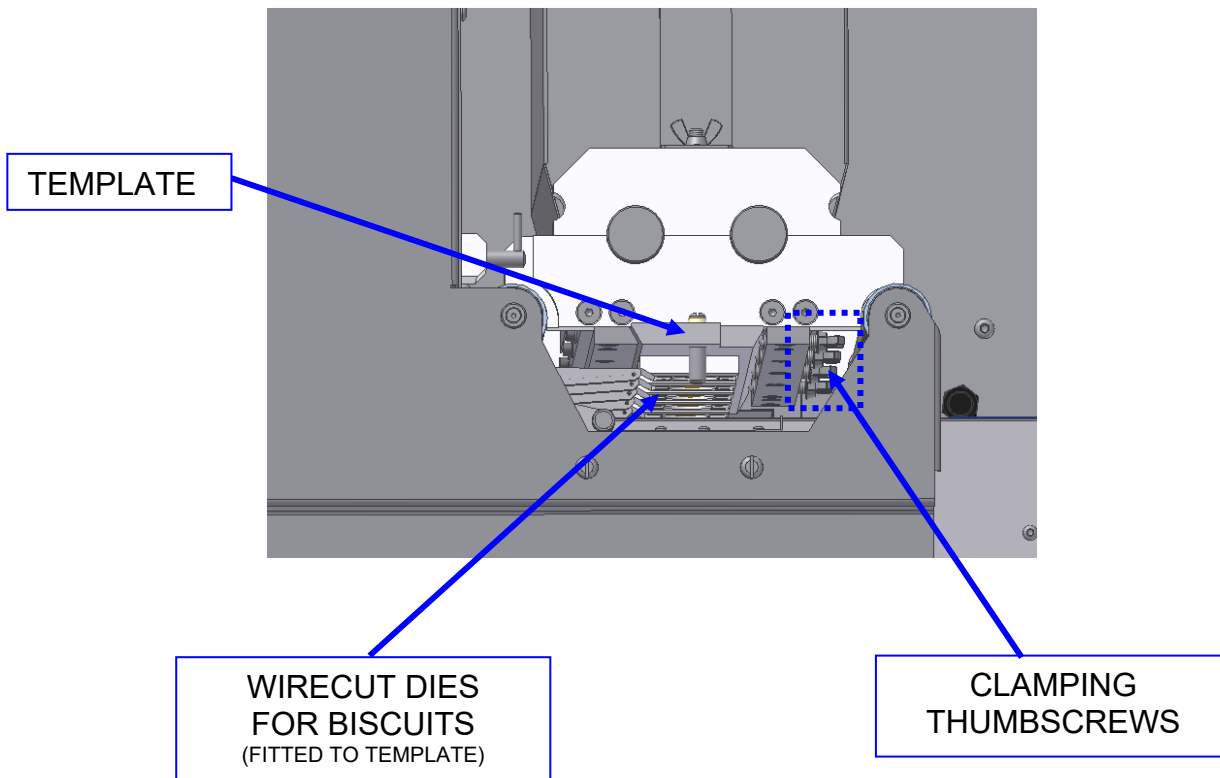

DO NOT OPERATE MACHINE WITHOUT TEMPLATE FITTED

IF WIRECUT IS FITTED

FITTING WIRECUT FINGERS

1. Select wirecut fingers that suit the chosen template to be used.i.e. the correct number to match the number of dies across template.
2. Remove drop arm pins and insert finger frame into arms. Ensure that the follower arm roller is positioned on the cam track.

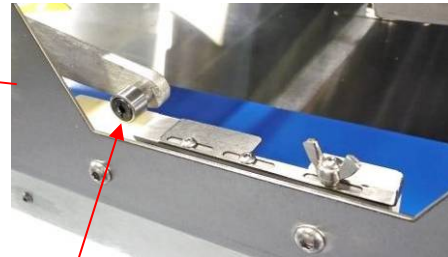
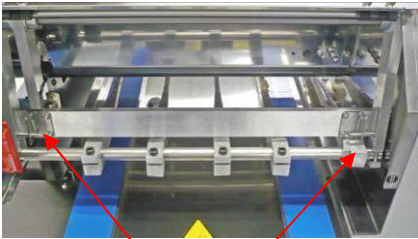

FOLLOWER ARM ROLLER

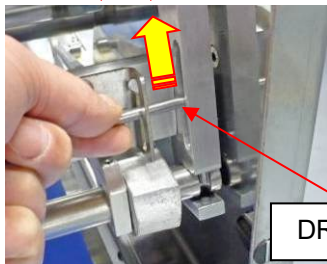

DROP ARM PINS

3. Replace drop arm pins.
4. Disconnect motor release knob and push fingers forward in order to line up the wire with the dies.



MOTOR RELEASE KNOB

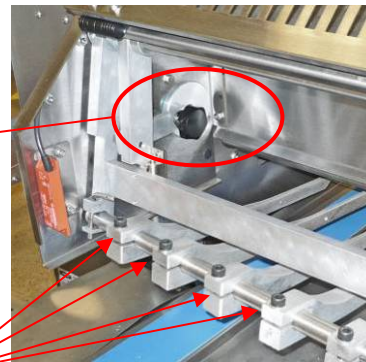

FINGER ADJUSTING BOLTS

5. Adjust individual finger bolts to raise the wire to touch the bottom surface of the dies used in the template.

OR

Adjust the spring loaded screw to raise or lower all fingers at the same time.



SPRING LOADED ADJUSTMENT SCREW

IF WIRECUT FITTED

REPLACING BROKEN WIRE

MAKE SURE THAT ALL PIECES OF WIRE HAVE BEEN FOUND BEFORE OPERATING MACHINE AFTER A WIRE REPLACEMENT.

1. Remove wirecut fingers from the machine.
2. Remove all parts of broken wire
3. Feed new wire round fixing screw, between washers and tighten screw.
4. Feed the wire through the eyehole in the end of each finger.
5. Feed new wire round other fixing screw, between washers. Pull wire tight and tighten screw. (wire should be like a guitar string).
6. Replace the fingers back in the machine and check set up and operation.

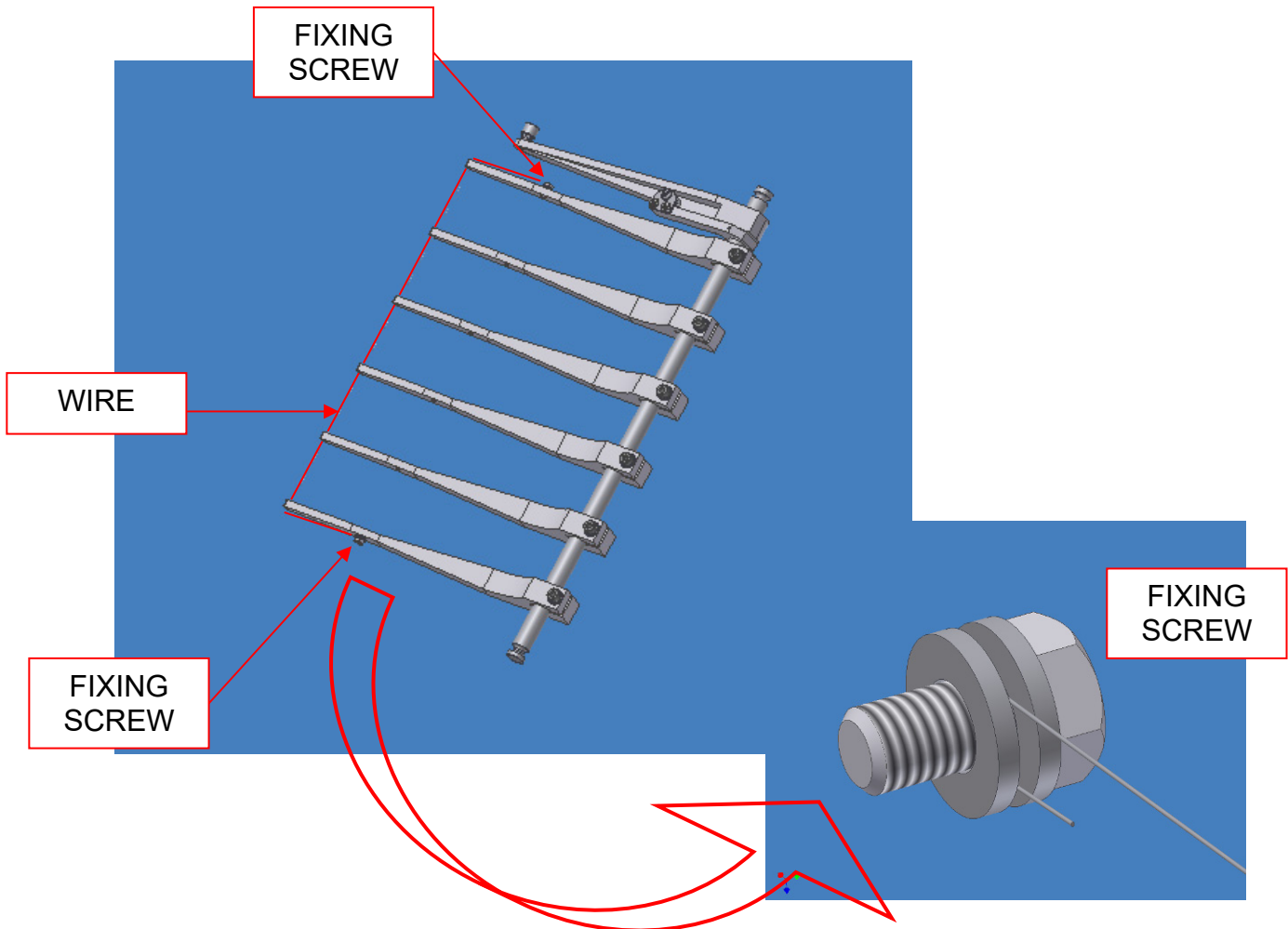

10.0 'OMEGA PLUS' OPERATION



Software Information



OMEGA TOUCH

HMI V1.0 TLCC V0.000

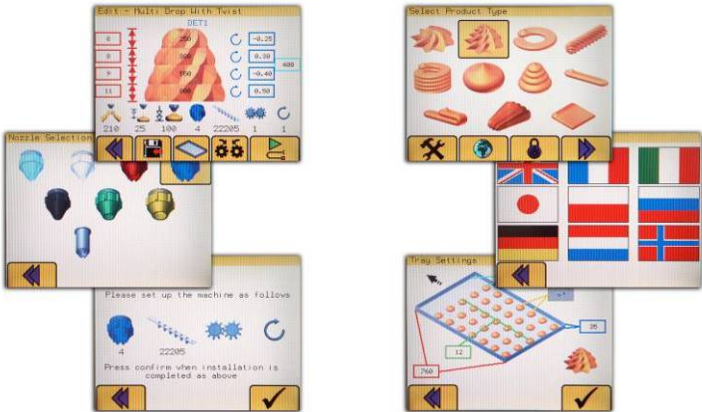

ALL OPERATIONS ARE ACTIVATED BY TOUCHING AREAS ON THE SCREEN WITH A FINGER. DO NOT USE EXCESSIVE FORCE OR HARD OBJECTS AS THIS WILL INVALIDATE MACHINE WARRANTY.

OPERATING KEY

FOR FOLLOWING INSTRUCTIONS

BLUE = OPERATION FOLLOW BLUE ARROWS AND BOXES TO OPERATE THE DEPOSITOR WITH ALREADY SAVED PROGRAMS

RED = CHANGE SETTINGS FOLLOW RED ARROWS AND BOXES TO CHANGE SETTINGS AND CREATE NEW PROGRAMS

 **= KEYBOARD ENTRY REQUIRED** WHEN KEYBOARD APPEARS, A CODE MUST BE ENTERED BY TOUCHING THE NUMBERS IN THE CORRECT ORDER

IF A GREY BOX IS SHOWN IN THE BUTTON DESCRIPTION
 e.g. 7 GO TO THE CORRESPONDING PAGE FURTHER ON IN THE INSTRUCTIONS.
 (MARKED IN TOP RIGHT HAND CORNER OF EACH PAGE)

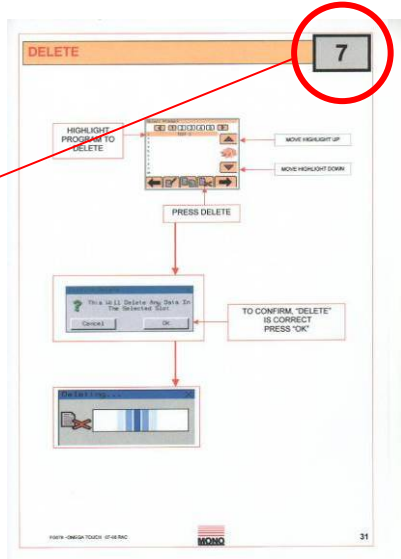
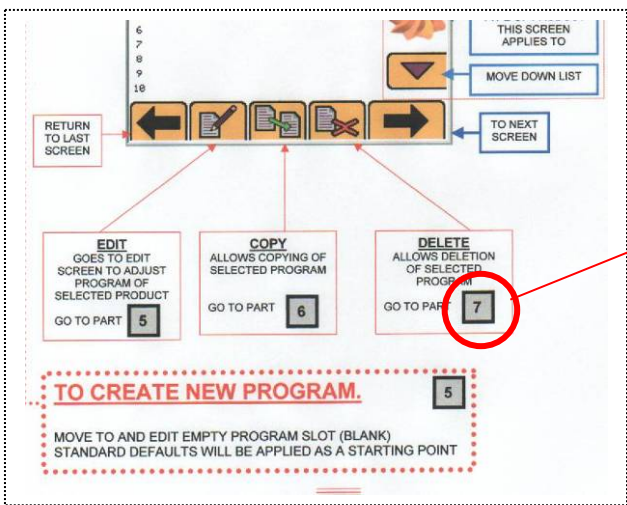

START

To turn on the machine, plug in the power cord and turn on the power supply.



This screen will be seen. Wait for the following screen to be displayed.



When this screen appears the machine is ready for operation. Touch the screen anywhere to start setup and operation.

SELECT PRODUCT TYPE

SELECT PRODUCT TO DEPOSIT OR TO CREATE A NEW PROGRAM

1

ALL OPERATIONS ARE ACTIVATED BY TOUCHING AREAS ON THE SCREEN WITH A FINGER.
DO NOT USE EXCESSIVE FORCE OR HARD OBJECTS AS THIS WILL INVALIDATE MACHINE WARRANTY.

**TOUCH THE SCREEN FOR THE TYPE OF PRODUCT REQUIRED
THEN → TO MOVE TO THE NEXT SCREEN**

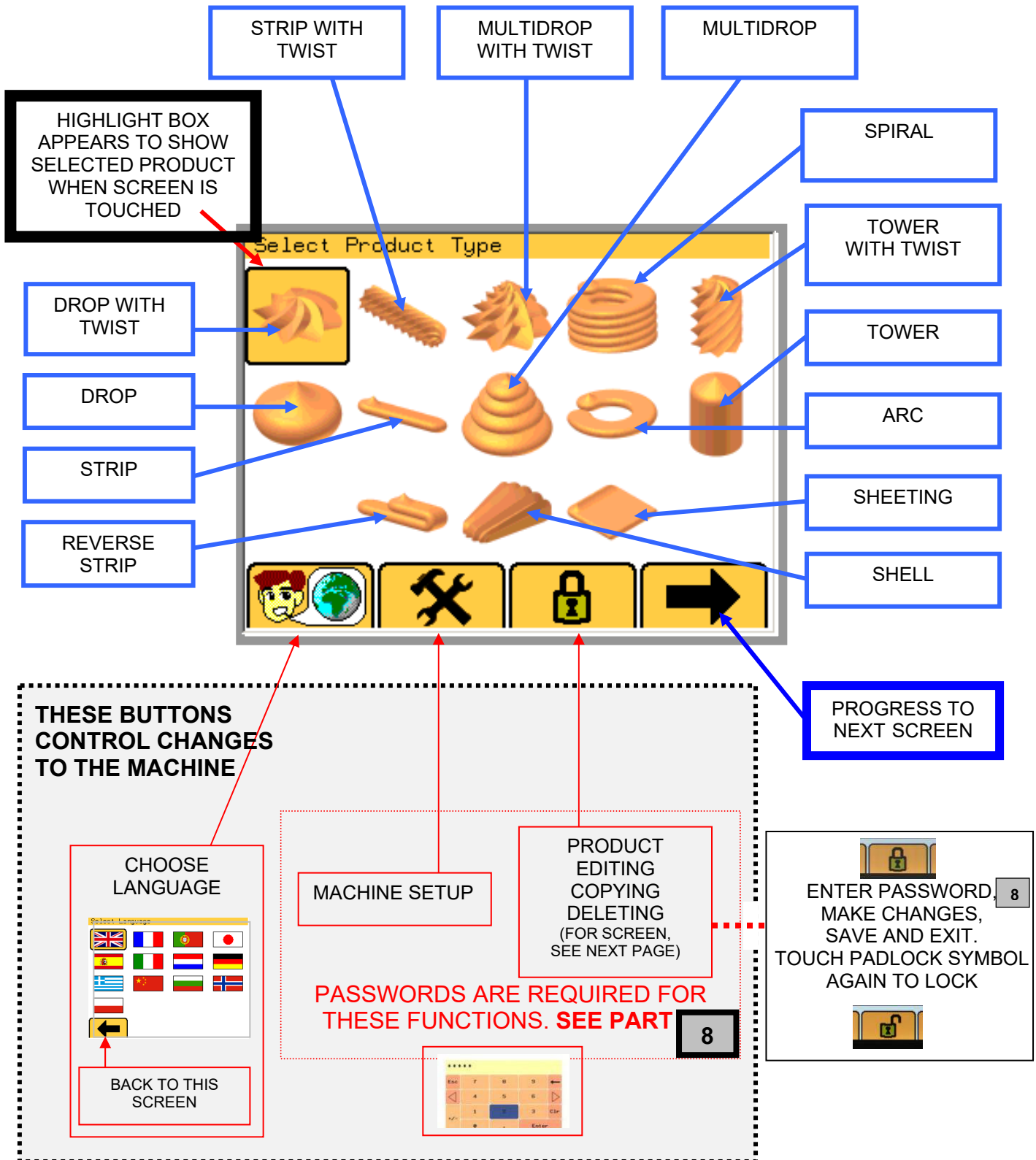

SELECT SAVED PRODUCT TYPE

OR CHOOSE EMPTY SLOT TO CREATE A NEW PROGRAM

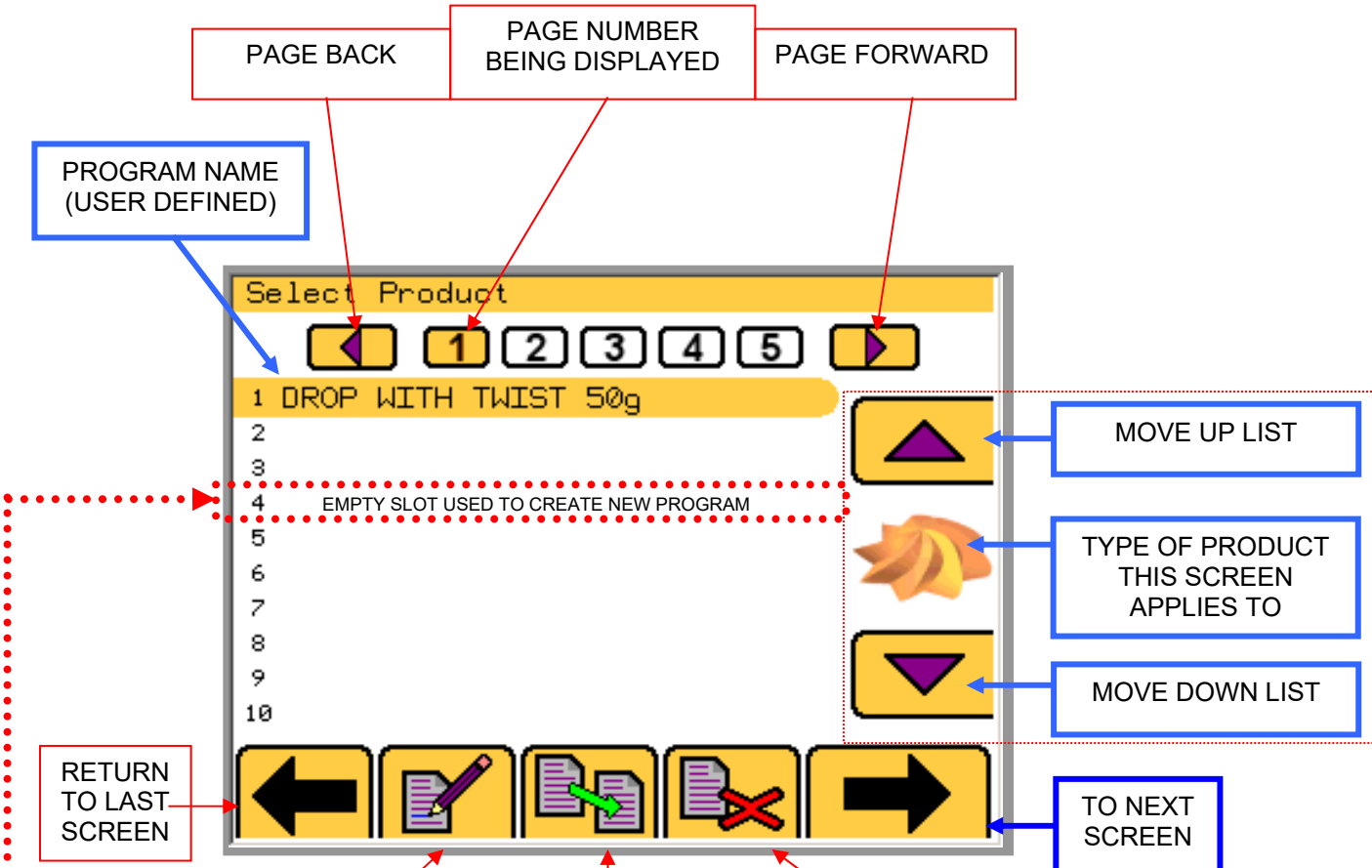

RETURN TO LAST SCREEN

MOVE UP LIST

TYPE OF PRODUCT THIS SCREEN APPLIES TO

MOVE DOWN LIST

TO NEXT SCREEN

EDIT
GOES TO EDIT SCREEN TO ADJUST PROGRAM OF SELECTED PRODUCT
GO TO PART **5**

COPY
ALLOWS COPYING OF SELECTED PROGRAM
GO TO PART **6**

DELETE
ALLOWS DELETION OF SELECTED PROGRAM
GO TO PART **7**

TO CREATE A NEW PROGRAM.

5

MOVE TO AND EDIT EMPTY PROGRAM SLOT (BLANK)
STANDARD DEFAULTS WILL BE APPLIED AS A STARTING POINT

MACHINE MUST BE SET AS SHOWN ON THE SCREEN.

- A. Check template type (Rotary/Non-rotary)
- B. Check nozzle type (Number)
- C. Template number
- D. Check hopper type (Soft dough/Hard dough)

THEN PRESS CONFIRM BUTTON. 

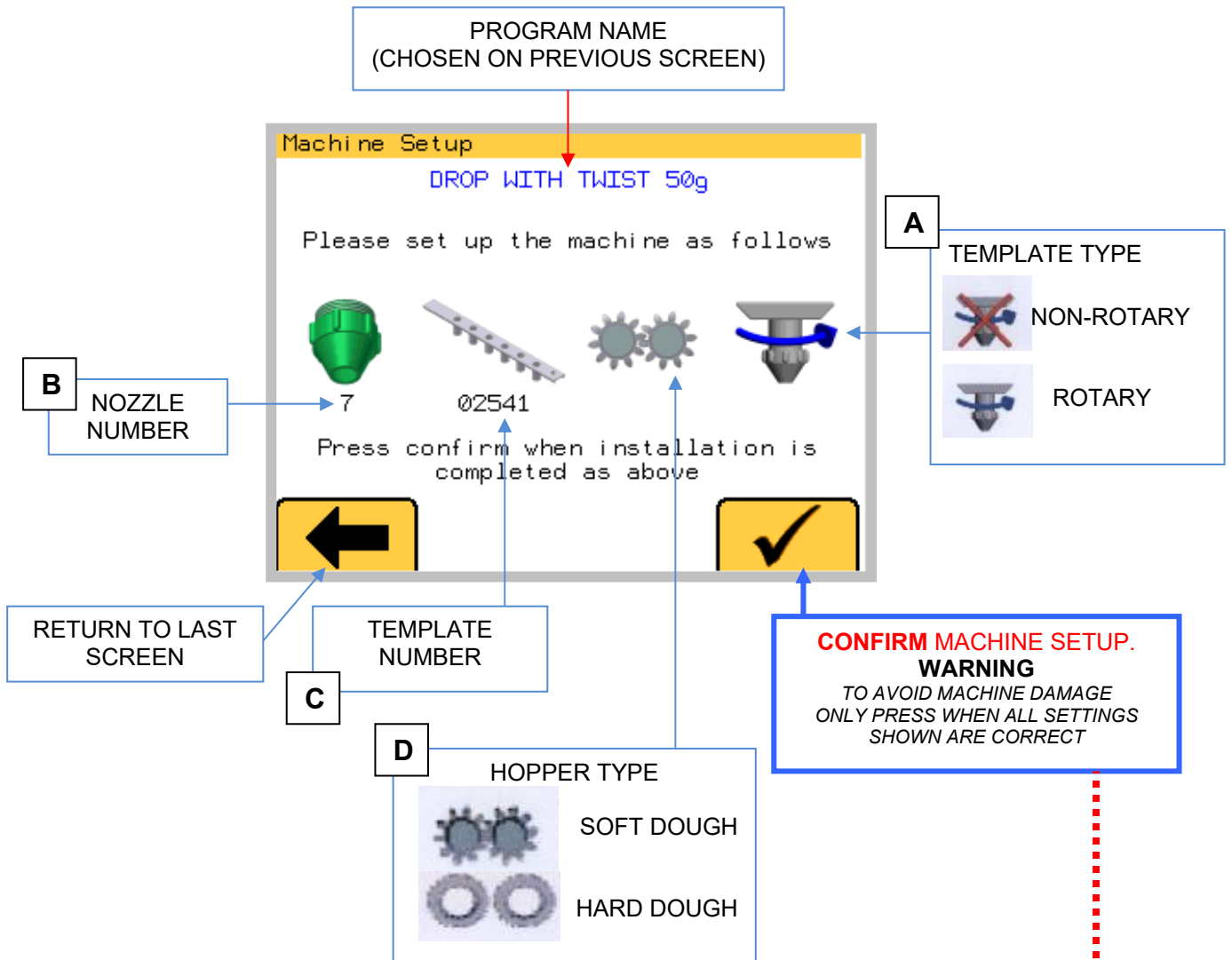

TO AVOID MACHINE DAMAGE
ONLY PRESS CONFIRM BUTTON WHEN ALL PARTS ATTACHED TO THE
MACHINE ARE AS SHOWN ON THE SCREEN

OPERATOR (START) SCREEN

4

MACHINE SHOULD BE SET AS SHOWN ON THE SCREEN.
THIS SCREEN CONTROLS THE ACTIONS REQUIRED BY THE OPERATOR.

1. Fill the hopper with the required product.
2. If the settings are correct, press the prime button to deposit a small amount onto a spare tray until all nozzles are depositing equally.
3. Place tray in place
4. Press “start-manual” or “start-auto”.
5. Press “stop” at any time to stop the program, lower the conveyor and return the tray.

Note: Temporary weight value adjustments can be made but the setting is not saved in the program.

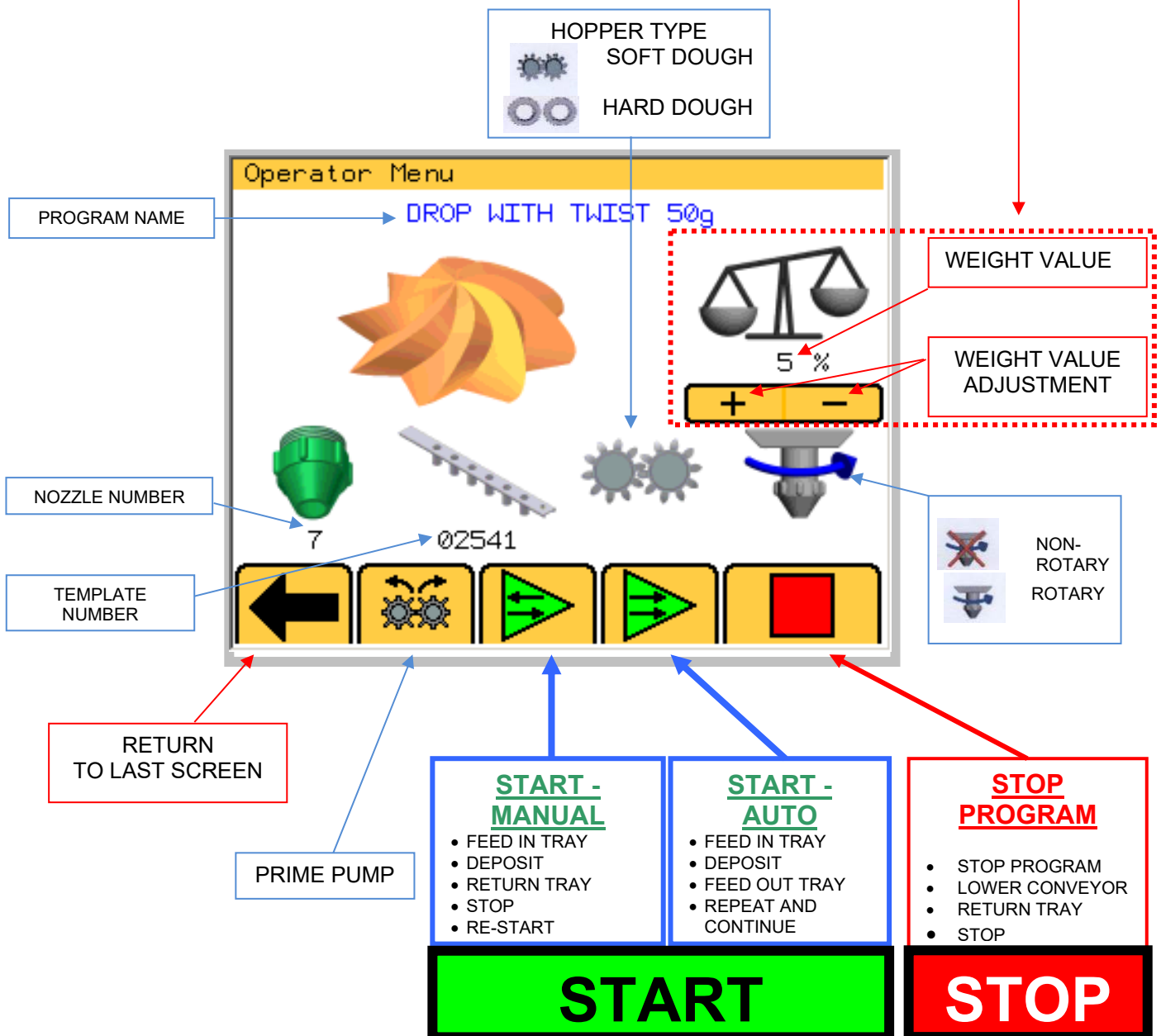

EDIT AND SAVE SCREEN

5

**EXAMPLE:
DROP WITH
TWIST**

PROGRAM NAME
MUST BE ENTERED TO
ALLOW PROGRAM TO SAVE

PRODUCT QUANTITY
THIS IS A SETTING NUMBER AND
DOES NOT INDICATE A MEASURE OF
ACTUAL VOLUME

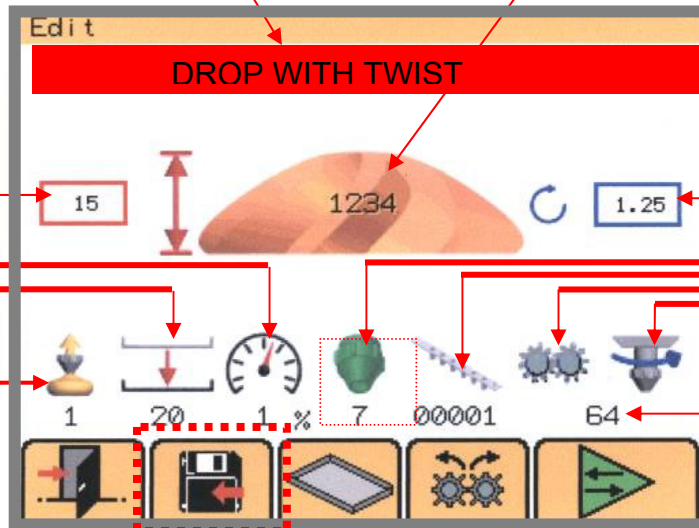

NOZZLE HEIGHT
(mm)
ABOVE TRAY SURFACE

NOZZLE ROTATIONS
NUMBER OF TURNS
DURING A DEPOSIT CYCLE

EXIT THIS SCREEN

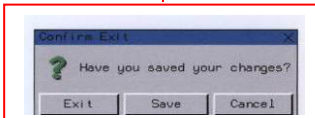

SAVE EDITS



**SUCK BACK
QUANTITY**

**TABLE
JOG DISTANCE (mm)**

**OVERALL
MACHINE SPEED
(% OF MAXIMUM)**

ENTER
TRAY
SETUP
SCREEN

GO TO PART
5A

**MAX HEIGHT FOR
HOPPER/TEMPLATE
COMBINATION**

**START
MANUAL MODE**

**PRIME PUMP
(SOFT DOUGH SHOWN)**

NOTE

**A RED BACKGROUND
TO ANY SETTING MEANS
THAT THE VALUE MUST
BE CORRECTED
BEFORE STARTING**

TEMPLATE TYPE
ROTARY
NON-ROTARY

SELECT HOPPER
HARD DOUGH
SOFT DOUGH

TEMPLATE NUMBER
ENTER VIA KEYPAD
THAT APPEARS WHEN
PRESSED

CHOOSE **NOZZLE TYPE**

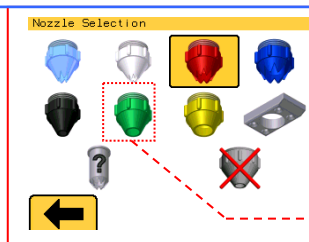

**EXAMPLE:
MULTIDROP
WITH TWIST**

DEPOSIT QUANTITY FOR EACH LAYER

SETTING ERROR INDICATOR
BOXES TURN RED WHEN INCORRECT SETTING MADE

NOZZLE HEIGHT (mm) FOR EACH LAYER

NOZZLE HEIGHT (mm) FROM TRAY SURFACE

NUMBER OF TURNS FOR EACH LAYER (-VE VALUES POSSIBLE)

PRIME PUMP (HARD DOUGH SHOWN)

OTHER SETTING BUTTONS ARE THE SAME AS LAST PAGE

Settings Error dialog box: Settings Error, [burger icon with red X], OK

Screen content: Edit, MULTIDROP, 0, 250, 500, 1210, 0.00, 1.00, 1.00, 1.00, 300, 10, 90%, 0, 00001, 43, [burger icon], [down arrow], [gauge], [nozzle], [gear with X], [saw blade], [gears], [burger icon]

**EXAMPLE:
SHEETING /
STRIP**

DEPOSIT QUANTITY FOR BEGINNING OF PRODUCT

DEPOSIT QUANTITY FOR LENGTH

DEPOSIT QUANTITY FOR END OF PRODUCT (-VE VALUES POSSIBLE)

NOZZLE HEIGHT ABOVE TRAY SURFACE

LENGTH (mm) OF TRAY MOVEMENT

Screen content: Edit, TEST 12, 65, 7000, 20, 15, 700, 300, 5, 50%, 0, 00001, 64, [burger icon], [down arrow], [gauge], [nozzle], [gear with X], [saw blade], [gears], [burger icon]

**EXAMPLE:
"C" SHAPE
(ARC)**

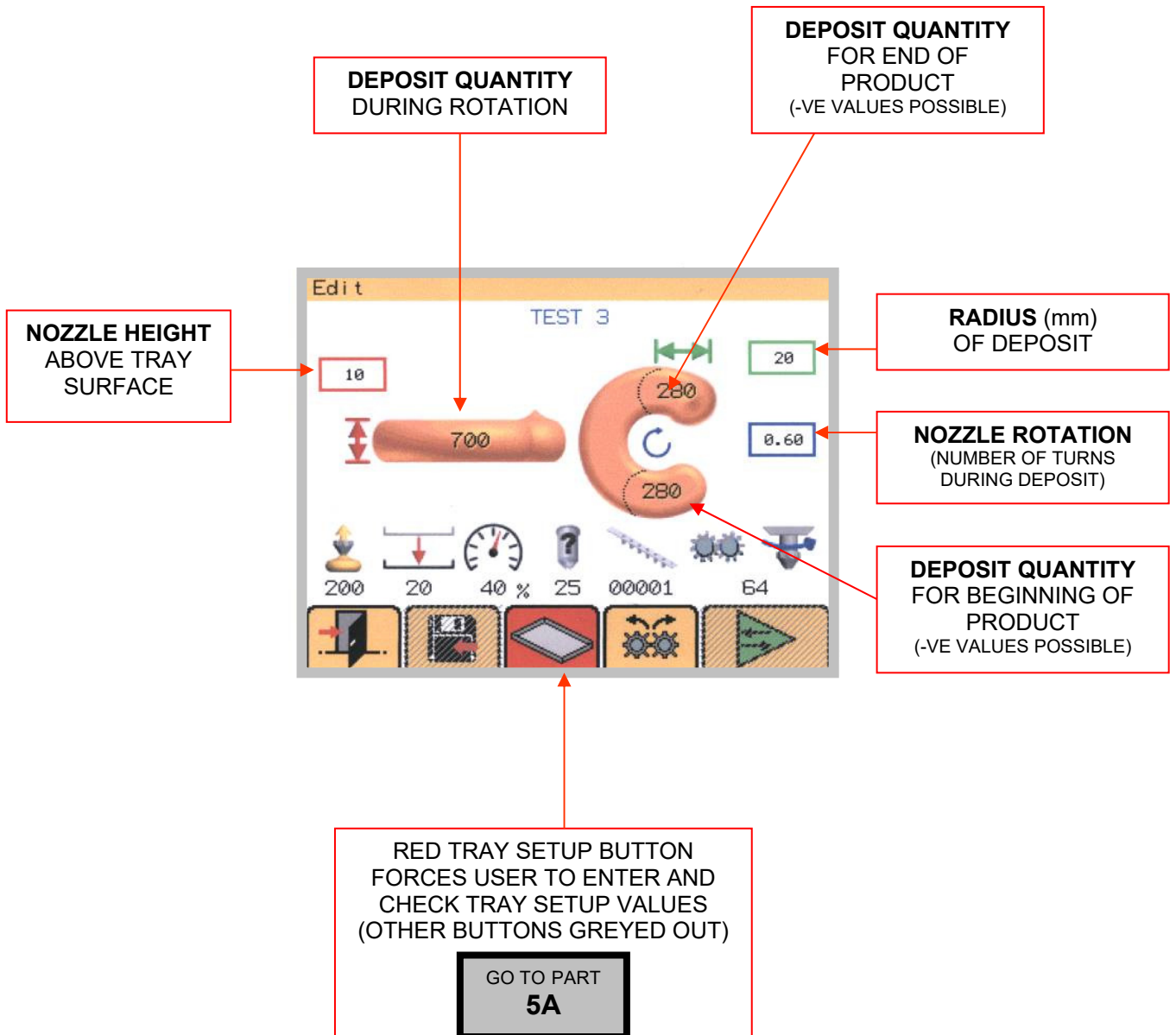

TRAY SETUP

5A



TOUCH WINDOWS AND ENTER VALUES VIA KEYPAD

DISTANCE (mm) TO 1ST ROW ON TRAY
(WHEN USING MANUAL OVER-RIDE)

DISTANCE (mm) BETWEEN ROWS
(WHEN USING MANUAL OVER-RIDE)

MANUAL OVER-RIDE FOR ROW SPACING
ON/OFF

DIRECTION OF TRAY MOVEMENT

TRAY FEED CONTROL

TRAY EDGE HEIGHT (mm)

PRODUCT TYPE

NUMBER OF ROWS PER TRAY

TRAY LENGTH (mm)

TO LAST SCREEN

WIPE BACK BUTTON
(DISTANCE MOVED BY TRAY AFTER DEPOSIT)

ACTIVATE WIRECUT ON/OFF
IF WIRECUT FITTED

WHEN WIRECUT SELECTED,
TOUCH SPEED AND ADJUST.
PRESS OK.

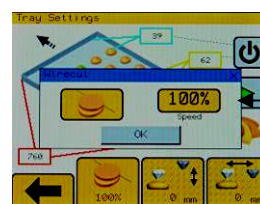
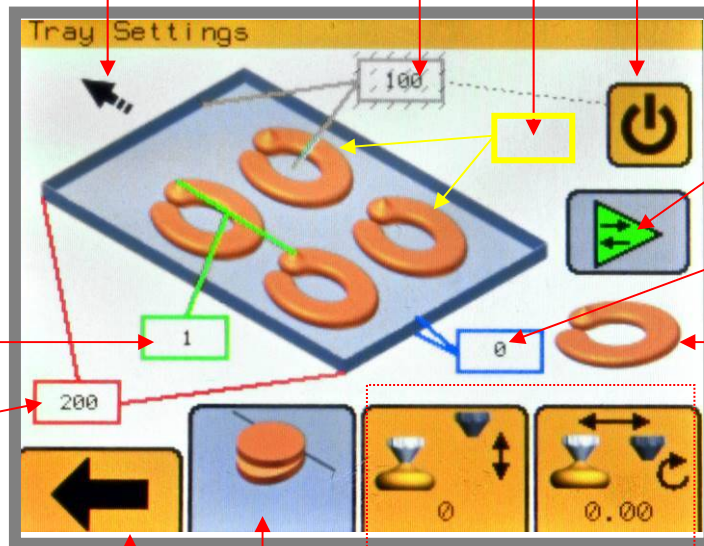

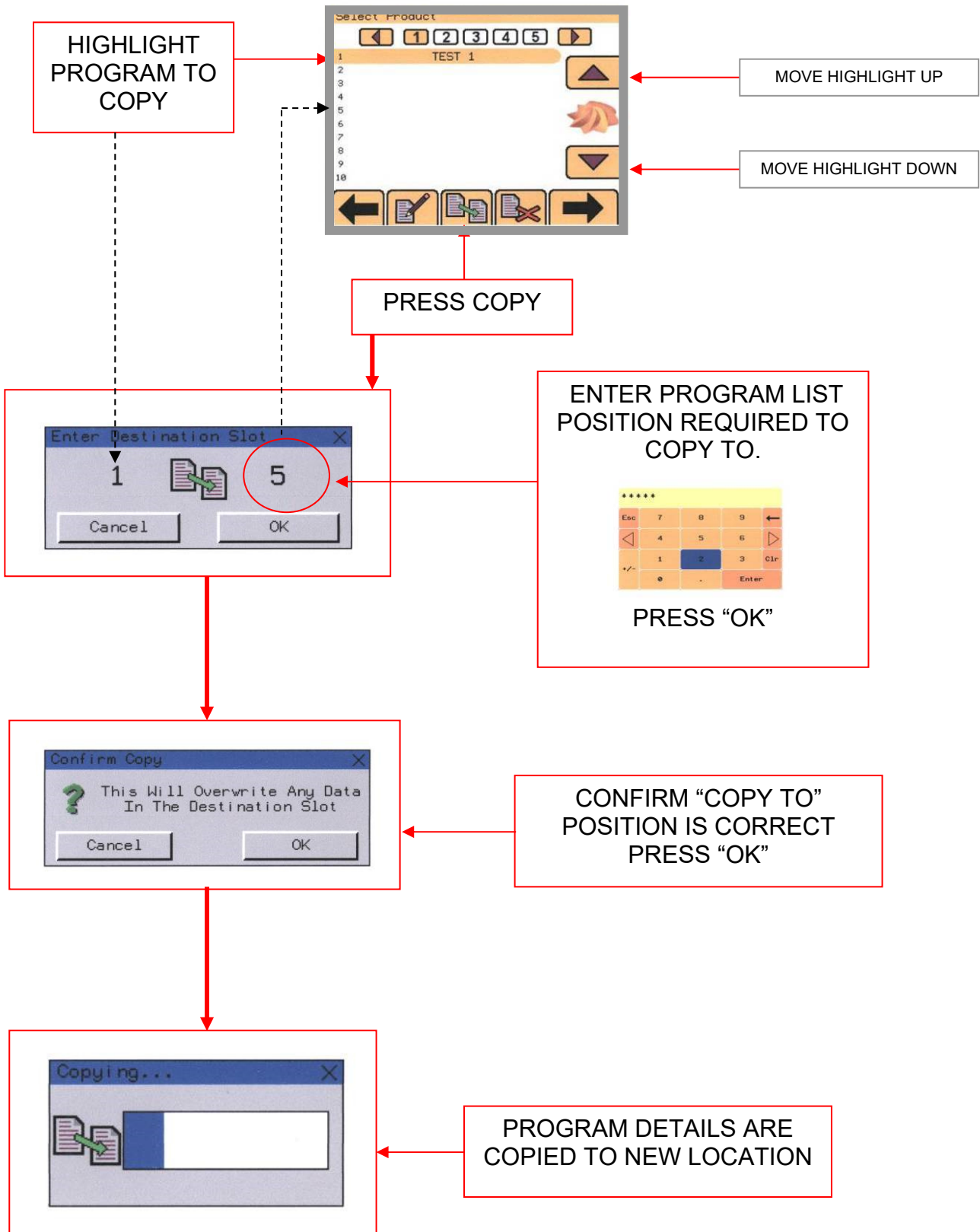

DELETE

7

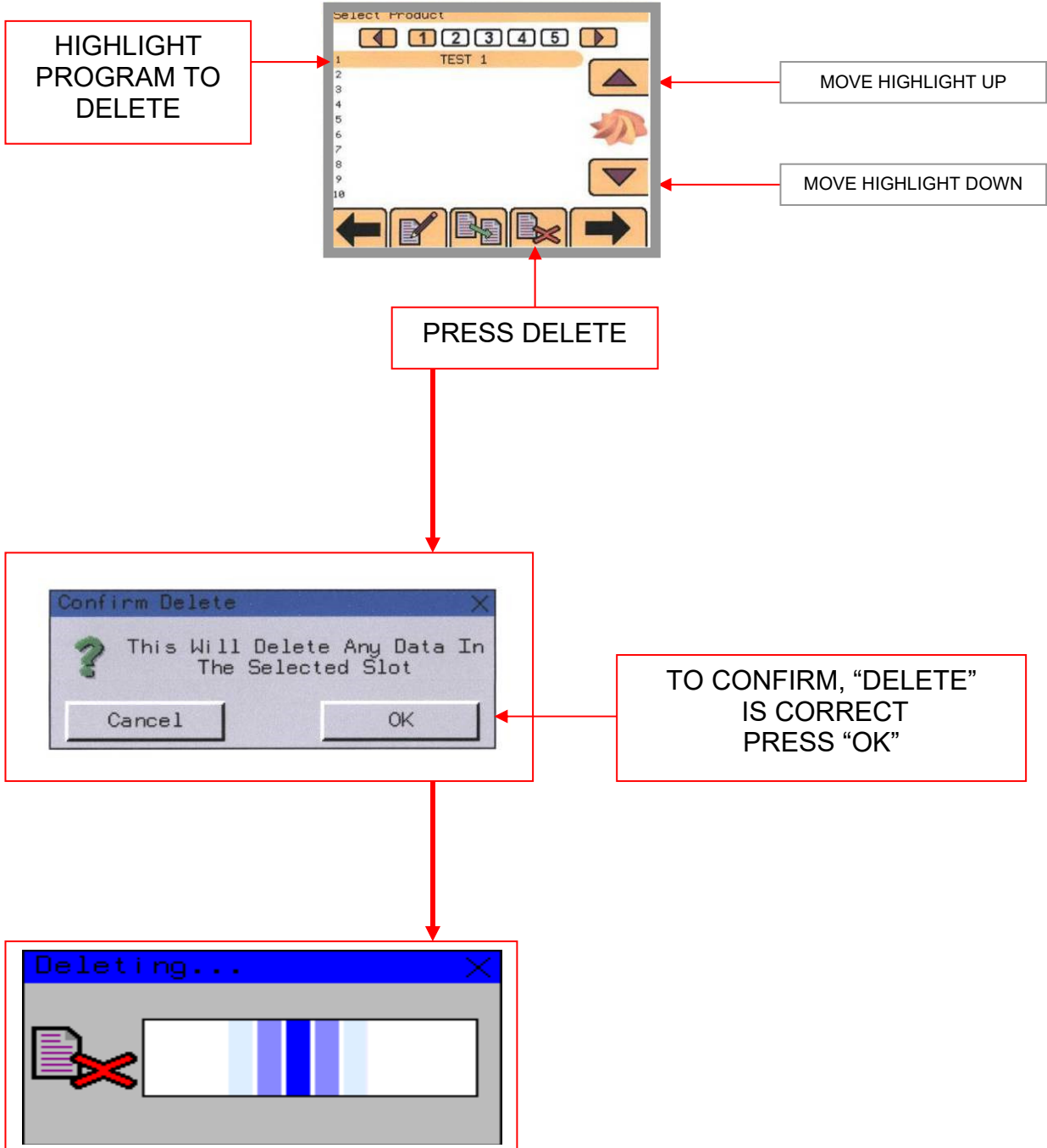

PASSCODES

SUGGESTION

To stop unauthorised changes to the Omega setup, it is suggested that this page is removed from this manual and kept in a safe place for future reference. If tampering could be a problem, It is also a good idea to change the passcodes at regular intervals.

CAUTION

DO NOT ATTEMPT TO MAKE ADJUSTMENTS UNLESS YOU ARE FULLY AWARE OF THE RESULTS

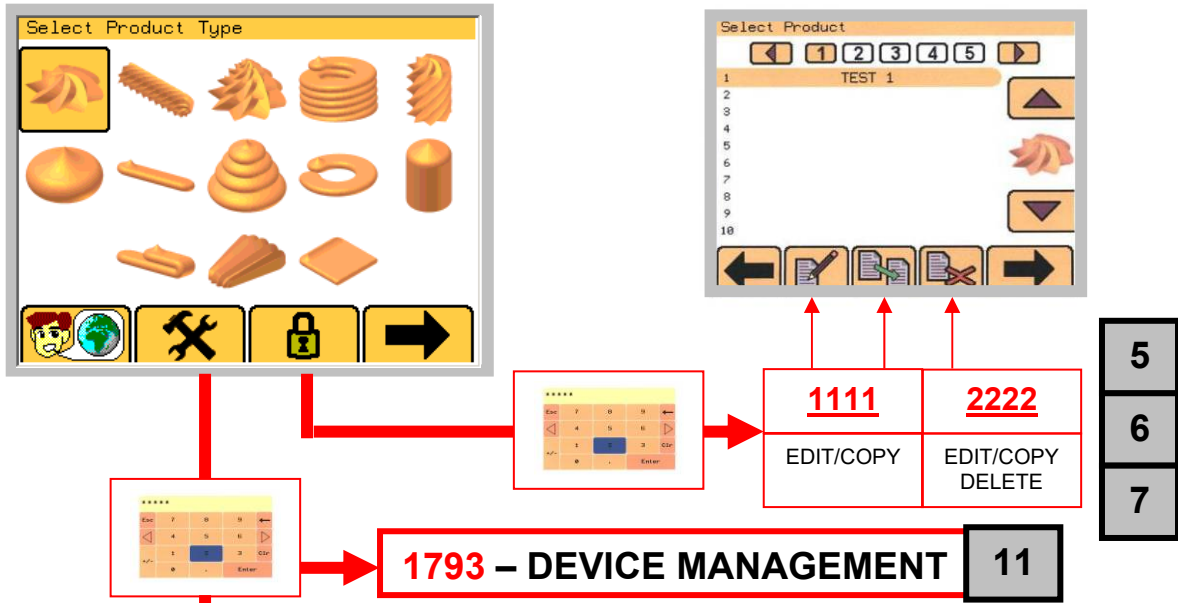

561234 - CHANGE PASSCODE

6 CHANGE EDIT/COPY PASSWORD

7 CHANGE EDIT/COPY/DELETE PASSWORD

1234 - SCREEN ADJUSTMENT

FINE / COARSE

THIS SECTION IS FOR TRAINED ENGINEERS ONLY

3142 -- ENGINEERING SETTINGS

OR

2808 -- DIAGNOSTICS

OR

RESET FACTORY DEFAULTS
[01554777460](tel:01554777460)

ENGINEERING SETTINGS (1)

9/1

THIS SECTION IS FOR TRAINED ENGINEERS ONLY

The screenshot shows the 'Engineering Settings 1' screen with the following parameters and controls:

- TRAY UNLOAD DISTANCE MANUAL:** 100 mm. Callout: IN MANUAL MODE: DISTANCE THE LEADING EDGE OF THE TRAY IS BROUGHT BACK PASSED THE TRAY SENSOR, WHEN RETURNING TO OPERATOR.
- TRAY SEARCH:** 320 Speed. Callout: SPEED VALUE THAT TRAY IS FED UP TO TRAY SENSOR.
- TRAY SEARCH TIME-OUT:** 3 Minutes. Callout: TRAY SEARCH TIMEOUT.
- TRAY REFERENCE MODE:** EDGE. Callout: HOME OR EDGE.

Navigation buttons at the bottom:

- EXIT THIS SCREEN:** Represented by a door icon with a red arrow pointing out.
- GO TO NEXT SCREEN ENGINEERING SETTING 2 (NEXT PAGE):** Represented by a right-pointing arrow icon.

Two inset images show a numeric keypad with the '3' key highlighted, indicating the input for the search timeout setting.

CAUTION

DO NOT ATTEMPT TO MAKE ADJUSTMENTS UNLESS YOU ARE FULLY AWARE OF THE RESULTS

ENGINEERING SETTINGS (2)

THIS SECTION IS FOR TRAINED ENGINEERS ONLY

The screenshot shows the 'Engineering Settings 2' screen with the following parameters and callouts:

- DEFAULT TRAY SPEED (MOVEMENT BETWEEN ROWS)**: Callout pointing to the '600' Speed value for 'DEFAULT TRAY'.
- DEFAULT JOG SPEED (VERTICAL AFTER DEPOSIT)**: Callout pointing to the '250' Speed value for 'DEFAULT JOG'.
- DEFAULT SPEED OF PUMP (100% VALUE IN PRODUCT SETUP PROGRAM)**: Callout pointing to the '700' Speed value for 'DEFAULT PUMP'.
- DEFAULT ACCELERATION FOR PUMP**: Callout pointing to the '3000' Acceleration value for 'DEFAULT PUMP'.
- DEFAULT ACCELERATION FOR JOG**: Callout pointing to the '5000' Acceleration value for 'DEFAULT JOG'.
- DEFAULT ACCELERATION FOR TRAY**: Callout pointing to the '5000' Acceleration value for 'DEFAULT TRAY'.
- PUMP SPEED WHEN USING PRIME BUTTON**: Callout pointing to the '250' Speed value for 'PRIME PUMP'.
- EXIT THIS SCREEN**: Callout pointing to the central navigation button.
- GO TO PREVIOUS SCREEN ENGINEERING SETTING 1 (PREVIOUS PAGE)**: Callout pointing to the left navigation button.
- GO TO NEXT SCREEN ENGINEERING SETTING 3 (NEXT PAGE)**: Callout pointing to the right navigation button.

Each callout box includes a small inset image of the numeric keypad used for setting these values.

CAUTION

DO NOT ATTEMPT TO MAKE ADJUSTMENTS UNLESS YOU ARE FULLY AWARE OF THE RESULTS

ENGINEERING SETTINGS (3)

9/13

THIS SECTION IS FOR TRAINED ENGINEERS ONLY

OFFSET HEIGHT VALUE IS FACTORY SET AND SHOULD NOT BE CHANGED UNLESS INSTRUCTED TO DO SO. DAMAGE TO THE MACHINE COULD OCCUR

OFFSET HEIGHT VALUE (mm)
HARD DOUGH HOPPER
NON-ROTARY TEMPLATE

OFFSET HEIGHT VALUE (mm)
HARD DOUGH HOPPER
ROTARY TEMPLATE

OFFSET HEIGHT VALUE (mm)
SOFT DOUGH HOPPER
ROTARY TEMPLATE

OFFSET HEIGHT VALUE (mm)
SOFT DOUGH HOPPER
NON-ROTARY TEMPLATE

DISTANCE (mm) FROM **HARD**
DOUGH HOPPER DEPOSITING
CENTRELINE TO TRAY EDGE
DETECTION POINT
(USED IN ROW SPACING CALCULATIONS)

DISTANCE (mm) FROM **SOFT**
DOUGH HOPPER DEPOSITING
CENTRELINE TO TRAY EDGE
DETECTION POINT
(USED IN ROW SPACING CALCULATIONS)

EXIT
THIS SCREEN

GO TO PREVIOUS SCREEN
ENGINEERING SETTING 2
(PREVIOUS PAGE)

GO TO NEXT SCREEN
ENGINEERING SETTING 4
(NEXT PAGE)

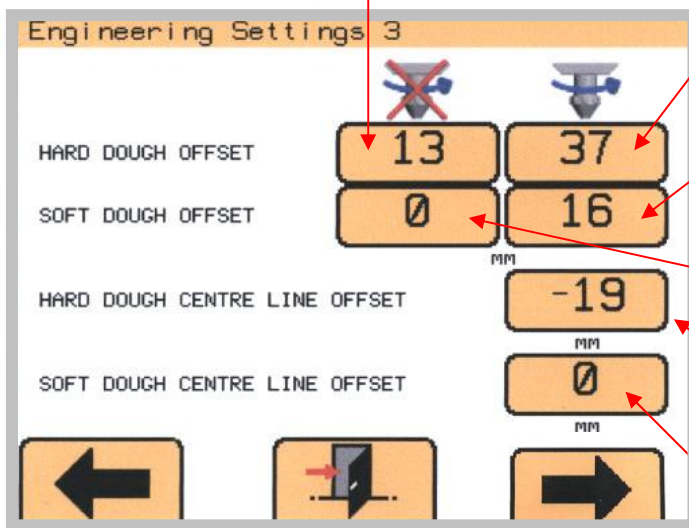

CAUTION

DO NOT ATTEMPT TO MAKE ADJUSTMENTS UNLESS YOU ARE FULLY AWARE OF THE RESULTS

THIS SECTION IS FOR TRAINED ENGINEERS ONLY

GEARBOX RATIOS

The screenshot displays the 'Engineering Settings 4' interface. It features four rows of gear ratio settings, each with a label, a numerical value, and a multiplier:

Setting	Value	Multiplier
PUMP GEARBOX RATIO	28	1
TRAY GEARBOX RATIO	10	1
JOG GEARBOX RATIO	15	1
ROTARY GEARBOX RATIO	10	1

At the bottom of the screen are three navigation buttons: a left arrow, a central button with a door icon and the text 'EXIT THIS SCREEN', and a right arrow. Red arrows point from external labels to these buttons and the corresponding rows in the table.

External labels and their connections:

- PUMP** points to the Pump Gearbox Ratio row.
- TRAY** points to the Tray Gearbox Ratio row.
- JOG** points to the Jog Gearbox Ratio row.
- ROTARY** points to the Rotary Gearbox Ratio row.
- GO TO PREVIOUS SCREEN ENGINEERING SETTING 3 (PREVIOUS PAGE)** points to the left arrow button.
- EXIT THIS SCREEN** points to the central door icon button.
- GO TO NEXT SCREEN ENGINEERING SETTING 5 (NEXT PAGE)** points to the right arrow button.

CAUTION

DO NOT ATTEMPT TO MAKE ADJUSTMENTS UNLESS YOU ARE FULLY AWARE OF THE RESULTS

THIS SECTION IS FOR TRAINED ENGINEERS ONLY

WIPE BACK DEFAULT SETTINGS (SEE 5A)

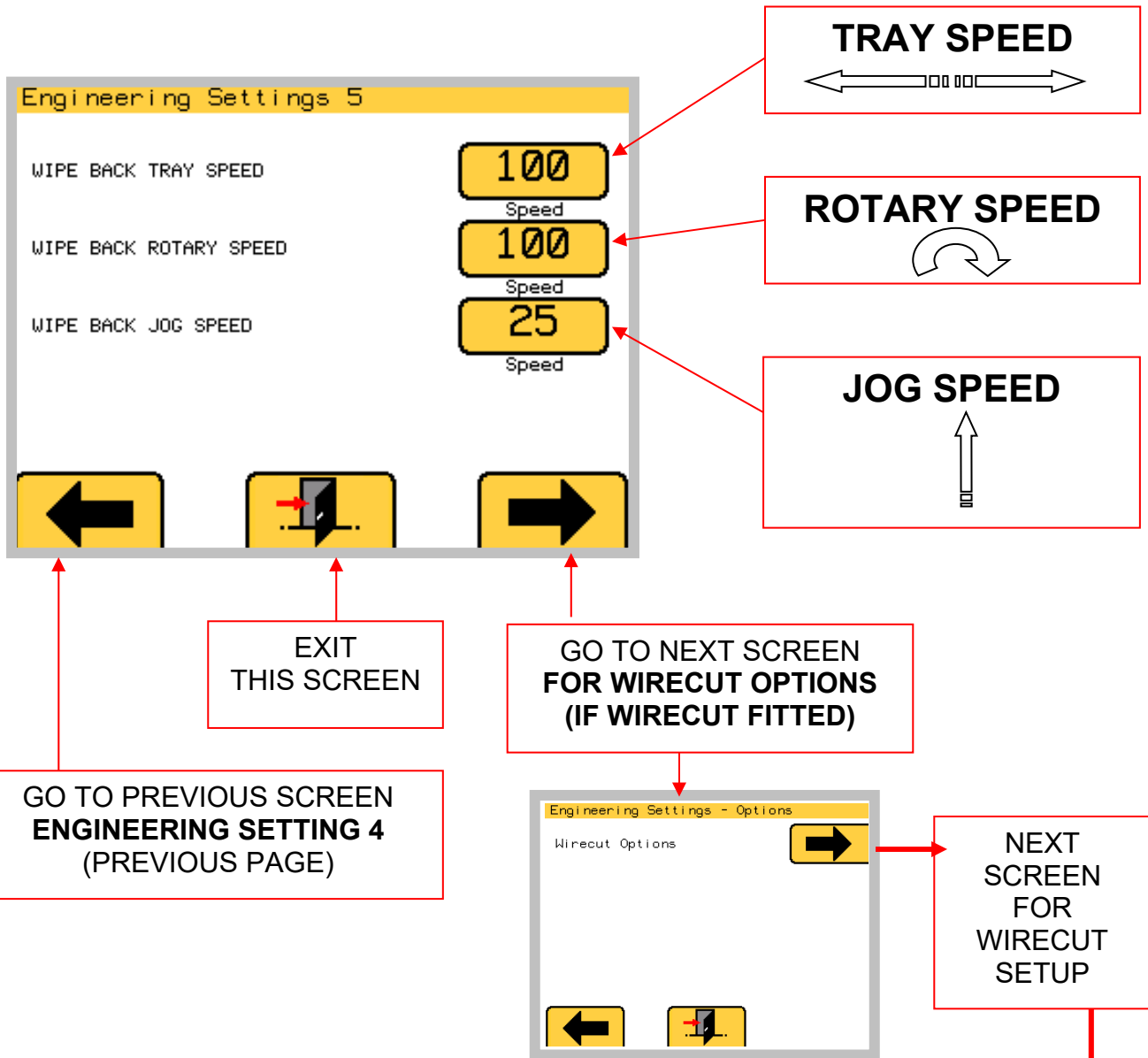

CAUTION

DO NOT ATTEMPT TO MAKE ADJUSTMENTS UNLESS YOU ARE FULLY AWARE OF THE RESULTS

NEXT PAGE

WIRECUT SETTINGS

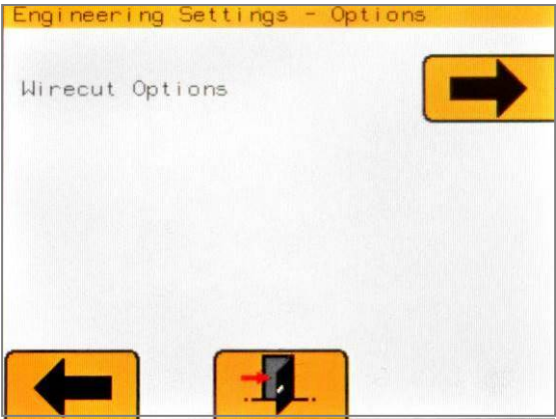

PROCEED TO WIRECUT SETTINGS PAGE

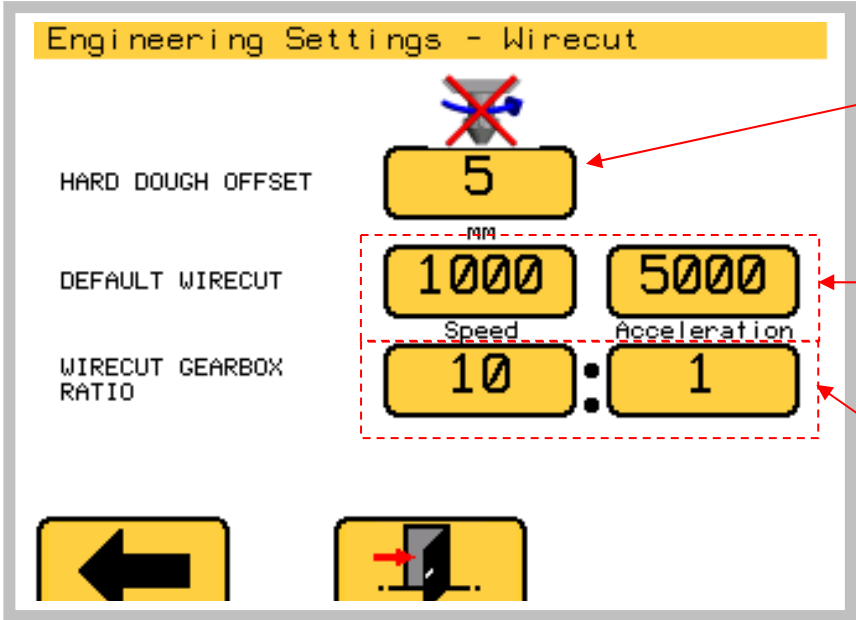

HARD DOUGH OFFSET

WIRECUT SPEED + ACCELERATION

WIRECUT GEARBOX RATIO

EXIT ENGINEERING SETTINGS

GO TO PREVIOUS SCREEN ENGINEERING SETTING 4 (PREVIOUS PAGE)

CAUTION
DO NOT ATTEMPT TO MAKE ADJUSTMENTS UNLESS YOU ARE FULLY AWARE OF THE RESULTS

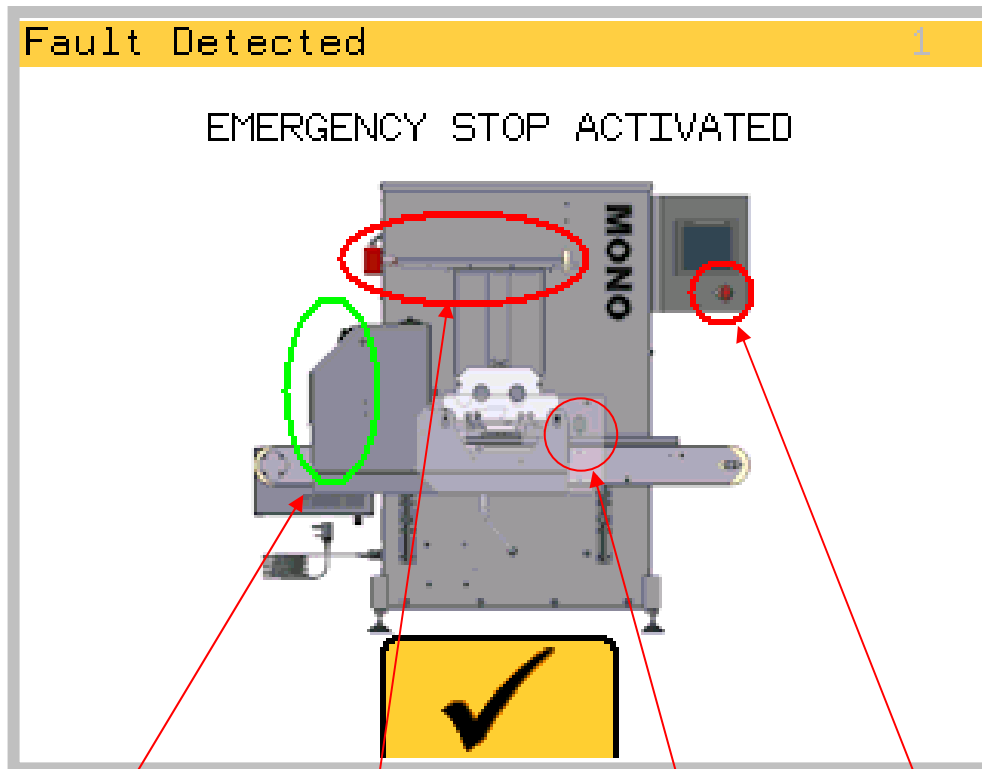

WIRECUT
COVER
(IF FITTED)

HOPPER COVER

SAFETY BEAM

STOP BUTTON

THIS SCREEN INDICATES A FAULT CONDITION IN THE SAFETY AREAS.

WHEN **RED**, CLOSE COVER OR CLEAR OBSTRUCTIONS TO CLEAR FAULT.
WHEN INDICATOR GOES **GREEN**, FAULT HAS BEEN CORRECTED AT THAT POSITION.

WHEN ALL FAULTS HAVE BEEN CORRECTED, PRESS  BUTTON TO CLEAR SCREEN

IF THE FOLLOWING SCREEN APPEARS, CHECK THAT THE TABLE MOVEMENT ETC. IS NOT JAMMED WITH SOMETHING. IF IT IS, CLEAR THE OBSTRUCTION AND PRESS  TO PROCEED.

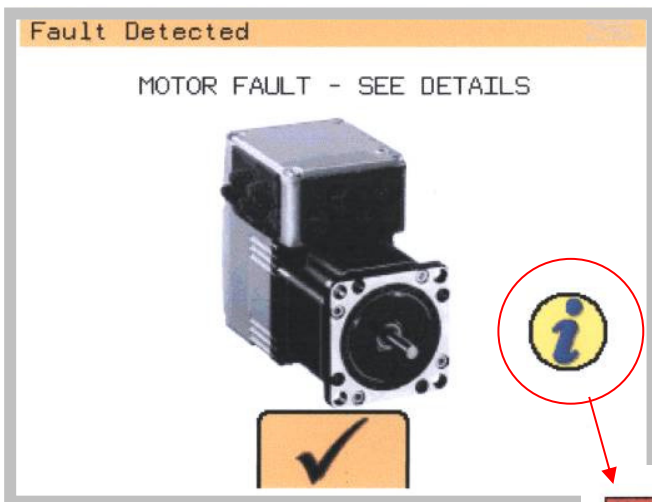

PRESS THIS BUTTON IF MORE INFORMATION IS REQUIRED AS TO WHICH MOTOR IS AT FAULT

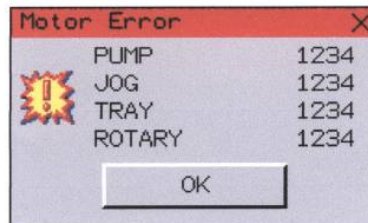

IF THE FAULT IS NOT OBVIOUS AND NOT ABLE TO BE CLEARED SAFELY, A SUITABLY TRAINED ENGINEER SHOULD BE CALLED

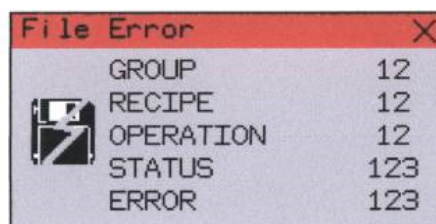

ERROR WHEN LOADING/SAVING RECIPE DATA TO HMI STORAGE CARD
PLEASE CONTACT SERVICE DEPT. / ENGINEER IF PROBLEM PERSISTS

DEVICE MANAGEMENT

Device Management allows you to **backup / restore recipes and settings.**
and **update your system software.**

How to access the device management functions

1. Touch the **Settings** icon at the bottom of the screen (Hammer and Spanner).

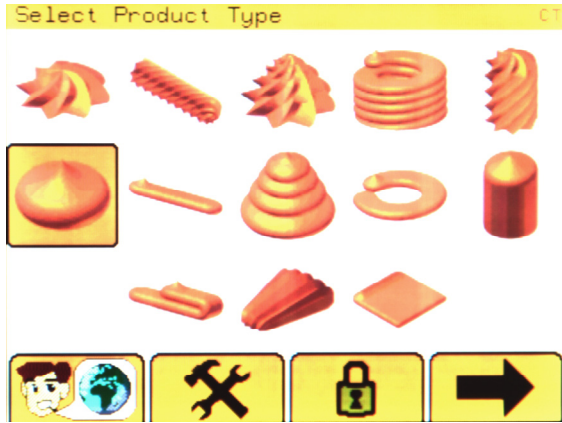

2. Input the Password **1793** and press the **Enter** button.



3. If backing up or restoring recipes/settings, now insert a USB memory stick (pen drive) into the USB port below the control panel enclosure. **(The software update requires this step later).**



4. When the **Device Management Screen** appears, select from Backup, Update, and Restore.



BACKUP

1. Touch the **BACKUP** button on the Device Management Screen.
2. Touch **Back up to USB** to save recipes and settings to the USB memory stick (pen drive).

Note that any existing recipes or settings on the USB memory stick are erased.



3. Touch the **Back** button (bottom of the screen) to return to the Select Product Type screen.

UPDATE (Software Update Only)

1. Touch the **UPDATE** button on the Device Management Screen.
2. When the screen below is displayed, insert the USB memory stick (pen drive) containing the software update. The update will then automatically begin.



3. Touch the **Back** button (bottom of the screen) to return to the Select Product Type screen.

RESTORE

1. Touch the **RESTORE** button on the Device Management Screen.
2. Touch **Restore From USB** to import recipes and settings from the USB memory stick (pen drive) to the Omega machine.

Note that this overwrites existing recipes and settings on the Omega machine.



3. Touch the **Back** button (bottom of the screen) to return to the Select Product Type screen.

RESTORE (Advanced)

1. Touch the **RESTORE** button on the Device Management Screen.
2. Touch the **Advanced** button at the bottom-right of the screen.
3. Touch **RESTORE RECIPES** to import only recipes from the USB memory stick (pen drive) to the Omega machine. **Note that this overwrites existing recipes on the Omega machine.**
4. Touch **RESTORE SETTINGS** to import only settings from the USB memory stick (pen drive) to the Omega machine. **Note that this overwrites existing settings on the Omega machine.**

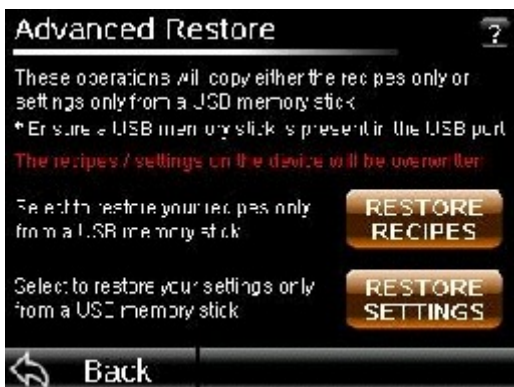



- WARNING**
- This appliance must be maintained at regular intervals. The frequency of maintenance will depend upon your specific use and location. The maximum service interval should be 12 months.
 - Service and maintenance should only be undertaken by suitably qualified, trained, and competent engineers.
 - You must immediately report any damage or defect arising with the appliance.
 - Unsafe equipment is dangerous. Do not use the appliance. Isolate the power supply and contact MONO or your appointed service agent.

Under most conditions the machine only needs to be kept clean and used as instructed in this manual.



WARNING: Under no circumstances use a water hose or pressure washer to clean this machine.

Check and Maintenance Schedule

Operation	Daily	Weekly	Monthly	Yearly
Clean depositor as per instructions in the manual	*			
Check condition of supply lead and plug	*			
Check fit of guards	*			
Clean under conveyor belts		*		
Check hopper seals		*		
Check end cap seals		*		
Check condition and tension of conveyor (adjust or replace, as required)			*	
Check end cap bearings			*	
Check alignment of sensor on guards			*	
Check tray sensor is secure			*	
Check condition of idle roller bearings				*
Check condition of drive shaft bearings				*
Check condition and tension of chain and grease as required				*
Grease slides as required				*
Adjust eccentric guide rollers as required				*
Adjust concentric guide rollers as required				*
Check and grease all slide plates as required				*
Check all motor mounts are tight				*
Inspect electrical connections and tighten as required				*
Replace the button battery (M251 controller) ⁽¹⁾				*

⁽¹⁾ Internal data can be lost if the battery is depleted and should be replaced every 1 to 2 years (depending on the ambient temperature).



WARNING: Under no circumstances should maintenance or cleaning of this product machine be done with the power connected.

12.0 SPARES AND SERVICE

Omega PLUS

If a fault arises, please do not hesitate to contact the Customer Service Department, quoting the **machine serial number** on the silver information plate of the machine and on the front cover of this manual

UK SERVICE, SPARES and OVERSEAS SUPPORT:

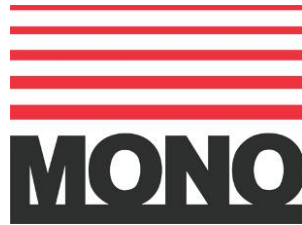

Queensway
Swansea West Industrial Estate
Swansea.
SA5 4EB
UK

email: spares@monoequip.com
Spares Tel. +44(0)1792 564039
Website: www.monoequip.com

Main Tel. 01792 561234

BASE MACHINE SPARES LIST**Omega PLUS -- WIRECUT VERSION**

Spares Item Description	Mono Part No.	Qty Req. per M/C
Deposit Gearbox	A900-11-097	1
Jog Gearbox	A900-11-092	1
Rotary Gearbox	A900-11-091	1
Tray Gearbox	A900-11-091	1
Concentric Guide Roller	A900-06-274	2
Eccentric Guide Roller	A900-06-273	2
V Slide	078-03-00016	1
Slide Plate	078-03-00027	1
Jog Drive Chain	A900-08-066	1
Simplex Sprocket 16T 1/2" Pitch	A900-07-071	1
Idler Sprocket 16T 1/2" Pitch	A900-07-072	1
Circlip-Ext Metric 14mm Dia	A900-01-280	1
Circlip-Ext Metric 24mm Dia	A900-01-193	1
Drive Shaft – Hopper	078-03-00015	1
Rotary Drive Shaft	078-03-00011	1
Drive Gear - Rotary Template	078-03-00010	1
Lip Seal (Rotary Drive Shaft)	A900-12-075	1
Lip Seal (Deposit Drive Shaft)	A900-12-079	1
End Guard (Earlier plastic version)	078-11-00036 078-11-00005)	1
Retainer – End Guard (Earlier plastic version)	078-11-00035 078-11-00002)	2
Spacer – 450mm/580mm Hopper	078-11-00003	1
Spacer – 400mm Hopper	078-11-00004	1
Seal-Rear Cover	A900-25-309	1

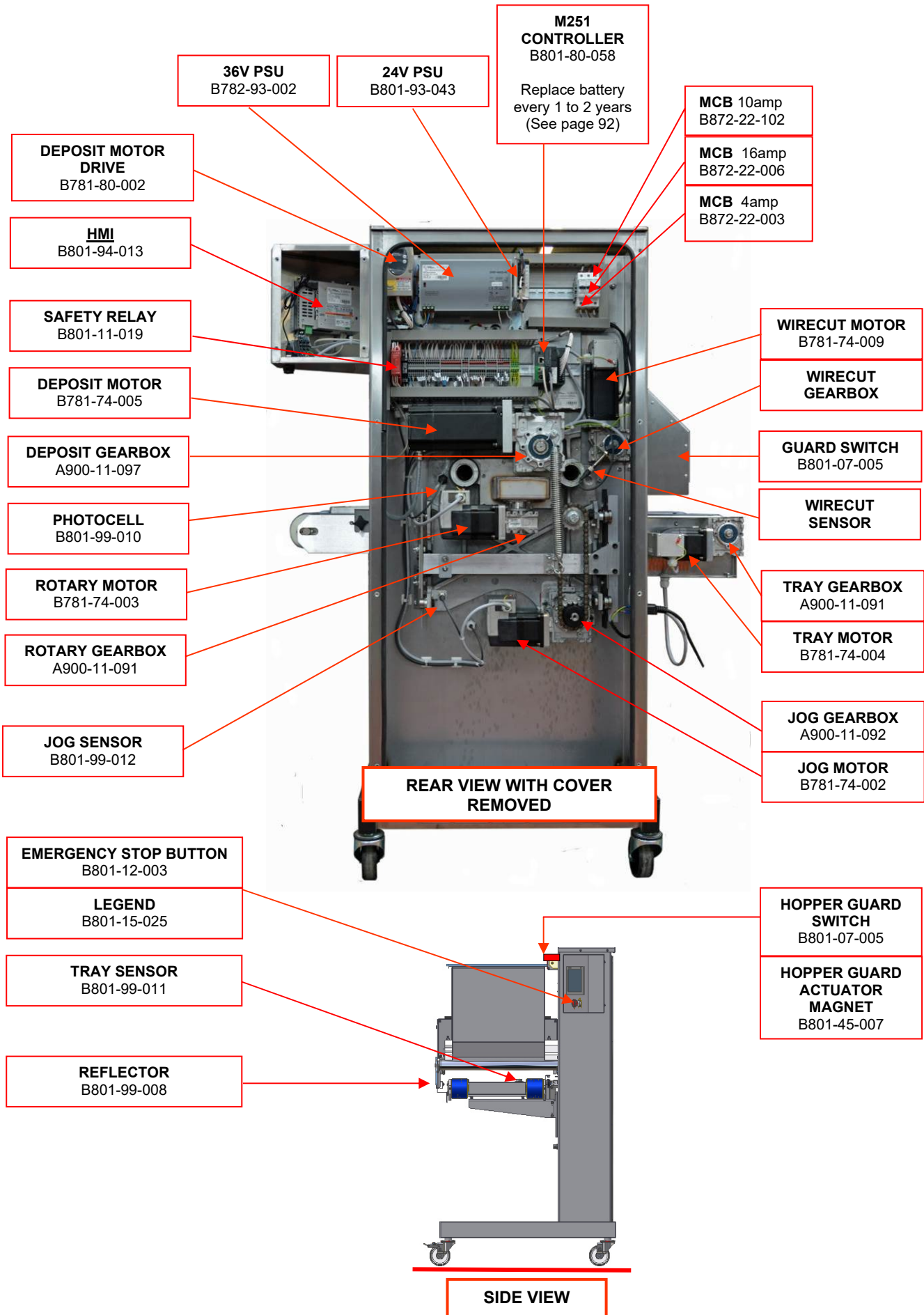

REAR VIEW WITH COVER REMOVED

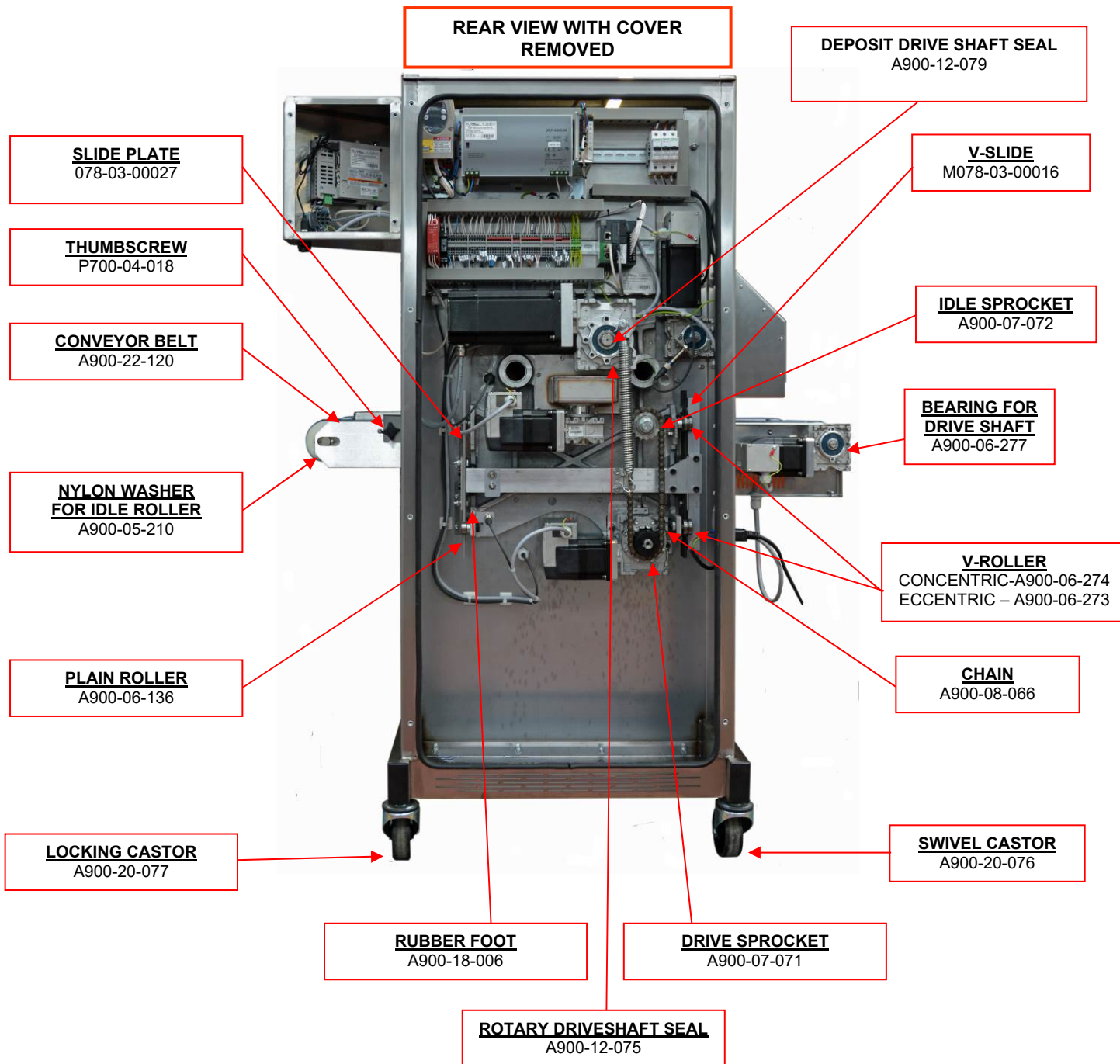

BASE MACHINE SPARES LIST**Omega PLUS -- NO WIRECUT VERSION**

Spares Item Description	Mono Part No.	Qty Req. per Machine
Deposit Gearbox	A900-11-097	1
Jog Gearbox	A900-11-092	1
Rotary Gearbox	A900-11-091	1
Tray Gearbox	A900-11-091	1
Concentric Guide Roller	A900-06-274	2
Eccentric Guide Roller	A900-06-273	2
V Slide	078-03-00016	1
Slide Plate	078-03-00027	1
Jog Drive Chain	A900-08-066	1
Simplex Sprocket 16T 1/2" Pitch	A900-07-071	1
Idler Sprocket 16T 1/2" Pitch	A900-07-072	1
Circlip-Ext Metric 14mm Dia	A900-01-280	1
Circlip-Ext Metric 24mm Dia	A900-01-193	1
Drive Shaft – Hopper	078-03-00015	1
Rotary Drive Shaft	078-03-00011	1
Drive Gear - Rotary Template	078-03-00010	1
Lip Seal (Rotary Drive Shaft)	A900-12-075	1
Lip Seal (Deposit Drive Shaft)	A900-12-079	1
End Guard (Earlier plastic version)	078-11-00036 078-11-00005)	1
Retainer – End Guard (Earlier plastic version)	078-11-00035 078-11-00002)	2
Spacer – 450mm/580mm Hopper	078-11-00003	1
Spacer – 400mm Hopper	078-11-00004	1
Seal-Rear Cover	A900-25-309	1

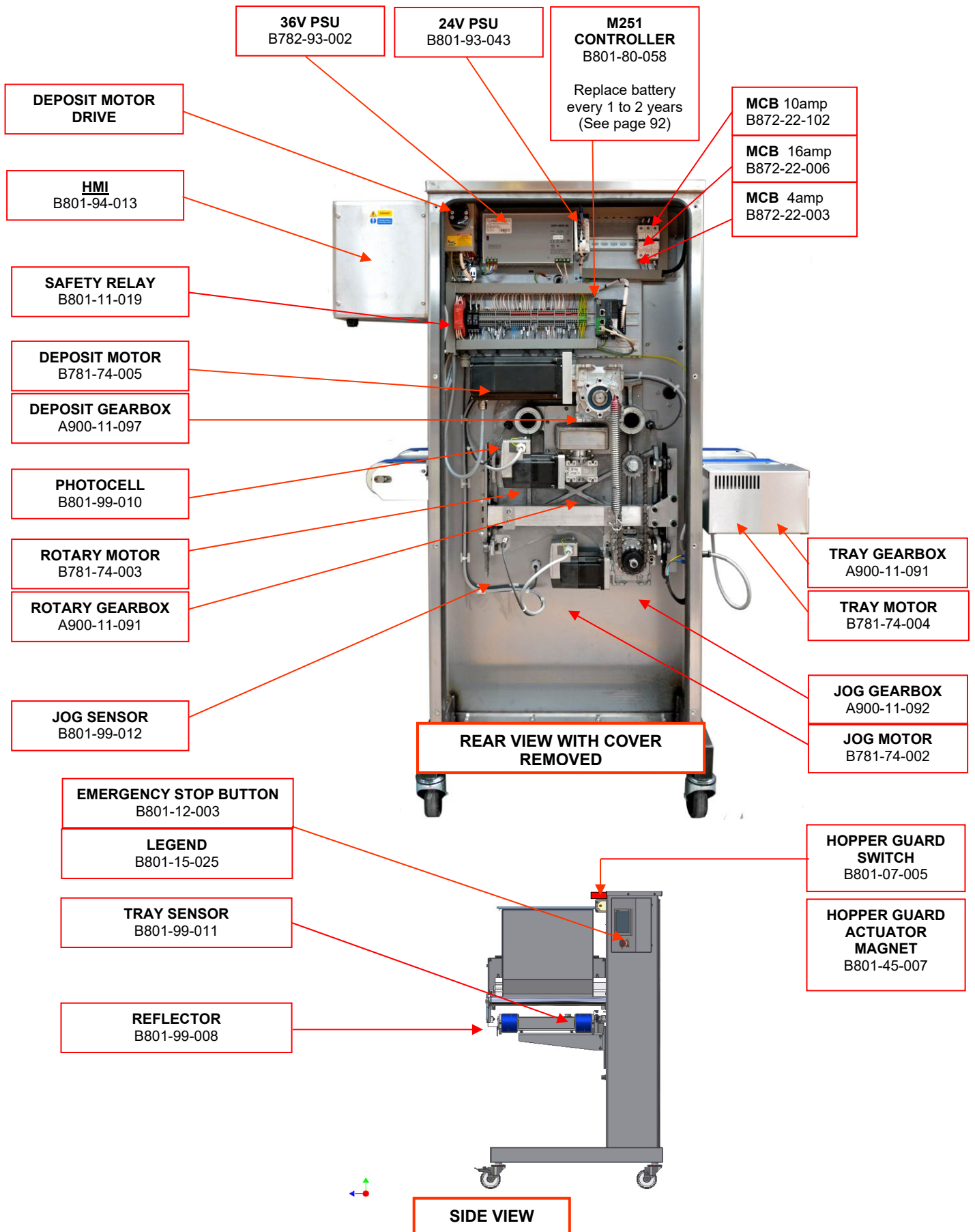

HARD DOUGH HOPPER PARTS

Omega PLUS ONLY

HOPPER FABRICATION

STANDARD CAPACITY

M078-09-00086 (400mm)
M078-09-00042 (450mm)
M078-09-00089 (580mm)

EXTENDED CAPACITY

M078-09-00087 (400mm)
M078-09-00088 (450mm)
M073-09-00092 (580mm)

WINGNUT
A900-04-147

UPPER END BLOCK (DRIVEN SIDE)
M078-09-00144

ROLLER OPTIONS

M078-KMX004 400mm
4MM GROOVE - ALUMINIUM

M078-KMX005 400mm
6MM GROOVE - ALUMINIUM

M078-KMX006 400mm
8MM GROOVE - ALUMINIUM

M078-KMX015 400mm
8MM GROOVE - PLASTIC

M078-KMX007 450mm
4MM GROOVE - ALUMINIUM

M078-KMX008 450mm
6MM GROOVE - ALUMINIUM

M078-KMX009 450mm
8MM GROOVE - ALUMINIUM

M078-KMX010 580mm
4MM GROOVE - ALUMINIUM

M078-KMX011 580mm
6MM GROOVE - ALUMINIUM

M078-KMX012 580mm
8MM GROOVE - ALUMINIUM

STANDARD(St Steel) ROLLERS

DRIVE	400MM	078-09-00066
	450MM	078-09-00060
	580MM	078-09-00074
DRIVEN	400MM	078-09-00067
	450MM	078-09-00061
	580MM	078-09-00075

UPPER END BLOCK (DRIVE SIDE)
M078-09-00143

LOWER END BLOCK (DRIVE SIDE)
M078-09-00141

THUMBSCREW
M078-09-00043

TEMPLATES TO CUSTOMER REQUIREMENTS

ROTARY

- SMALL BORE
- LARGE BORE

STANDARD

- SMALL BORE
- LARGE BORE

DIE

SHEETING

LOWER END BLOCK (DRIVEN SIDE)
M078-09-00142

POUR-THROUGH TOP GUARD (NOT SHOWN)

HARD DOUGH	400MM	078-11-00060
------------	-------	--------------

450MM	078-11-00061
580MM	078-11-00062



13.0 ELECTRICAL INFORMATION

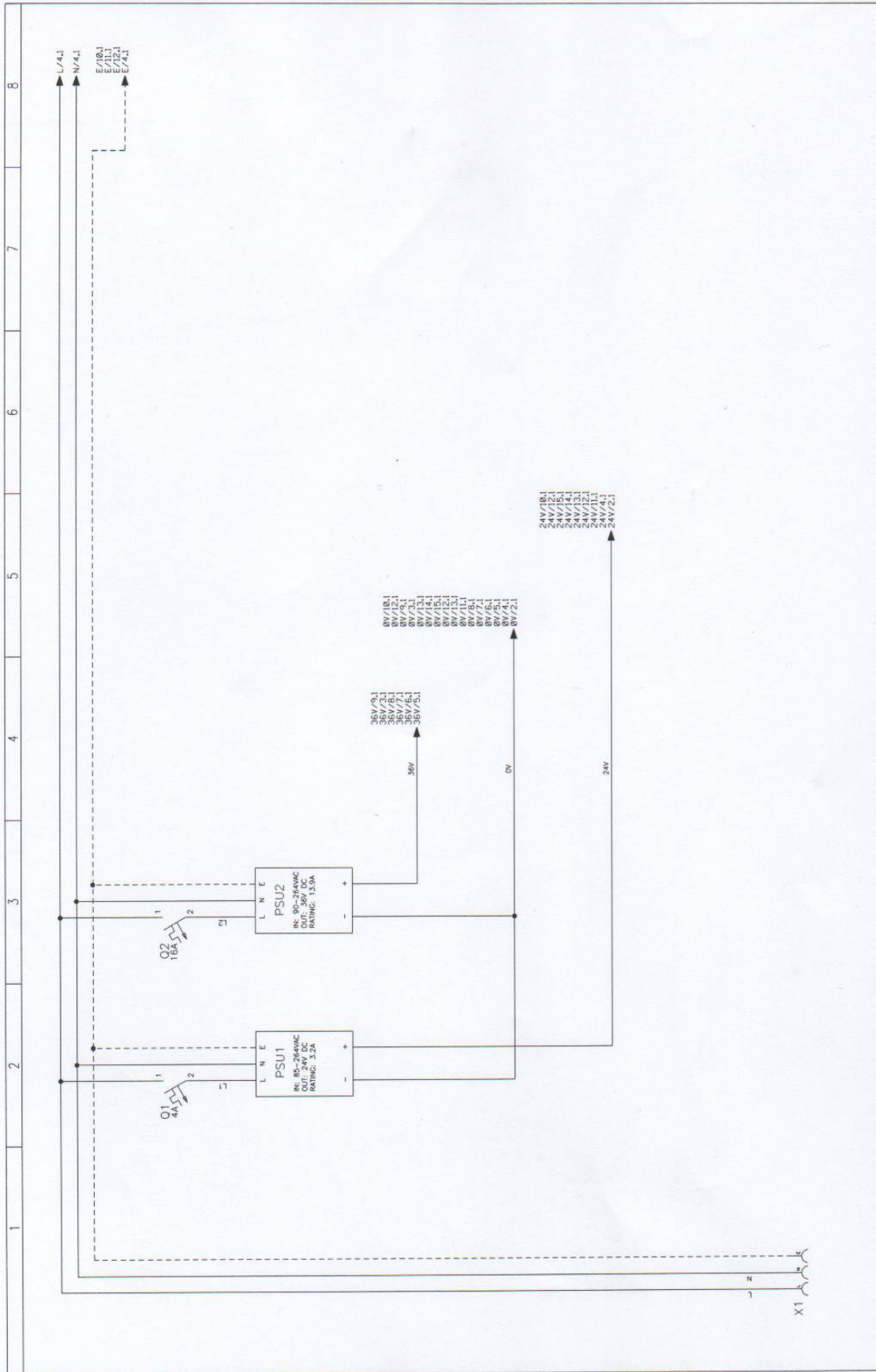

		MONO EQUIPMENT ONE ESTATE WEST IND PARK SWANSEA SA1 1 1L TEL: (01792) 542234 FAX: (01792) 542676 www.monosup.com		TITLE ELECTRICAL DISTRIBUTION		PROJECT DESCRIPTION OMEGA DEPOSITOR		PROJECT OMEGA_MK3B		INSTALLATION LOCATION OMEGA_MK3B		ELECTRICAL SPECIFICATIONS 240VAC 1PH+N+E 50HZ		ELECTRICALLY APPROVED BY ANGELA THOMAS		DRAWING NUMBER 079E25-00059		PAGE 1 OF 15		REV. A	
(X) DRAWN RO	(X) DATE 05/11/20	(X) REV. A	(X) DATE 02/11/20	(X) BY RO	(X) NOTES INITIAL RELEASE																

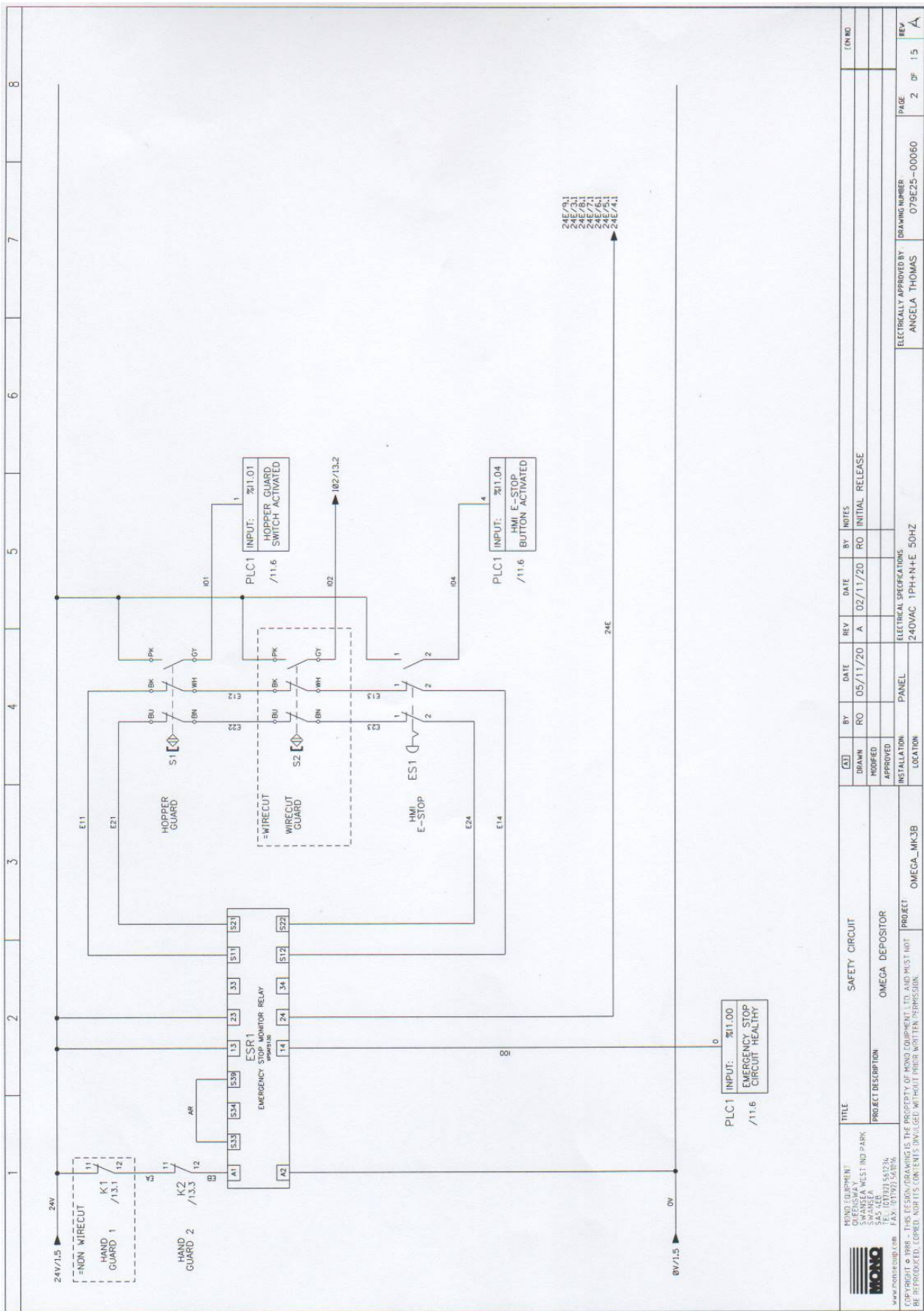

MIND EQUIPMENT		SAFETY CIRCUIT			REV	DATE	BY	NOTES
MIND EQUIPMENT SWANSEA WEST IND PARK SWANSEA SOMERSET BA15 2EJ TEL: (01792) 56224 FAX: (01792) 56276 www.mind-equip.com		OMEGA DEPOSITOR			01	05/11/20	RO	INITIAL RELEASE
PROJECT DESCRIPTION		OMEGA DEPOSITOR			02	02/11/20	RO	INITIAL RELEASE
PROJECT		OMEGA_MK3B			03			
TITLE		SAFETY CIRCUIT			04			
INSTALLATION		PANEL			05			
ELECTRICAL SPECIFICATIONS		240VAC 1PH+H+E 50HZ			06			
ELECTRICALLY APPROVED BY		ANGELA THOMAS			07			
DRAWING NUMBER		079E25-00060			08			
PAGE		2			09			
OF		15			10			
REV		A			11			
END								

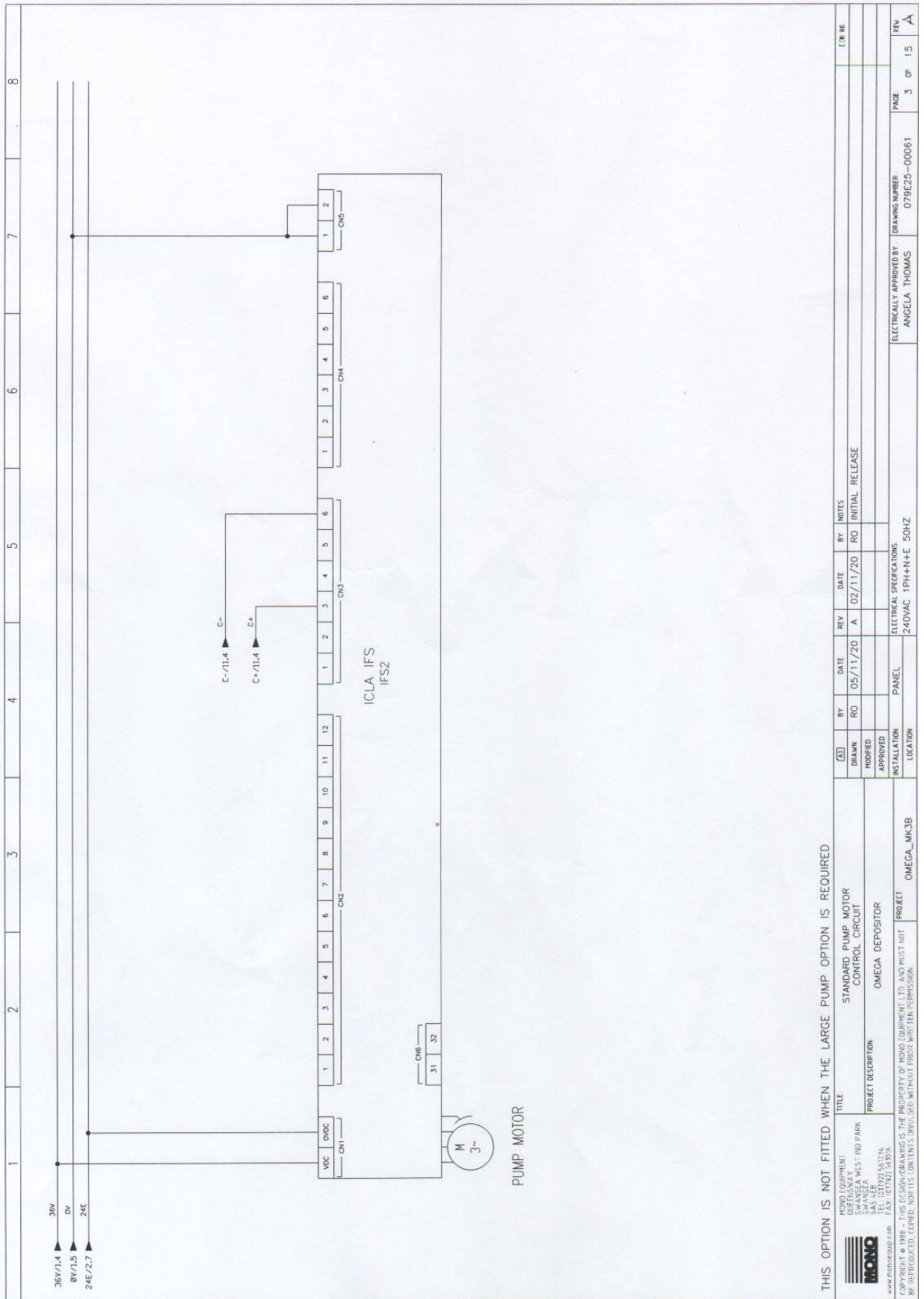

THIS OPTION IS NOT FITTED WHEN THE LARGE PUMP OPTION IS REQUIRED

MONO EQUIPMENT 1000 WEST 12ND PARK SWANSEA TEL: (01792) 567234 FAX: (01792) 567076 www.monopump.com		TITLE STANDARD PUMP MOTOR CONTROL CIRCUIT		DATE 05/11/20		REV A		BY RO		DATE 02/11/20		REV RO		NOTES INITIAL RELEASE		EPR No.	
PROJECT DESCRIPTION OMEGA DEPOSITOR		PROJECT OMEGA_MK3B		INSTALLATION LOCATION		ELECTRICAL SPECIFICATIONS 240VAC 1PH+N+E 50HZ		ELECTRICALLY APPROVED BY ANGELA THOMAS		DRAWING NUMBER 079E25-00061		PAGE 3 OF 15		REV A			

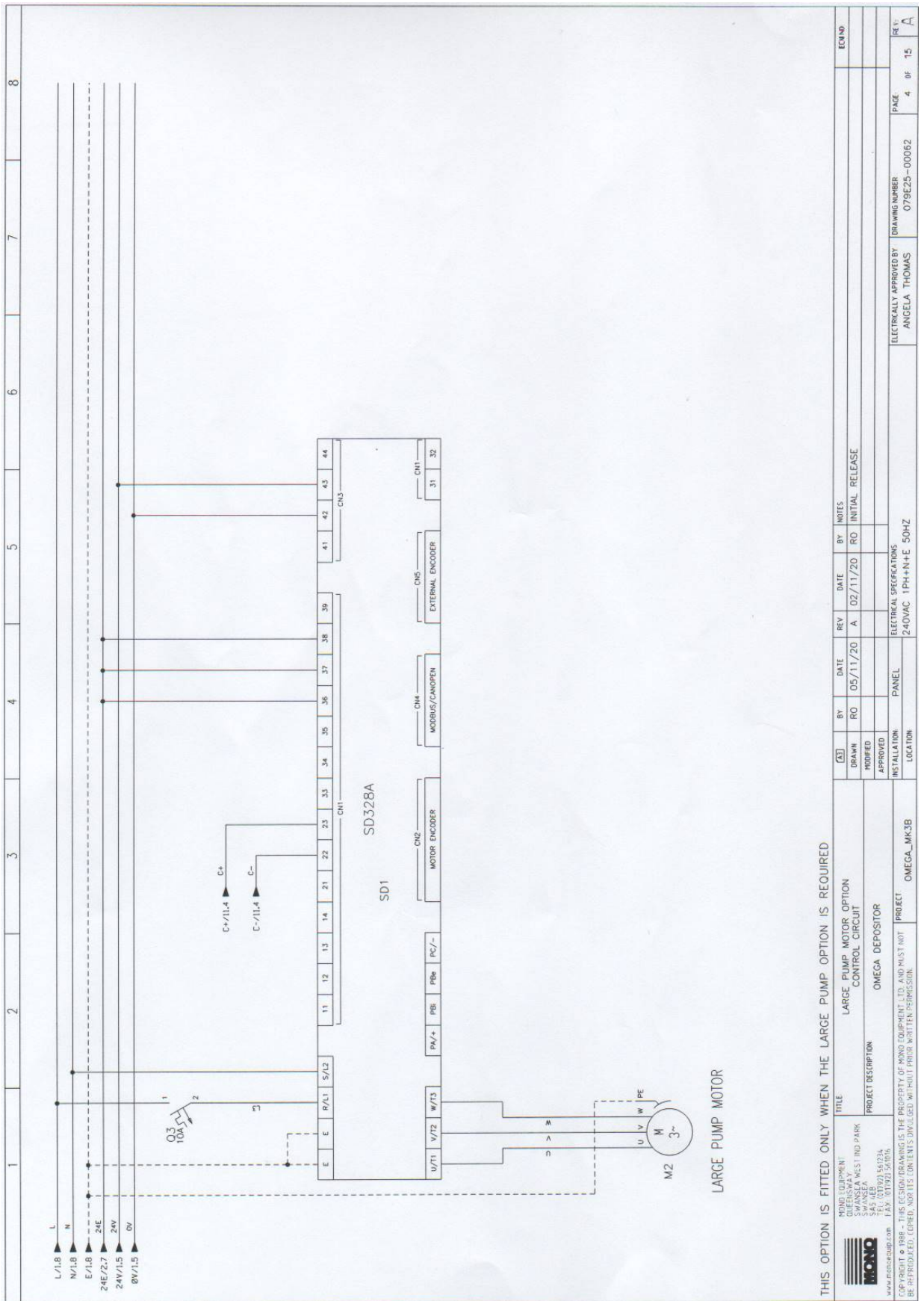

THIS OPTION IS FITTED ONLY WHEN THE LARGE PUMP OPTION IS REQUIRED

MIND EQUIPMENT SWANSEA INDUSTRIAL PARK SWANSEA TEL: (01792) 565734 FAX: (01792) 565676 www.mind-equip.com		TITLE LARGE PUMP MOTOR OPTION CONTROL CIRCUIT		DATE 05/11/20		REV A		BY RO		DATE 02/11/20		REV A		BY RO		DATE 02/11/20		REV A		BY RO		DATE 02/11/20		REV A	
PROJECT DESCRIPTION OMEGA DEPOSITOR		PROJECT OMEGA_MK3B		ELECTRICAL SPECIFICATIONS 240VAC 1PH+N+E 50HZ		INSTALLATION LOCATION		ELECTRICALLY APPROVED BY ANGELA THOMAS		DRAWING NUMBER 079E25-00062		PAGE 4 of 15		REV A		ECONO									

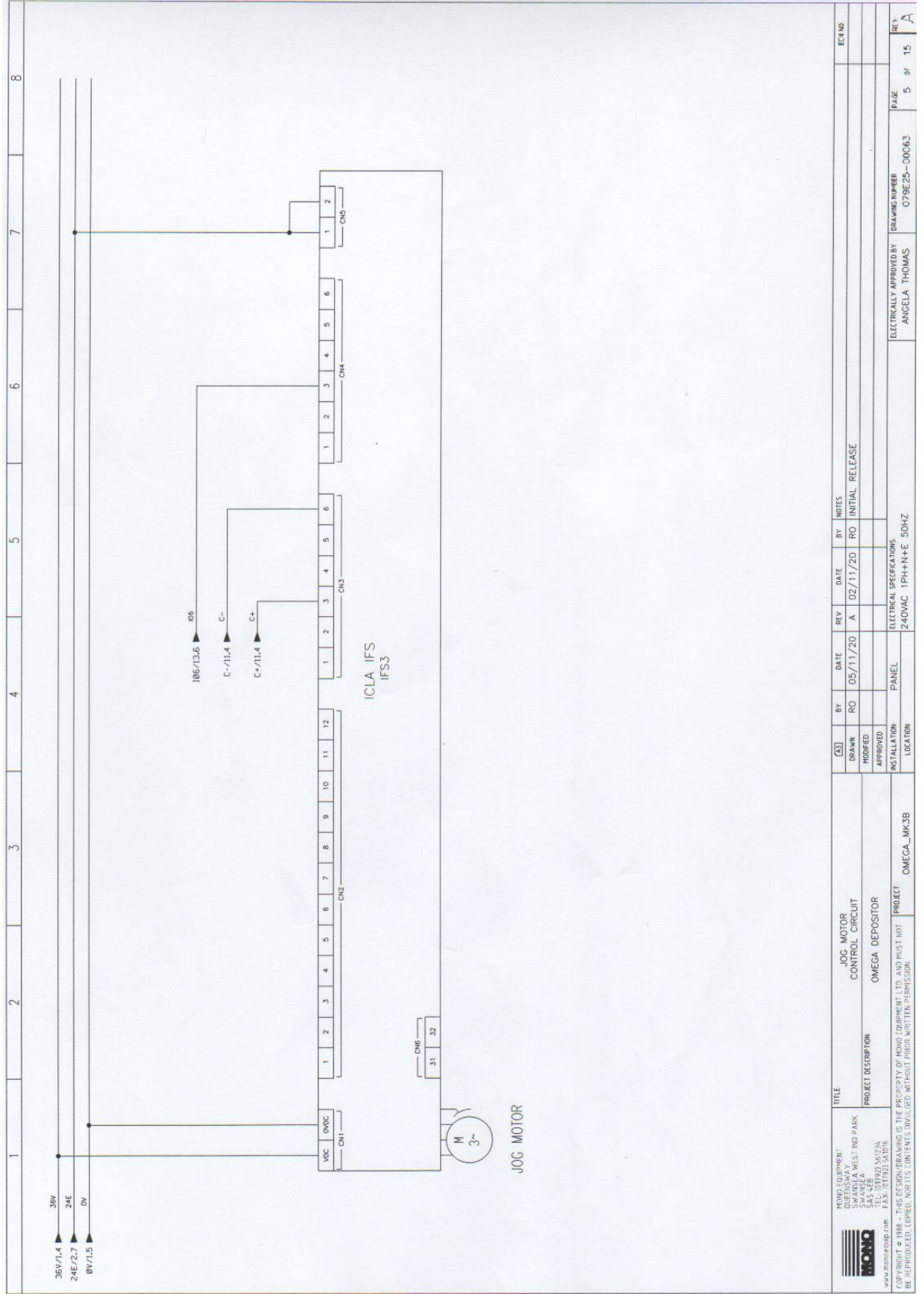

MIND EQUIPMENT SWANSEA, WALES, UK TEL: (01792) 559234 FAX: (01792) 567606 www.mind-equip.com		PROJECT DESCRIPTION OMEGA DEPOSITOR		PROJECT OMEGA_MK3B		ELECTRICALLY APPROVED BY ANGELA THOMAS		DRAWING NUMBER 079E25-00363		PAGE 5 of 15		REV A	
TITLE JOG MOTOR CONTROL CIRCUIT		PROJECT LOCATION OMEGA_MK3B		ELECTRICAL SPECIFICATIONS 240VAC 1PH+N+E 50HZ		ELECTRICAL SPECIFICATIONS		ELECTRICAL SPECIFICATIONS		ELECTRICAL SPECIFICATIONS		ELECTRICAL SPECIFICATIONS	
BY RO		DATE 05/11/20		REV A		DATE 02/11/20		BY RO		NOTES INITIAL RELEASE		EQUIV NO	
DRAWN		MODIFIED		APPROVED		INSTALLATION		LOCATION		PANEL		EQUIV NO	

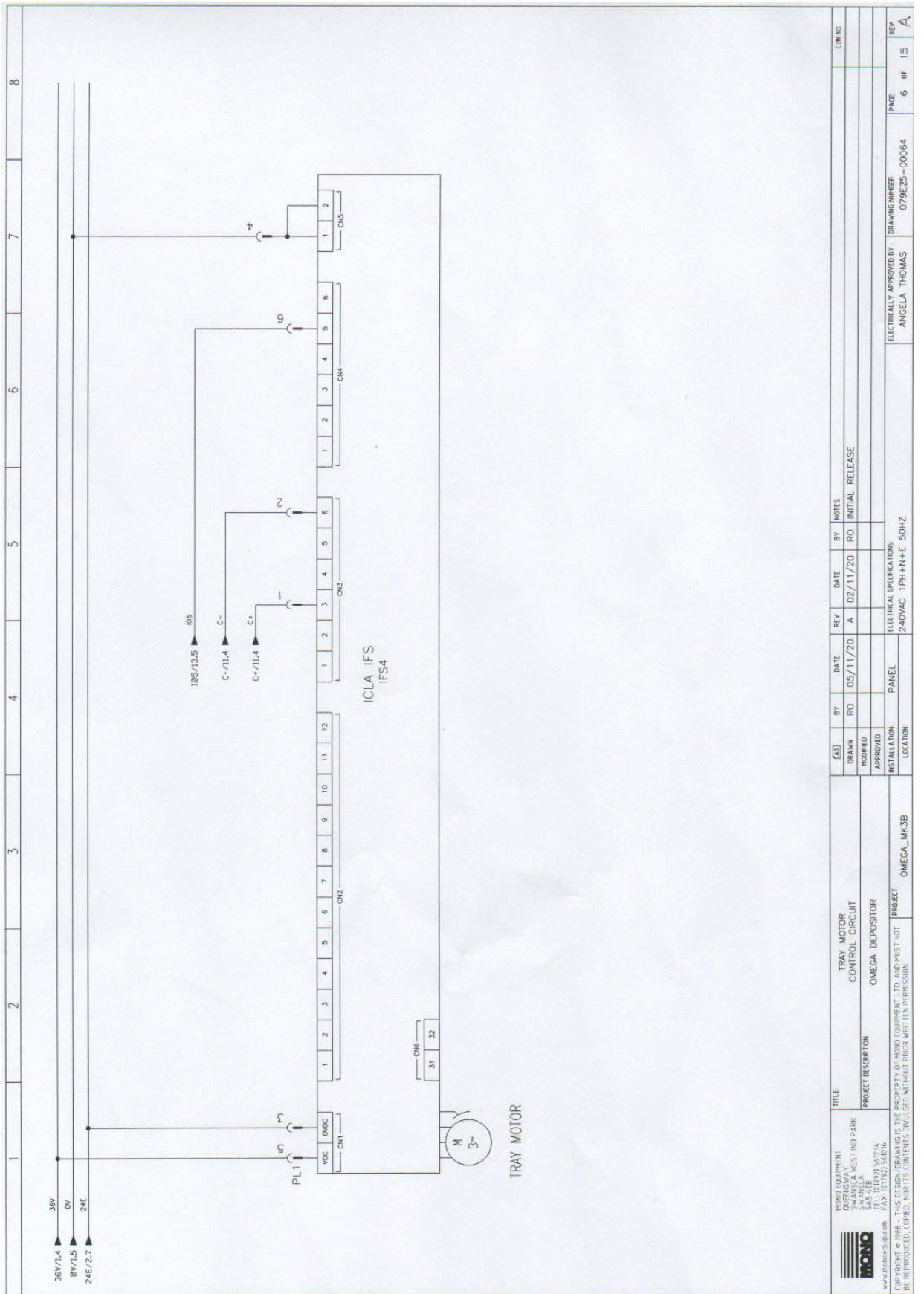

MONO EQUIPMENT 30 WANSLEY RD SWANSEA, MASS 01903 TEL: (508) 552-2400 FAX: (508) 552-2400 www.monopump.com		TITLE TRAY MOTOR CONTROL CIRCUIT		BY RO		DATE 05/11/20		REV A		BY RO		DATE 02/11/20		NOTES INITIAL RELEASE		E.M.N.D.	
PROJECT DESCRIPTION OMEGA DEPOSITOR		PROJECT OMEGA_MK3B		INSTALLATION LOCATION		ELECTRICAL SPECIFICATIONS 240VAC 1PH+N+E 50HZ		ELECTRICALLY APPROVED BY ANGELA THOMAS		DRAWING NUMBER 079E25-00064		PAGE 6 of 15		REV A			

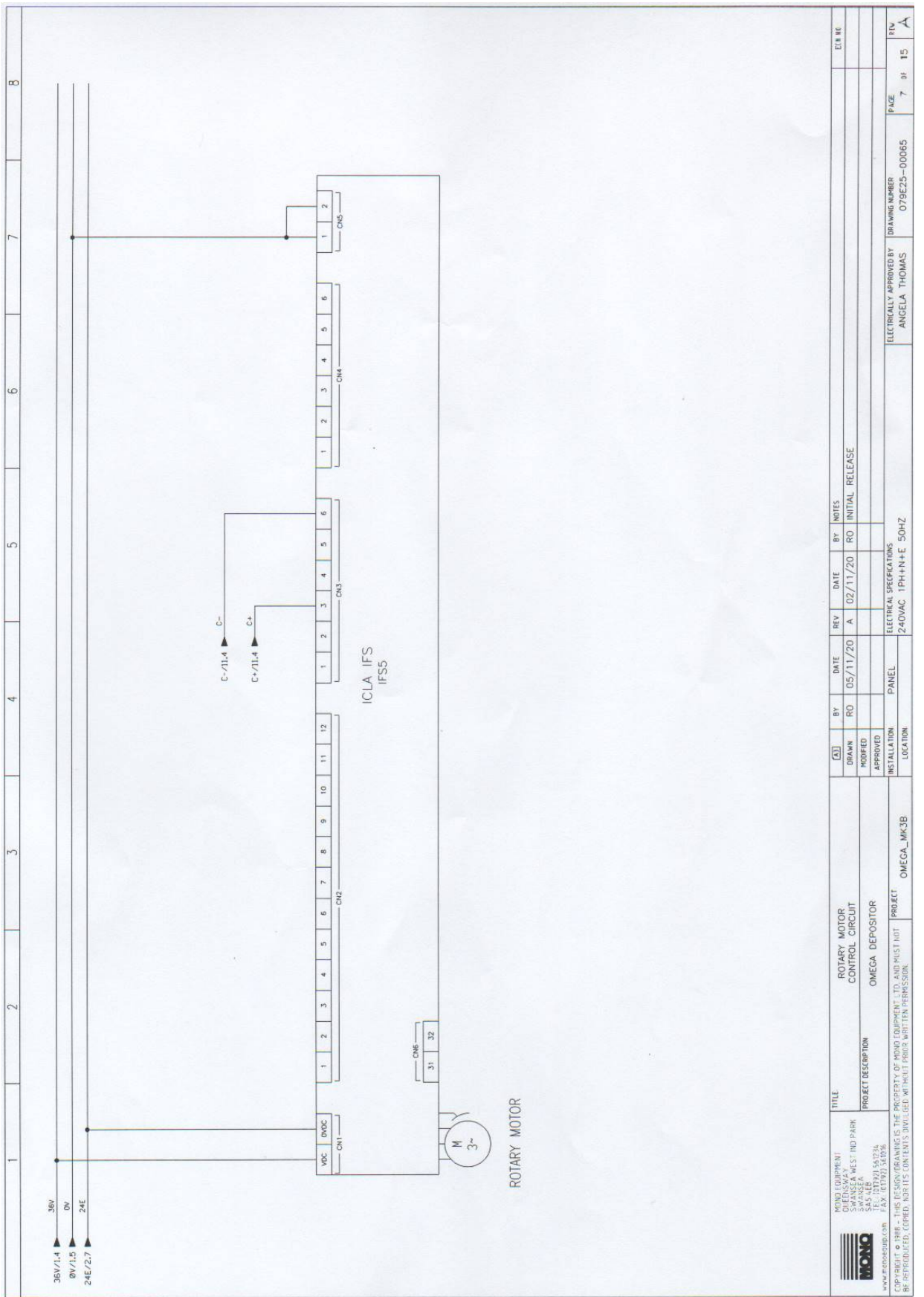

MONO EQUIPMENT SWANSEA WEST IND PARK SWANSEA TEL: (01792) 541234 FAX: (01792) 541236 www.monoequip.com	TITLE	PROJECT DESCRIPTION	PROJECT	OMEGA_MK3B	ELECTRICALLY APPROVED BY ANGELA THOMAS	DRAWING NUMBER 079E25-00065	PAGE 7 of 15	REV A
	PROJECT	OMEGA DEPOSITOR	PROJECT	OMEGA_MK3B				
www.monoequip.com COPYRIGHT © 1986 - THIS DESIGN DRAWING IS THE PROPERTY OF MONO EQUIPMENT LTD. AND MUST NOT BE REPRODUCED, COPIED, NOR ITS CONTENTS, DISCLOSED, WITHOUT WRITTEN PERMISSION.	BY	DATE	REV	DATE	BY	NOTES	DATE	
	RO	05/11/20	A	02/11/20	RO	INITIAL RELEASE	DATE	
	INSTALLATION	PANEL	ELECTRICAL SPECIFICATIONS	ELECTRICAL SPECIFICATIONS			DATE	
	LOCATION	240VAC 1PH+N+E 50HZ					DATE	

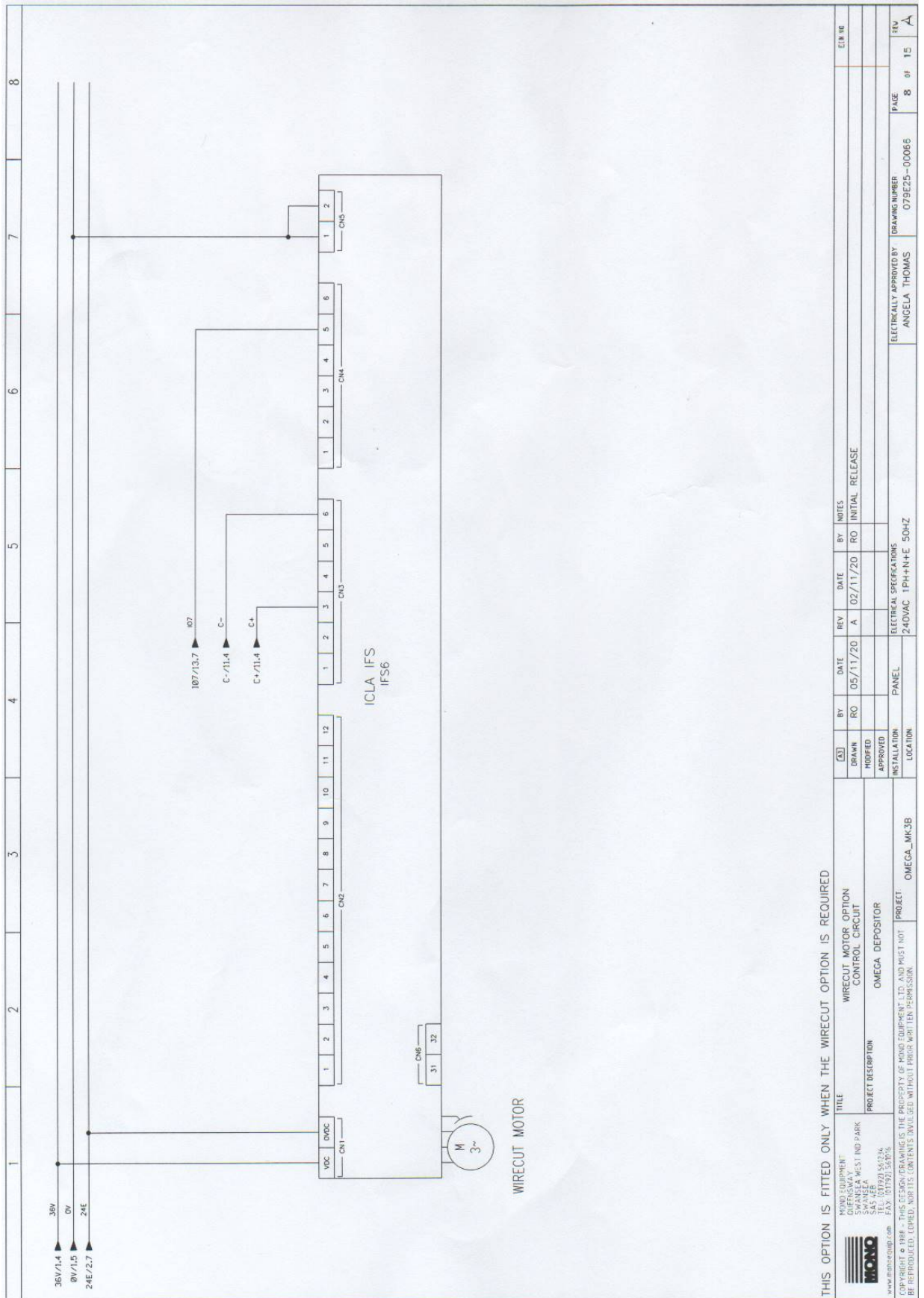

THIS OPTION IS FITTED ONLY WHEN THE WIRECUT OPTION IS REQUIRED

MONO EQUIPMENT SWANSEA WEST IND PARK SWANSEA TEL: 01792 567224 FAX: 01792 567076 www.monoequip.com		TITLE WIRECUT MOTOR OPTION CONTROL CIRCUIT		BY DATE REV DATE BY NOTES RO 05/11/20 A 02/11/20 RO INITIAL RELEASE		EIM NO	
PROJECT DESCRIPTION OMEGA DEPOSITOR		PROJECT OMEGA_MK3B		ELECTRICALLY APPROVED BY ANGELA THOMAS		PAGE 8 of 15	
INSTALLATION LOCATION OMEGA_MK3B		ELECTRICAL SPECIFICATIONS 240VAC 1PH+N+E 50HZ		DRAWING NUMBER 079E25-00066		REV A	

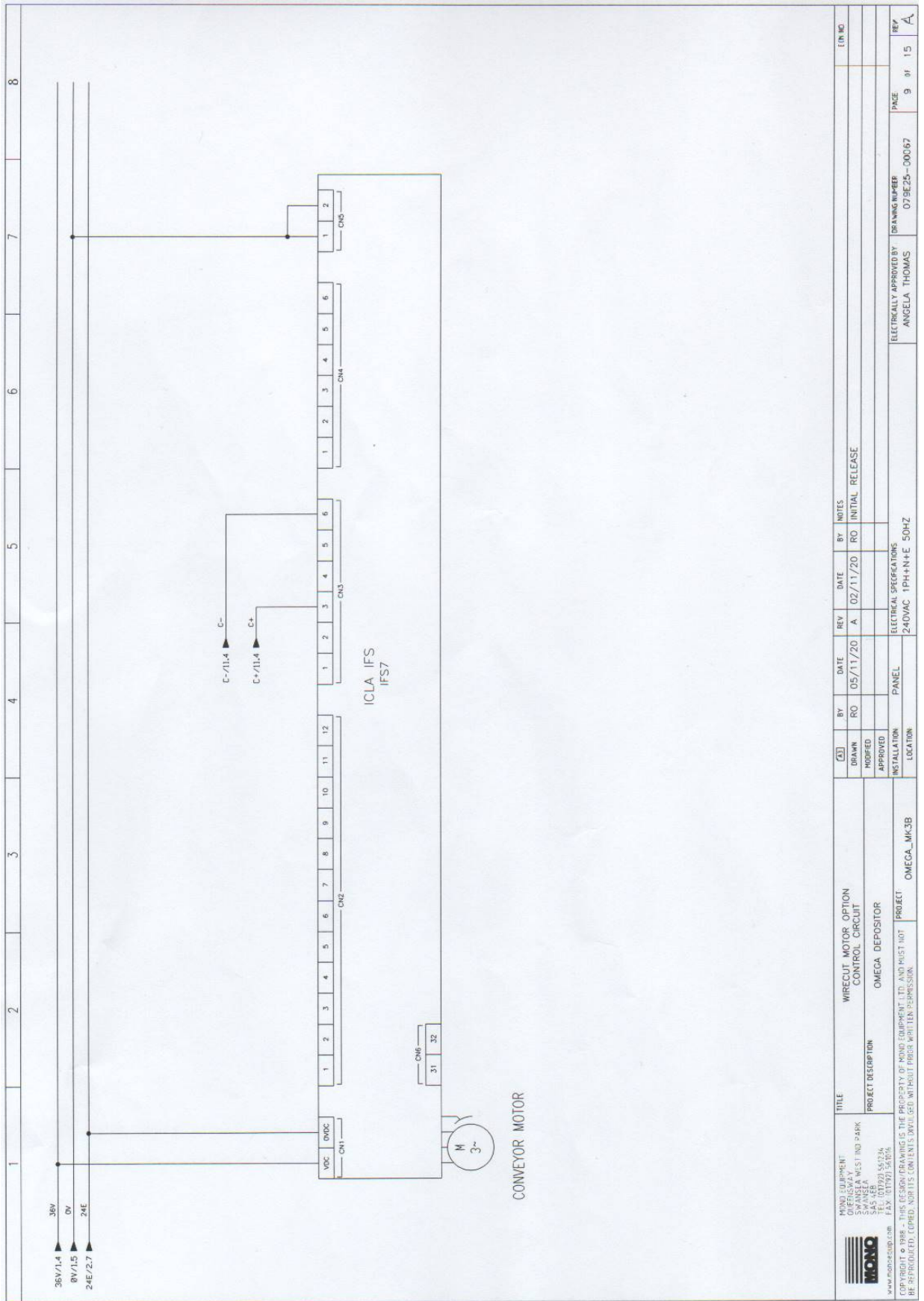

		MONO EQUIPMENT SWANSEA WEST IND 24PK SWANSEA SWANSEA TEL: (01922) 565724 FAX: (01922) 565076 www.monoequip.com		TITLE WIRECUT MOTOR OPTION CONTROL CIRCUIT		PROJECT DESCRIPTION OMEGA DEPOSITOR		PROJECT LOCATION OMEGA_MK3B		(S) BY DATE REV DATE BY NOTES DRAWN RO 05/11/20 A 02/11/20 RO INITIAL RELEASE		ELECTRICALLY APPROVED BY ANGELA THOMAS		DRAWING NUMBER 072E25-00067		PAGE 9 of 15		REV A	
--	--	---	--	--	--	--	--	--------------------------------	--	--	--	---	--	--------------------------------	--	-----------------	--	----------	--

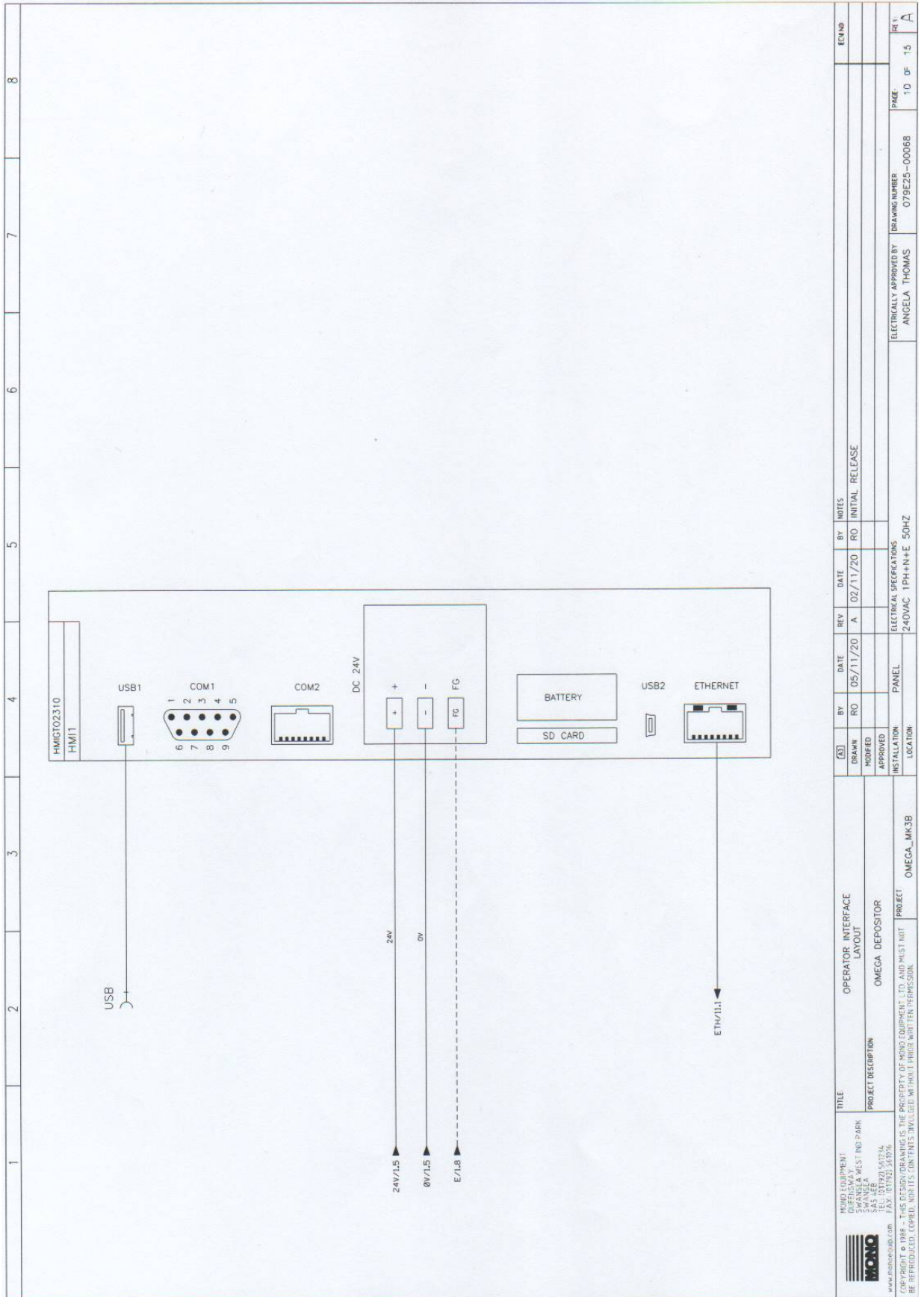

DATE	REV	BY	DATE	REV	BY	NOTES	ECN NO
05/11/20	A	RO	02/11/20	RO	RO	INITIAL RELEASE	
ELECTRICAL SPECIFICATIONS							
240VAC 1PH+N+E 50HZ							
ELECTRICALLY APPROVED BY							
ANGELA THOMAS							
DRAWING NUMBER							
079E25-00068							
PAGE							
10 OF 15							
REV							
A							

DATE	REV	BY	DATE	REV	BY	NOTES	ECN NO
05/11/20	A	RO	02/11/20	RO	RO	INITIAL RELEASE	
ELECTRICAL SPECIFICATIONS							
240VAC 1PH+N+E 50HZ							
ELECTRICALLY APPROVED BY							
ANGELA THOMAS							
DRAWING NUMBER							
079E25-00068							
PAGE							
10 OF 15							
REV							
A							

DATE	REV	BY	DATE	REV	BY	NOTES	ECN NO
05/11/20	A	RO	02/11/20	RO	RO	INITIAL RELEASE	
ELECTRICAL SPECIFICATIONS							
240VAC 1PH+N+E 50HZ							
ELECTRICALLY APPROVED BY							
ANGELA THOMAS							
DRAWING NUMBER							
079E25-00068							
PAGE							
10 OF 15							
REV							
A							

DATE	REV	BY	DATE	REV	BY	NOTES	ECN NO
05/11/20	A	RO	02/11/20	RO	RO	INITIAL RELEASE	
ELECTRICAL SPECIFICATIONS							
240VAC 1PH+N+E 50HZ							
ELECTRICALLY APPROVED BY							
ANGELA THOMAS							
DRAWING NUMBER							
079E25-00068							
PAGE							
10 OF 15							
REV							
A							

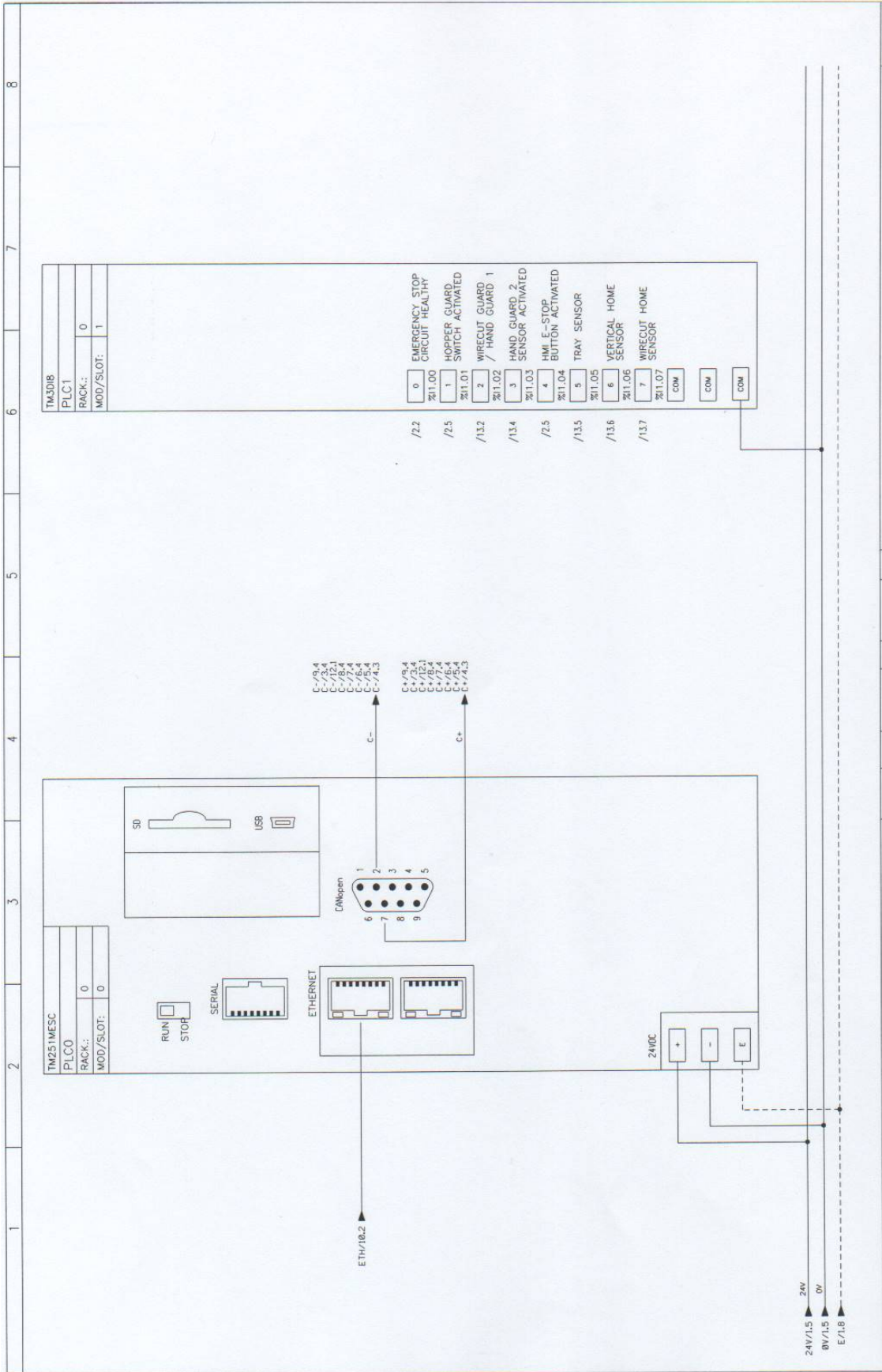

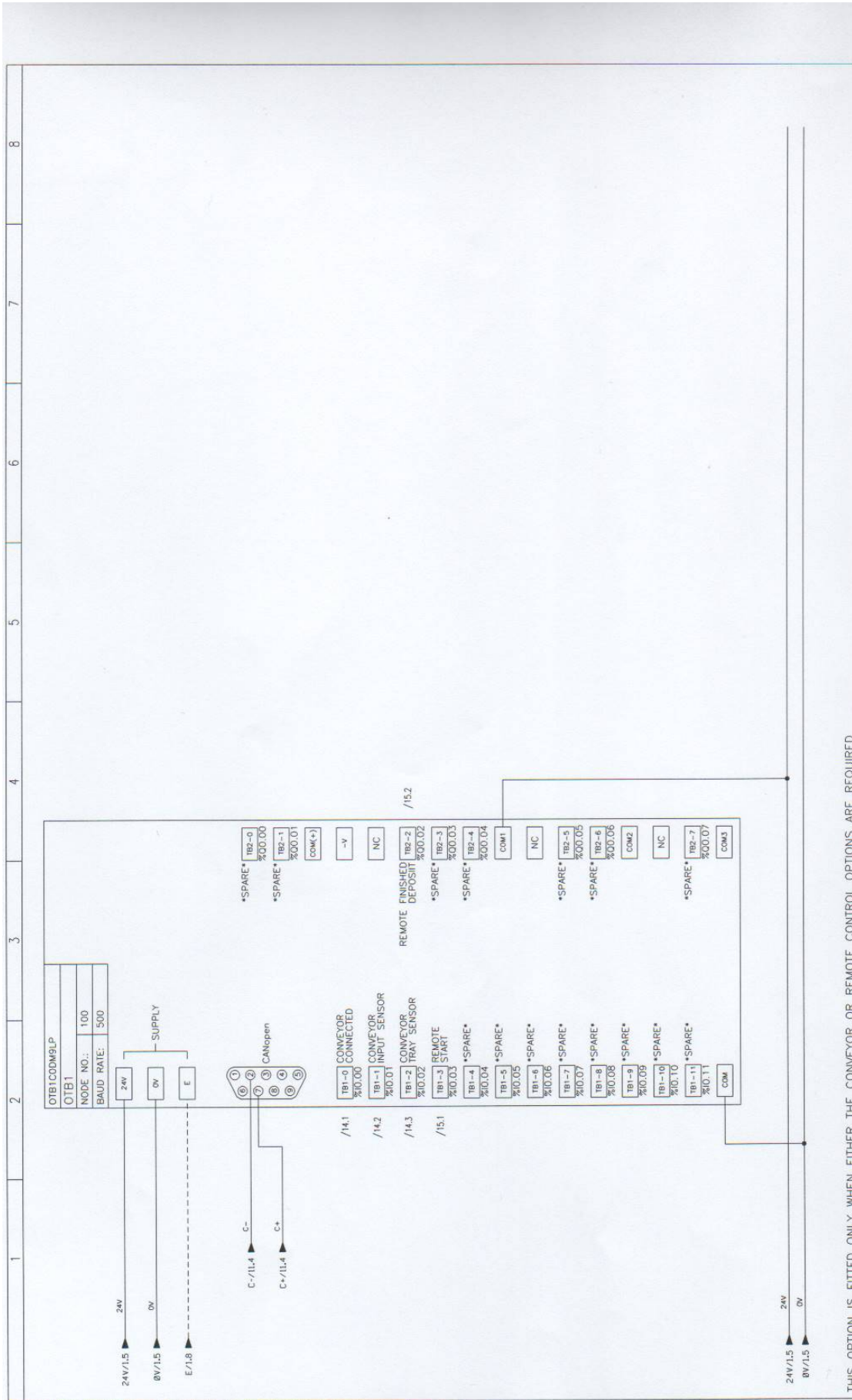

THIS OPTION IS FITTED ONLY WHEN EITHER THE CONVEYOR OR REMOTE CONTROL OPTIONS ARE REQUIRED

MONITOR EQUIPMENT SWANSEA SWANSEA WEST IND PARK TEL: 01792 561234 FAX: 01792 561606 www.monitequip.com		PROJECT DESCRIPTION OMEGA DEPOSITOR		PROJECT OMEGA_MK3B		ELECTRICAL SPECIFICATIONS 240VAC 1PH+N+E 50HZ		ELECTRICALLY APPROVED BY ANGELA THOMAS		DRAWING NUMBER 079E25-00070		PAGE 12 OF 15		REV A	
TITLE	REMOTE INPUT/OUTPUT MODULE OPTION LAYOUT	BY	RO	DATE	05/11/20	REV	A	DATE	02/11/20	BY	RO	NOTES	INITIAL RELEASE	TCNO	
<p>OMEGA DEPOSITOR</p> <p>INSTALLATION PANEL</p> <p>LOCATION</p>															

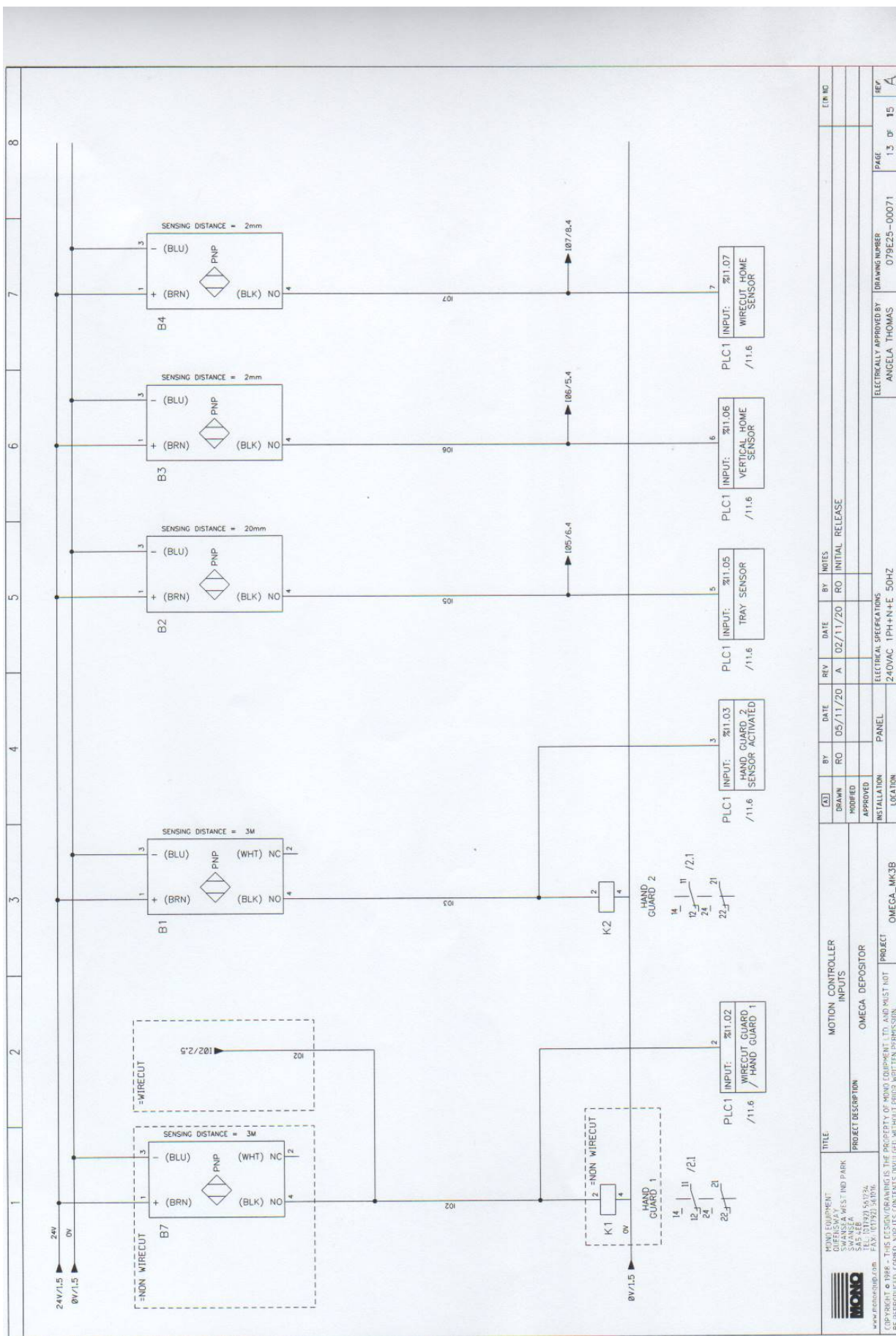

REV	DATE	BY	NOTES
A	02/11/20	RO	INITIAL RELEASE

DATE	BY	DESCRIPTION
05/11/20	RO	DRAWN
		APPROVED
		INSTALLATION

LOCATION	PANEL	ELECTRICAL SPECIFICATIONS
OMEGA_LM3B		240VAC, 1PH+N+E, 50HZ

REF	DATE	APPROVED BY	DRAWING NUMBER	PAGE
A	13 OF 15	ANGELA THOMAS	079E25-00071	

TITLE	PROJECT DESCRIPTION	PROJECT
MOTION CONTROLLER INPUTS	OMEGA DEPOSITOR	PROJECT

OMP/COMP/REP	OMEGA PLUS	OMEGA PLUS	OMEGA PLUS
www.omegadepositor.com	12, 14, 18, 20, 21, 22	12, 14, 18, 20, 21, 22	12, 14, 18, 20, 21, 22

COPYRIGHT © 1998 - THIS DESIGN/DRAWING IS THE PROPERTY OF OMEGA EQUIPMENT LTD. AND MUST NOT BE REPRODUCED, COPIED, NOR ITS CONTENTS DISCLOSED WITHOUT PRIOR WRITTEN PERMISSION.

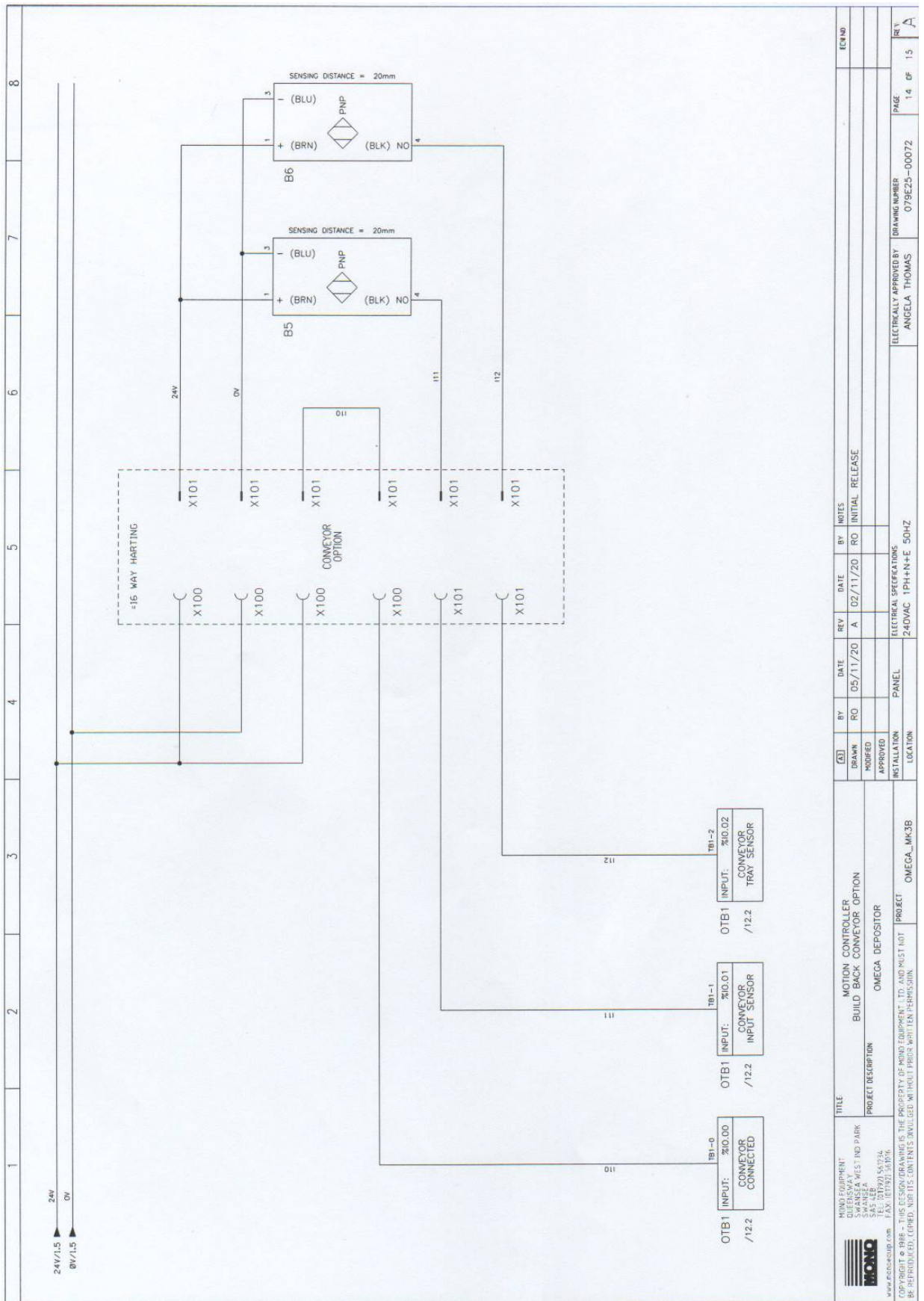

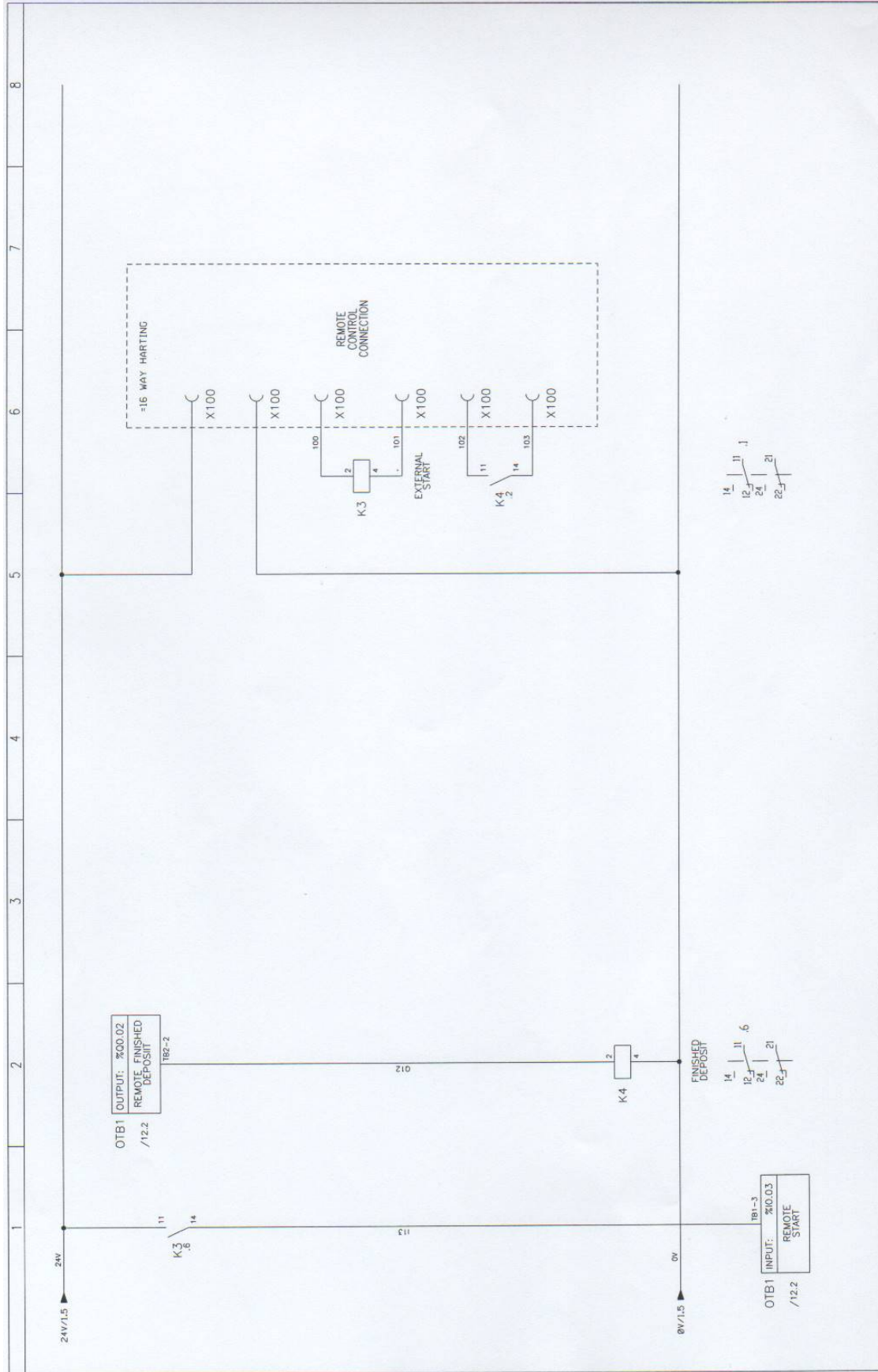

NO.	BY	DATE	REV	DATE	BY	NOTES
1	RO	05/11/20	A	02/11/20	RO	INITIAL RELEASE
ELECTRICAL SPECIFICATIONS						
240VAC 1PH+N+E 50HZ						
ELECTRICALLY APPROVED BY						
ANGELA THOMAS						
DRAWING NUMBER						
079E25-00073						
PAGE						
15 OF 15						
REV						
A						

OMEGA TLCC/LMC TO M251 CONVERSION KITS

(Converts older machines to latest specification controller and screen)

M079-KSE009 OMEGA DEPOSITOR TLCC TO M251 CONVERSION KIT

Comprises of :

- 078-25-00051 CONVERSION BRACKET & FIXINGS (manufactured)
 - M079-KSE006 TLCC TO M251 CONVERSION (HAC Ref: H300-001-0063)
 - H200-004-038 Omega depositor MK3 M251 controller
 - H200-005-011 Omega depositor MK3 HMI
 - H200-007-010 Ethernet cat 6 patch cable 1.5m
 - H200-100-060 Omega TLCC to M251 IO and power loom
 - H200-007-011 Omega TLCC to M251 canopen comms cable.
 - H100-007-012 TM3 expansion module 8 input 24V DC
 - H200-003-073 USB stick blank FAT32
 - TS35 DIN Rail for mounting M251 (TLCC 90mm)
- Also to include instructions - M251 Conversion procedure (TLCC)

M079-KSE007 OMEGA DEPOSITOR LMC (GT) TO M251 CONVERSION KIT

HAC Ref: H300-001-0064

Comprises of :

- H200-004-038 Omega depositor MK3 M251 controller
 - H200-005-011 Omega depositor MK3 HMI
 - H200-007-010 Ethernet cat 6 patch cable 1.5m
 - H200-100-061 Omega LMC to M251 IO and power loom
 - H200-007-012 Omega LMC to M251 canopen comms cable.
 - H100-007-012 TM3 expansion module 8 input 24V DC
 - H200-003-073 USB stick blank FAT32
- TS35 DIN Rail for mounting M251 (LMC 410mm)
- Also to include instructions - M251 Conversion procedure (LMC)

M079-KSE008 OMEGA DEPOSITOR LMC (GTO) TO M251 CONVERSION KIT

HAC Ref: H300-001-0065

Comprises of :

- H200-004-038 Omega depositor MK3 M251 controller
 - H200-003-064 Omega depositor MK3 HMI USB stick 4.3.0.0.A
 - H200-007-010 Ethernet cat 6 patch cable 1.5m
 - H200-100-061 Omega LMC to M251 IO and power loom
 - H200-007-012 Omega LMC to M251 canopen comms cable.
 - H100-007-012 TM3 expansion module 8 input 24V DC
 - H200-003-073 USB stick blank FAT32
- TS35 DIN Rail for mounting M251 (LMC 410mm)
- Also to include instructions - M251 Conversion procedure (LMC)

TLCC to M251 Conversion Procedure



ONLY COMPETENT PERSONS TRAINED IN ELECTRICAL MAINTENANCE SHOULD ATTEMPT TO CARRY OUT THIS PROCEDURE. FAILURE TO OBSERVE SAFE WORKING PRACTICES AND FOLLOW THE INSTRUCTIONS IN THIS PROCEDURE COULD LEAD TO SERIOUS INJURY OR DEATH.

YOU MUST ISOLATE THE POWER SUPPLY BEFORE PROCEEDING.

YOU MUST WAIT FOR AT LEAST 10 MINUTES AFTER ISOLATION OF THE POWER SUPPLY BEFORE WORKING ON THE MACHINE.



REMOVE TLCC MOTION CONTROLLER AND WIRING **A**

Follow the steps below to update the remove the TLCC motion controller and associated wiring :-

1

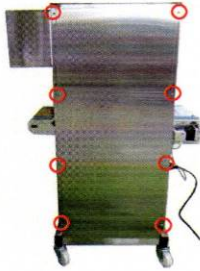

Remove the 8 screws securing the main enclosure cover to gain access to the electrical control panel.

2

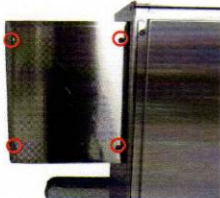

Remove the 4 screws securing the HMI enclosure cover to gain access to the rear of the HMI.

3

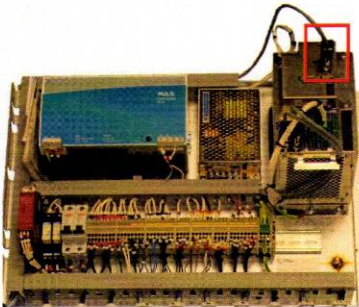

Remove the 'D' connector from the TLCC using a small screwdriver.

4

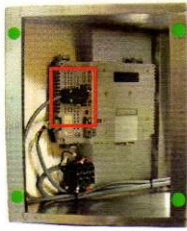

Remove the 'D' connector from the HMI using a small screwdriver.

5

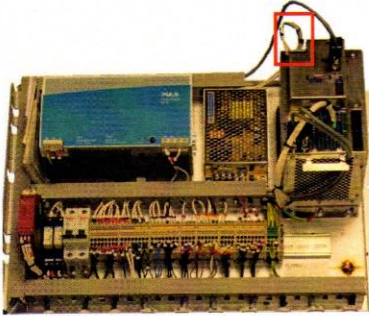

Remove wires to the power supply of the TLCC using a small screwdriver.

6

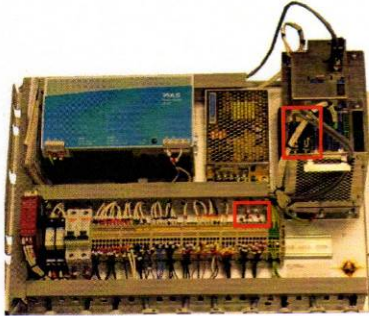

Remove the 2x 'D' connectors from the TLCC using a small screwdriver. Remove the trunking lids. Trace the wires back to the terminals (C1+ / C1- / C2+ / C2-) and remove using a small screwdriver.

7

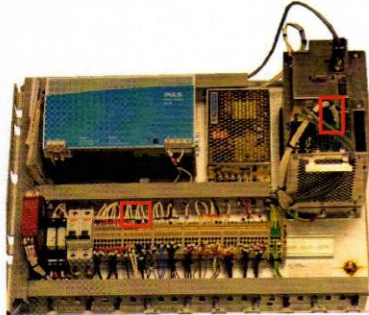

Remove the I/O connector from the TLCC (pull to remove). Trace the wires back to the terminals (I02 to I08) and remove using a small screwdriver. Trace the wire back to the emergency stop relay (I01) and remove with a small screwdriver.

8

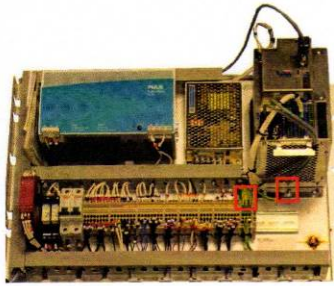

Remove the earth wire from the TLCC using an M8 spanner/socket. Trace the wire back to the terminals and remove using a small screwdriver.

9

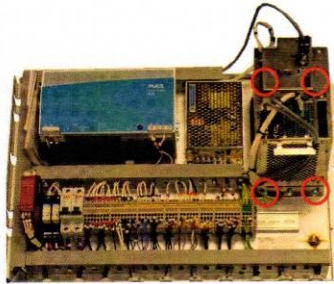

Remove 4x screws using a posidrive screwdriver and remove TLCC motion controller.

INSTALL M251 MOTION CONTROLLER AND WIRING

B

Follow the steps below to install the M251 motion controller and associated wiring :-

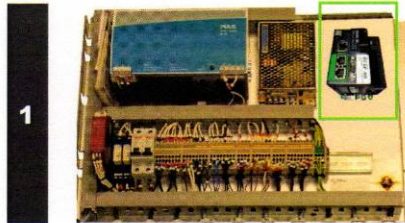

Fix the M251 to the control panel using the fixing kit supplied.



Take the CANOpen comms cable from the conversion kit.

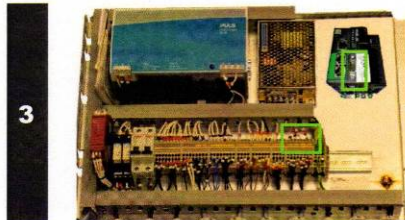

Connect the CAN cable to the port at the top of the M251. Connect the wires at the other end of this cable to the terminals with the corresponding wire numbers (to the same location as the ones previously removed)



Take the IO and power loom from the conversion kit.

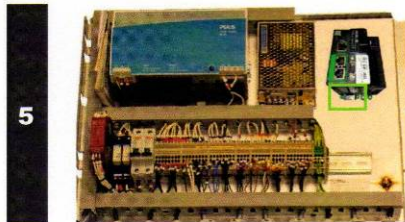

Connect the power supply plug to the M251 (connector at bottom).

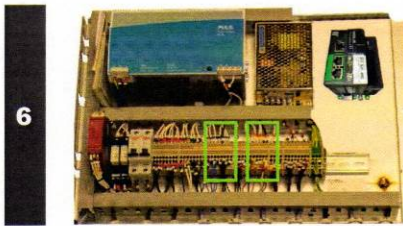

6

Connect the wires at the other end of the power cable to the terminals with the corresponding wire numbers (to the same location as the ones previously removed).

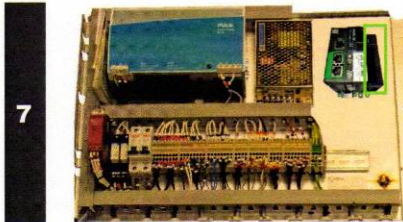

7

Connect the IO cable plug to the M251 expansion module at the right.

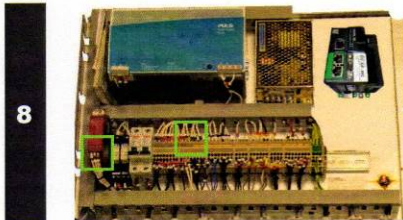

8

Connect the wires at the other end of the IO cable to the terminals with the corresponding wire numbers (to the same location as the ones previously removed) for wires I02 to I08. Connect I01 to the emergency stop relay connection point 14.

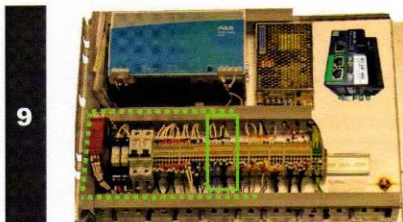

9

Connect the wire marked 0V to the terminals with the corresponding wire numbers. You will have to find a spare/unused terminal on the terminal rails, this may mean routing the cable to the bottom of the terminals.



10

Remove the Modbus cable from the COM1 connector on the HMI by using a small screw driver to loosen the fastening screws and then pulling to release.

This cable will no longer be used and can be completely removed.

1
1



Unplug the HMI power cable and remove the old HMI by loosening and removing the 4x retaining clips with a small posidrive/flat head screwdriver. Then push the HMI out of the cut out.

1
2



Fit the new HMI (HMIGTO3210) using the 4x retaining clips supplied in the box with a small posidrive/flat head screwdriver. Then plug in the power connector.

1
3



Take the HMI cable from the conversion kit.

1
4

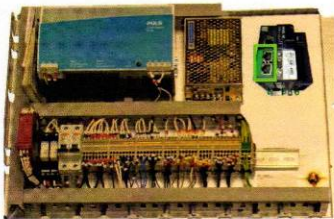

Connect the HMI cable to one of the connectors marked ETHERNET. Ensure that the cable is pushed in firmly, you should hear a "click".

1
5



Connect the HMI cable to the connector marked ETHERNET. Ensure that the cable is pushed in firmly, you should hear a "click".

CONFIGURE MACHINE FOR USE

C

Follow the steps below to configure the machine to recognise the connected hardware and to set factory defaults :-

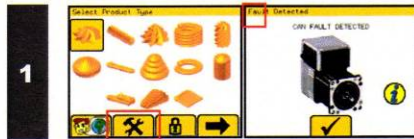

From the Select Product OR Fault page activate the tools password entry (Hidden button at top left of fault page) and type in **01792561234**



Select the options installed on your machine. Press the exit button.

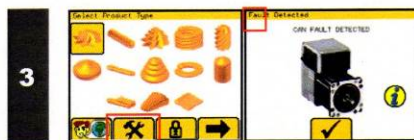

From the Select Product OR Fault page activate the tools password entry (Hidden button at top left of fault page) and type in **01554777460**

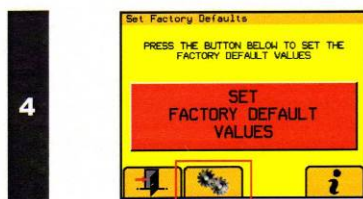

Press the **SET FACTORY DEFAULTS BUTTON**. Then press The **COGS** Button to enter the System Menu.

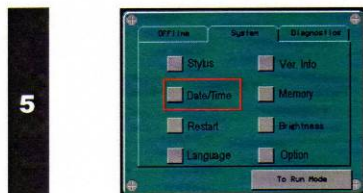

Select the **DATE/TIME** option to enter the date and time setting page.

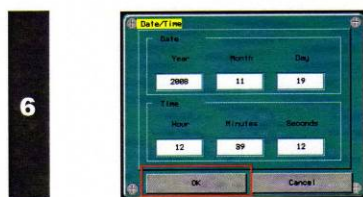

Set the Date and Time to the correct settings and press **OK**.

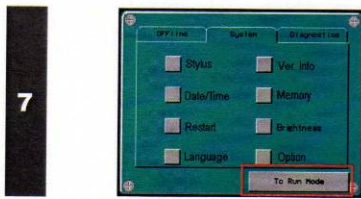

Press the **TO RUN MODE** button to return to the set factory defaults page.

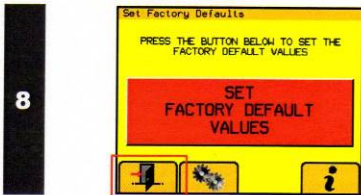

Press the **EXIT** button to return to the main menu.

CYCLE POWER TO THE MACHINE BEFORE CONTINUING

CHECK I/O FUNCTIONALITY **D**

Follow the steps below to verify that the wiring has been completed correctly and that the I/O to the M251 is correct :-



From the Select Product page activate the tools password entry and type in **2808**



Test that **ALL** inputs are working correctly using the diagnostics page.

Inputs are shown as **RED** for **OFF** and **GREEN** for **ON**.

The E-Stop circuit healthy input will switch if any one of the safety devices is switched (e-stop button / hand guard sensor / hopper guard)

To activate the tray / vertical / wirecut sensors you will need to place a metallic object in front of the sensor.

Press the **EXIT** button when all inputs are verified OK.

SET MOTOR PARAMETERS (WHERE REQUIRED)



E



**YOU MUST ISOLATE THE POWER SUPPLY BEFORE PROCEEDING.
YOU MUST WAIT FOR AT LEAST 10 MINUTES AFTER ISOLATION OF THE
POWER SUPPLY BEFORE WORKING ON THE MACHINE.**

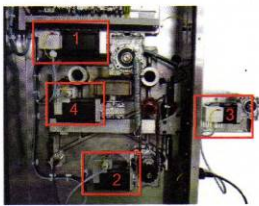

If the machine was previously running with a TLCC software version of v1.0, v1.1, v1.2 or v1.3 then the motor configuration will need to be updated in order for the machine to function :-

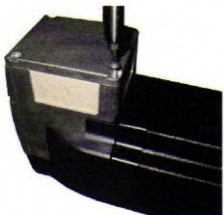
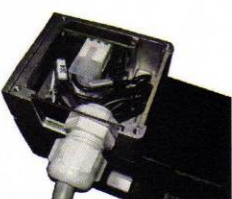
- | | | |
|----------|---|---|
| 1 |  | <p>Identify the motors present in the rear of the machine.</p> <ul style="list-style-type: none">1 – Pump Motor2 – Jog Motor3 – Tray Motor4 – Rotary Motor |
| 2 |  | <p>To access the tray motor remove the cover plate. There are 2 screws on the top and 2 screws on the bottom</p> |
| 3 |  | <p>Locate the motor control box for each motor and remove the 4 screws to gain access (tamper proof screws).</p> |
| 4 |  | <p>Remove the motor control box lid.</p> |

5



Slide the cable gland plate from the motor housing to gain access to the connectors.

6

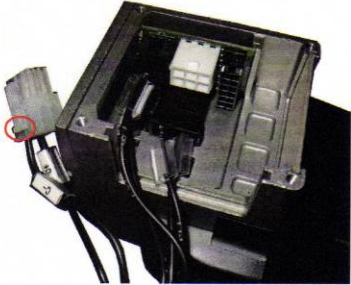

Carefully remove the CAN connector, press the locking pin to release and pull to remove.

7

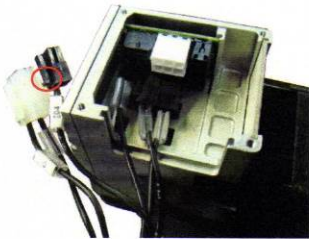

Carefully remove the I/O connector, press the locking pin to release and pull to remove.

8

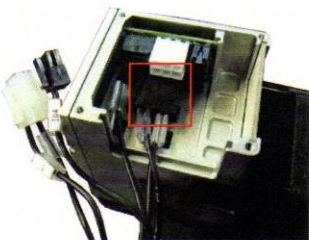

Carefully remove the POWER connector, pull to remove (long nosed pliers can be used).

9

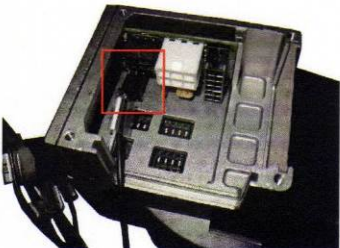

Do **NOT** remove the STOP connector, this cable can be moved out of the way to gain access to the switches.

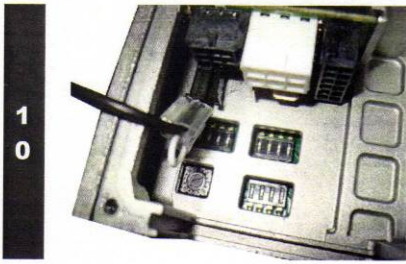

Using a small screwdriver adjust the settings of the switches and rotary dial as per the motor configurations below.

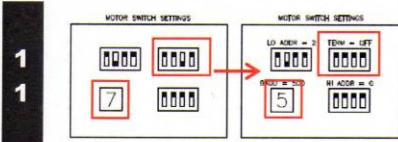

Pump Motor (Standard)
Set the rotary dial to 5 and the DIP switches to the settings shown.

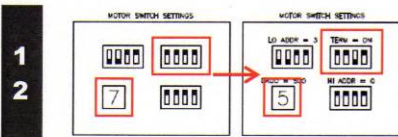

Jog Motor
Set the rotary dial to 5 and the DIP switches to the settings shown.

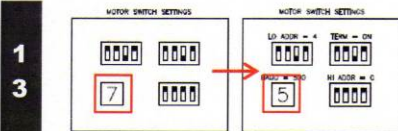

Tray Motor
Set the rotary dial to 5 (as shown)

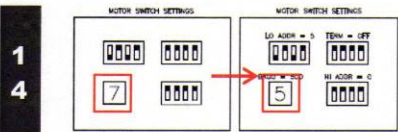

Rotary Motor
Set the rotary dial to 5 (as shown)

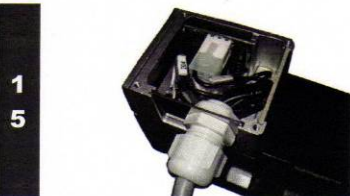

Re-fit all the motor wiring connectors (in reverse order to removal) and fit the gland plate in place.

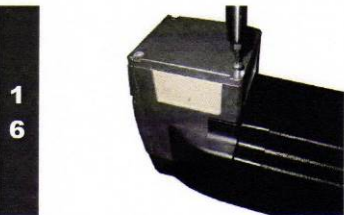

Re-fit the motor control box lid for each motor (ensure that the earth cable is connected).

LMC20 to M251 Conversion Procedure



ONLY COMPETENT PERSONS TRAINED IN ELECTRICAL MAINTENANCE SHOULD ATTEMPT TO CARRY OUT THIS PROCEDURE. FAILURE TO OBSERVE SAFE WORKING PRACTICES AND FOLLOW THE INSTRUCTIONS IN THIS PROCEDURE COULD LEAD TO SERIOUS INJURY OR DEATH.

YOU MUST ISOLATE THE POWER SUPPLY BEFORE PROCEEDING.

YOU MUST WAIT FOR AT LEAST 10 MINUTES AFTER ISOLATION OF THE POWER SUPPLY BEFORE WORKING ON THE MACHINE.



REMOVE LMC20 MOTION CONTROLLER AND WIRING

A

Follow the steps below to update the remove the LMC20 motion controller and associated wiring :-

1

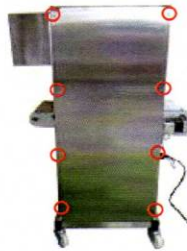

Remove the 8 screws securing the main enclosure cover to gain access to the electrical control panel.

2



Remove the 4 screws securing the main enclosure lid (2 on each side) using 1 4mm allen key and 10mm spanner/socket to gain access to the electrical control panel. To remove the lid lift the lid at the front and slide to the rear then lift to remove.

3

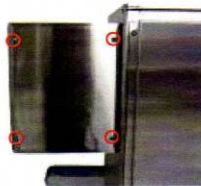

Remove the 4 screws securing the HMI enclosure cover to gain access to the rear of the HMI.

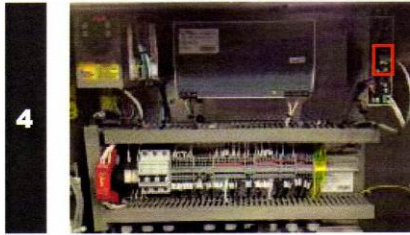

4

Remove the Modbus cable from the Modbus connector on the LMC20 by pressing the small tab on the connector and pulling.



5

Remove the Modbus cable from the RS485 connector on the HMI by pressing the small tab on the connector and pulling.

This cable will no longer be used and can be completely removed.



6

Remove the wires to the power supply of the LMC20 by pulling the green connector. Remove the trunking lids. Trace the wires back to the terminals (0V / 24V) and remove using a small screwdriver.



7

Remove the 'D' connector from the bottom of the LMC20 by pulling the connector. Trace the wires back to the terminals (C+ / C-) and remove using a small screwdriver.

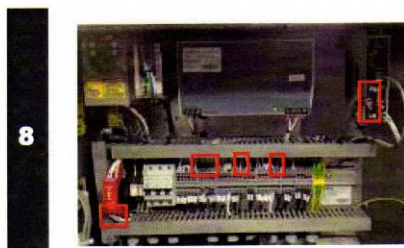

8

Remove the I/O connector from the LMC20 by releasing the retaining clips (top and bottom) and pulling the cable. Trace the wires back to the terminals (I01 to I07, 0V, 24V) and remove using a small screwdriver. Trace the wire back to the emergency stop relay (I00) and remove with a small screwdriver.

9



Unscrew the LMC20 from its mounting bracket using a posidrive screwdriver (you will need to access from the top of the machine). Then pull the LMC20 forward from the top, and then lift to remove from the mounting bracket.

10

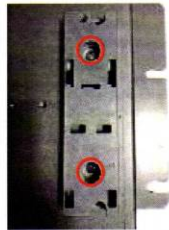

Remove 2x screws using a posidrive screwdriver and remove LMC20 mounting bracket.

INSTALL M251 MOTION CONTROLLER AND WIRING

B

Follow the steps below to install the M251 motion controller and associated wiring :-

- 1**

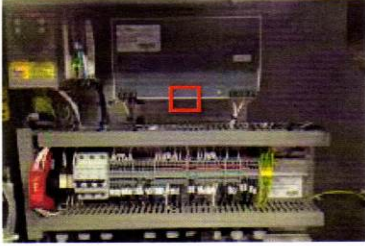

Release the 36 Volt power supply from the DIN rail by using a large flat head screwdriver to pull down on the retaining clip. Lift the power supply off the DIN rail.
- 2**

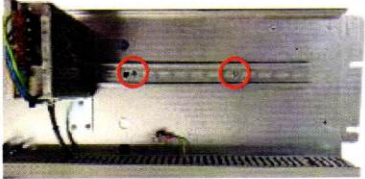

Remove the 2x DIN rail screws using a posidrive screwdriver and remove the DIN rail.
- 3**

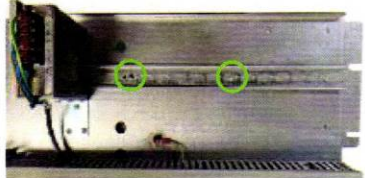

Fix the extended DIN rail in place using the 2x screws.
- 4**

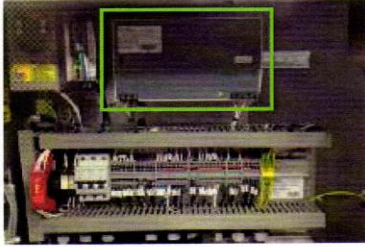

Fix the 36 Volt power supply onto the DIN rail – ensure it is mounted securely.
- 5**

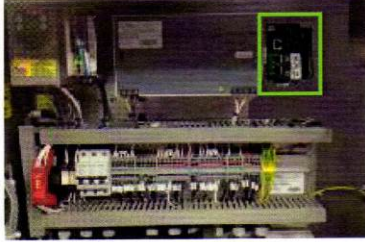

Fix the M251 to the DIN rail – ensure that the 3x retaining clips are in the out position before offering up to the DIN rail, then use a screwdriver to push the 3x retaining clips in – ensure it is mounted securely.
- 6**



Take the CANOpen comms cable from the conversion kit.

7

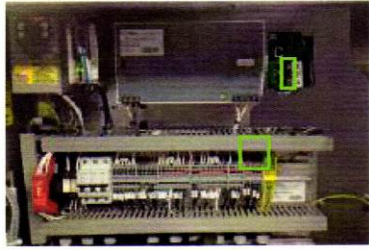

Connect the CAN cable to the port at the top of the M251. Connect the wires at the other end of this cable to the terminals with the corresponding wire numbers (to the same location as the ones previously removed)

8



Take the IO and power loom from the conversion kit.

9

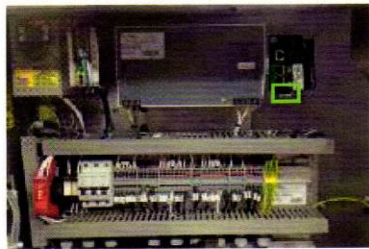

Connect the power supply plug to the M251 (connector at bottom). Note the retaining shroud hinges up to enable the connector to be inserted, insert then hinge the shroud down to fully engage.

10

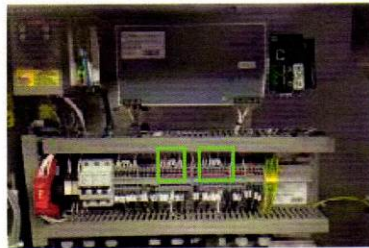

Connect the wires at the other end of the power cable to the terminals with the corresponding wire numbers (to the same location as the ones previously removed).

11

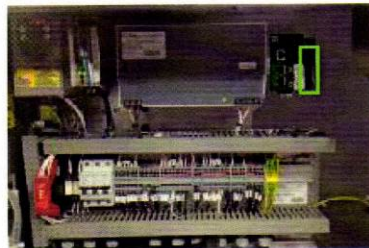

Connect the IO cable plug to the M251 expansion module at the right. Push the connector into the housing – ensure it is fully engaged.

12

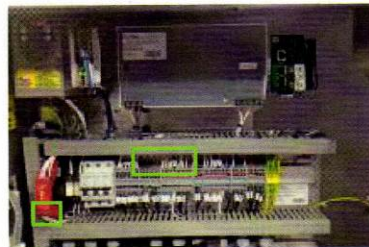

Connect the wires at the other end of the IO cable to the terminals with the corresponding wire numbers (to the same location as the ones previously removed) for wires I01 to I07 and 0V. Connect I00 to the emergency stop relay connection point 14.

IF YOU ALREADY HAVE THE HMIGTO2310 FITTED SKIP TO STEP 15

**1
3**

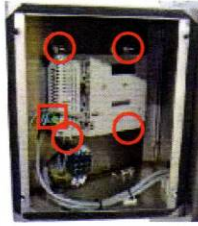

Unplug the HMI power cable and remove the old HMI by loosening and removing the 4x retaining clips with a small posidrive/flat head screwdriver. Then push the HMI out of the cut out.

**1
4**

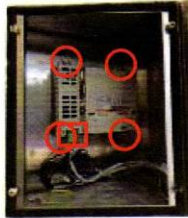

Fit the new HMI (HMIGTO3210) using the 4x retaining clips supplied in the box with a small posidrive/flat head screwdriver. Then plug in the power connector.

**1
5**



Take the HMI cable from the conversion kit.

**1
6**

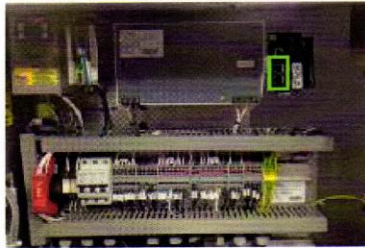

Connect the HMI cable to one of the connectors marked ETHERNET. Ensure that the cable is pushed in firmly, you should hear a "click".

**1
7**



Connect the HMI cable to the connector marked ETHERNET. Ensure that the cable is pushed in firmly, you should hear a "click".

Restore power to the machine. Follow the steps below to configure the machine to recognise the connected hardware and to set factory defaults :-

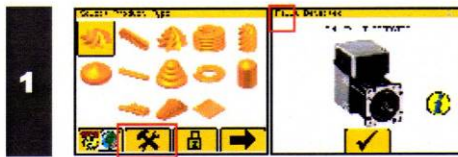

From the Select Product OR Fault page activate the tools password entry (Hidden button at top left of fault page) and type in **01792561234**



Select the options installed on your machine. Press the exit button.

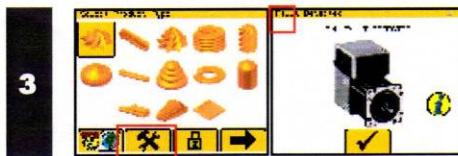

From the Select Product OR Fault page activate the tools password entry (Hidden button at top left of fault page) and type in **01554777460**



Press the **SET FACTORY DEFAULTS BUTTON**. Then press The **COGS** Button to enter the System Menu.

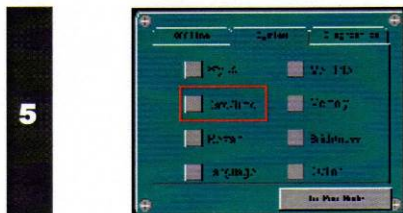

Select the **DATE/TIME** option to enter the date and time setting page.

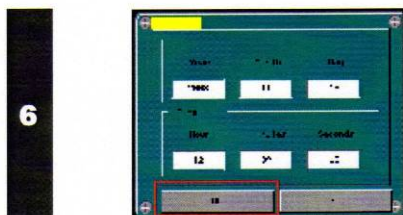

Set the Date and Time to the correct settings and press **OK**.

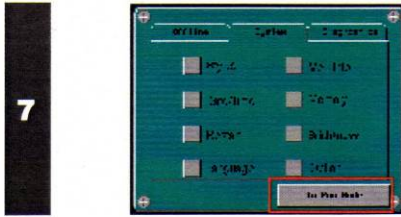

Press the **TO RUN MODE** button to return to the set factory defaults page.



Press the **EXIT** button to return to the main menu.

CYCLE POWER TO THE MACHINE BEFORE CONTINUING

CHECK I/O FUNCTIONALITY **D**

Follow the steps below to verify that the wiring has been completed correctly and that the I/O to the M251 is correct :-

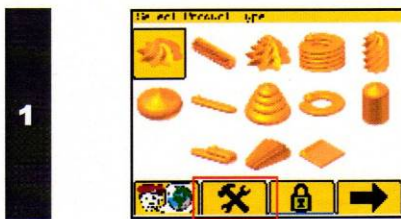

From the Select Product page activate the tools password entry and type in **2808**

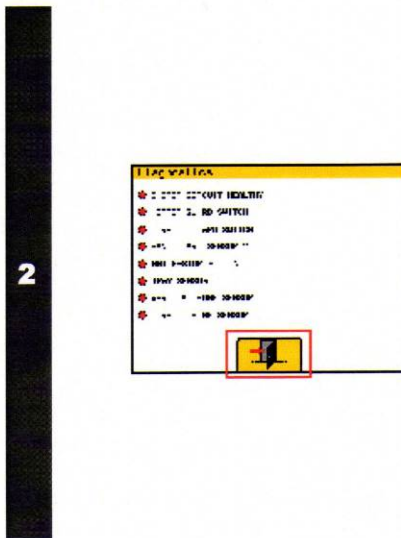

Test that **ALL** inputs are working correctly using the diagnostics page.

Inputs are shown as **RED** for **OFF** and **GREEN** for **ON**.

The E-Stop circuit healthy input will switch if any one of the safety devices is switched (e-stop button / hand guard sensor / hopper guard)

To activate the tray / vertical / wirecut sensors you will need to place a metallic object in front of the sensor.

Press the **EXIT** button when all inputs are verified OK.

Battery Replacement Procedure (M251 Motion Controller)



ONLY COMPETENT PERSONS TRAINED IN ELECTRICAL MAINTENANCE SHOULD ATTEMPT TO CARRY OUT THIS PROCEDURE. FAILURE TO OBSERVE SAFE WORKING PRACTICES AND FOLLOW THE INSTRUCTIONS IN THIS PROCEDURE COULD LEAD TO SERIOUS INJURY OR DEATH.

YOU MUST ISOLATE THE POWER SUPPLY BEFORE PROCEEDING.

YOU MUST WAIT FOR AT LEAST 10 MINUTES AFTER ISOLATION OF THE POWER SUPPLY BEFORE WORKING ON THE MACHINE.



Real Time Clock (RTC)

Overview

The M251 Logic Controller includes an RTC to provide system date and time information, and to support related functions requiring a real-time clock. To continue keeping time when power is off, a non-rechargeable battery is required (see reference below). A battery LED on the front panel of the controller indicates if the battery is depleted or absent.

This table shows how RTC drift is managed:

RTC Characteristics	Description
RTC drift	Less than 60 seconds per month without any user calibration at 25 °C (77 °F)

Battery

The controller has one battery.

In the event of a power interruption, the backup battery maintains the RTC for the controller.

This table shows the characteristics of the battery:

Characteristics	Description
Use	In the event of a transient power outage, the battery powers the RTC and user data.
Backup life	At least 2 years at 25 °C max (77 °F). At higher temperatures, the time is reduced.
Battery monitoring	Yes
Replaceable	Yes
Controller battery type	Lithium carbon monofluoride, type Panasonic BR2032

Installing and Replacing the Battery

While lithium batteries are preferred due to their slow discharge and long life, they can present hazards to personnel, equipment and the environment and must be handled properly.

DANGER

EXPLOSION, FIRE, OR CHEMICAL BURNS

- Replace with identical battery type.
- Follow all the instructions of the battery manufacturer.
- Remove all replaceable batteries before discarding unit.
- Recycle or properly dispose of used batteries.
- Protect battery from any potential short-circuit.
- Do not recharge, disassemble, heat above 100 °C (212 °F), or incinerate.
- Use your hands or insulated tools to remove or replace the battery.
- Maintain proper polarity when inserting and connecting a new battery.

Failure to follow these instructions will result in death or serious injury.

To install or replace the battery, follow these steps:

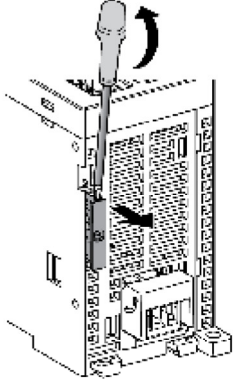
Step	Action
1	Remove power from your controller.
2	Use an insulated screw-driver to pull out the battery holder. 
3	Slide out the battery holder of the controller

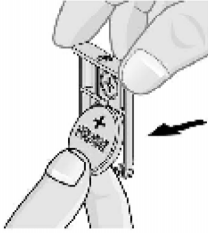
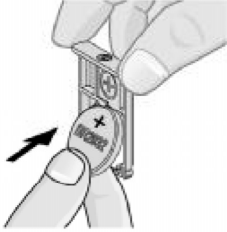
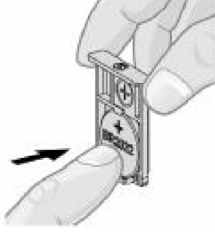
Step	Action
4	Remove the battery from the battery holder. 
5	Insert the new battery into the battery holder in accordance with the polarity markings on the battery. 
6	Replace the battery holder on the controller and verify that the latch clicks into place. 

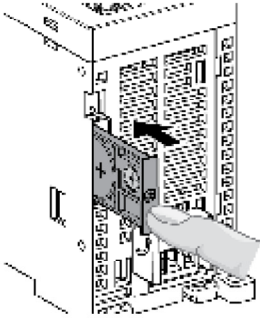
Step	Action
7	Slide in the battery holder of the controller. 
8	Power up your M251 Logic Controller.
9	Set the internal clock. For further details on the internal clock, refer to M251 Logic Controller Programming Guide (see <i>Modicon M251 Logic Controller, Programming Guide</i>).

NOTE: Replacement of the battery in the controllers other than with the type specified in this documentation may present a risk of fire or explosion.

 **WARNING**

IMPROPER BATTERY CAN PROVOKE FIRE OR EXPLOSION

Replace battery only with identical type: Panasonic Type BR2032.

Failure to follow these instructions can result in death, serious injury, or equipment damage.

The equipment mentioned in this manual has CE accreditation.

As it is our policy to improve our machines continuously, we reserve the right to change specifications without prior notice



Omega PLUS



**Omega PLUS
and WIRECUT**



Queensway,
Swansea West Industrial Estate,
Swansea.
SA5 4EB
UK

Tel. +44(0)1792 561234
Spares Tel. +44(0)1792 564039

Email: marketing@monoequip.com
Website: www.monoequip.com

DISPOSAL

Care should be taken when the machine comes to the end of its working life. All parts should be disposed of in the appropriate place, either recycling or other means as the law permits at the time.