

# Artisan Mini Deck Oven

## EN Installation and Operation



### Product Version

- Entry-level professional oven
- Three baking decks
- Racked base unit option

### Product Serial Number

---

---

# Manual Revisions

Revision	Publication Date	Author	Description
A23	06-AUG-2023	CD	First edition.
A25	24-NOV-2024	CD	Updated Declaration of Conformity certificate.
			Updated heating element spares information in Appendix D.
			Added Appendix F (Electrical Drawings).
			Added second QR code to back page.
			Removed "UK Specification" from front page.

# Thank you for Purchasing MONO's Artisan Mini Deck Oven

Before using your new oven for the very first time, please read and familiarise yourself with the contents of this User Manual and keep it handy for future reference.

If you have any queries regarding your oven, please contact MONO Equipment directly:

- +44 (0)1792 561234
- [sales@monoequip.com](mailto:sales@monoequip.com)
- [spares@monoequip.com](mailto:spares@monoequip.com)
- [techsupport@monoequip.com](mailto:techsupport@monoequip.com)

We wish you the very best of success with your new professional Artisan Mini Deck Oven.

Happy baking!

**The MONO Team**



# Safety Symbols

The following safety symbols are used throughout this product documentation and manual (available electronically at [MonoEquip.com](http://MonoEquip.com)). Before using your new equipment, read the instruction manual carefully and pay special attention to information marked with the following symbols.

**DANGER**

■ Indicates an immediate hazard with a high risk which, if not avoided, will result in death or serious physical injury.

---

**WARNING**

■ Indicates a potential hazard with a medium risk which, if not avoided, could result in death or serious physical injury.

---

**CAUTION**

■ Indicates a hazard with a low risk which, if not avoided, could result in minor or moderate physical injury.

---

# Electrical Safety Notice

## Advice regarding supplementary electrical protection

Commercial bakeries, kitchens and food service areas are environments where electrical appliances may be located close to liquids, or operate in and around damp conditions, or where restricted movement for installation and service is evident.

The installation and periodic inspection of the appliance should only be undertaken by a qualified, skilled and competent electrician, and connected to the correct supply suitable for the load as stipulated by the appliance data label.

The electrical installation and connections should meet the necessary requirements of the local electrical wiring regulations and any electrical safety guidelines.

### We recommend:

- Supplementary electrical protection with the use of a residual current device (RCD.)

### Your attention is drawn to: BS 7671:2018 – Guidance Note 8 – 8.13: Other locations of increased risk

It is recognised that there may be locations of increased risk of electrical shock other than those specifically addressed in Part 7 of BS 7671. Examples of such locations could include laundries where there are washing and drying machines in close proximity, and water is present, and commercial kitchens with stainless steel units, where once again, water is present. Where, because of the perception of additional risks being likely, the installation designer decides that an installation or location warrants further protective measures, the options available includes:

- Automatic Disconnection of Supply (ADS) by means of a residual current device having a residual operating current not exceeding 30 mA.



### WARNING

- The supply to this machine must be protected by a 30mA-rated Type 'A' Residual Current Device (RCD).
  - Before installation, it is recommended that a qualified electrician first tests the power socket for electrical safety.
-

---

# Water Leak Safety Notice

**WARNING**

**Take action immediately to get a water leak fixed and prevent death or serious injury from electrocution.**

---

It is essential to regularly check for any signs of a water leak from an oven installation. If there is evidence of a water leak, do not ignore it. Immediately report it to a manager or as applicable to your organisation.

Furthermore:

- Disconnect or completely isolate the oven from the electrical supply.
- Place an out-of-service notice on the oven.
- Contact your oven supplier or MONO Equipment for technical assistance.

Ovens must be maintained and serviced at appropriate intervals to ensure the oven operates at optimum levels.

# General Notices



## CAUTION

### ■ Users with Implantable Cardioverter Defibrillators and Pacemakers

- Several common types of devices and machinery may interfere with implantable cardioverter defibrillators (ICDs) and pacemakers, including mobile phones, headphones, radios, machinery, and magnets.
- The electromagnetic waves generated by these devices can keep your ICD or pacemaker from functioning correctly. Try to avoid them, or at least minimise your exposure to them.
- Your healthcare professional can advise you about specific devices and machinery to avoid.



## NOTICES

### ■ Warranty information

- Ambient working temperatures for electrical components, such as solenoid switches, circuit breakers and motors, should not exceed 40 °C (115 °F). Manufacturers of these, and other electrical components, advise that any ambient temperature above this affects the functionality of the components. Any related guarantees become void.
- It is the owners' responsibility to ensure adequate ventilation is provided. Any component malfunctioning during the guarantee period found to have been subjected to excessive humidity or ambient working temperatures is not covered by the component manufacturer's or MONO Equipment's product warranty.
- Failure to adhere to the cleaning and maintenance instructions detailed in this User Manual also could affect the warranty of this machine.
- Visit the [MONO Parts and Labour Warranty page](#) for further information.





### ■ Continuous improvements

- As it is our policy to improve our machines continuously, we reserve the right to change specifications without prior notice.

### ■ Engineers/Electricians-only sections of the User Manual

- Technical sections of this User Manual are for suitably qualified experienced persons only. Customers must never make any modifications or repairs to MONO's machines.

# Declaration of Conformity Certificate

	<h2>Declaration of Conformity</h2>							
<p>We the manufacturer:</p>	<p><b>MONO EQUIPMENT</b> Queensway, Swansea West Industrial Park, Swansea SA5 4EB UK</p>	<table border="1" style="width: 100%; border-collapse: collapse;"> <tr> <td style="padding: 2px;"><b>Machine:</b></td> <td style="width: 80%;"></td> </tr> <tr> <td style="padding: 2px;"><b>FG Code:</b></td> <td></td> </tr> <tr> <td style="padding: 2px;"><b>Serial No:</b></td> <td></td> </tr> </table>	<b>Machine:</b>		<b>FG Code:</b>		<b>Serial No:</b>	
<b>Machine:</b>								
<b>FG Code:</b>								
<b>Serial No:</b>								
<p>Hereby declare that this machine conforms with and complies with the following directives:</p> <ul style="list-style-type: none"> <li>→ The Machine Directive <b>2006/42/EC</b></li> <li>→ The Low Voltage Directive <b>2014/35/EC</b></li> <li>→ The Electromagnetic Compatibility Directive 2014/30/EU Incorporating Standards <b>EN 55014-1:2017/A11:2022 &amp; EN 55014-2:1997+A1:2001+A2:2008</b></li> <li>→ The General Safety of Machinery and Food Processing Standards</li> <li>→ Materials and Articles Intended to Come into Contact with Food – Regulation (EC) No. <b>1935/2004</b></li> <li>→ Good Manufacturing Practices (GMP) for Materials Intended to Come into Contact with Food - Regulation (EC) No. <b>2023/2006</b></li> </ul>								
<p>A technical construction file for this machine is retained at MONO Equipment</p>								
<p><b>MONO Equipment</b> is a business name of <b>AFE Group Ltd</b> Registered in England No. 3872673 VAT Registration No. 923428136</p> <p>Registered office: Unit 35, Bryggen Road, North Lynn Industrial Estate, Kings Lynn Norfolk, PE30 2HZ</p>								
 <hr style="width: 100%;"/> <p>Mr Craig Petherbridge Quality &amp; Compliance Manager</p>	 <hr style="width: 100%;"/> <p>Mr Alex Davies Engineering Manager</p>							
<p>QD 001</p>		<p>Dated 01/11/2022</p>						

# Contents

	<b>Manual Revisions.....</b>	<b>i</b>
	<b>Thank you for Purchasing MONO’s Artisan Mini Deck Oven ...</b>	<b>ii</b>
	<b>Safety Symbols .....</b>	<b>iii</b>
	<b>Electrical Safety Notice .....</b>	<b>iv</b>
	<b>Water Leak Safety Notice .....</b>	<b>v</b>
	<b>General Notices .....</b>	<b>vi</b>
	<b>Declaration of Conformity Certificate .....</b>	<b>vii</b>
<b>Chapter: 1</b>	<b>Introduction</b>	
	1.1 The MONO Artisan Mini Deck Oven .....	1
<b>Chapter: 2</b>	<b>Safety</b>	
	2.1 General safety .....	3
	2.2 Oven safety .....	3
<b>Chapter: 3</b>	<b>Installation</b>	
	3.1 Safety messages .....	5
	3.2 Installation guidelines .....	6
<b>Chapter: 4</b>	<b>Operation</b>	
	4.1 Getting started with the Artisan Mini Deck Oven.....	7
	4.2 Preparing the Pressurised Spray Gun Accessory..	11

**Chapter: 5      Cleaning**

5.1      Safety messages ..... 12  
5.2      Daily cleaning ..... 12  
5.3      Weekly cleaning ..... 13  
5.4      Monthly cleaning ..... 13

**Chapter: 6      Maintenance**

Error! Reference source not found. Error! Reference source not found.  
Error! Reference source not found. Error! Reference source not found.

**Chapter: 7      Service**

7.1      Contact information for customer services ..... 16  
7.2      Further information ..... 16  
7.3      Environmental disposal ..... 16

**Appendix: A      Dimensional Drawings ..... 17**

**Appendix: B      Specifications ..... 19**

**Appendix: C      Accessories ..... 21**

**Appendix: D      Spares ..... 23**

**Appendix: E      Electrical Drawings ..... 25**



# 1. Introduction

## 1.1. The MONO Artisan Mini Deck Oven

MONO's Artisan Mini Deck is the perfect oven for enthusiastic home bakers and micro bakeries looking to increase their production. Created to produce beautifully delicious bread, every time, the Artisan Mini Deck oven has been made by bakers, for bakers. The simple-to-use design and small footprint bridge the gap between a domestic home oven and a large professional bakery oven.

The Artisan Mini Deck features three baking stones, four powerful heating elements, a door-mounted manual damper facility and a 'no-nonsense', easy-to-use control panel.

### Optional accessories

A specially designed base unit option frees up precious counter space. It allows the Artisan Mini Deck to be placed anywhere in the bakery whilst providing an area to store three trays of products and additional storage underneath.

Depending on your preference, there are two options for creating steam in the Artisan Mini Deck oven:

- Firstly, specially designed steam troughs can create generous amounts of steam to cover baking bread by simply pouring water into the pre-heated troughs within the oven.
- The second option is to use a food-safe pressurised spray gun that can be hand-pumped to spray measured amounts of water into the oven to create steam.

### Key features

- Three square baking stones, 470mm x 470mm (18½ inches x 18½ inches)
- Four powerful heating elements
- Fibre Concrete baking tiles, 35mm (1¼-inch) thick
- 203mm (8-in.) height between shelves for air circulation
- Dual-temperature manual controls up to 250°C (482°F)
- Door-mounted manual damper facility
- Integrated magnet holder for a dough scorer.

### Key benefits

- Single-phase, 13 Amp plug
- Small footprint to maximise space in the bakery
- Thick solid baking tiles for superb heat retention
- Option of steam troughs or pressurised spray gun for a great crust
- Specially designed base unit to free up worktops
- Strong 'pull-tight' handle to create the perfect door seal
- Manufactured in hygienic stainless steel for ease of cleaning.

**NOTE**

- Visit the [Artisan Mini Deck Oven web page](#) for the latest information about the Artisan Mini Deck Oven. Here you will find PDF downloads of the latest product literature and up-to-date product information.

**Figure 1.1:** Artisan Mini Deck Features

- A. Three baking decks
- B. Magnetic holder
- C. Control panel
- D. Stainless steel construction
- E. Optional racked base unit
- F. Cam-action door handle
- G. Peel holder (mountable on either side)
- H. In-door Damper

## 2. Safety

### 2.1. General safety

**CAUTION****■ Magnets information**

- The Artisan Mini Deck Oven carries a magnet on the top outside corner of the oven, which is a convenient place to attach your dough scorer for safekeeping.
  - Magnetic fields in magnets, used in devices and machinery, can inhibit pulse generators for Implantable Cardioverter Defibrillators (ICDs) and pacemakers. Magnets can activate a switch prohibiting the ICD from delivering vital signals such as lifesaving shocks.
  - If you have an ICD or pacemaker, avoiding close or prolonged contact with magnets or their magnetic fields is advisable. Keep magnets at least six inches from where your device is implanted. **If you feel any interference in any way, immediately move away from the source.**
  - The magnet can be removed easily using a screwdriver by someone unaffected by magnets.
- 

### 2.2. Oven safety

Only fully trained and authorised persons are permitted to work on the oven. Qualified electricians must carry out all electrical repairs and maintenance. Always disconnect or completely isolate the power supply before starting maintenance or cleaning work on the oven.

A responsible Bakery Manager or Supervisor must carry out daily safety checks. Bakery staff must not, under any circumstances, remove covers or panels to access any internal parts of the oven.

**WARNING****■ Before using the oven:**

- Check that all covers, panels, and cabling are secure.
- Visually examine the oven for obvious damage/signs of tampering.

**■ If the oven is damaged, malfunctioning, or missing parts:**

- Stop using it.
- Do not attempt any repairs to the oven.
- Contact MONO Equipment for technical assistance.

**■ Never operate the oven with any covers or panels removed.****■ All utility connections to the oven must comply with the statutory requirements of the country.****■ Ensure this user manual is read thoroughly before operating the oven. Operate and maintain the oven only as described in this user manual.**

---

**WARNING**

- An electrical socket must be protected by a 30mA-rated Type 'A' Residual Current Device (RCD) before installation and commissioning of the oven.
- There should always be a local disconnection switch for any person to isolate the electrical power in an emergency. The disconnection switch must be visible, labelled as an emergency shutdown device, and easily accessible.
- Check the electrical requirements on the oven's information plate before plugging in the power cable and turning the power on for the first time. Contact MONO Equipment if the electrical ratings are incorrect for your site.
- Before installation, it is recommended that a qualified and competent electrician first tests the electrical outlet (power socket) for electrical safety.
- Always ensure your hands are dry before touching any electrical components, including cables, switches, and plugs.

**CAUTION**

- Be aware of a crushing hazard between the door and frame when the door is fully opened.
- Be aware of hot surfaces:
  - Do not touch the oven door with bare skin.
  - Always use oven gloves when loading or unloading the oven.
  - Allow time for the oven to cool completely before cleaning it.
  - While baking (and for some time after use), touching the oven door or the surrounding panels is not advisable because of conducted heat.
- When removing products from the oven, ensure:
  - Tins are knocked out and stored directly onto a tin storage trolley or rack. Do not leave hot tins on the floor or tables.
  - Trays are put into a rack and then wheeled to a safe cooling area.
- Fully train operatives before they use the machine. Anyone undergoing training must be under the direct supervision of someone experienced.
- Ensure there are no trip hazards around the oven, e.g. trailing cables.
- Check that the floor around the oven is not slippery, e.g. no liquid spills.
- Do not store items on top of or behind the oven.
- Never climb onto the roof of the oven.
- Only use the oven for baking bread, pastries, and cakes. Contact MONO Equipment for other product-baking machines.
- No unauthorised modifications to the oven are permitted.
- Do not cover the door-mounted Damper or side-located air vents.
- Ask for assistance when removing the heavy baking tiles.

# 3. Installation

## 3.1. Safety messages



**WARNING**

- An electrical socket must be protected by a 30mA-rated Type 'A' Residual Current Device (RCD) before installation and commissioning of the oven.
- There should always be a local disconnection switch for any person to isolate the electrical power in an emergency. The disconnection switch must be visible, labelled as an emergency shutdown device, and easily accessible.
- Check the electrical requirements on the oven's information plate before plugging in the power cable and turning the power on for the first time. Contact MONO Equipment if the electrical ratings are incorrect for your site.
- Before installation, it is recommended that a qualified and competent electrician tests the electrical outlet (power socket) for electrical safety.
- Always ensure your hands are dry before touching any electrical components, including cables, switches, and plugs.



**CAUTION**

- This equipment is too heavy for a single person to lift.
- Do not cover the air vents on the sides of the oven.

Figure 3.1: Example of an RCD Power Socket.

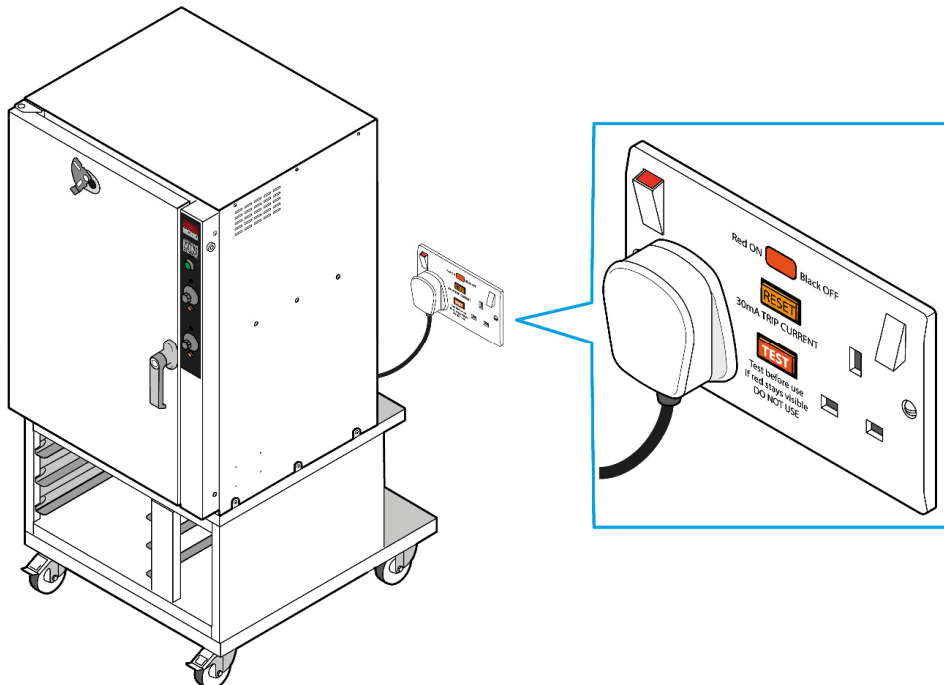

## 3.2. Installation guidelines

### Important information about installing the oven

- A solid, smooth, and level floor is recommended on which to position the oven mounted on the optional racked base unit. Alternatively, position the oven on a suitably robust worktop supporting 150kg.
- The Artisan Mini Deck Oven is not designed to be a built-in appliance where only the front is accessible. Allow sufficient room for ventilation and for side and rear panels to be accessed during maintenance work.
- Operational clearance of 50mm (2 inches) is required at the rear and sides of the oven, and 250 mm (10 inches) top clearance to allow for airflow.
- It is recommended to site an extraction hood above the oven to disperse excess steam and heat, which could otherwise adversely affect the bakery ceiling and ambient temperature.
- The ventilation of steam from the oven must be sufficient to ensure water does not condense on or around the oven. Any water ingress could affect the product warranty. It is the owners' responsibility to ensure adequate ventilation is provided. Any component malfunctioning during the guarantee period found to have been subjected to excessive humidity or ambient working temperatures above 40 °C (115 °F) is not covered by the component manufacturer's or MONO Equipment's product warranty.
- Before first use, MONO recommends that you:
  - Thoroughly wipe the inside surfaces of the oven and all accessories with a clean cloth soaked in warm soapy water. Although the utmost care is taken during assembly and delivery, there is a possibility of residue contaminating your first bake unless it is done.
  - 'Season' the baking tiles by turning both Temperature Dials to 150°C and leaving the oven on for between 5 and 6 hours. This preparatory step removes all moisture that may have entered the baking tiles during storage or transit.
- Ensure the locking castors on the rack base unit (if supplied) are locked in position.
- Do not slam the oven door shut, and always ensure the handle is positioned horizontally to the left-hand side before closing (**Figure 3.2 | A**).
- To close and engage the door with the latch mechanism, turn the handle counterclockwise until it points downwards in the vertical position. This action pulls the door tight against the door seal (**Figure 3.2 | B**).

**Figure 3.2:** How to close the oven door correctly.

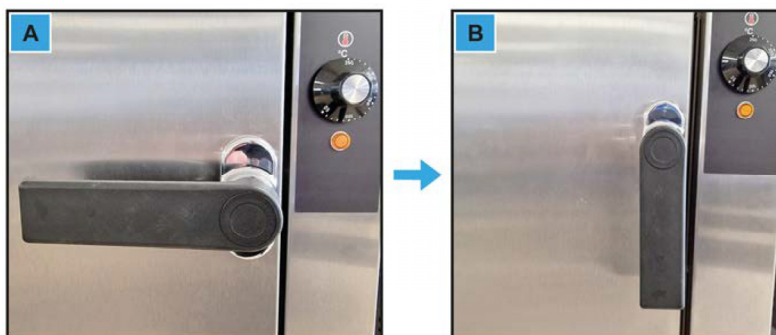

## 4. Operation

### 4.1. Getting started with the Artisan Mini Deck Oven

The following instructions guide you through using the oven for the first time.

1. If using steam troughs (optional) to create steam during baking, place one on each deck in the oven chamber against the side wall.

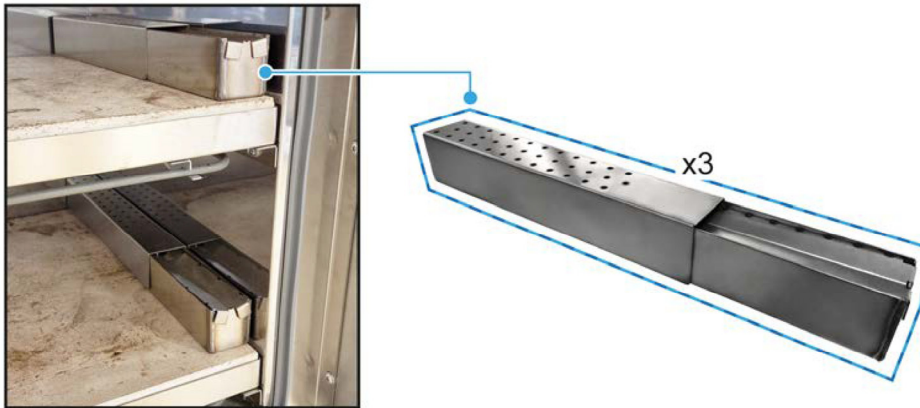

2. If using the pressure spray gun (optional), first read [Section 4.2 on page 11](#).
3. Plug the power cable into a suitable electrical outlet and switch the electrical supply on.
4. Ensure the oven door is closed tightly.
5. Close the Damper if it is open.

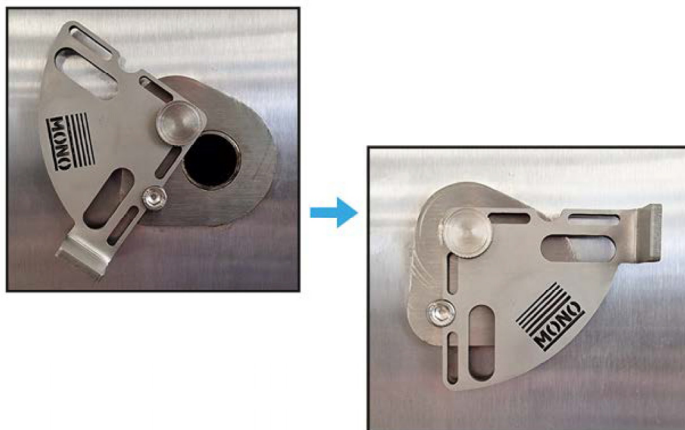

- Press the ON/OFF Power button on the oven to switch the oven on.



- With the power button now illuminated to indicate that the oven is on, turn the Temperature Control Dial(s) to the required temperature in °C.

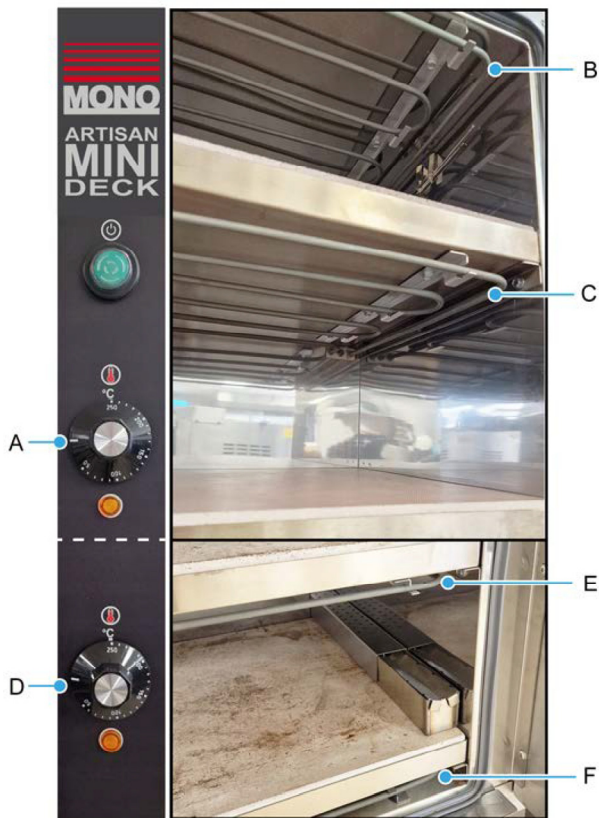

- The top Temperature Control Dial (**A**) controls the topmost heating element (**B**) and the element (**C**) underneath the top baking deck.
  - The bottom Temperature Control Dial (**D**) also controls the heating element (**E**) underneath the middle baking deck and the element (**F**) underneath the bottom baking deck.
- Observe the amber light immediately below the Temperature Control Dial illuminate to indicate that the heating elements are on and the oven is warming up.

9. Wait until the amber light goes off to indicate the oven has reached the set temperature.

**NOTE**

- The oven should reach temperature in around 1 to 1½ hours, depending on the temperature selected and the ambient room temperature.
- 

10. As soon as the oven temperature has been reached:
  - a. Open the door.
  - b. Carefully load dough/products onto the baking tiles directly or in trays.

**NOTE**

- Avoid placing sugary or fatty products, which are prone to leak, directly on the baking tile to avoid undesirable staining and unpleasant odours. Place the product on baking trays instead.
- 

11. If baking on residual heat, turn the Temperature Control Dial(s) to “0”.
12. If steam is required, and the optional steam troughs are being used, pour up to 200ml (7oz) of water into each trough to generate instant steam.

**CAUTION**

- **Be careful not to suffer burns during this steam-generating process. If the troughs are overfilled, any remaining water stays in the troughs until the bars are hot enough to create steam again. Therefore, it is advisable not to overfill.**
- 

13. If steam is required, and the optional pressure spray gun is to be used, spray the product and the oven chamber until the desired amount of steam is created. With practice, you find how much water to spray and generate the precise amount of steam to get the finished crust you want.

14. Close the door and ensure the handle has pulled the door tight to the seal.

**NOTE**

- Do not slam the oven door closed, and always ensure the handle is positioned to the left-hand side before closing (A). Turn the handle counterclockwise until pointing downwards to ensure the handle and latch make contact and pull the door tight (B).

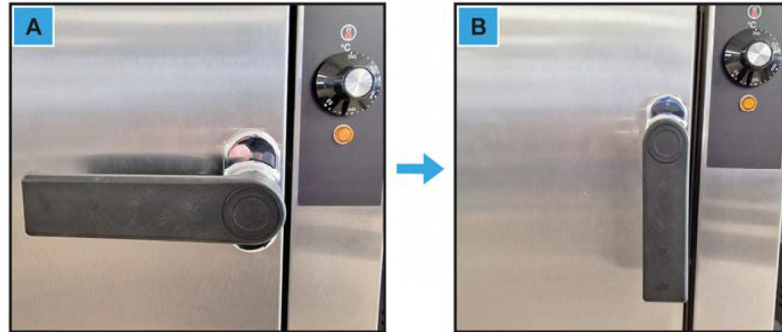

15. Set a timer and bake for the required duration to suit the recipe.
16. Approximately 10 minutes before the end of the bake, open the Damper on the front door by turning it counterclockwise to release steam and moisture from the oven.

**CAUTION**

- **Be careful not to suffer burns from steam. Stand clear of the oven immediately after opening the Damper.**

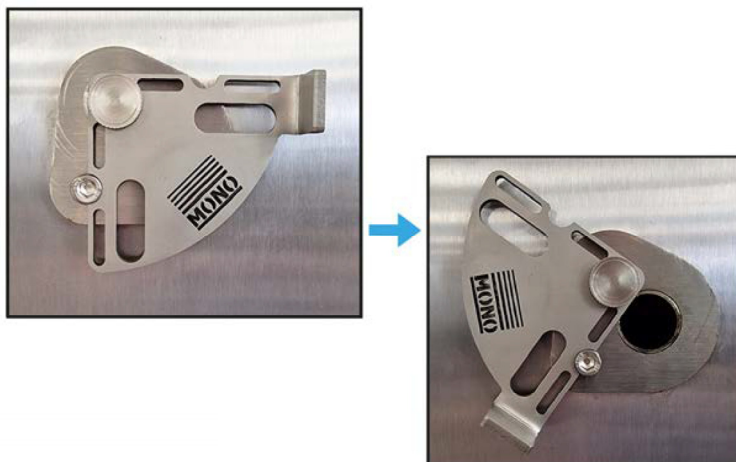

17. After the baking is complete, turn the oven off by pressing the **Power ON/OFF pushbutton**.
18. Observe the ON/OFF light go out to indicate the oven is switched off.

- Carefully open the door and remove the baked product from the oven.



- Place the baked product on cooling racks.
- If another bake is required, close the door and Damper. Repeat the steps to get the oven to return to temperature.

**CAUTION**

- **After baking, be careful not to suffer heat burns. Residual heat remains in the oven for several hours.**

## 4.2. Preparing the Pressurised Spray Gun Accessory

The following instructions guide you through preparing and using the optional Pressurised Spray Gun accessory.

- Clean the Pressurised Spray Gun before the first use.
- Unscrew the water bottle from the handle and spray mechanism.
- Fill the water bottle to the “max” level and tightly screw the handle and spraying mechanism back on.
- Pump air into the water bottle and create pressure using the hand piston.
  - Between 20 to 30 pumps should be enough.
- Pull the trigger to test the spray.
  - The tip of the nozzle can be rotated to adjust the spray pattern.

**CAUTION**

- Never leave the Spray Gun in a pressurised state for an extended period. Unscrew the spray head slowly to release the pressure. Empty the unused water after use.

## 5. Cleaning

### 5.1. Safety messages



#### WARNING

- Always disconnect or isolate the electrical supply and allow the oven to cool before cleaning.
  - Be aware that the surfaces of the oven can remain hot for several hours. Wear protective gloves and appropriate clothing when cleaning.
  - Do not remove any covers, panels, or pipe fittings for cleaning.
  - Do not clean the oven while it is powered or operating.
- 



#### CAUTION

- Clean the oven by following the daily, weekly, and monthly tasks in this User Manual.
  - Use only a mild, chloride-free cleaning product on outside surfaces.
  - Use only food-safe (HACCP) cleaning products on food-contact areas. Wipe thoroughly with a damp cloth afterwards.
  - Never use aggressive chemicals, i.e. solvents, thinners, etc.
  - Take care that liquid does not enter the control panel or any of the other access covers/panels.
  - Never spray the oven with water (or any kind of liquid) using a hose or pressure washer. Never use compressed-air jets on the oven.
  - Care must be taken to not damage parts inside the oven.
- 

### 5.2. Daily cleaning

**Before undertaking this task, ensure the oven is unplugged from the mains power supply and that the oven and elements are completely cold.**

#### Daily cleaning tasks

1. Sweep any debris out of the oven after it has been allowed to cool.
  - Cooling down could take several hours.
  - Use a vacuum cleaner if necessary, **but only when the oven is completely cold.**
2. Wipe the oven front, back, and sides with a damp cloth.
3. Spot clean outside with a damp cloth, soaked in a solution of mild detergent and hot water.
  - Pay particular attention to ensure excess water is not applied near electrical panels.

## 5.3. Weekly cleaning

**Before undertaking this task, ensure the oven is unplugged from the mains power supply and that the oven and elements are completely cold.**

### Weekly cleaning tasks

1. Complete the daily cleaning procedure.
2. Clean any burnt-on debris by scrubbing it with a stiff brush and, if necessary, a damp cloth.
3. Use a nylon brush to scrub the cabinet wheels (if fitted) with a mild detergent and hot water.
  - Using too much water eventually rusts the metalwork.

## 5.4. Monthly cleaning

**Before undertaking this task, ensure the oven is unplugged from the mains power supply and that the oven and elements are completely cold.**

The baking tiles and trays can be removed from the shelves to clean any debris from underneath the baking tile and inside the tile tray. The baking tiles and trays are hefty to maneuver. **Two people are needed to do this task safely due to the weight of the baking tiles.** Always take extra care when removing these items from the oven and re-fitting them.

### Monthly cleaning tasks

1. The bottom baking tile and tray can just be pulled out carefully from the oven and removed, as it is not attached to the bottom element.
2. The top and centre baking tiles and trays need to be disconnected from the elements found beneath the trays. To do this:
  - a. Grab the left-hand and right-hand sides of the front-facing element and pull towards you.

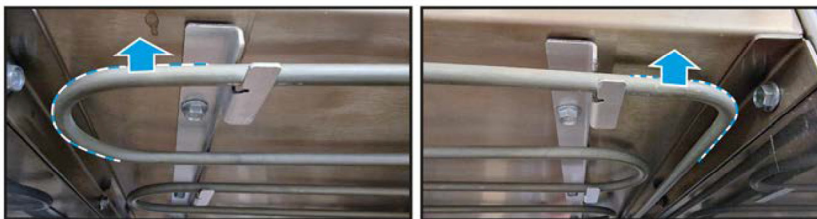

- b. After releasing this part of the element from the two retaining clips, use the same method to release the element from the retaining clips along the centre and back of the tile tray.
- c. With the element no longer connected to the tile tray, carefully pull the tray from the oven.
- d. After removal, carefully flip the baking tile and tray upside down onto a padded surface, taking care not to trap your fingers underneath.
- e. Lift the tray off the baking tile.

3. Any debris can now be brushed or removed from the tray and the underside of the baking tile.
4. After cleaning, replace the baking tray on top of the baking tile. Carefully flip them over, ensuring you do not trap your fingers.
5. Slide the baking tile and tray back into the oven until it touches the oven's back wall.
6. For the top and middle shelves only, re-attach the elements starting at the back of the tray and working your way through the centre fixings to the front.
7. Check that all six element fixings have been engaged underneath each tray.

## 6. Maintenance

### 6.1. Safety messages

**WARNING**

- Always disconnect or isolate the electrical supply before starting any maintenance work on the oven.
  - Some components stay electrically energised even after the main isolator is in the 0 (OFF) position.
- 

**WARNING**

- The Artisan Mini Deck Oven must be maintained at regular intervals. The frequency of maintenance will depend upon your specific use and location. The maximum service interval should be 12 months.
  - Service and maintenance should only be undertaken by suitably experienced and qualified persons (SEQP).
  - You must immediately report any damage or defect arising with the appliance.
  - Unsafe equipment is dangerous. Do not use the appliance. Isolate the power supply and contact MONO Equipment or your appointed service agent.
- 

### 6.2. General maintenance

The following general maintenance is recommended:

- Check for any visible damage.
  - Do not use the machine if clearly damaged, i.e. frayed or bare cables are visible.
  - Report the damage, but do not attempt to make any repairs yourself.
- Follow the cleaning instructions in [Chapter 5](#).

## 7. Service

If a fault arises, please do not hesitate to contact MONO Equipment's Service and Spares department. Be prepared to provide the Serial Number from the machine's information plate or the front page of this User Manual in all communications.

### 7.1. Contact information for customer services

#### **MONO Equipment Limited**

Queensway  
Swansea West Industrial Park  
Swansea  
SA5 4EB  
United Kingdom  
[www.monoequip.com](http://www.monoequip.com)

#### **Contacts**

[spares@monoequip.com](mailto:spares@monoequip.com)  
+44 (0)1792 564039

[techsupport@monoequip.com](mailto:techsupport@monoequip.com)  
+44 (0)1792 564041

[service@monoequip.com](mailto:service@monoequip.com)  
+44 (0)1792 564048

Switchboard  
+44 (0)1792 564039

### 7.2. Further information

Visit [MonoEquip.com](http://MonoEquip.com) for the latest versions of this user manual. Also find up-to-date information about all MONO's products.

### 7.3. Environmental disposal

Dispose of the machinery with care when it comes to the end of its working life. Use the most environmentally friendly manner possible by recycling or other means of disposal which complies with local regulations. Only dispose of the machine safely and legally. The Environmental Protection Act 1990 applies in the United Kingdom.

# A. Dimensional Drawings

## A.1 Artisan Mini Deck Oven dimensional drawings

Figure A.1: Oven with the racked base unit (oven door closed).

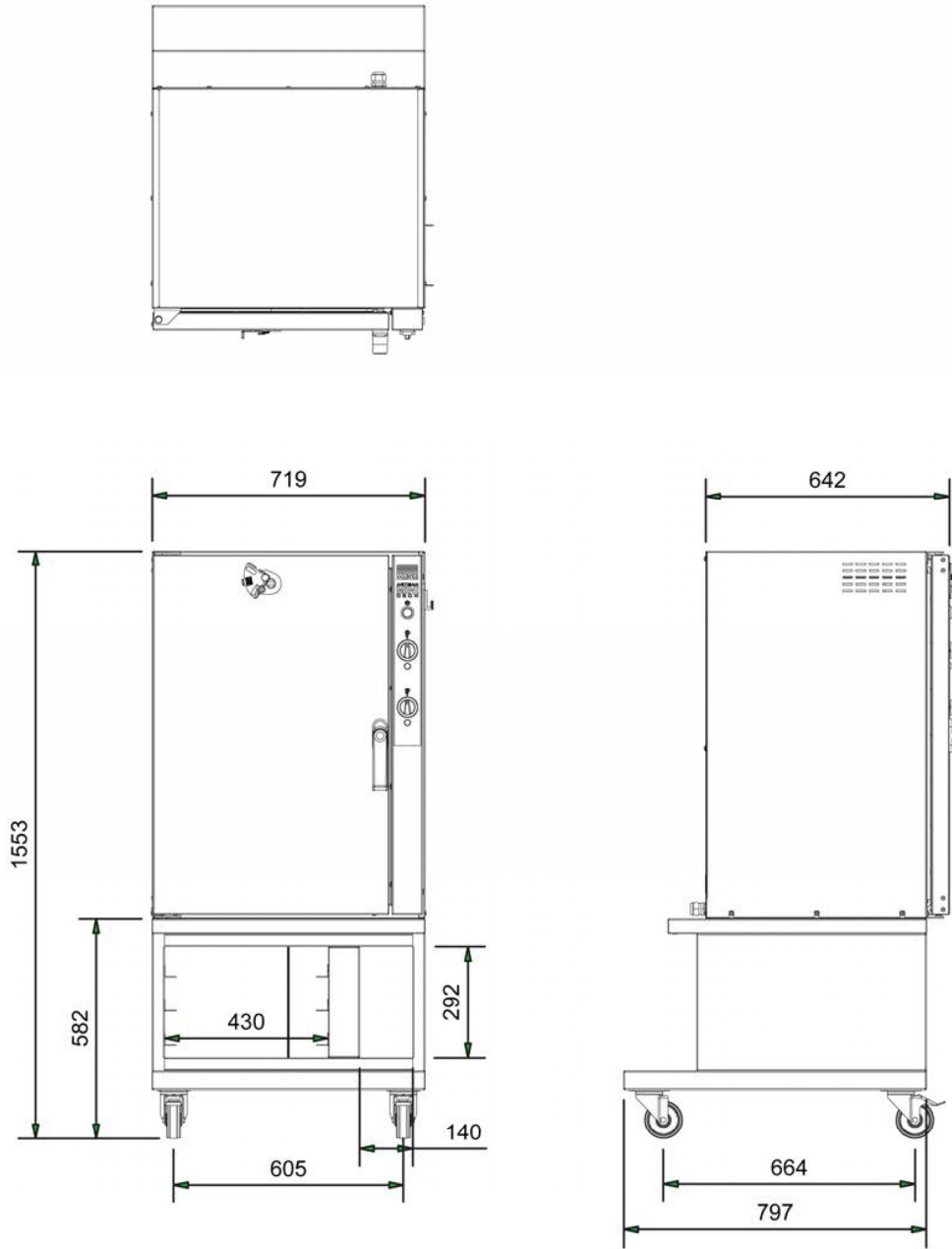

Dimensions are in mm unless otherwise stated.

Figure A.2: Oven with the racked base unit (oven door open).

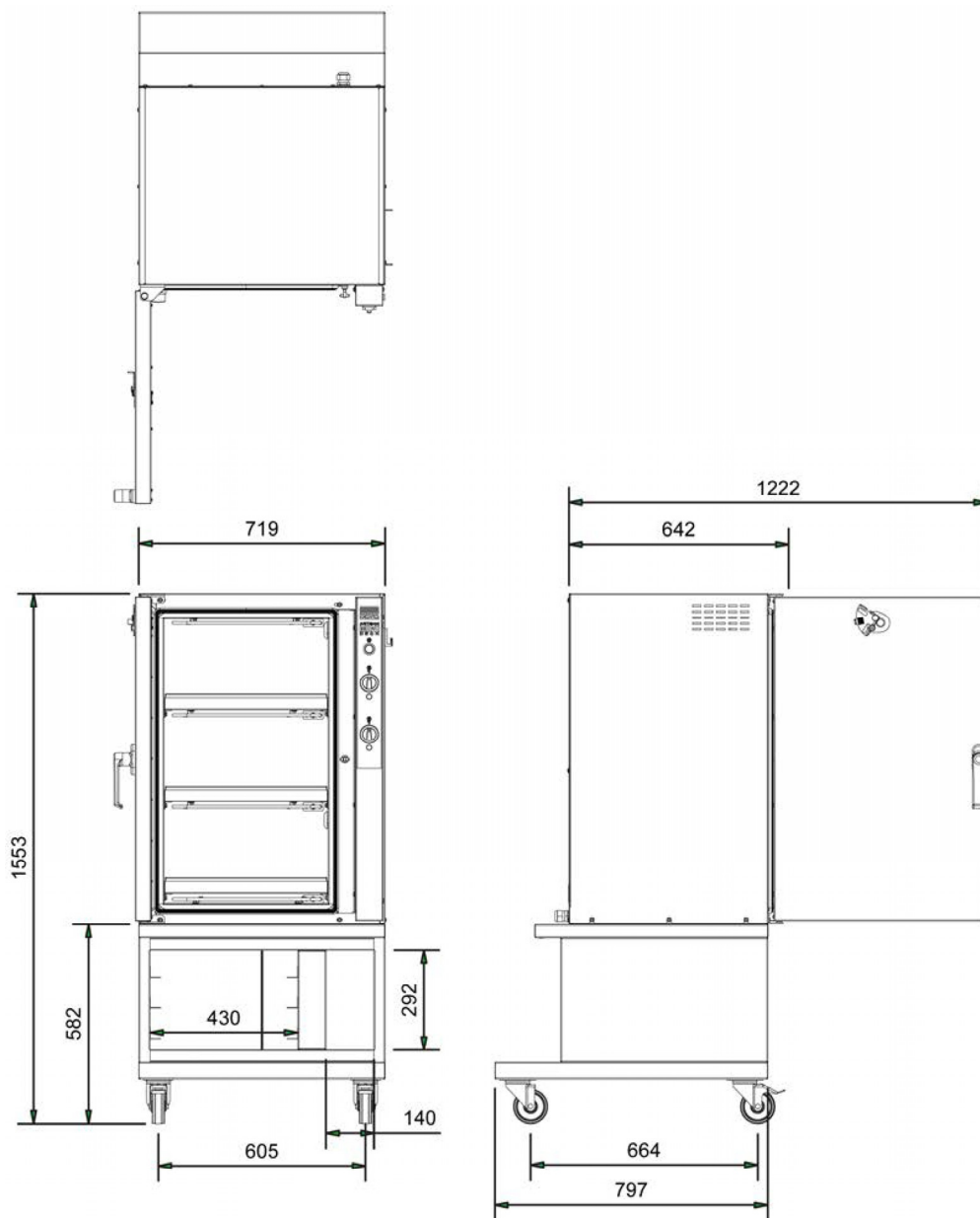

Dimensions are in mm unless otherwise stated.

## B. Specifications

### B.1 Electrical specifications

The electrical loadings in [Table B.1](#) are for the complete oven.

**Table B.1:** Electrical loadings.

Option 1 specifications	Oven only
Electrics	Single phase, 230Vac (50Hz), 13 Amps
Power (kW)	2.4

Option 2 specifications	Oven only
Electrics	Single phase, 220Vac (60Hz), 13 Amps
Power (kW)	2.7



**WARNING**



An electrical socket must be protected by a 30mA-rated Type 'A' Residual Current Device (RCD) before installation and commissioning of the oven.

### B.2 Mechanical specifications

**Table B.2:** Mechanical specifications for the Artisan Mini Deck Oven.

Specifications <sup>(1)</sup>	Oven only	Oven with Base Unit
Width	719mm (28 <sup>1</sup> / <sub>3</sub> -in.)	719mm (28 <sup>1</sup> / <sub>3</sub> -in.)
Depth - door closed <sup>(1)(2)</sup>	642mm (25 <sup>1</sup> / <sub>4</sub> -in.)	797mm (31 <sup>1</sup> / <sub>3</sub> -in.)
Depth - door opened <sup>(1)(2)</sup>	1222mm (48 <sup>1</sup> / <sub>4</sub> -in.)	1377mm (54 <sup>1</sup> / <sub>4</sub> -in.)
Height	971mm (38 <sup>1</sup> / <sub>4</sub> -in.)	1553mm (61 <sup>1</sup> / <sub>4</sub> -in.)
Number of baking decks	3	3
Internal baking area per deck	470mm x 470mm (18 <sup>1</sup> / <sub>2</sub> -in. x 18 <sup>1</sup> / <sub>2</sub> -in.)	470mm x 470mm (18 <sup>1</sup> / <sub>2</sub> -in. x 18 <sup>1</sup> / <sub>2</sub> -in.)
Height between decks <sup>(3)</sup>	203mm (8-in.)	203mm (8-in.)

(1) See [Appendix A.1](#) for all dimensions.

(2) Depth measurement excludes the door handle.

(3) Height dimension includes the elements.

## B.3 Environmental specifications

### Noise level

The noise level is less than 80 dB.



## B.4 Functional specifications

**Table B.3:** Functional specifications for the Artisan Mini Deck Oven.



Specifications	Oven only
Temperature controls	2
Damper controls	Yes
Steam Troughs (accessory)	3 (1 per deck)
Spray gun capacity (accessory)	1.2 litres (42 oz.)

## C. Accessories

**Table C.1: Artisan Mini Deck Oven accessories.**

Item description	Part number	Quantity	Image
<p><b>Pressurised spray gun</b></p> <ul style="list-style-type: none"> <li>■ Hand-pump action produces up to 3 Bar of pressurised water (300 ml or 10 oz per minute).</li> <li>■ Creates copious amounts of steam when sprayed in the oven.</li> <li>■ 1.2-Litre (42oz) capacity.</li> <li>■ Certified for use in food industry applications.</li> </ul>	041-11-00060	1	
<p><b>Steam troughs</b></p> <ul style="list-style-type: none"> <li>■ Made from stainless steel and contains a mild steel rebar.</li> <li>■ Creates generous amounts of steam.</li> <li>■ Simply place the Steam Trough on each deck whilst the oven is heating-up.</li> <li>■ When required during the baking cycle, pour water into each trough to create a beautiful crusty finish to your loaves.</li> </ul>	041-11-00030	3 (1 per shelf)	
<p><b>Bread peel<sup>(1)</sup></b></p> <ul style="list-style-type: none"> <li>■ The ideal tool for loading your dough and unloading your baked bread fresh from the oven's sole plate.</li> <li>■ A must-have accessory for all micro and artisan bakers.</li> <li>■ It can be mounted on either side of the oven for safe keeping.</li> <li>■ Mounting bracket 041-11-00050.</li> </ul>	041-11-00040	1	

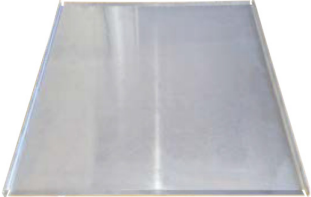
**Table C.1: Artisan Mini Deck Oven accessories (Continued).**



Item description	Part number	Quantity	Image
<p><b>Racked unit<sup>(2)</sup></b></p> <ul style="list-style-type: none"> <li>■ Sturdy and handy base for top-mounting the oven.</li> <li>■ Manufactured in stainless steel.</li> <li>■ 3-tray capacity and additional storage.</li> <li>■ Removable shelves.</li> <li>■ Lockable castors.</li> <li>■ See <a href="#">Table D.1</a> for spare parts.</li> </ul>	FG041-X01	1	
<p><b>Baking tray</b></p> <ul style="list-style-type: none"> <li>■ Aluminium baking tray for the Artisan oven.</li> <li>■ 42 cm x 45½ cm (16½ inches x 18 inches).</li> <li>■ Ideal for baking products high in fat or sugar which are prone to leak.</li> </ul>	041-11-00010	1	
<p><b>Air-vent hook</b></p> <ul style="list-style-type: none"> <li>■ Constructed from stainless steel.</li> </ul>	041-11-00020	2	

(1) Image is for illustrative purposes only. Contact MONO Equipment for further information.

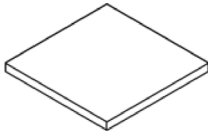
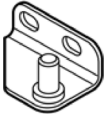
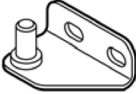
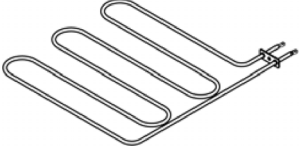
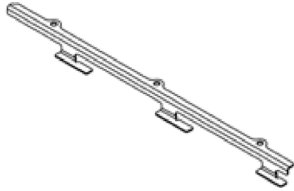

(2) See [Appendix A](#) for dimensions of the oven mounted on this racked unit.

# D. Spares

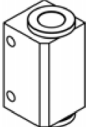
**Table D.1:** Artisan Mini Deck Oven spare parts.

Part number	Item description	Quantity	Image
041-01-01200	Oven door seal	1	
041-01-01900	Firebrick baking shelf	3 (1 per shelf)	
041-03-00400	Door hinge bracket and pin (top)	1	
041-03-00600	Door hinge bracket and pin (bottom)	1	
041-25-00400	Oven heating element, 600W, 230Vac (suitable for single-phase, 230Vac (50Hz), 13Amps, 2.4kW oven version)	4	
041-25-00900	Oven heating element, 600W, 208Vac (Suitable for single-phase, 220Vac (60Hz), 13Amps, 2.7kW oven version)	4	
041-01-01700	Element support bracket	8	
041-90-00100	Button overlay	1	
150-03-06600	Door hinge block	1	

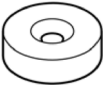
**Table D.1: Artisan Mini Deck Oven spare parts (Continued).**

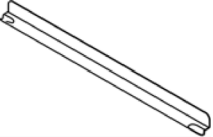
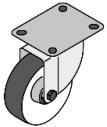
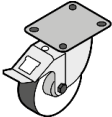
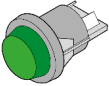
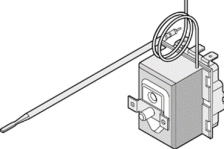
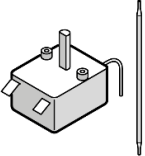
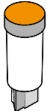
Part number	Item description	Quantity	Image
A900-27-248	Pot magnet	1	
A900-27-263	Door handle	1	
B888-47-001	Temperature control dial	2	
155-00-00100 <sup>(1)</sup>	Removable runner, 581mm long	6	
A900-20-050 <sup>(1)</sup>	Castor Wheel, 100mm	2	
A900-20-054 <sup>(1)</sup>	Castor Wheel (lockable), 100mm	2	
B836-07-009	ON/OFF power pushbutton, green	1	
B888-30-014	Thermostat, triple-pole, manual reset	2	
B888-30-016	Thermostat, 250°C	2	
B842-43-002	Orange indicator light	2	

(1) Spare part for Racked Base unit.

# E. Electrical Drawings

## Index

---

Figure E.1	Front Panel Wiring (Electrical Drawing No. 041E25-00001).....	E.26
Figure E.2	Rear Terminal Block Wiring (Electrical Drawing No. 041E25-00002) .....	E.27
Figure E.3	Front Panel Layout (Electrical Drawing No. 041E25-00003).....	E.28
Figure E.4	System Schematic (Electrical Drawing No. 041E25-00004).....	E.29

---

Figure E.1: Front Panel Wiring (Electrical Drawing No. 041E25-00001)

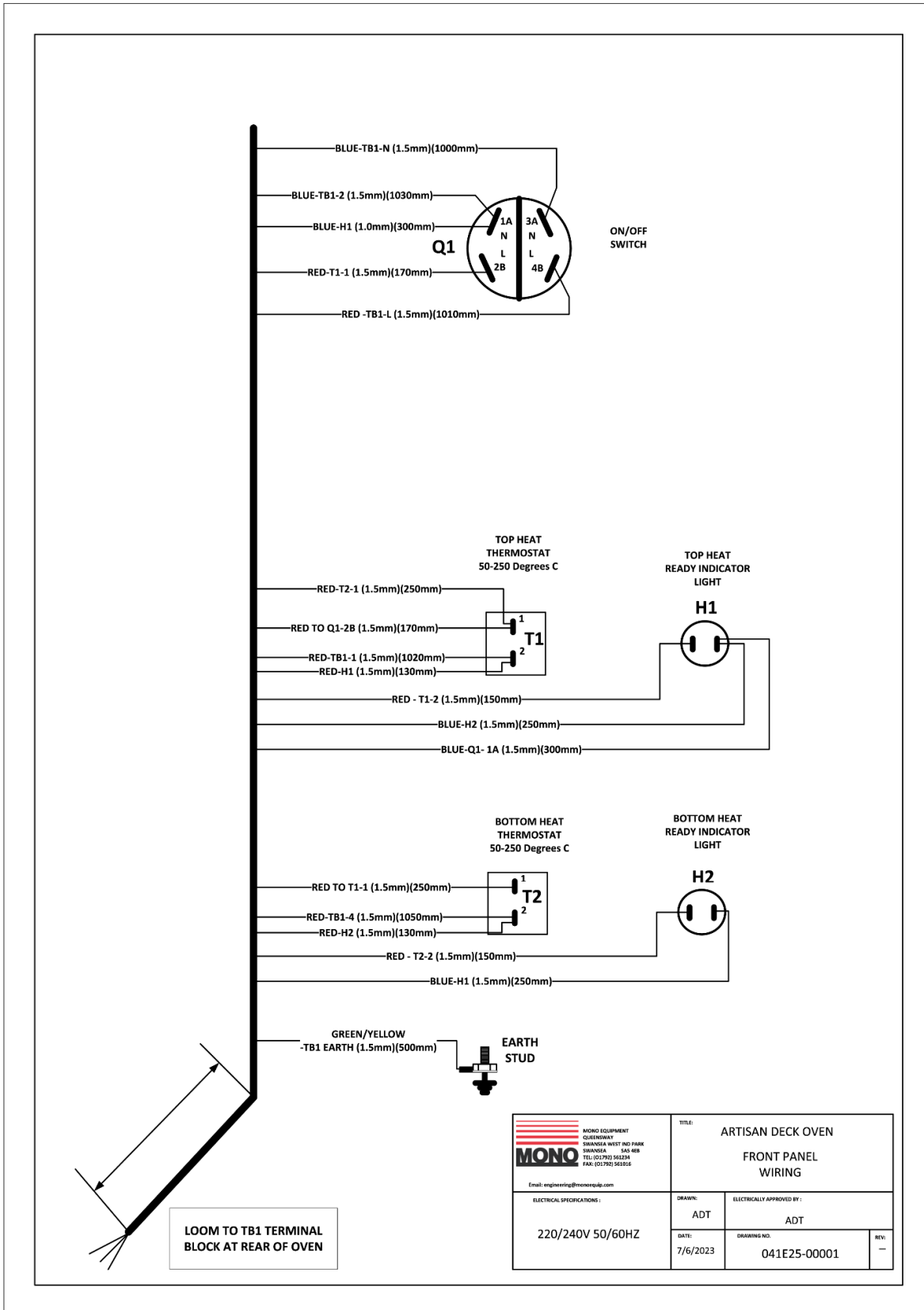

Figure E.2: Rear Terminal Block Wiring (Electrical Drawing No. 041E25-00002)

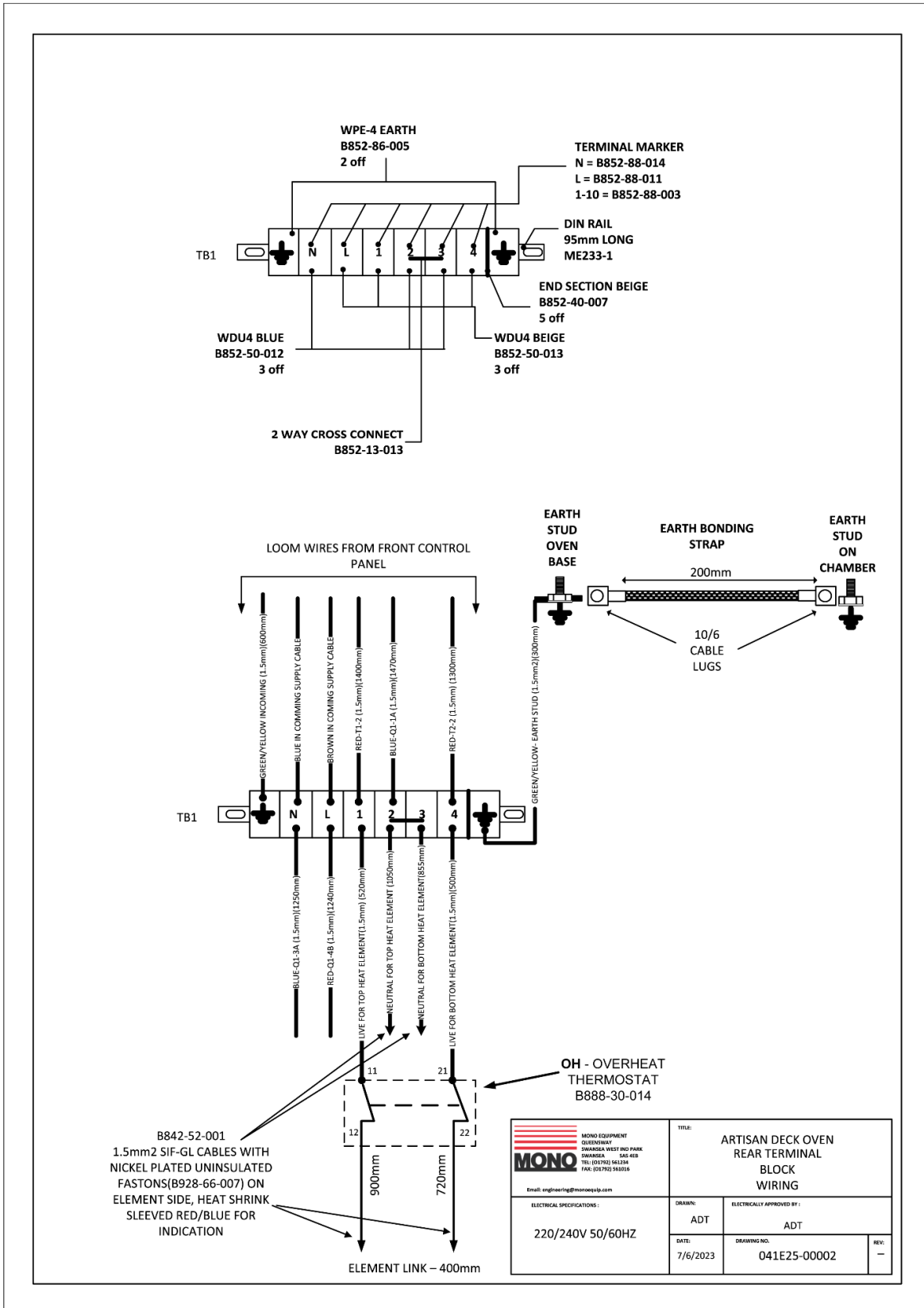
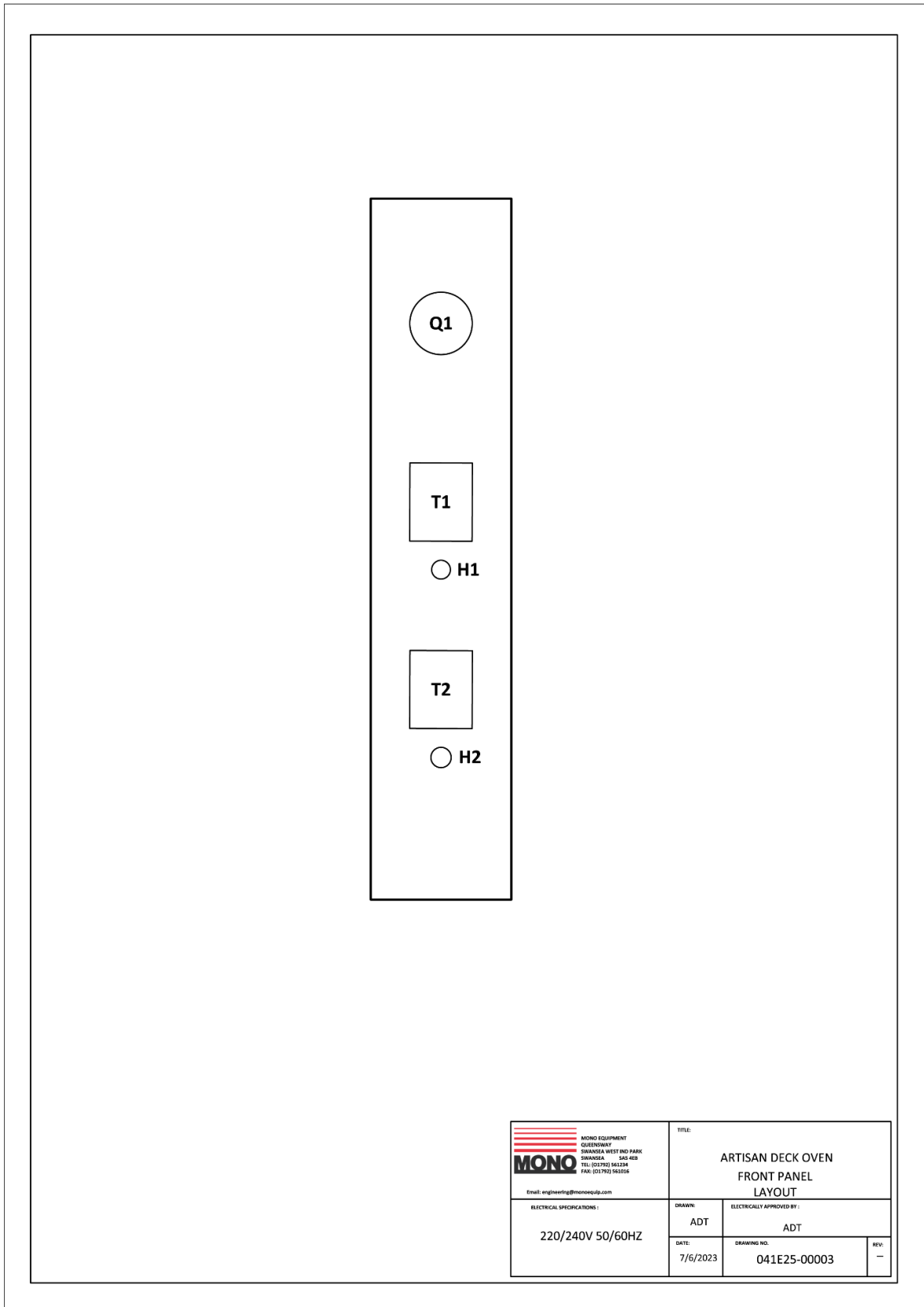

Figure E.3: Front Panel Layout (Electrical Drawing No. 041E25-00003)







---

MONO Equipment is the leading designer and manufacturer of bakery equipment in the United Kingdom. This proud heritage of British craftsmanship, combined with a reputation for creating high-quality, innovative products, can be traced back to its origins in 1947.

All our bakery equipment is manufactured to the most stringent NQA ISO9001:2015 & NQA ISO14001:2015 standards and is crafted using the very latest, cutting-edge technology combined with the time-honoured skills of the master craftsman.

MONO Equipment truly excels in providing tailor-made solutions to a diverse range of clients, from the small independent artisan baker to the large retail chains found on every high street and in every out-of-town shopping centre. We can supply everything from a simple Food-2-Go cafe oven to the entire list of bakery equipment needed to set up a full scratch bakery.



**MONO Equipment Limited**

Queensway  
Swansea West Industrial Park Swansea  
SA5 4EB

Tel: +44 (0)1792 561 234 (Switchboard)  
Tel: +44 (0)1792 564 000 (UK Sales)  
Tel: +44 (0)1792 564 004 (International Sales)  
Tel: +44 (0)1792 564 048 / +44 (0)1792 564 049 (Spares)  
Fax: +44 (0)1792 561 016

Email: [sales@monoequip.com](mailto:sales@monoequip.com)  
Web: [www.monoequip.com](http://www.monoequip.com)



*Scan using your smart phone to connect with us.*



*Scan using your smart phone to view our website.*

