



MonoEquip.com

MONO Eco Connect Convection Oven

EN

Quick Start Guide



Oven Serial Number _____

Oven Code 138 149 150 153 158 159 170 173

Condenser Serial Number _____ (if fitted)

In the event of an enquiry, please quote these serial numbers.

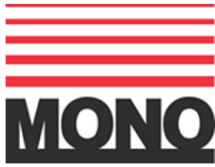

DECLARATION OF CONFORMITY

We hereby declare that this machine complies with the essential health and safety requirements of :-

- The Machinery Directive 2006 / 42 / EC
- The Low voltage Directive 2006 / 95 / EC
- The requirements of the Electromagnetic Compatibility Directive 2004 / 108EC, 91 / 263 / EEC, 92 / 31 / EEC
- The General Safety of Machinery and food processing Standards applicable
- Materials and Articles intended to come into contact with food - Regulation (EC) No. 1935 / 2004
- Good manufacturing practice for Materials intended to come into contact with food - Regulation (EC) No. 2023 / 2006

Signed	
D. Osmundsen – Quality and Conformance Manager	

Date	
-------------	--

Machine FG Code.		Machine Serial No.	
-----------------------------	--	-------------------------------	--

A technical construction file for this machine is retained at the following address:

MONO EQUIPMENT
Queensway,
Swansea West Industrial Park,
Swansea
SA5 4EB
UK

MONO EQUIPMENT is a business name of **AFE GROUP Ltd**
Registered in England No.3872673 VAT registration No.923428136

Registered office: Unit 35,
Bryggen Road,
North Lynn Industrial Estate,
Kings Lynn Norfolk,
PE30 2HZ

ATTENTION

If the oven fails to heat up when first connected to a power supply or during use at any time, press the reset buttons located on the rear back panel.
(Do not remove the back panel)

If this fails to correct the situation, please contact your supplier.

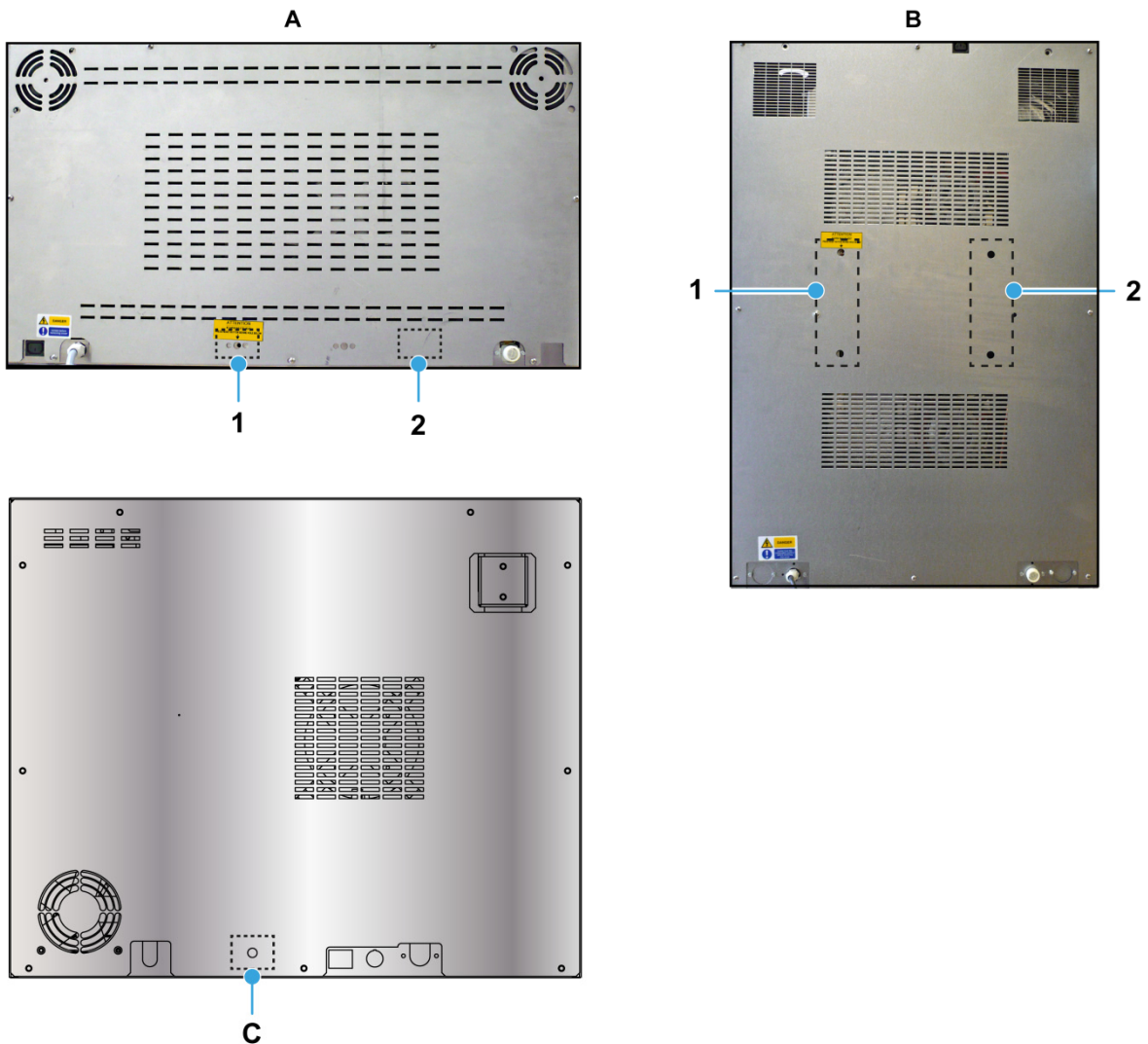

-
- A. Rear panel of 4/5-tray oven. The reset button hole can be at position 1 or 2 depending on the model
 - B. Rear panel of 10-tray oven. The reset button hole can be at position 1 or 2 depending on the model
 - C. Reset button hole on the rear panel of a 7-tray oven
-

Opening the double-catch door

1. Turn the handle **left** to release the catch halfway.
 - This step allows the steam and heat to escape.
2. Turn the handle **right** to release the door fully.
3. Open the door.

Note

- These instructions apply to both left-hand and right-hand ovens.
 - Close the door by pushing it shut.
-



Closed-door



Step 1. Turn left



Step 2. Turn right

Safety Symbols

The following safety symbols are used throughout this product documentation and manual (available at www.monoequip.com). Before using your new equipment, read the instruction manual carefully and pay special attention to information marked with the following symbols



WARNING

Indicates a hazardous situation which, if not avoided, could result in death or severe injury.



WARNING

Indicates a hazardous situation which, if not avoided, could result in death or severe injury.



CAUTION

Indicates a hazardous situation which, if not avoided, could result in minor or moderate injury.

Electrical Safety Notice



Electrical safety and advice regarding supplementary electrical protection

Commercial kitchens and food service areas are environments where electrical appliances may be located close to liquids or operate in and around damp conditions or where the restricted movement for installation and service is evident.

The installation and periodic inspection of the appliance should only be undertaken by a qualified, skilled, and competent electrician and connected to the correct power supply suitable for the load as stipulated by the appliance data label.

The electrical installation and connections should meet the necessary requirements of the local electrical wiring regulations and any safety guidelines.

We recommend:-

- Supplementary electrical protection with the use of a Residual Current Device (RCD)
- Fixed wiring appliances should also incorporate a locally situated switch disconnector to connect to, which is easily accessible for switching off and safe isolation purposes. The switch disconnector must meet the specification requirements of IEC 60947.

Your attention is drawn to:-

BS 7671:2018 – Guidance Note 8 – 8.13: Other locations of increased safety risk

It is recognised that there may be locations of increased risk of electrical shock other than those specifically addressed in Part 7 of BS 7671. Examples of such locations could include laundries where there are washing and drying machines in close proximity and water is present, and commercial kitchens with stainless steel units, where once again, water is present. Where, because of the perception of additional risks being likely, the installation designer decides that an installation or location warrants further protective measures, the options available includes:

- Automatic Disconnection of Supply (ADS) by means of a residual current device having a residual operating current not exceeding 30 mA;
- Supplementary protective equipotential bonding; and
- Reduction of maximum fault clearance time.

The provision of RCDs and supplementary bonding must be specified by the host organisation's appointed installation designer or electrical contractor and installed by a suitably qualified and competent electrician so as to comply with Regulations 419.2 and 544.2.



WARNING ▪ A 30mA-rated Type 'A' RCD must protect the supply to this machine.

Water Leak Safety Notice



WARNING

- Act immediately to get a water leak fixed by a suitably qualified engineer and prevent death or serious injury from electrocution.
-

It is essential to regularly check for any signs of a water leak from an oven installation. If there is evidence of a water leak, do not ignore it. Immediately report it to a manager or as applicable to your organisation.

Furthermore:

- Disconnect or completely isolate the oven from the electrical supply (see the **Isolation** section).
- Place an out-of-service notice on the oven.
- Contact your appointed service agent or MONO Equipment for assistance (see **Back Page**).

Ovens need to be maintained and serviced at appropriate intervals to help prevent water leaks from the internal plumbing and external hose connections. See the **General Maintenance** section.

General Maintenance Notice



WARNING

- This appliance must be maintained at regular intervals. The frequency of maintenance will depend upon your specific use and location. The maximum service interval should be 12 months.
 - Service and maintenance should only be undertaken by suitably qualified, trained, and competent engineers.
 - You must immediately report any damage or defect arising with the appliance.
 - Unsafe equipment is dangerous. Do not use the appliance. Isolate the power supply and contact **MONO** or your appointed service agent.
-

- Check for frayed or bare cables.
 - **Do not** use the machine if frayed or bare cables are visible.
- Follow cleaning instructions (see **Cleaning** on page 33).

Thank you for purchasing this MONO Bx Eco Connect oven.
“A combination of clean industrial design and the latest technology.”

The information in this quick start guide should get your purchase up and running without any problems. There is a complete Installation and Operating Manual available at www.monoequip.com. If you have a problem with your purchase, please contact the MONO Service Department at:

Mono Equipment Limited

Queensway, Swansea West Industrial Park, Swansea, SA5 4EB, UK

Tel. +44/0 1792 561234

Email: mono@monoequip.com

Please quote the serial number (**Figure 1**) of the oven when contacting the Mono Service Department. You can write the serial number on the front page.

Figure 1: Eco Connect oven features

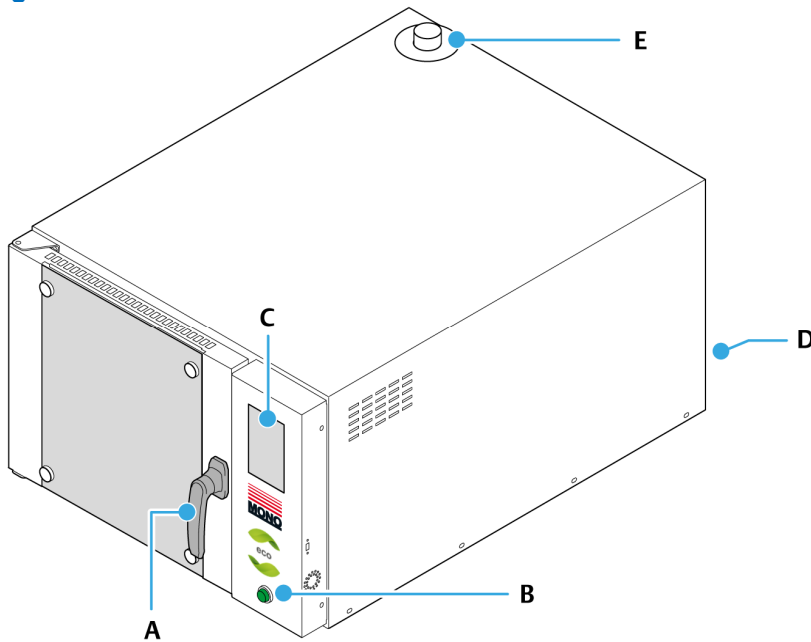

- A. Double-latch door handle – see page 4
- B. Power on/off switch
- C. Touchscreen
- D. Identification / Serial number plate.
- E. Damper flue – do not cover the flue

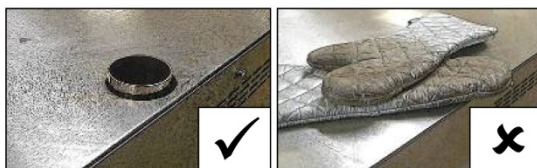

Specifications

Table 1: Technical specifications summary

	4/5-Tray				7-Tray	10-Tray		
	FG159	FG153	FG158	FG173	FG138	FG150	FG149	FG170
Tray size (mm)	-	400 x 600	600 x 400	400 x 800	400 x 600	-	-	-
Tray size (inches)	18 x 30	-	-	-	-	18 x 30	400 x 600	400 x 800
Distance between trays	93 mm	93 mm	84 mm			100 mm	100 mm	100 mm
Height (oven only)	525 mm	525 mm	570 mm	570 mm	655 mm	1170 mm	1170 mm	1170 mm
Height (oven + base)	-	-	-	-	1255 mm	1870 mm	1870 mm	1870 mm
Width	840 mm	780 mm	1000 mm	780 mm	780 mm	840 mm	780 mm	780 mm
Depth, door closed ⁽¹⁾	1269 mm	1103 mm	890 mm	1103 mm	1103 mm	1209 mm	1109 mm	1309 mm
Depth, door open ⁽¹⁾⁽²⁾	1828 mm	1610 mm	1610 mm	1810 mm	1610 mm	1770 mm	1609 mm	1809 mm
Weight (kg), approximate	165	115	110	160	125	290	250	262
Total power required (kW)	8.5	7.5	7.5	7.5	10	17	15	17
Water supply ⁽³⁾	■	■	■	■	■	■	■	■
Modularity	■	■	■	■	■	■	■	■
Landscape tray orientation			■					
Portrait tray orientation	■	■		■	■	■	■	■
Single (1) phase electrics ⁽⁴⁾	■	■	■					
Three (3) phase electrics ⁽⁴⁾	■	■	■	■	■	■	■	■
Steam function	■	■	■	■	■	■	■	■
Damp function	■	■	■	■	■	■	■	■
LED door lights	■	■	■	■	■	■	■	■
Stackable	■	■	■	■	⁽⁶⁾			
Display	7-inch HD TFT resistive touchscreen, portrait format							
Noise level (dB)	85	85	85	85	85	85	85	85
Variable fan speed	No	No	No	No	No	No	No	No
Optional extras								
Calcium treatment unit	□	□	□	□	□	□	□	□
Water condenser ⁽⁵⁾	□	□	□	□	□	□	□	□
Valance	□	□	□	□	□	□	□	□
Base unit ⁽⁷⁾	□	□	□	□	□			

⁽¹⁾ Includes the handle.

⁽²⁾ Excluding services. Allow room for water and electrical supply connections.

⁽³⁾ See the **Water** section on pages 12 and 14 for further information.

⁽⁴⁾ See **Electrical Specifications** on page 9 and **Power** on page 11 for further information.

⁽⁵⁾ See the **Installation and Operation Manual** (FG1BX-UK-MAN-0200) for further information.

⁽⁶⁾ Can be stacked with a 4/5-tray oven only.

⁽⁷⁾ Base units are 300 mm up to 920 mm high.

■ Available

□ Optional extra

Electrical specifications

Power supply



WARNING

- An electrical socket must be protected by a 30mA-rated Type ‘A’ Residual Current Device (RCD) before installation and commissioning of the oven.
- **Always** fit a wall-mounted isolator switch to isolate the oven from the electrical supply completely. The isolator must be visible, labelled clearly, and easily accessible by an operator.
- **Always** check the electrical requirements on the nameplate before connecting the power.

Table 2: Oven supply specifications

Oven		Electrical supply	Fused at	Total Power (kW)
4/5-Tray	18" x 26"	240 Vac (50 Hz), 1-phase	40 Amps	7.5
	26" x 18"			
	18" x 30"			
	40cm x 60cm			
	60cm x 40cm			
	40cm x 80cm			
	18" x 26"	380 Vac (50 Hz), 3-phase + neutral + earth	(Contact factory)	(Contact factory)
	26" x 18"			
	18" x 30"			
	40cm x 60cm			
	60cm x 40cm			
	40cm x 80cm			
	18" x 26"	415 Vac (50 Hz), 3-phase + neutral + earth	11 Amps per phase	7.5
	26" x 18"			
	40cm x 60cm			
60cm x 40cm				
40cm x 80cm				
18" x 30"	414 Vac (50 Hz), 3-phase + neutral + earth	12 Amps per phase	8.5	
7-Tray	40cm x 60cm	240 Vac (50 Hz), 1-phase	45 Amps	10
		380 Vac (50 Hz), 3-phase + neutral + earth	(Contact factory)	(Contact factory)
		415 Vac (50 Hz), 3-phase + neutral + earth	14 Amps per phase	10
10-Tray	18" x 26"	380 Vac (50 Hz), 3-phase + neutral + earth	(Contact factory)	(Contact factory)
	18" x 30"			
	40cm x 60cm			
	40cm x 80cm			
	18" x 26"	415 Vac (50 Hz), 3-phase + neutral + earth	32 Amps	17
	18" x 30"			
	40cm x 60cm			
40cm x 80cm				

Safety

The Bakery Manager or Supervisor must carry out daily safety checks. Bakery staff **must not**, under any circumstances, remove panels to access any part of the oven.

Only fully-trained and authorised persons are permitted to do any work on the oven. Authorised electricians must carry out all repairs and maintenance of electrical units. Always disconnect or isolate the power supply before starting any maintenance (i.e., opening panels) or cleaning work on the oven.

**WARNING**

- Before using the oven, check that:
 - All cover panels and pipe fittings are secure.
 - The door handles are not damaged.
 - If the oven is damaged or malfunctioning, stop using it.
 - Do not attempt any repairs.
 - Contact the MONO Service Department for advice.
 - All connections to the oven must comply with the statutory requirements of the country of installation.
 - Operate the oven only as described in this manual.
-

**WARNING**

- An electrical socket must be protected by a 30mA-rated Type 'A' Residual Current Device (RCD) before installation and commissioning of the oven.
 - Always fit a wall-mounted isolator to isolate the oven completely from the electrical supply. The isolator must be visible, labelled, and easily accessible by an operator.
 - Always check electrical requirements on the nameplate before connecting the power.
 - Never use the USB port to power or recharge electronic devices e.g., mobile phones. Incorrect usage causes damage to the oven and could result in a fire.
-

**CAUTION**

- Be aware of hot surfaces:
 - Always use oven gloves when loading or unloading the oven.
 - Allow time for the oven to cool down before cleaning it. To prevent door glass from shattering, do not clean the oven glass when hot.
 - While the oven is in operation (and for some time after use), it is inadvisable to touch the oven window or the surrounds because of conducted heat.
 - The oven owner is legally obliged to instruct staff on these safety points and the safe operation of the oven. Therefore, these instructions should not be removed from the working area.
 - Do not store items on top of or behind the oven.
 - Only use the oven for baking bread, pastries, and cakes. Contact MONO Equipment for other product-making machines.
 - No unauthorised modifications to the oven are permitted. Only use MONO spare parts.
-

Installation

Power



WARNING

- An electrical socket must be protected by a 30mA-rated Type 'A' Residual Current Device (RCD) before installation and commissioning of the oven.
- **Always** fit a wall-mounted isolator switch to isolate the oven from the electrical supply completely. The isolator must be visible, labelled clearly, and easily accessible by an operator.
- **Always** check the electrical requirements on the nameplate before connecting the power.

Figure 2: Main power supply connections

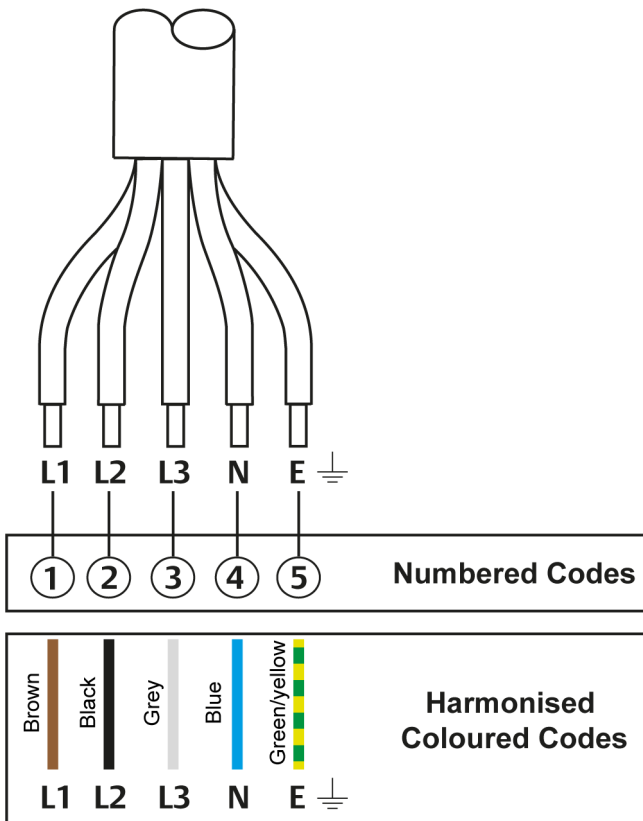

NOTE

- L2 and L3 are for three-phase installations only.
- See the **Specifications** section for electrical specifications.

Water

Connect to a suitable water supply making sure that the pipes are flushed out to remove all foreign bodies, i.e. flux or solder. Customers operating a BX oven in a hard water area must ensure that an efficient water-softening device protects the water supply to the equipment. It is the customers' responsibility to install and maintain an adequate water supply to the oven, which should comply with local water regulations.

- The oven is supplied with a one-metre flexible hose – ¾-inch BSP connections (both ends).
- Water pressure requirements: 2 to 4 bar
 - Domestic pressure is usually within this parameter.
- Water conditioning unit advised.
- No drain is required (unless fitting a condenser).

Ventilation

It is the customers' sole responsibility to arrange adequate ventilation. It should be sufficient to ensure water does not condense on or around the oven.

- Allow a 50 mm gap at the sides and rear of this oven.
- Chimneys and evacuation ducts fitted above mono ovens should be insulated.

Before use

In the interests of hygiene, we strongly recommend that, before using the oven for the first time, you wipe the inside of the oven and all accessories thoroughly with a clean cloth soaked in warm soapy water. Although the utmost care is taken during assembly and pre-delivery inspection, there is always a possibility of residue contaminating the first bake if this is not done.

- Ensure that the locking casters on the base unit (if supplied) are locked into position.

Safety

- Review the safety information on **page 10**.
- Allow sufficient space for the oven door to open fully and easy loading/unloading of product trays without people coming in contact with hot surfaces.
- Racks should be available to allow cooked products to cool safely.
- Oven gloves should be available at all times.

Ambient working temperatures

Ambient working temperatures for electrical components, such as solenoid switches, circuit breakers, and motors, **should not exceed 40 °C (115 °F)**. Manufacturers of these, and other electrical components, advise that any ambient temperature above 40 °C (115 °F) affects the functionality of the components, and any related guarantees become void. For example, motors are not sufficiently cooled, contactor efficiency is seriously impaired, and electronic components shut down.

It is the customers' sole responsibility to arrange for adequate ventilation. Any component malfunctioning during the guarantee period found to have been subject to excessive humidity or ambient working temperature above 40 °C (115 °F) will not be covered by the component manufacturer guarantee or MONO's product warranty.

Isolation

Electrical supply

To stop the oven **in an emergency**, switch off the electricity at the wall isolator.

Water supply

In an emergency, shut off the water supply to stacked ovens by closing the shut-off valves (**Figure 3**).

Figure 3: View of rear connections on a MONO Eco Convection Oven

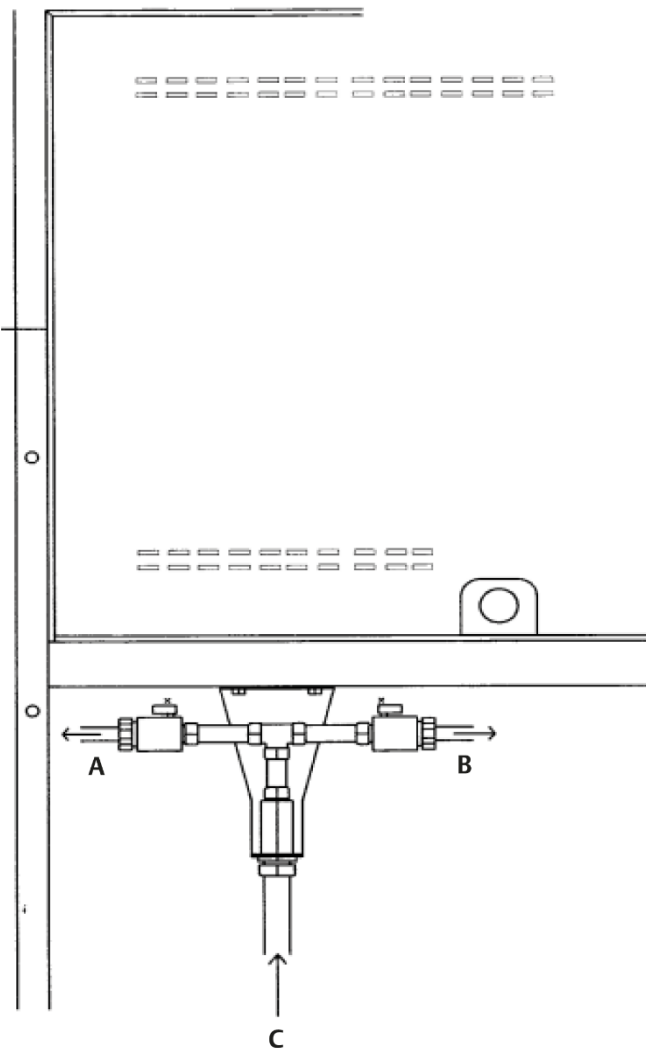

Turn the appropriate valve 90° anti-clockwise (↺) to turn off the water supply.

- A. Top oven supply
- B. Bottom oven supply
- C. Supply from water filter

Touchscreen Operations

Operations are performed by touching an area of the screen, bringing up the next information panel, or activating a function.



CAUTION ■ Do not use excessive force to operate the touchscreen panel.

Figure 4: Main screen

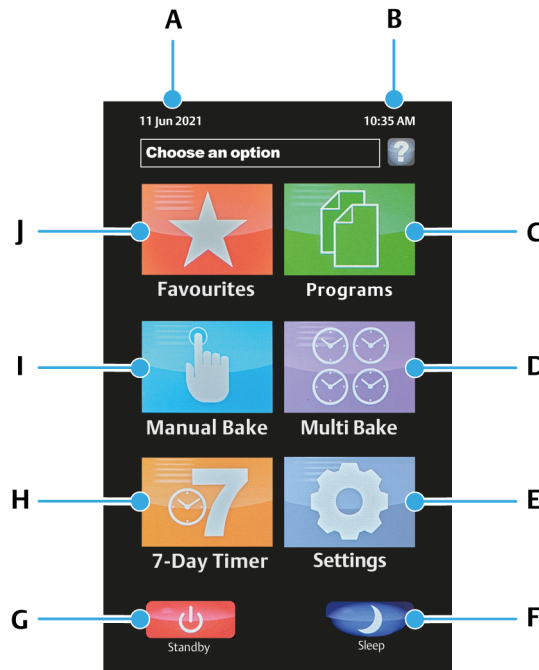

Callout	Function	Purpose of the function
A	Date	It shows the current date.
B	Time	It shows the current time.
C	Programs.	Access to saved baking recipe programs. Creation of programs.
D	Multi Bake	Creation of up to four simultaneous bakes with different timings.
E	Settings	Access to oven settings.
F	Sleep	Sleep mode – see page 32.
G	Standby	Standby mode – see page 32.
H	7-Day Timer	Create an oven on/off schedule for every day of the week.
I	Manual Bake	Baking using manual controls.
J	Favourites	Easy selection of most frequently used baking recipe programs.

NOTE: The images are for illustration purposes and may differ from your oven.

Starting and operating using ready-made recipes (programs)

1. Ensure the power and water supplies are safely connected to the oven (see **Installation** on page 7).
2. If the display (A) is blank, press the green power button (B) at the bottom of the front panel.
The oven goes through a boot-up sequence. Please wait.

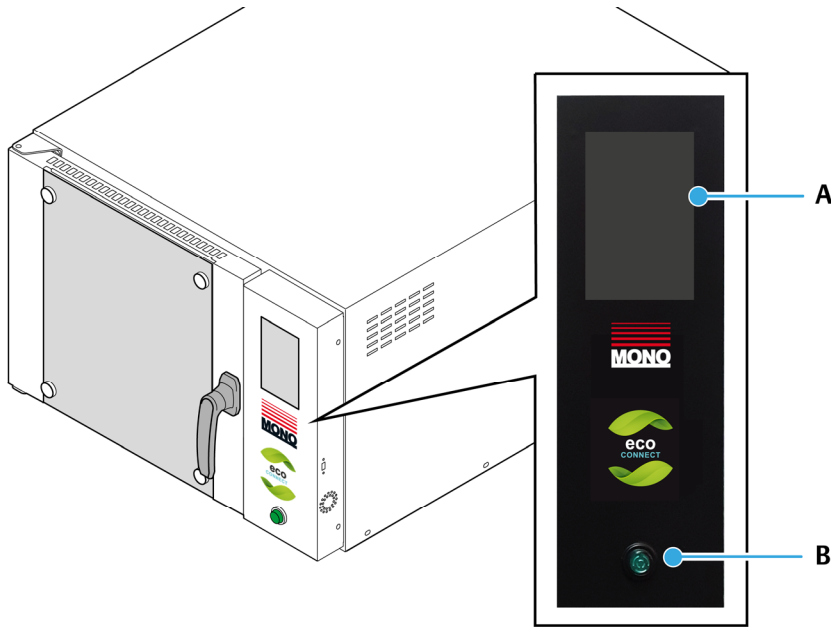

NOTE

The images are for illustration purposes and may differ from your oven.

3. When a start-screen (wallpaper) appears, touch the screen anywhere to display the main screen.

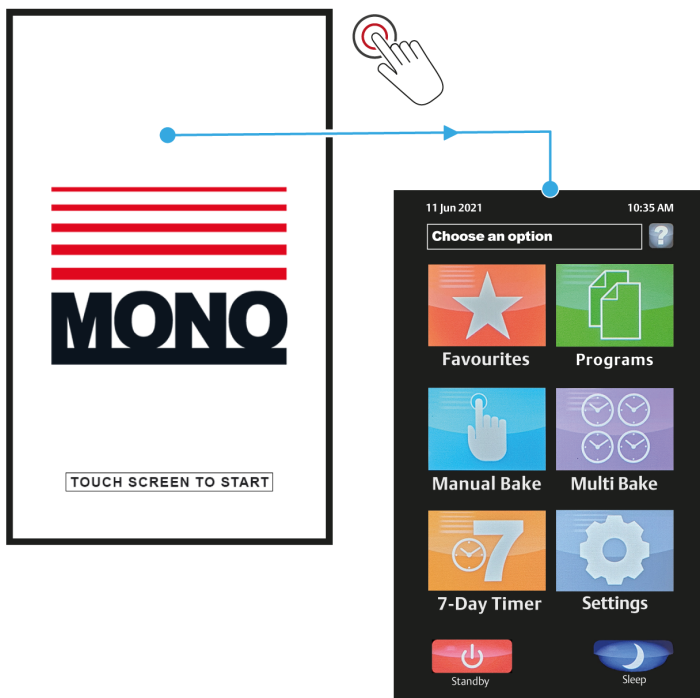

4. Touch the **Programs** tile on the **Choose an option** screen.

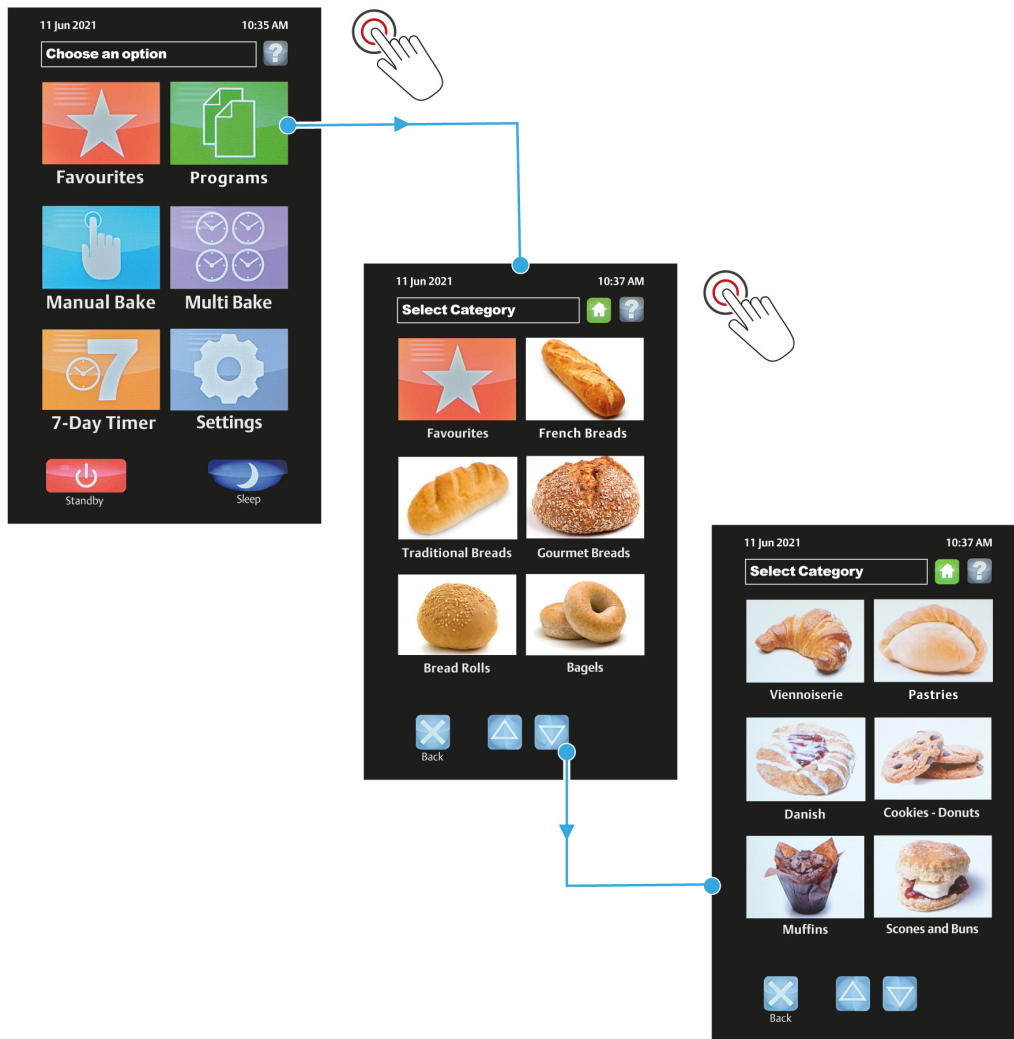

5. Select a product category.

- (a) Touch the scroll up and down buttons to change category pages.
 - The **Back** button returns the display to show the **Choose an option** screen.
- (b) Touch the tile of a product type you require (e.g., muffins).
 - A list of recipes then displays for that product type.

NOTE

Tiles typically show a product group image or a program number group, depending on how the oven was factory configured. See the complete Installation and Operation Manual on www.monoequip.com for how to do an update using the USB flash drive (if supported).

6. Select a baking recipe

- (a) Touch the baking recipe required (e.g., blueberry muffins).
- (b) If prompted, select **Full Load** or **Half Load** depending on the oven loading.

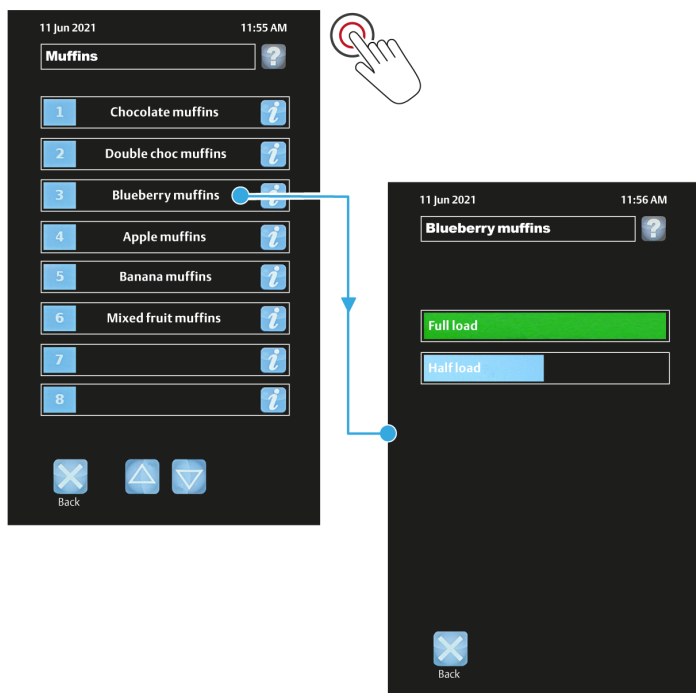

7. A baking screen now appears.
 - (a) Wait while the oven heats up. A **Heating** message flashes on the screen.
 - (b) Load the oven with products when **Ready** flashes on the screen.
 - (c) Touch **Start** to begin baking.



NOTE

To maintain the heat in the oven, do not leave the door open for longer than needed. The actual oven temperature fluctuates during a bake – this is normal and not an oven fault.

- 8. During a bake, two actions can be performed.
 - Touch the **View** button to view settings during a bake.
 - Touch the numbered square (e.g., **2**) to view the settings for different baking phases.
 - The **Cancel** button displays the baking screen again for the present baking phase.
 - Touch the **Stop** button to stop a bake at any time.



- 9. When a buzzer sounds to indicate the bake is complete, two actions can be performed:
 - Press the **Stop** button to finish the bake, or
 - Press the **+2 mins** to continue the bake for a further two minutes.
 - This time extension is adjustable in the **Settings** menu.

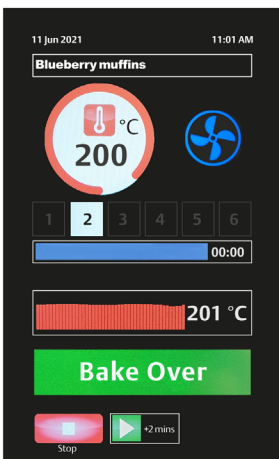

- 10. Remove the trays and close the door to preserve the heat.

Manual bake (no program mode)

1. Touch the **Manual Bake** tile.
2. Set the temperature required.
 - (a) Touch the **Temperature** circle.
 - (b) Key in the temperature required.
 - (c) Touch the **OK** (✓) button.

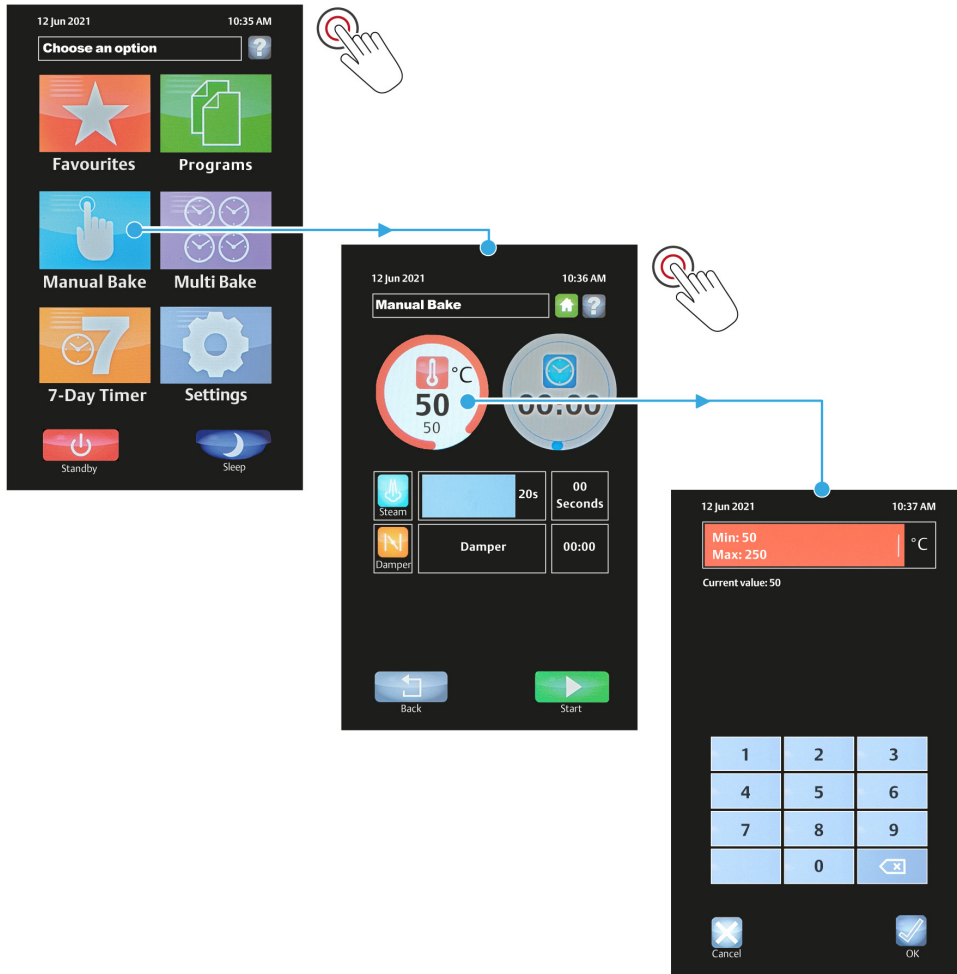



3. Set the baking time required.
 - (a) Touch the **Timer** circle.
 - (b) Use the up and down keys to edit the time.
 - (c) Touch the **OK** (✓) button.

NOTE

When the time is **00:00**, and the **Start** button is touched, the timer counts upwards until the bake is stopped. If the screen shows **HEATING**, wait until the oven is up to temperature before touching **Start**.

4. Load the oven with products and touch **Start**.
 - The timer counts down from a set time to **00:00** or counts upwards if no time set.
5. Use the steam and damper functions when needed.

Button	Function	Purpose of the function
	Steam	After touching Start , touch the Steam button for the number of seconds wanted and release.
	Damper	Touch the Damper button to open the damper, and touch again to close. (The button changes colour when the damper is open).

6. When the timer is counting down and reaches **00:00**, a sounder is heard. A **BAKE OVER** message also flashes on the screen. Touch **Stop** to stop the sounder.
7. The bake can be stopped at any time by touching **Stop**.

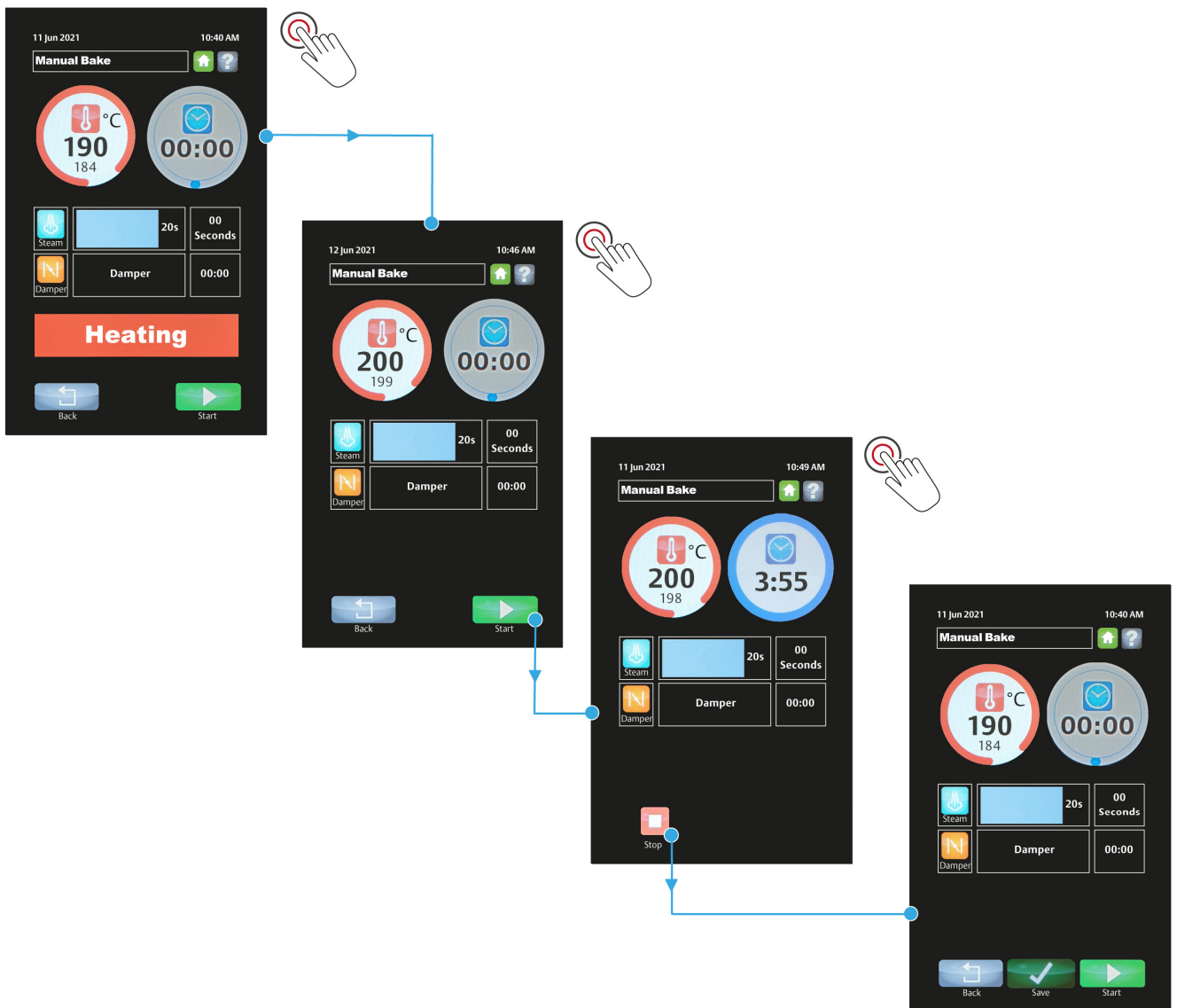

Setting the time and date

1. Touch the **Settings** tile.
2. Enter the **Oven Settings** password, and then touch the **OK** (✓) button.

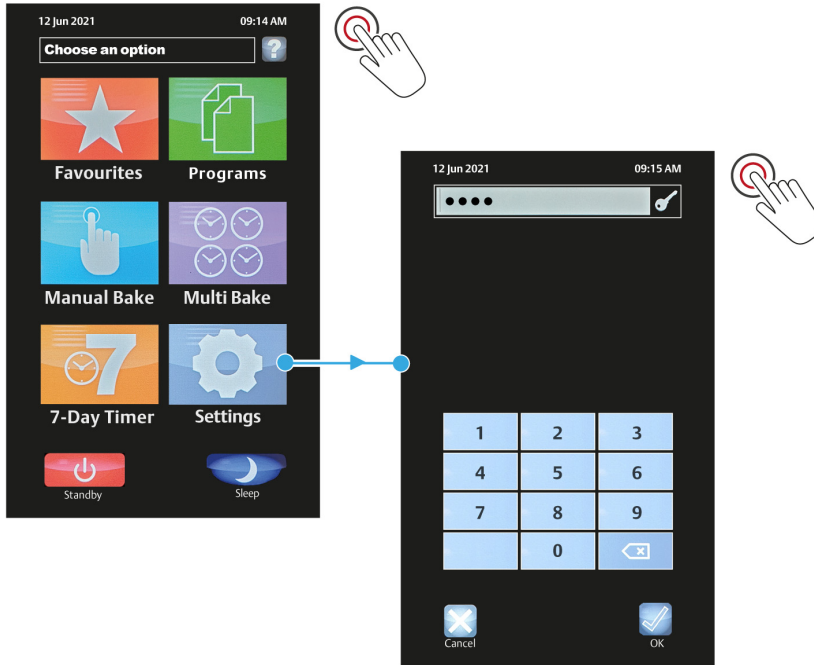

NOTE

Default passwords for the various access levels are in the Installation and Operating Manual. However, for security reasons, the passwords section may have been removed.

3. Touch the **Time & Date** box.

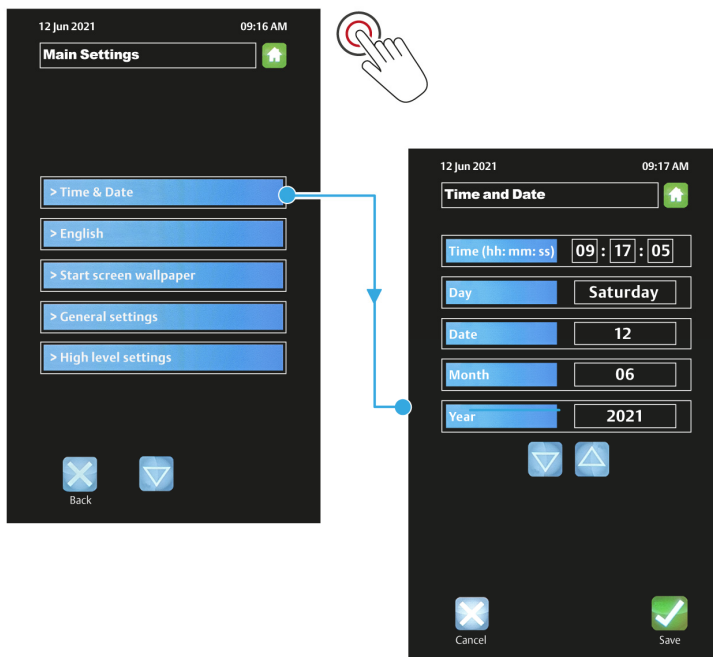

4. Touch the item that needs adjusting, and then use the up or down arrows as required.
 - The time, date, month, and year can be adjusted.
 - The day is not adjustable – it automatically updates using the date, month, and year.



5. Touch **Save** (✓) to confirm new settings.
6. Touch the **Home** button to return to the main screen.

NOTE

See the Installation and Operating Manual for complete information about the main oven settings.

Setting up a new program

1. Touch the **Programs** tile.
2. Choose the category or number group required.

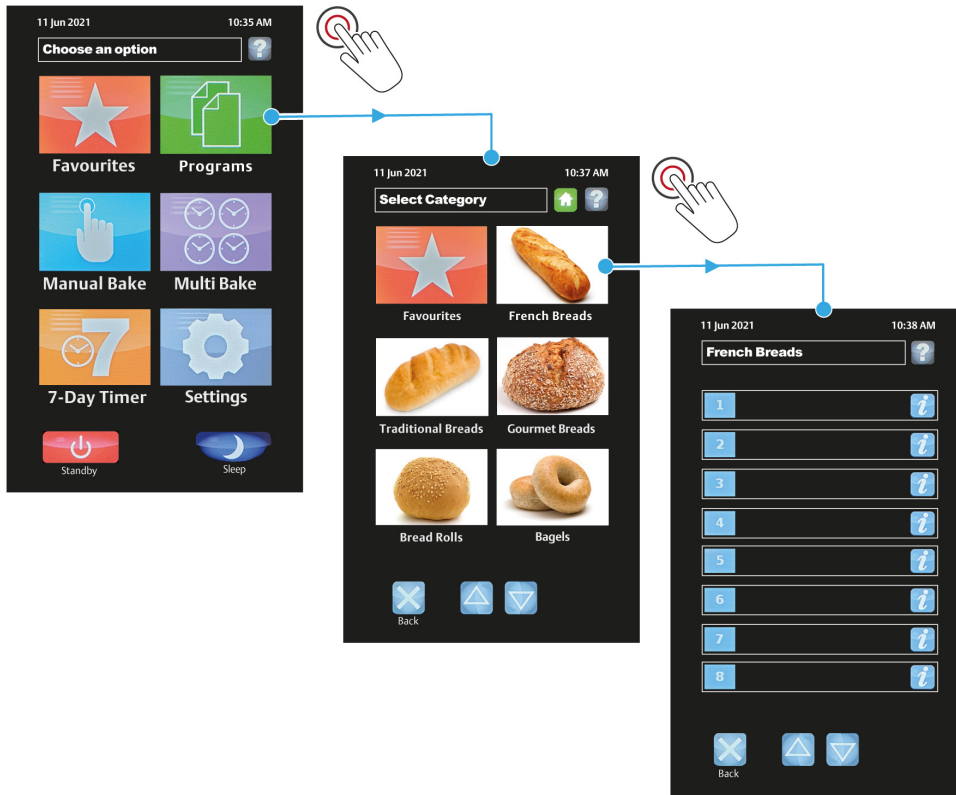

3. Touch the **Info** (i) button of the next free recipe slot.
4. Touch the **Options** button.

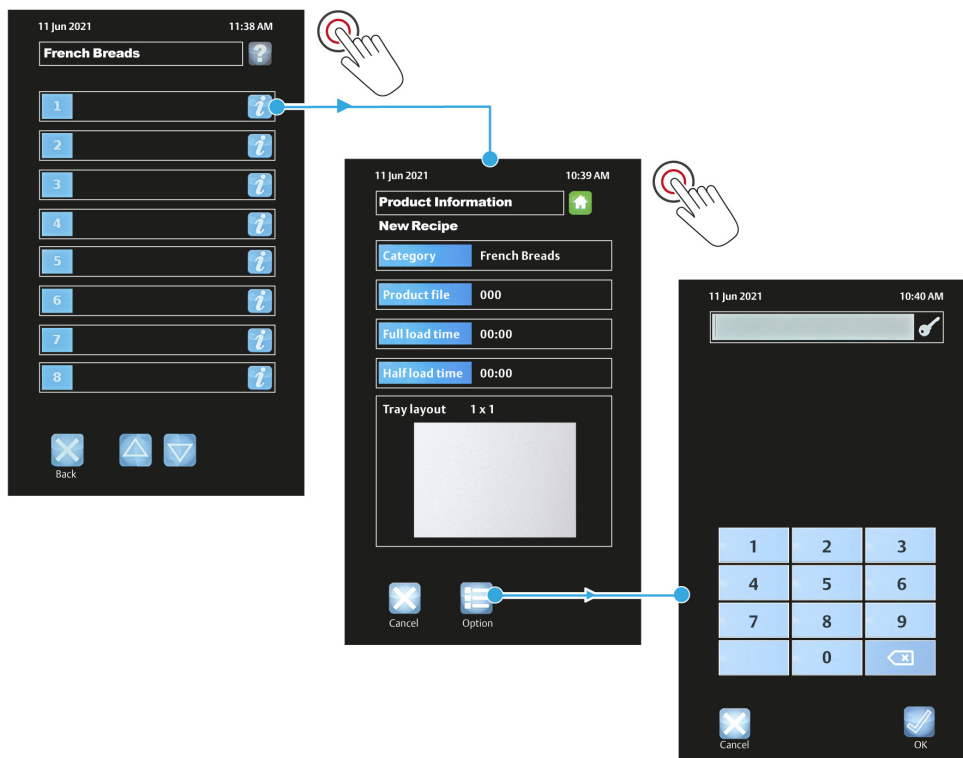

- 5. Enter the **Operator** password and touch **OK**.

NOTE

Default passwords for the various access levels are in the Installation and Operating Manual. However, for security reasons, the passwords section may have been removed.

- 6. Create a product recipe.
 - (a) Choose the **Full-load** or **Half-load** option.
 - (b) Select a baking phase number (i.e., **1**).
 - (c) Touch an item:
 - Temperature, Steam time, Phase time, Fan cycles, Fan dwell, Damper delay, or Power level.
 - (d) Adjust the setting by typing the amount or, if they appear, using the up and down keys.
 - (e) Touch **OK** to confirm the setting value.
 - (f) Repeat steps (c) to (e) for each item needed in that baking phase.
 - (g) If required, select the next baking phase (i.e. touch **2**) and adjust the items in the same way.
 - (h) Touch **Save** to confirm the completed recipe settings.

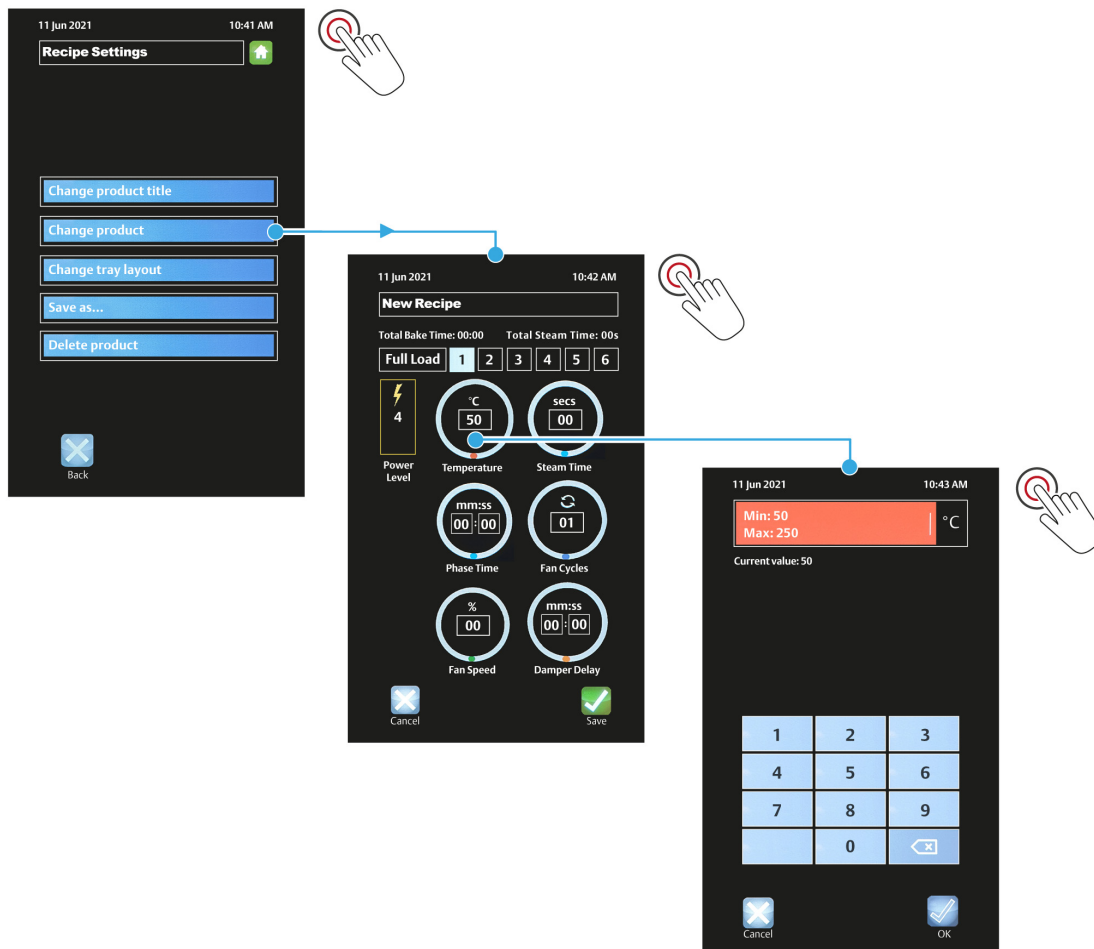

- 7. Edit a tray layout for the new product recipe.
 - (a) Touch the **Change tray layout** box
 - (b) Touch the **W** (width) box to highlight it.
 - (c) Use the up or down arrow key to change quantity across the tray.
 - (d) Touch the **D** (depth) box to highlight it.
 - (e) Use the up or down arrow key to change quantity down the tray.
 - (f) Touch **Save** to confirm the tray layout.

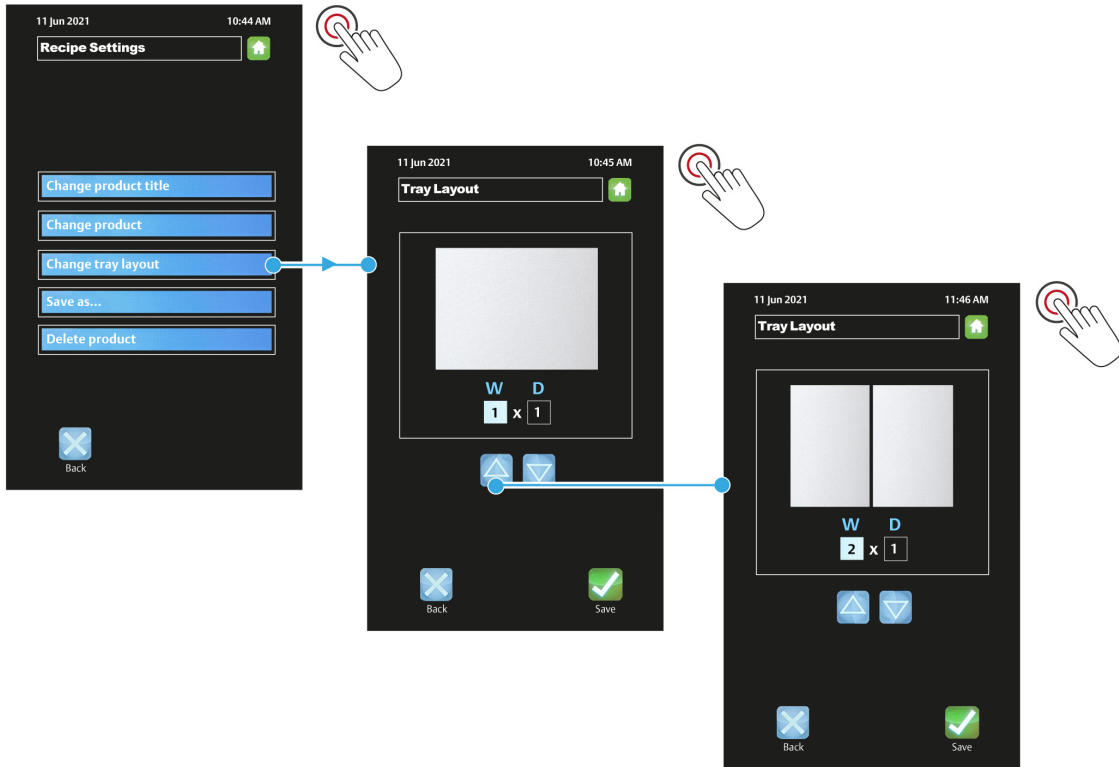

- 8. Add the new product recipe to the list.
 - (a) Touch the **Save as...** box
 - (b) Input a name for the product recipe, and then touch **OK**.

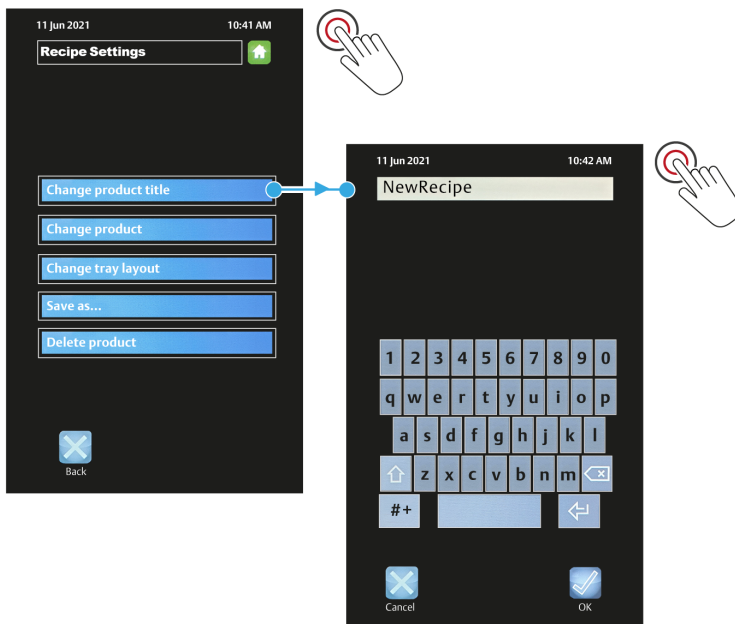

- 9. Touch the **Home** button to finish.

Multi bake operation

1. Touch the **Multi Bake** tile.

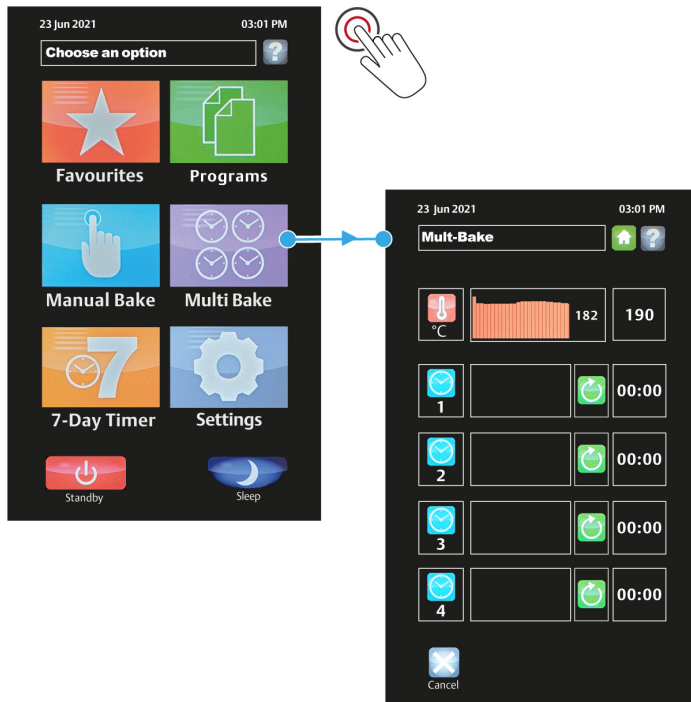

2. Set a timer
 - (a) Touch a time-setting box.
 - (b) Adjust the bake time required using up and down keys.
 - (c) Touch the **OK** (✓) button.
 - (d) Repeat steps (a) to (c) to set different bake time sequences, if required.

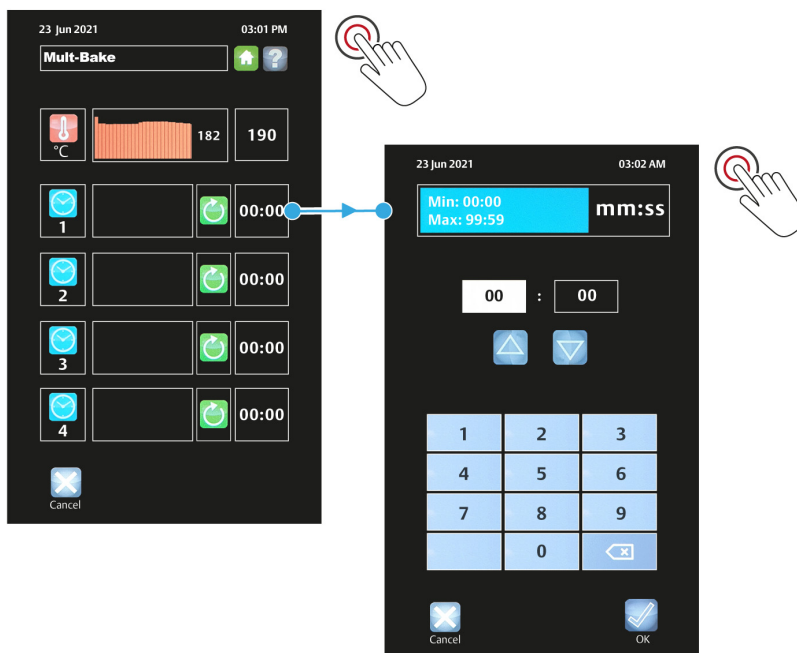

- 3. Set the temperature for the bakes
 - (a) Touch a heat-setting box.
 - (b) Type in temperature required.
 - (c) Touch **OK** to confirm the temperature.

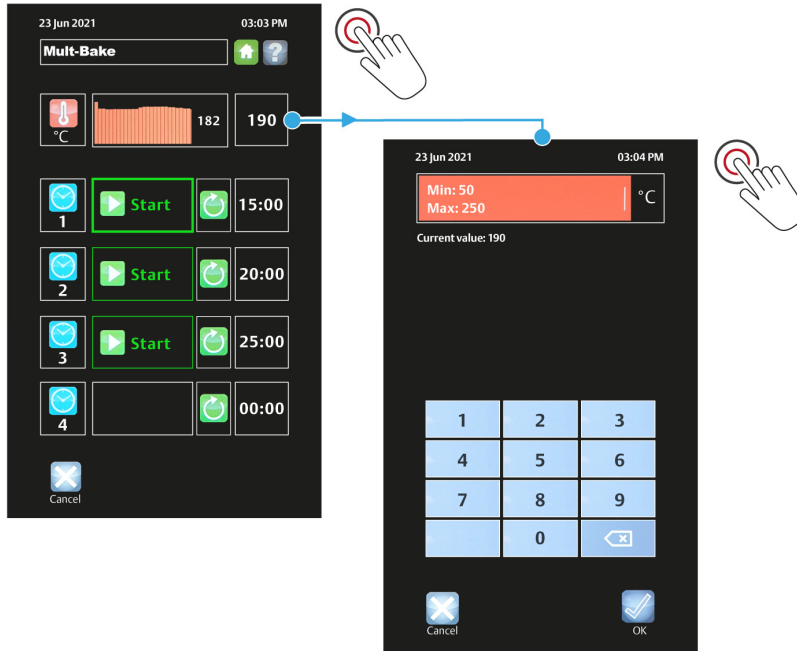

- 4. Start the bake.
 - (a) Load the oven.
 - (b) Touch the **Start** button (next to the bake time required).

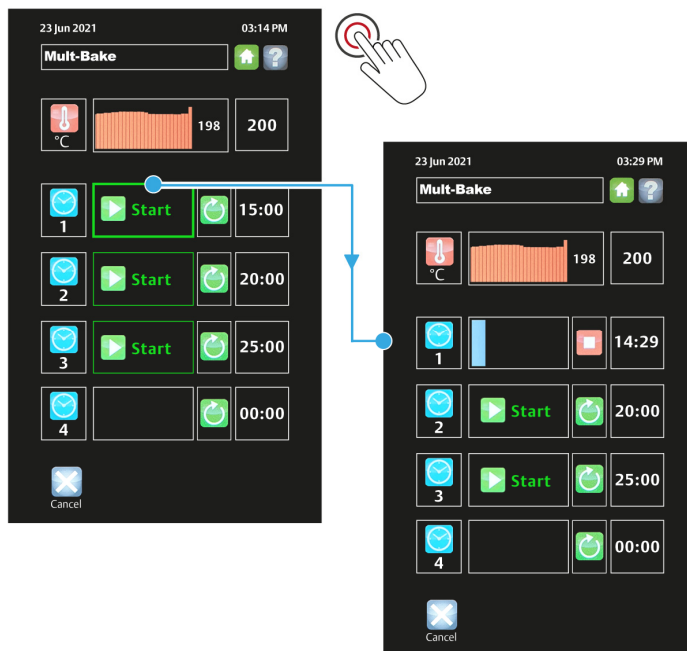

- 9. The panel flashes when a bake finishes, and the oven emits a beep-beep alarm.
Touch the **Stop** button next to the **00:00** time.

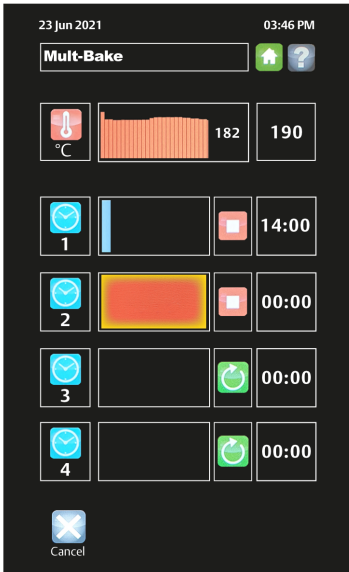

- 10. Touch the **Stop** button at any time to end a bake, and the same settings are useable again.

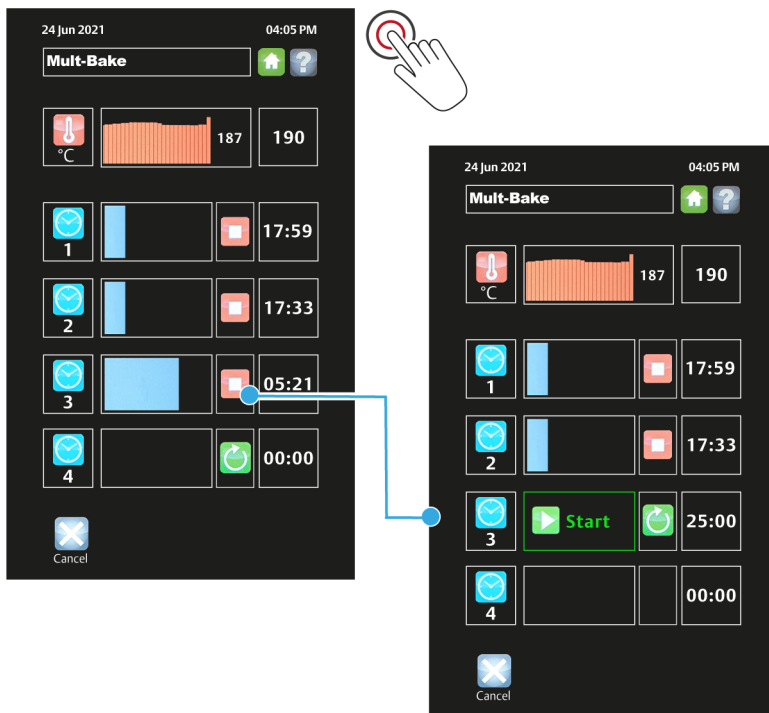

NOTE

The settings are reusable until the **Cancel** button is touched. Then, cancelling clears the settings for the next time the Multi-bake function is needed.

7-Day Timer

While the oven is in standby mode, it can heat up at pre-set times every day as required.

1. Touch the **7 Day Timer** tile.



2. Touch the day an oven operation is required (e.g., **Tuesday**).
3. Set the **On-time**.
 - (a) Touch the **On** tile of a time panel.
 - (b) Set the time using the keys in the pop-up box that appears, and then touch **Save (A)**.

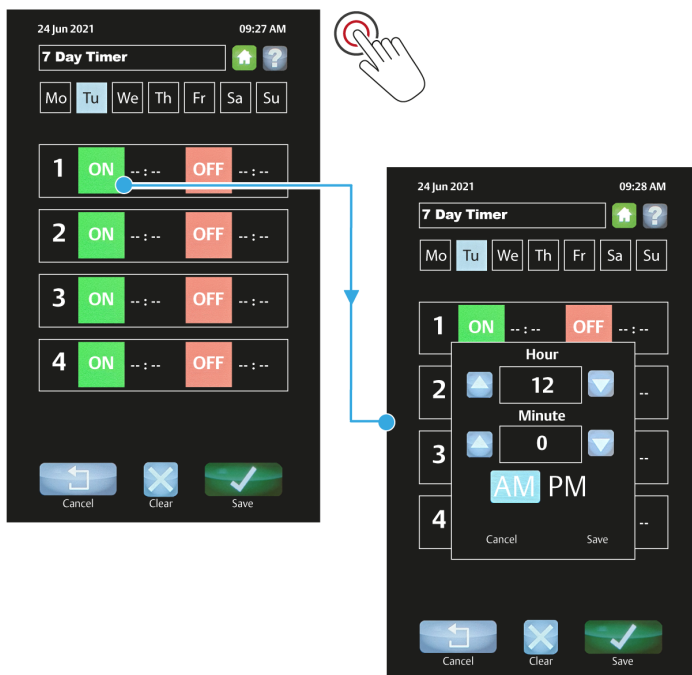

4. Set the **Off-time**.

- (a) Touch the **Off** tile of a time panel.
- (b) Set the time using the keys in the box that appears, and then touch **Save (A)**.

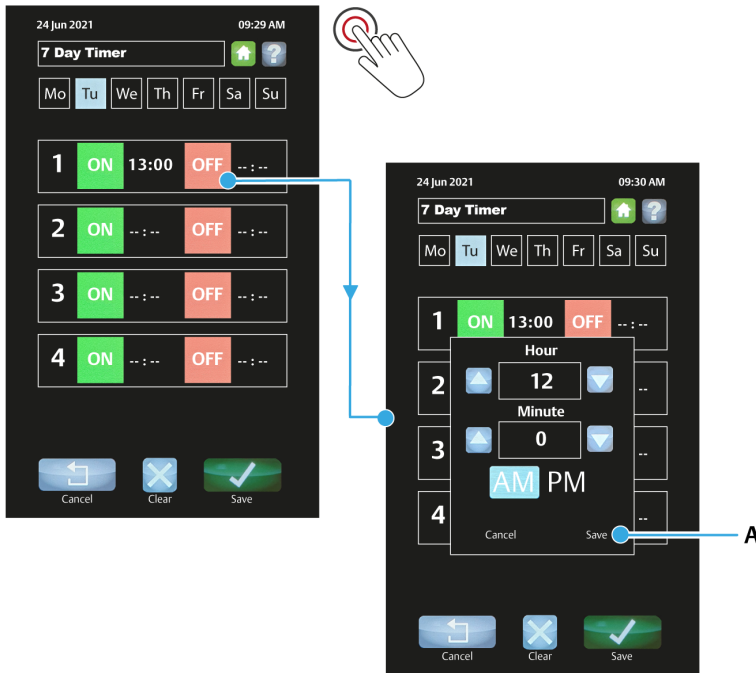

5. Touch **Save (B)** to confirm the 7-day timer settings.

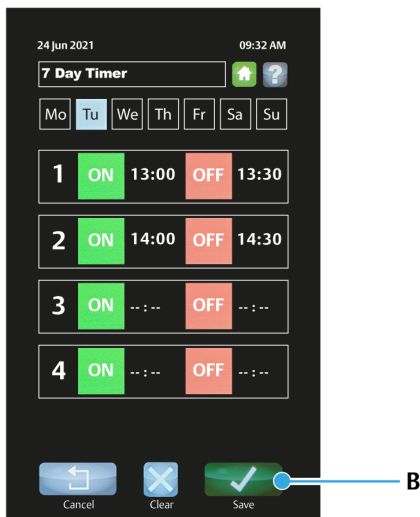

NOTE

Remember to leave the oven in **Standby mode** for this 7-day timer function to work.

Putting the oven into Standby mode

The **Standby** button turns the oven off until the screen is touched again.



Putting the oven into Sleep mode

If enabled in the oven settings, the **Sleep** button instructs the oven to maintain temperature to a pre-set value.

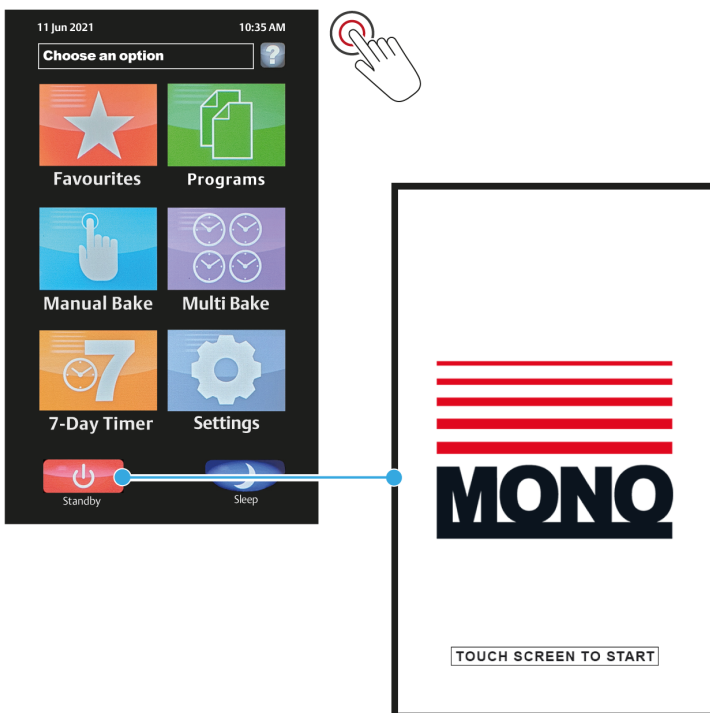

Cleaning



WARNING

- Isolate the oven from the mains supply and allow time to cool before cleaning.



WARNING

- Do not remove the rear panelling inside the oven. That panel provides access to the fan assembly, which is not safety interlocked and could cause serious injury.



CAUTION

- Clean the equipment daily using approved chloride-free cleaning fluid.
- Take care that water does not enter the control panel or rear-access panel. Never use a pressure washer or water hose to clean the oven.

Daily cleaning instructions

General instructions

1. Sweep any debris out of the oven **after** it has been allowed to cool.
Note: Cooling down could take several hours. Use a vacuum cleaner with metal attachments (i.e. able to take the heat), if available.
2. Brush down and wipe the oven front, back and sides with a damp cloth.
3. Spot clean outside with a damp cloth, soaked in a solution of mild detergent and hot water.
NOTE: Pay particular attention to ensure excess water is not applied around the area of the electrical panels.

Weekly cleaning instructions

General instructions

1. Complete the daily cleaning procedure, as above.
2. Clean any burnt-on debris by careful use of a proprietary oven cleaner, carefully following the manufacturer's instructions. Do not allow the oven cleaner to get onto the control panel.
3. Use a nylon brush to scrub the cabinet wheels (if fitted) with a mild detergent and hot water.
NOTE: Using too much water eventually rusts the metalwork.

Periodic cleaning instructions

Door glass cleaning instructions

The inner door glass is hinged to enable the cleaning of inner surfaces.

1. Undo the two screws shown in **Figure 5**.
2. Swing the inner glass panel away from the door (**Figure 6**).
3. Clean the inner surfaces of the door glass using a suitable glass cleaner.
4. Re-secure the inner glass with the two screws when finished cleaning.

Figure 5: Location of the two screws for releasing the inner glass

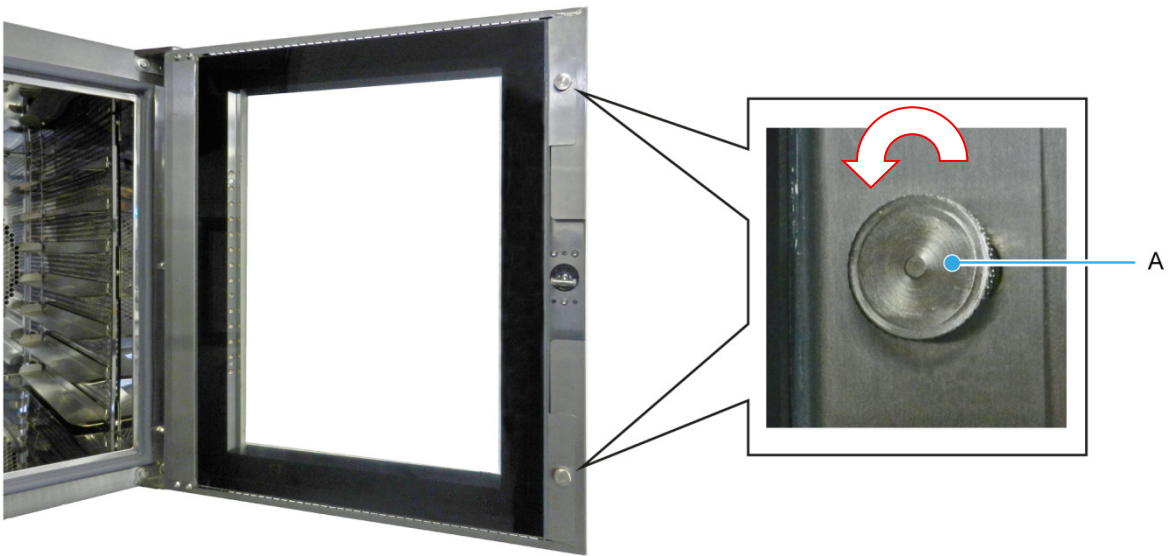

A. Undo the two screws to release the inner glass for cleaning.

Figure 6: Inner glass panel moved away from the door



(Intentional Empty Page)

If a fault arises, please do not hesitate to contact the
Customer Service Department, quoting the **machine serial number**
on the silver information plate of the machine and on the front cover of this manual

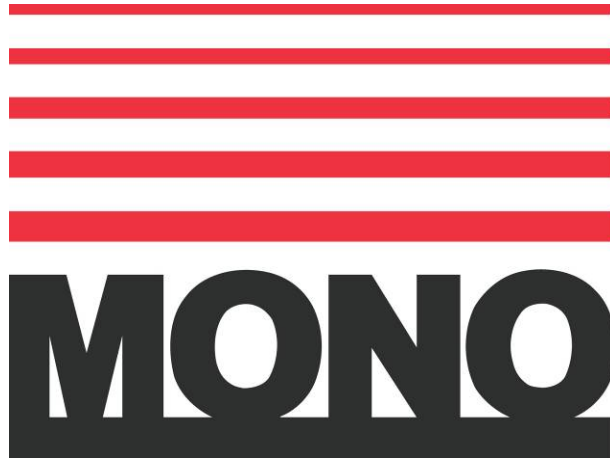

Mono Equipment Limited

Queensway
Swansea West Industrial Estate
Swansea, SA5 4EB, UK

spares@monoequip.com
www.monoequip.com

Tel. 01792 561234
Spares +44/0 1792 564039
Fax. 01792 561016

Oven Disposal

Care should be taken when the machine comes to the end of its working life. All parts should be disposed of in the appropriate place, either by recycling or other means of disposal that complies with local regulations.

(In the United Kingdom, the Environmental Protection Act 1990 applies.)