

Fan Assisted Deck Oven

EN Installation and Operation



Product Version

- Fan assisted baking
- Double-depth fixed decks
- 3-tray wide x 2-tray deep
- ECO touch control
- UK specifications

Oven Serial Number

Oven Code

FG246T-B483L

FG246T-B483R



Thank you

Thank you for purchasing MONO's Fan Assisted Deck Oven.

Before using your new oven for the very first time, please read and familiarise yourself with the contents of this User Manual and keep it handy for future reference.

If you have any queries regarding your oven, please contact MONO Equipment Limited directly:

- +44 (0)1792 561234
- sales@monoequip.com
- spares@monoequip.com
- techsupport@monoequip.com

We wish you the very best of success with your new professional Fan Assisted Deck Oven.

Happy baking!

The MONO Team



Safety Symbols

The following safety symbols are used throughout this user manual (available electronically at [MonoEquip.com](https://www.monoequip.com)). Before using your new equipment, read the user manual carefully and pay special attention to information marked with the following symbols.

**DANGER**

- Indicates an immediate hazard with a high risk which, if not avoided, will result in death or serious physical injury.

**WARNING**

- Indicates a potential hazard with a medium risk which, if not avoided, could result in death or serious physical injury.

**CAUTION**

- Indicates a hazard with a low risk which, if not avoided, could result in minor or moderate physical injury.
-

Electrical Safety Notice

Advice regarding supplementary electrical protection

Commercial kitchens and food service areas are environments where electrical appliances may be located close to liquids, operate in and around damp conditions or where restricted movement for installation and service is evident.

The appliance installation and periodic inspection should only be undertaken by a qualified, skilled, and competent electrician and connected to the correct power supply suitable for the load as stipulated by the appliance data label.

The electrical installation and connections should meet the mandatory requirements of the local electrical wiring regulations and any safety guidelines.

We recommend:

- Supplementary electrical protection with the use of a residual current device (RCD)
- Fixed wiring appliances incorporate a locally situated switch disconnecter to connect to, which is easily accessible for switching off and safe isolation purposes. The switch disconnecter must meet the specification requirements of IEC 60947.

Your attention is drawn to the following: BS 7671:2018 – Guidance Note 8 – 8.13: Other locations of increased risk

It is recognised that there may be locations of increased risk of electrical shock other than those specifically addressed in Part 7 of BS 7671. Examples of such locations could include laundries where there are washing and drying machines in close proximity, and water is present, and commercial kitchens with stainless steel units, where once again, water is present. Where, because of the perception of additional risks being likely, the installation designer decides that an installation or location warrants further protective measures, the options available include:

- Automatic Disconnection of Supply (ADS) by means of a residual current device having a residual operating current not exceeding 30 mA;
- Supplementary protective equipotential bonding; and
- Reduction of maximum fault clearance time.

The provision of RCDs and supplementary bonding must be specified by the host organisation's appointed installation designer or electrical contractor and installed by a suitably qualified and competent electrician so as to comply with Regulations 419.2 and 544.2.



WARNING

- The supply to this machine must be protected by a 30mA-rated Type A Residual Current Device (RCD).
- Always fit a wall-mountable isolator switch to isolate the oven from the electrical supply completely. The isolator must be visible, labelled as an emergency shut-down device, and easily accessible.

Water Leak Safety Notice

**WARNING**

Take immediate action to get a water leak fixed and prevent death or serious injury from electrocution.

It is essential to regularly check for any signs of a water leak from an oven installation. If there is evidence of a water leak, do not ignore it. Immediately report it to a manager or as applicable to your organisation.

Furthermore:

- Disconnect or completely isolate the oven from the electrical supply.
- Place an out-of-service notice on the oven.
- Contact your oven supplier or MONO Equipment Limited for technical assistance.

Ovens must be maintained and serviced at appropriate intervals to ensure the oven operates at optimum levels.

General Notices



CAUTION

■ Users with Implantable Cardioverter Defibrillators and Pacemakers

- Several common types of devices and machinery may interfere with implantable cardioverter defibrillators (ICDs) and pacemakers, including mobile phones, headphones, radios, machinery, and magnets.
- The electromagnetic waves generated by these devices can keep your ICD or pacemaker from functioning correctly. Try to avoid them, or at least minimise your exposure to them.
- Your healthcare professional can advise you about specific devices and machinery to avoid.



NOTICES

■ Warranty information

- Ambient working temperatures for electrical components, such as solenoid switches, circuit breakers and motors, should not exceed 40 °C (115 °F). Manufacturers of these, and other electrical components, advise that any ambient temperature above this affects the functionality of the components. Any related guarantees become void.
- It is the owners' responsibility to ensure adequate ventilation is provided. Any component malfunctioning during the guarantee period found to have been subjected to excessive humidity or ambient working temperatures is not covered by the component manufacturer's or MONO Equipment's product warranty.
- Failure to adhere to the cleaning and maintenance instructions detailed in this User Manual also could affect the warranty of this machine.
- Visit the [MONO Parts and Labour Warranty page](#) for further information.

■ Continuous improvements

- As it is our policy to improve our machines continuously, we reserve the right to change specifications without prior notice.

■ Engineers/Electricians-only sections of the User Manual

- Technical sections of this User Manual are for suitably qualified and experienced persons (SQEP) only. Customers must never make any modifications or repairs to MONO's machines.

Declaration of Conformity Certificate



Declaration of Conformity



We the manufacturer: **MONO EQUIPMENT**
 Queensway,
 Swansea West
 Industrial Park,
 Swansea
 SA5 4EB
 UK

Machine:

FG Code:

Serial No:

Hereby declare that this machine conforms with and complies with the following directives:

- The Machine Directive **2006/42/EC**
- The Low Voltage Directive **2014/35/EC**
- The Electromagnetic Compatibility Directive 2014/30/EU Incorporating Standards **EN 55014-1:2017/A11:2022 & EN 55014-2:1997+A1:2001+A2:2008**
- The General Safety of Machinery and Food Processing Standards
- Materials and Articles Intended to Come into Contact with Food – Regulation (EC) No. **1935/2004**
- Good Manufacturing Practices (GMP) for Materials Intended to Come into Contact with Food
 - Regulation (EC) No. **2023/2006**

A technical construction file for this machine is retained at MONO Equipment

MONO Equipment is a business name of **AFE Group Ltd** Registered in England No. 3872673

VAT Registration No. 923428136

Registered office: Unit 35,
 Bryggen Road,
 North Lynn Industrial Estate,
 Kings Lynn Norfolk,
 PE30 2HZ

Mr Craig Petherbridge
 Quality & Compliance Manager

Mr Alex Davies
 Engineering Manager

QD 001

Dated 01/11/2022

Contents

	Thank you	i
	Safety Symbols.....	ii
	Electrical Safety Notice.....	iii
	Water Leak Safety Notice.....	iv
	General Notices	v
	Declaration of Conformity Certificate	vi
Chapter: 1	Introduction	
	1.1 The MONO Fan Assisted Deck Oven.....	1
Chapter: 2	Safety	
	2.1 General safety	3
	2.2 Oven safety.....	3
Chapter: 3	Installation	
	3.1 Safety messages	5
	3.2 Positioning the oven.....	5
	3.3 Electrical supply connections.....	6
	3.4 Water supply connections	7
Chapter: 4	Isolation	
	4.1 Isolating the oven from the electrical supply	9
Chapter: 5	Operation	
	5.1 Touchscreen operations	10
	5.2 Main Menu functions	11

5.3	Baking using the “Favourites” menu.....	12
5.4	Baking using the “Manual Bake” menu.....	16
5.5	Bake using the "Programmes" menu	20
5.6	Create a product bake program.....	23
5.7	Add a product bake program to "Favourites" menu	27
5.8	Setting the 7-day timer.....	28
5.9	Configurable oven settings (supervisor level)	29
5.10	Explanation of the general oven settings	31
5.11	Configurable oven settings (high level)	32
5.12	Explanation of the high-level oven settings.....	33
5.13	Sleep Mode function.....	34
5.14	Standby Mode and Auto Shutdown functions.....	35
5.15	Using the USB port	36
5.16	Diagnostics	39
Chapter: 6	Cleaning	
6.1	Safety messages	40
6.2	Daily cleaning.....	40
6.3	Daily cleaning tasks.....	40
Chapter: 7	Troubleshooting Bakes	
Chapter: 8	Service	
8.1	Contact information for customer services	42
8.2	Further information	42
8.3	Environmental disposal.....	42
Chapter: 9	Maintenance	
9.1	Safety messages	43
9.2	General maintenance	43
9.3	Preventative maintenance.....	43
Chapter: 10	Spares	

Appendix: A Passcodes

A.1 Default passcodes 50

Appendix: B Dimensional Drawings

B.1 Deck oven dimensions 52

Appendix: C Specifications

C.1 Electrical specifications 56
 C.2 Environmental specifications..... 56
 C.3 Mechanical specifications 57
 C.4 Functional specifications..... 58

Appendix: D Electrical Information

D.1 Electrical drawings and parts lists 59

1. Introduction

1.1. The MONO Fan Assisted Deck Oven

MONO's industry-leading fan-assisted, double-depth bakery deck oven is an easy-to-use, practical, and good-looking oven with an excellent heat recovery rate and an even bake across a wide range of bread and confectionery products.

- Good looking and totally reliable

Conceived with the no-nonsense requirements of both the independent and in-store baker in mind, and designed to visually please and give reliable service for many years, this deck oven will more than satisfy the most discerning customer

- Top quality specifications

The external and internal contact surfaces are stainless steel, so there's no fear of deterioration even after many years of hard use; plus, each deck is fitted with baking sheets manufactured from natural materials as a standard fitting.

The deck oven features an integral steaming system, resulting in a reduction in energy consumption and also a reduction in the overall size of the oven. The system produces natural steam, and because rapid recovery has been designed into the oven, you can use it repeatedly during a bake.

- No drainage is required

There are integral fans on each deck for time-saving convection baking. Reduced time in the oven means getting your product on to the shelves more quickly and selling.

Eco-touch ovens are supplied with touchscreen displays for user-friendly interactions. The colour display shows pictures of product types or program numbers set up via the USB port. When not being used, the screen can show your company logo. A voice prompt facility is also available for the basic instructions such as "Bake over".

Fitted with hinged easy-to-clean doors, individual top and bottom heat controls and seven-day bake timers for each deck, the oven gives the Master Baker a fast, even bake.

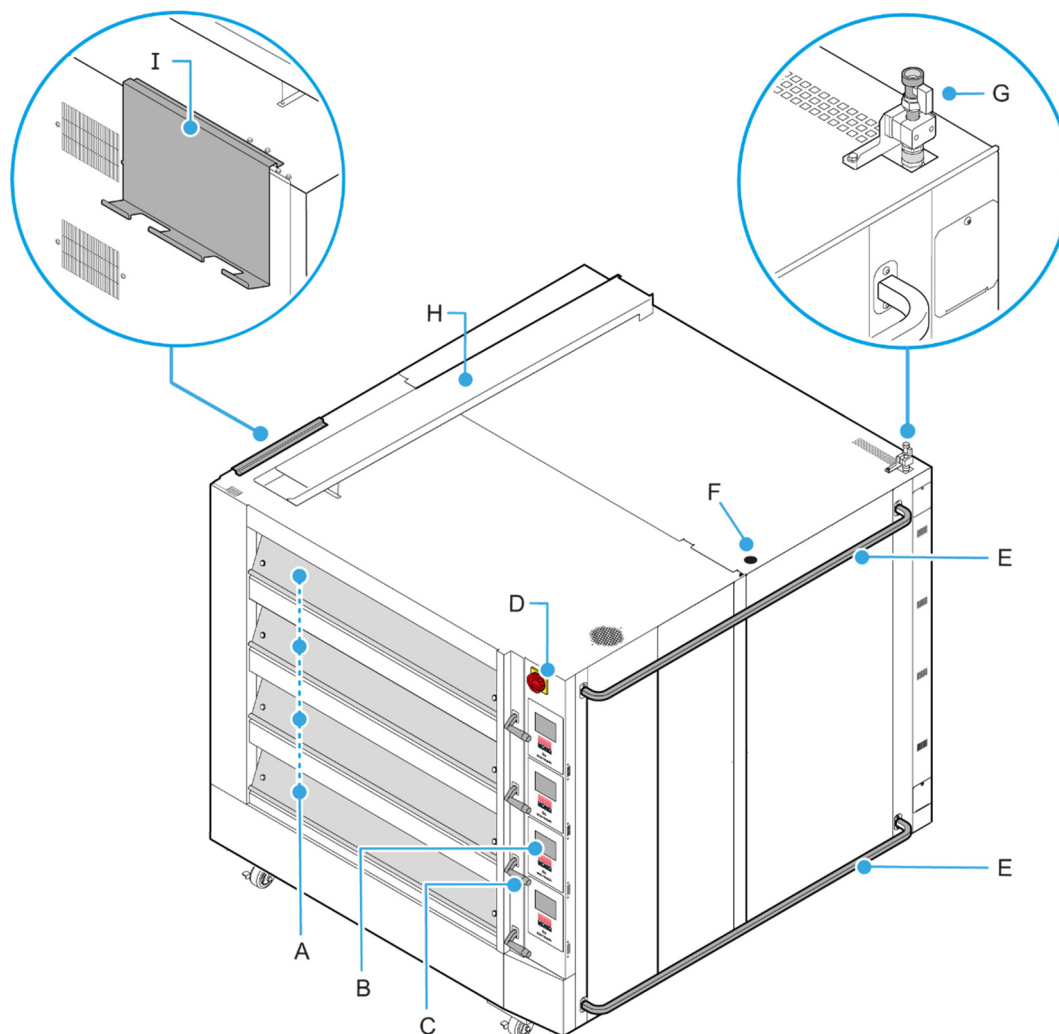
The electronic 'touch' controls on each deck are easy-to-use and designed for reliability and easy cleaning.

The flue system is integral to the unit and designed to reduce the build-up of combustible deposits in the flue.



NOTE

- Visit the [Fan Assisted Double Depth Deck Oven web page](#) for the latest information about the deck oven. Here you will also find PDF downloads of the latest product literature.

Figure 1.1: Deck oven features

-
- A. Four baking chambers
 - B. ECO-touch control and display panel
 - C. Door handle for opening and closing a baking chamber
 - D. Main isolator switch (normally in the ON position)
 - E. Steel bumpers
 - F. Power cable entry (M50 cable gland with lock nut supplied)
 - G. Single water inlet
 - H. Damper
 - I. Double-peel holder
-

2. Safety

2.1. General safety



CAUTION

■ Magnets information

- This fan-assisted deck oven carries a magnet behind each baking chamber door, which helps keep the deck oven's doors closed during the steaming process.
 - Magnetic fields in magnets, used in devices and machinery, can inhibit pulse generators for Implantable Cardioverter Defibrillators (ICDs) and pacemakers. Magnets can activate a switch prohibiting the ICD from delivering vital signals such as lifesaving shocks.
 - If you have an ICD or pacemaker, avoiding close or prolonged contact with magnets or their magnetic fields is advisable. Keep magnets at least six inches from where your device is implanted. **If you feel any interference in any way, immediately move away from the source.**
-

2.2. Oven safety

Only fully trained and authorised persons are permitted to do any work on the oven. Qualified electricians must carry out all electrical repairs and maintenance. Always disconnect or completely isolate the power supply before starting any maintenance or cleaning work on the oven.

A responsible Bakery Manager or Supervisor must carry out daily safety checks. Bakery staff must not, under any circumstances, remove covers or panels to access any internal parts of the oven.



DANGER

- Never use the USB port to power or recharge electronic devices e.g., mobile phones. Incorrect usage causes damage to the oven and could cause a fire.
-



WARNING

- Before using the oven:
 - Check that all covers, panels, and cabling are secure.
 - Visually examine the oven for obvious damage or signs of tampering.
 - If the oven is damaged, malfunctioning, or missing parts:
 - Stop using it. Do not attempt any repairs to the oven.
 - Contact MONO Equipment Limited for technical assistance.
 - Never operate the oven with any covers or panels removed.
 - All utility connections to the oven must comply with the statutory requirements of the country.
 - Ensure this user manual is read thoroughly before operating the oven. Operate and maintain the oven only as described in this user manual.
 - Never operate a steaming function with the oven door open.
-

**WARNING**

- Only fully trained and authorised persons are permitted to install the oven.
- There should always be a local disconnection switch for any person to isolate the electrical power in an emergency. The disconnection switch must be visible, labelled as an emergency shutdown device, and easily accessible.
- It is recommended that a qualified and competent electrician first tests the electrical outlet (power socket) for electrical safety. All electrical work must be in accordance with local and national regulations.
- Always check the electrical requirements on the machine's information plate before connecting the power for the first time. Contact MONO Equipment if the electrical information is not correct for your site.
- Always ensure your hands are dry before touching any electrical components, including cables, switches, and plugs.

**CAUTION**

- Be aware of hot surfaces:
 - Do not touch the oven door with bare skin.
 - Always use oven gloves when loading or unloading the oven.
 - Allow time for the oven to cool completely before cleaning it.
 - While baking (and for some time after use), touching the oven door or the surrounding panels is not advisable because of conducted heat.
- When removing products from the oven, ensure the following:
 - Tins are knocked out and stored directly onto a tin storage trolley or rack. Do not leave hot tins on the floor or tables.
 - Trays are put into a rack and then wheeled to a safe cooling area.
- Fully train operatives before they use the machine. Anyone undergoing training must be under direct supervision of someone experienced.
- Ensure there are no trip hazards around the oven, e.g. trailing cables.
- Check that the floor around the oven is not slippery, e.g. no liquid spills.
- Do not store items on top of or behind the oven.
- Never climb onto the roof of the oven.
- Only use the oven for baking bread, pastries, and cakes. Contact MONO Equipment Limited for other product-baking machines.
- No unauthorised modifications to the oven are permitted.

3. Installation

3.1. Safety messages



WARNING

- An electrical socket must be fitted with a 30mA-rated Type 'A' Residual Current Device (RCD) before installation and commissioning of the oven.
- Only fully trained and authorised persons are permitted to install the oven.
- There should always be a local disconnection switch for any person to isolate the electrical power in an emergency. The disconnection switch must be visible, labeled as an emergency shutdown device, and easily accessible.
- It is recommended that a qualified and competent electrician first tests the electrical outlet (power socket) for electrical safety. All electrical work must be in accordance with local and national regulations.
- Always check the electrical requirements on the machine's information plate before connecting the power for the first time. Contact MONO Equipment if the electrical information is not correct for your site.
- Always ensure your hands are dry before touching any electrical components, including cables, switches, and plugs.

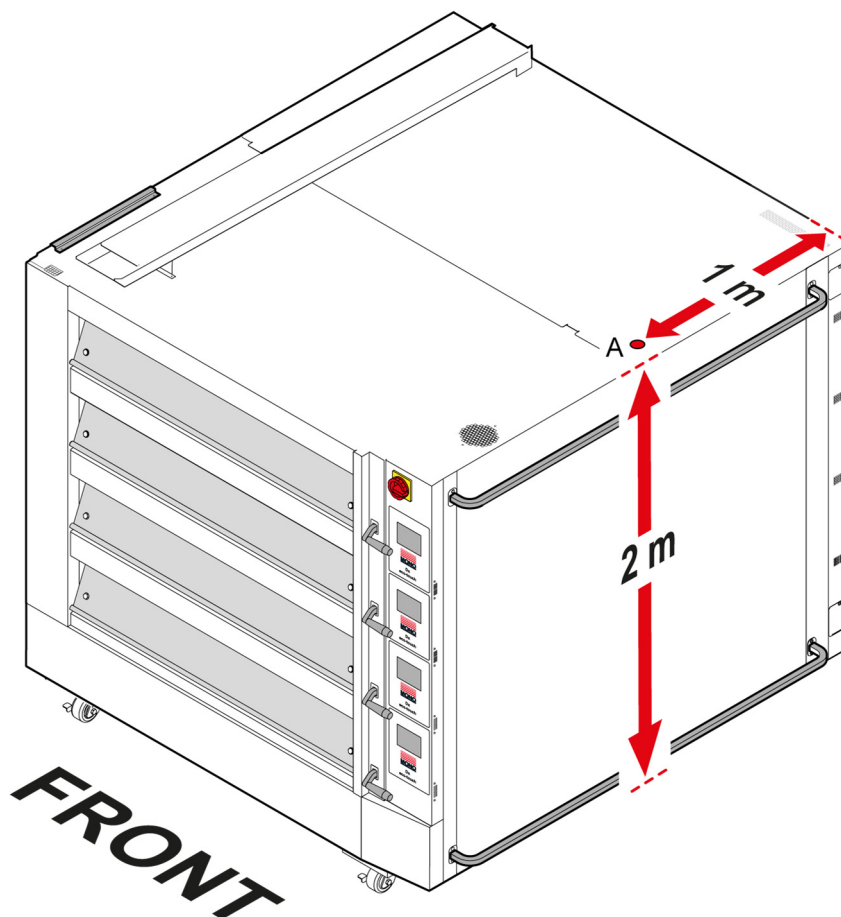
3.2. Positioning the oven

- A smooth and level concrete floor is a recommendation for positioning the deck oven,
- Access for maintenance of the oven should be considered.
 - The oven is a freestanding unit and must not be bolted down or fixed to the floor in any way.
 - Sufficient clearance must be left in front of the access panels (right-hand side) to allow for servicing.
 - Leave a clear space of 2 metres (6½ feet) in front of the oven for ease-of-operation and safety.
- Install a chain-based retainer (shorter than the power cable) to prevent cable strain when the deck oven is moved. Fix the retainer to the wall (or floor) and the base using a hole in the castor fixing corner plates.
- Leave a gap of at least 75 mm (3 inches) on the side of the oven that does not have bumpers. This space is to allow optimal cooling of the electrical chamber.
- If not selected when ordering the oven, an extraction hood should be placed above the oven to disperse excess steam and heat that could adversely affect the bakery ceiling and ambient temperature.

3.3. Electrical supply connections

- Read all the safety information before connecting the oven to the electrical supply.
 - See [Chapter 2](#) and [Section 3.1 on page 5](#) for safety information.
- MONO does not supply or fit a mains power cable for the deck oven. An M50 cable gland with a lock nut is provided loosely with the oven for an electrician to fit a customer-supplied power cable to the oven and connect it to the supply at the premises.
- The power cable entry hole for all deck supplies is on the oven's roof ([Figure 3.1 | A](#)). It is positioned on the right-hand side of the roof (when viewed from the front), approximately 1 metre from the back and 2 metres from the floor.
- See [Appendix C](#) for the electrical specifications.

Figure 3.1: Power cable entry on the oven's roof



A. Power cable entry

3.4. Water supply connections

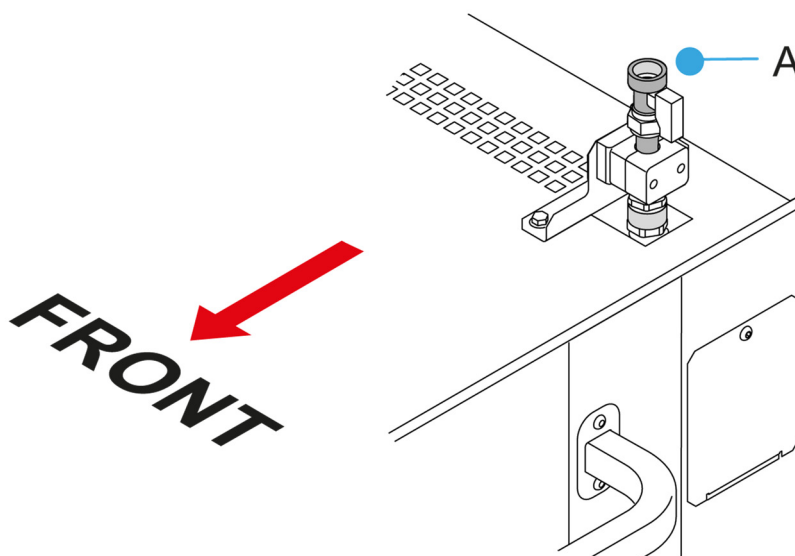
- All ovens with steam functionality require a 15 mm (½-inch) BSP plumbed cold water supply operating at a working pressure of 2 to 3 bar (29 to 44 psi). Standard domestic water supplies usually meet this specification.
- The water supply is recommended to conform to the following specifications:
 - Hardness of 2 to 4 grains per gallon.
 - PH range of 7 to 8.
 - Chloride concentration of 0 to 30 ppm.
- Only one water supply is required per oven stack. A manifold, fitted with a non-return check valve, supplies all decks from one connection point.
- The water inlet connection is on the oven's roof. It is positioned approximately 250 mm (9¾ inches) from the right corner and 100 mm (4 inches) from the top corner of the stand when facing the front of the oven ([Figure 3.2](#)).
- This oven does not require permanent drainage.
- Complete the [Water system setup procedure on page 8](#) for the steam function to operate correctly.



NOTE

- Customers are responsible for installing and maintaining an adequate water supply to the oven, which should comply with local water regulations (check with your local water authority).
- A water conditioning unit is advised for 'hard water' areas.

Figure 3.2: Water supply connection on the oven's roof



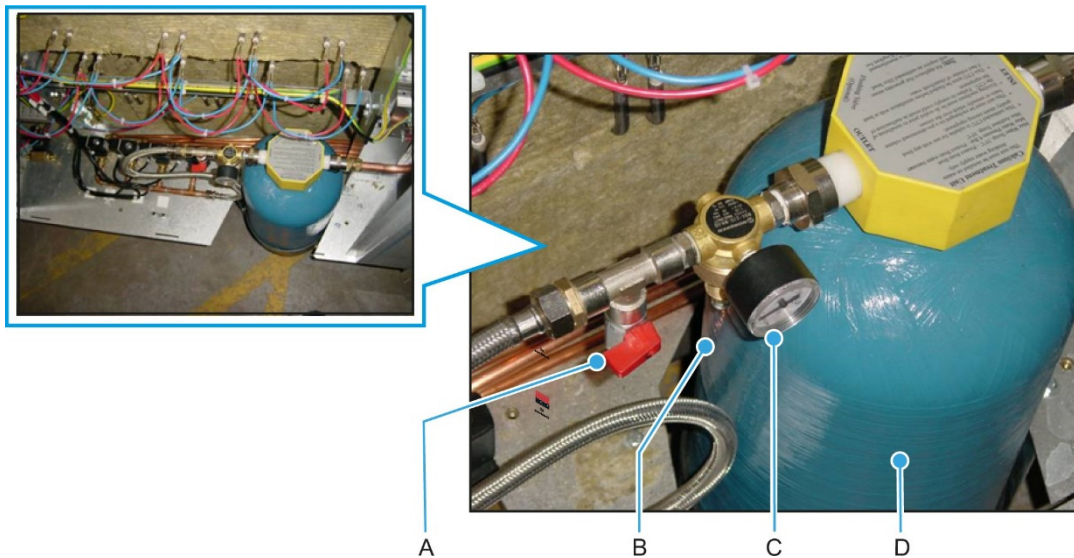
A. Water inlet valve (½-inch connection point) on the oven's roof

Water system setup procedure

1. Flush out the main feed pipe to be used until water runs clear and free from debris.
2. Connect the main feed to the water inlet valve on the oven.
3. Place a container under the drain valve.
4. Set-up the regulator.
 - a. Slowly open the drain valve.
 - b. With the water flowing, set the regulator to 3 bar (43.5 psi) using the screw underneath.
5. When the pressure has stabilised, shut the drain valve.
6. Repeat steps 3 to 5 at the end of the installation.

– **NOTE:** Never use the oven above this setting.

Figure 3.3: Water regulator set-up (located on rear of the oven)



A. Drain valve
B. Adjusting screw to set the regulator

C. Regulator
D. Water treatment filter



NOTE

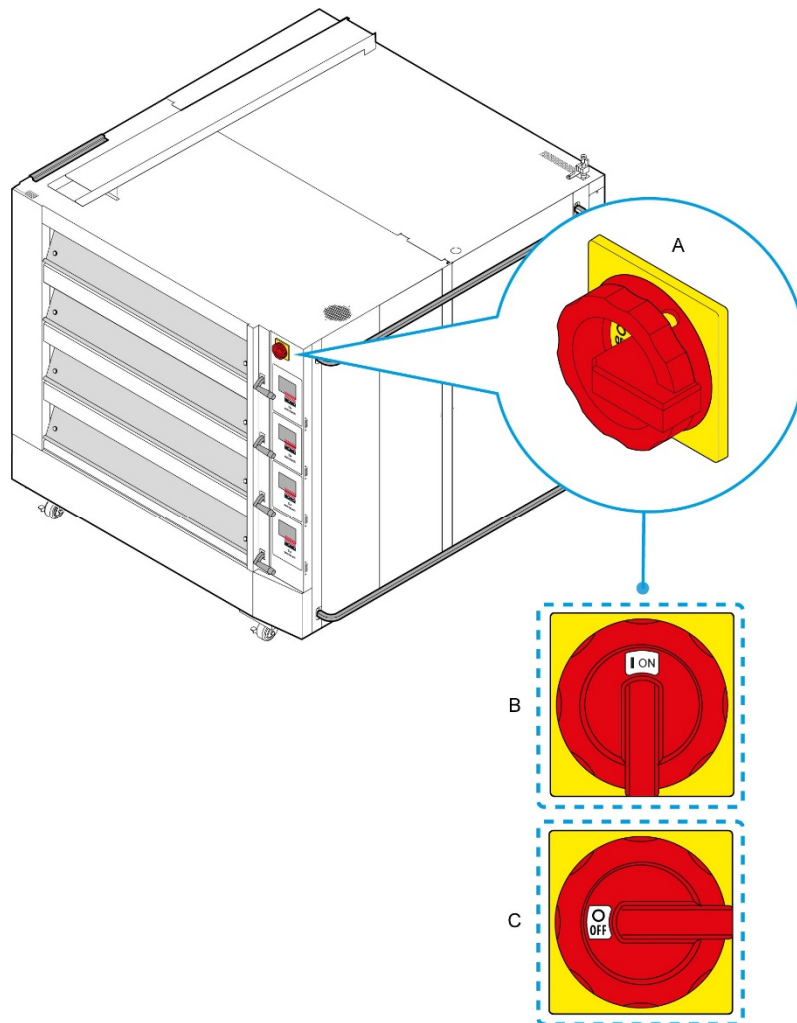
- Depending on the water supply area, the water treatment filter should be changed during yearly maintenance.

4. Isolation

4.1. Isolating the oven from the electrical supply

To stop the oven in an emergency, turn the main isolator switch to the 0 (OFF) position.

A wall-mounted isolator switch, rated for the specific model of oven installed, must also be available to isolate the oven completely in an emergency.



A. Main isolator switch

B. Switch position = **I (ON)**

C. Switch position = **O (OFF)**



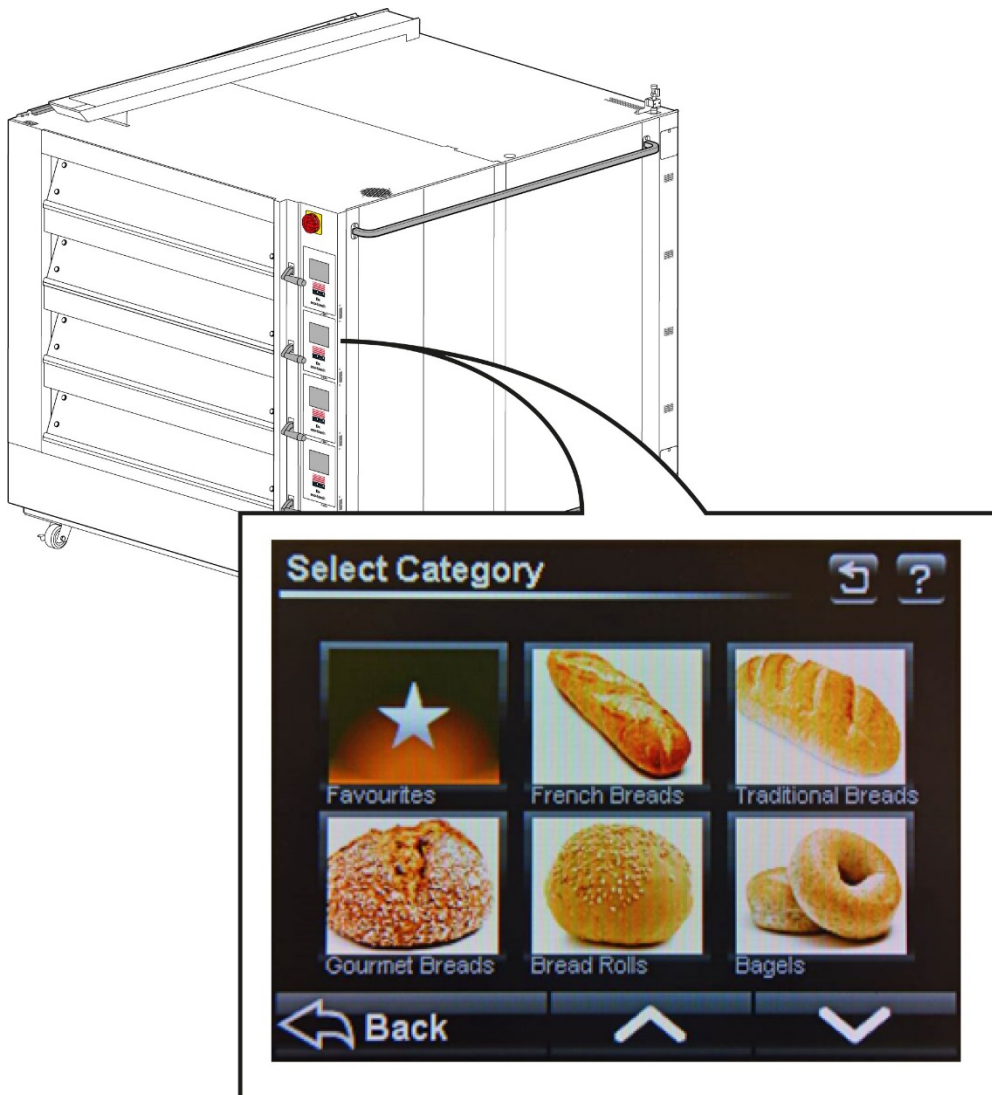
WARNING

- Always disconnect the oven from the consumer power supply if working on the electrical box and panel. Some components stay electrically energised even after the main isolator is in the 0 (OFF) position.

5. Operation

5.1. Touchscreen operations

Each deck has an independent colour touchscreen for operating the oven.



5.2. Main Menu functions

A main menu function is selected by touching a specific area on the display, which makes a new window appear or activates that function.



NOTICE

- Do not use excessive force.
- The pressure required to operate the touchscreen panel is adjustable in the **Settings** menu.

Figure 5.1: Main Menu of the ECO-touch Oven

Touch the screen in the ringed areas to choose an option.



- A. Favourites (see [Section 5.3](#))
- B. Manual bake (see [Section 5.4](#))
- C. Programmes (see [Section 5.5](#))
- D. 7-Day timer ([Section 5.8](#))
- E. Settings ([Section 5.9](#) and [Section 5.11](#))
- F. Standby mode ([Section 5.14](#))
- G. Sleep mode ([Section 5.13](#))

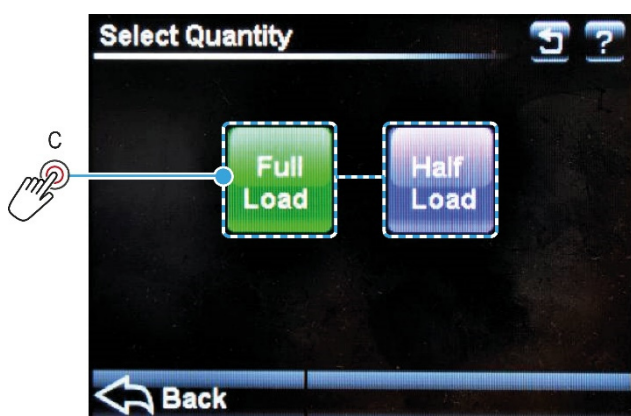
5.3. Baking using the “Favourites” menu

Procedure:

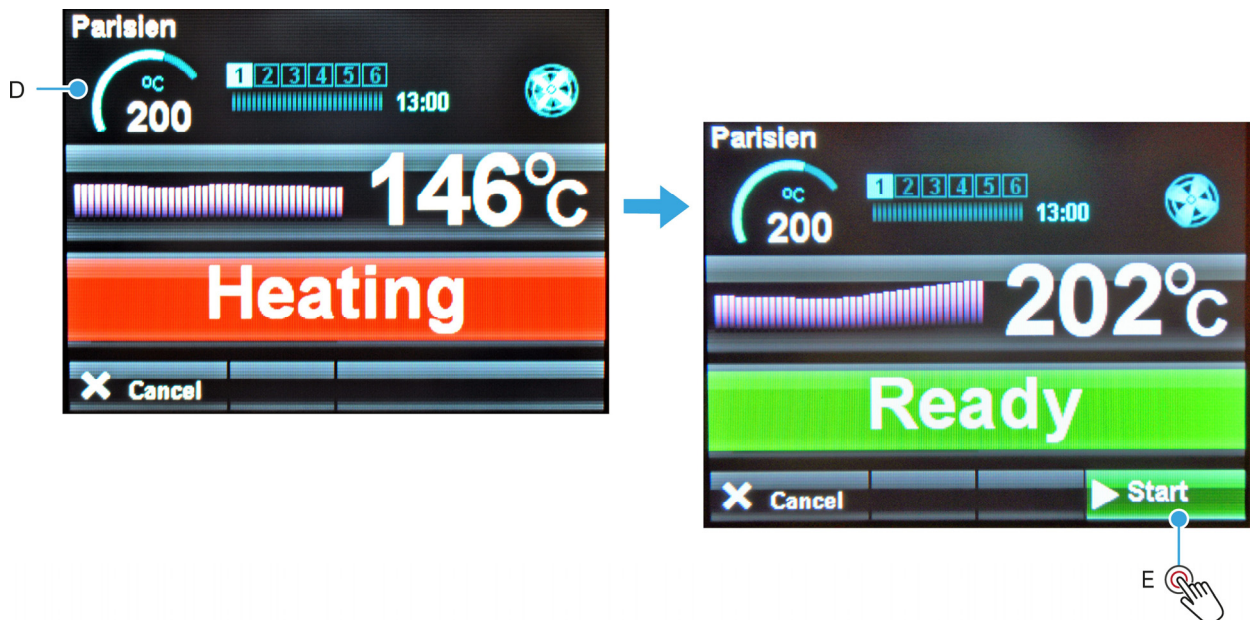
1. Touch the Favourites icon (A).
2. Touch the name of the product required, e.g. Parisien (B).
 - Up to five products are listed on a page.
 - Use the up-arrow and down-arrow buttons to see other product pages.



3. Touch the **Full Load** or **Half Load** icon (C).
 - This screen only appears if a half load is saved in the program.



4. Wait for the oven to reach the required temperature (D); 200 °C in this example.
 - If the oven is too hot for the temperature chosen, the screen tells you to open the door for cooling.
 - **Take care to avoid burns.** ⚠️
5. When the oven is at the correct temperature (Heating changes to Ready):
 - a. Open the oven door.
 - **Take care to avoid burns.** ⚠️
 - b. Carefully load the oven with the prepared trays of product.
 - c. Fully close the oven door.
 - d. Touch the Start button (E).

**NOTE**

- To minimise heat loss from the oven, do not leave the oven door open for longer than needed. The oven will automatically recover from the heat lost when the door is closed.

6. Monitor the bake in progress:
 - a. Observe the temperature profile bar and actual oven temperature (F).
 - The actual temperature shown rises above and falls below the required temperature (G) as the oven cools and reheats. This is not a fault with the oven.
 - b. Observe the baking progress bar and actual time remaining (G).



7. Touch the **View** button (H) during a bake to show the settings for that particular bake.
8. Touch the **Cancel** button (I) to go back to the previous screen. (It does not cancel the bake).



9. At the end of the bake time, a sounder will be heard and Bake Over will flash. To keep the oven baking for extra minutes, touch the **+ 2 mins** button (**J**).
10. When ready to stop the bake:
 - a. Touch the Stop button (**K**).
 - b. Open the door.
 - **Take care to avoid burns.** ⚠
 - c. Carefully remove the trays of product.



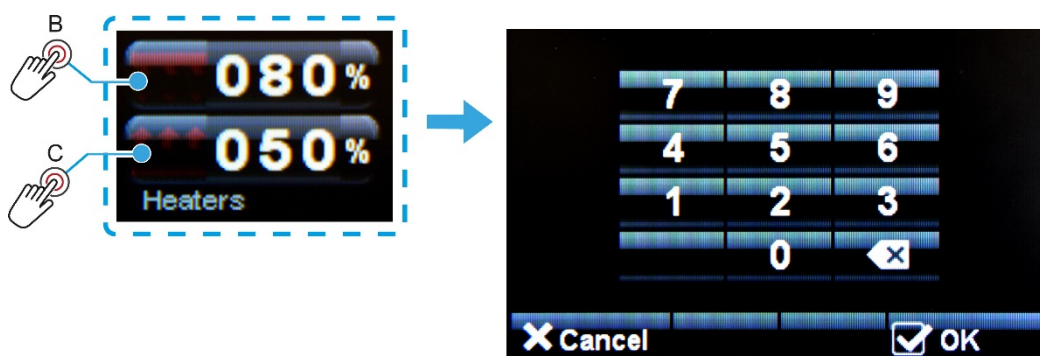
5.4. Baking using the “Manual Bake” menu

Procedure:

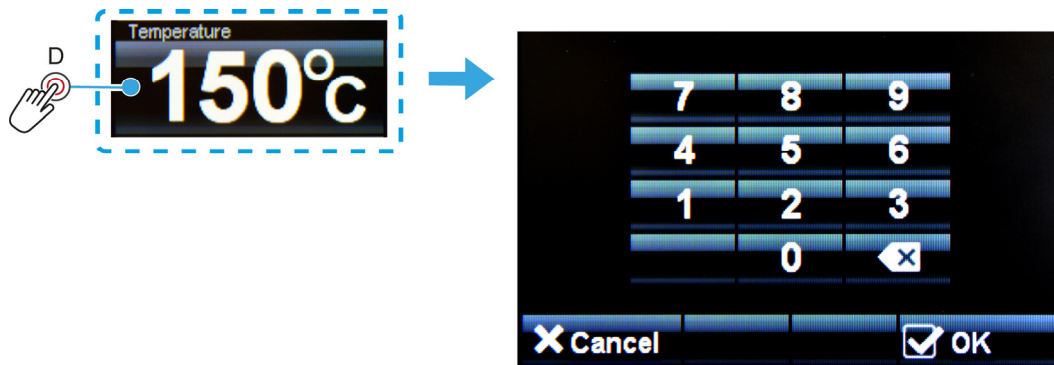
1. Touch the Manual Bake icon (A).



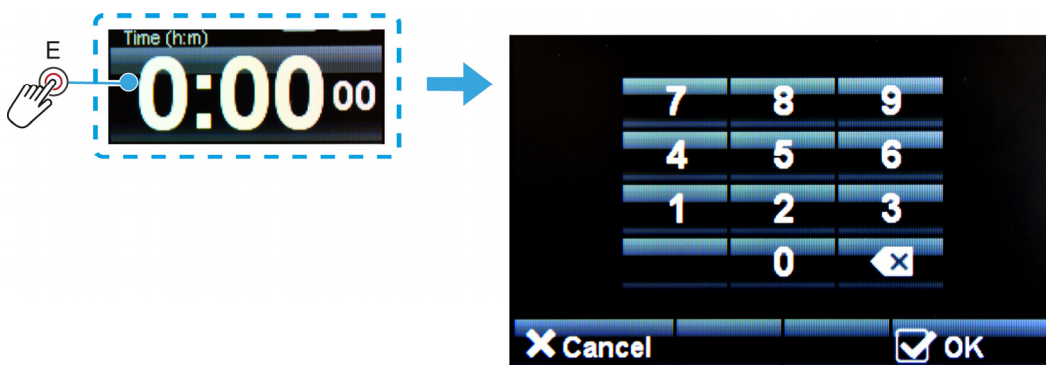
2. Set the top and bottom heat.
 - a. Touch a Heat % button (B or C) to activate the keyboard screen.
 - b. Use the keypad to input the required percentage of heat.
 - c. Touch OK.



3. Set the bake temperature.
 - a. Touch the temperature panel (D) to activate the keyboard screen.
 - b. Use the keypad to input the required temperature.
 - c. Touch **OK**.

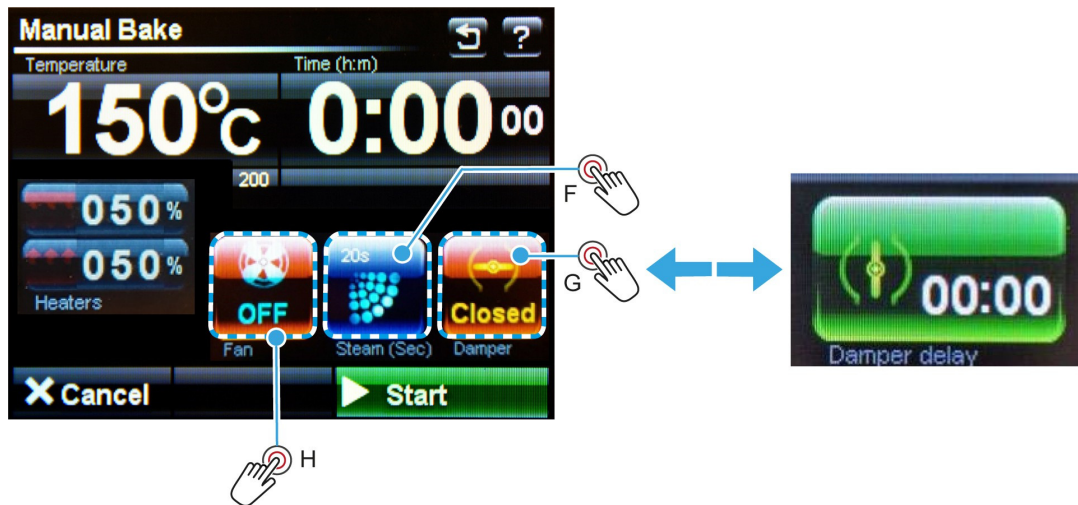


4. Set the bake time (optional).
 - The bake time does not have to be set in manual mode. When **Start** is touched, the timer increases instead of counting down. Touch **Stop** to finish the bake.
 - a. Touch the time panel ((E) to activate the keyboard screen.
 - b. Use the keypad to input the required time.
 - c. Touch **OK**.



5. Steam function: Touch and hold the Steam icon (F) for the time required.
 - The steam function can be used before or during a bake.
6. Manual damper function:
 - a. Touch the Damper icon (G) to open the damper.
 - The icon changes colour to green.
 - b. Touch the Damper icon again to close the damper.
 - The icon changes colour to red.

7. Fan function: Touch the Fan icon (H) and setup the fans to be used during the bake.



8. When the oven is at the correct temperature:
- Open the door.
 - **Take care to avoid burns.** ⚠️
 - Carefully load the oven with the prepared trays of product.
 - Close the door.
9. Touch **Start** to begin the bake.



10. Touch **Stop** when the end-of-bake buzzer sounds or the required baking time has elapsed.

11. Save the program (optional).



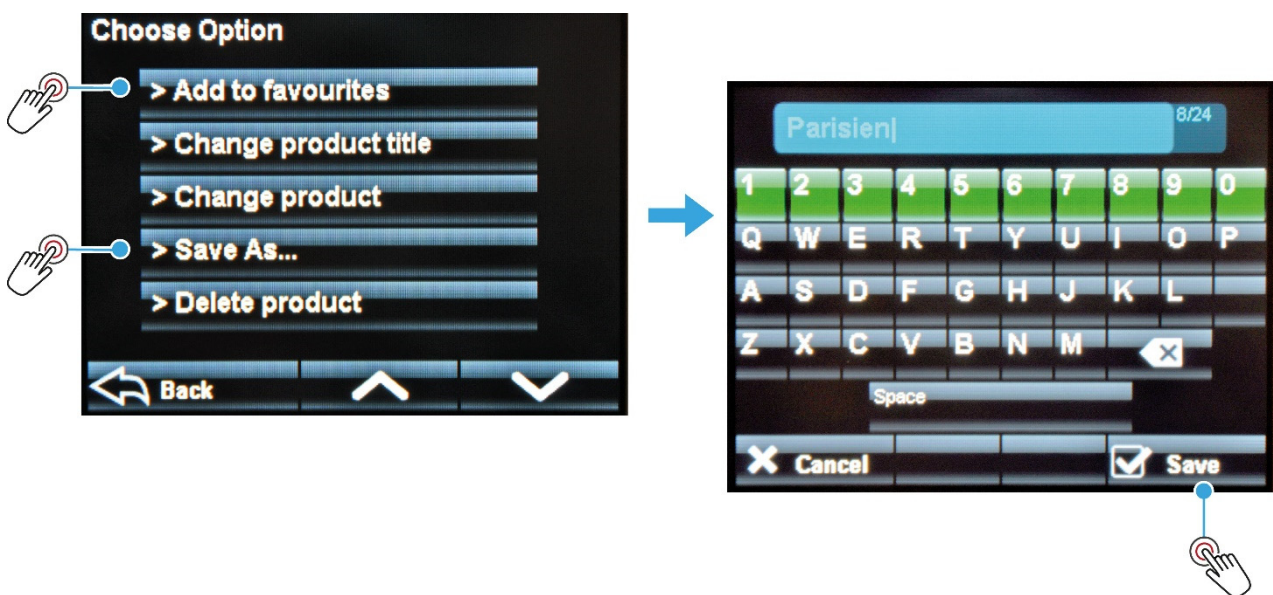
NOTICE

- The **Save** button appears if no time was entered at the start of the bake.
- In Manual Bake mode, only one operation of the steam or damper is saved in the program.

- a. Touch **Save** on the Manual Bake screen.



- b. Touch **Add To Favourites** or **Save As...** on the Choose Option screen.
- c. Use the keyboard to type the program name.
- d. Touch **Save** on the keyboard screen.



5.5. Bake using the "Programmes" menu

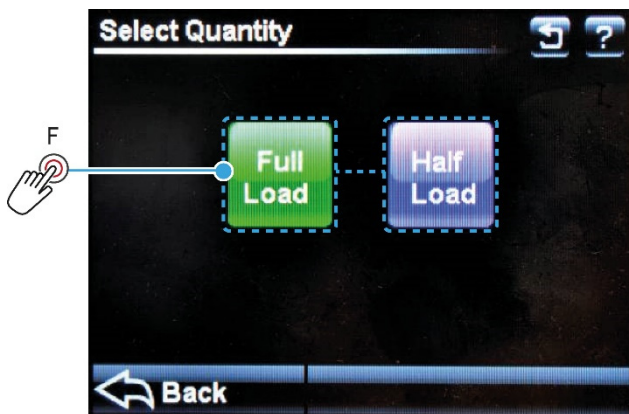
This procedure is for two versions of the firmware. The oven can be set-up to show **pictorial choices** of product categories or **numerical choices** that show ranges of programme numbers.

1. Touch the Programmes icon (A).
2. Touch a category (B) or programme number range (C), as appropriate for your set-up.

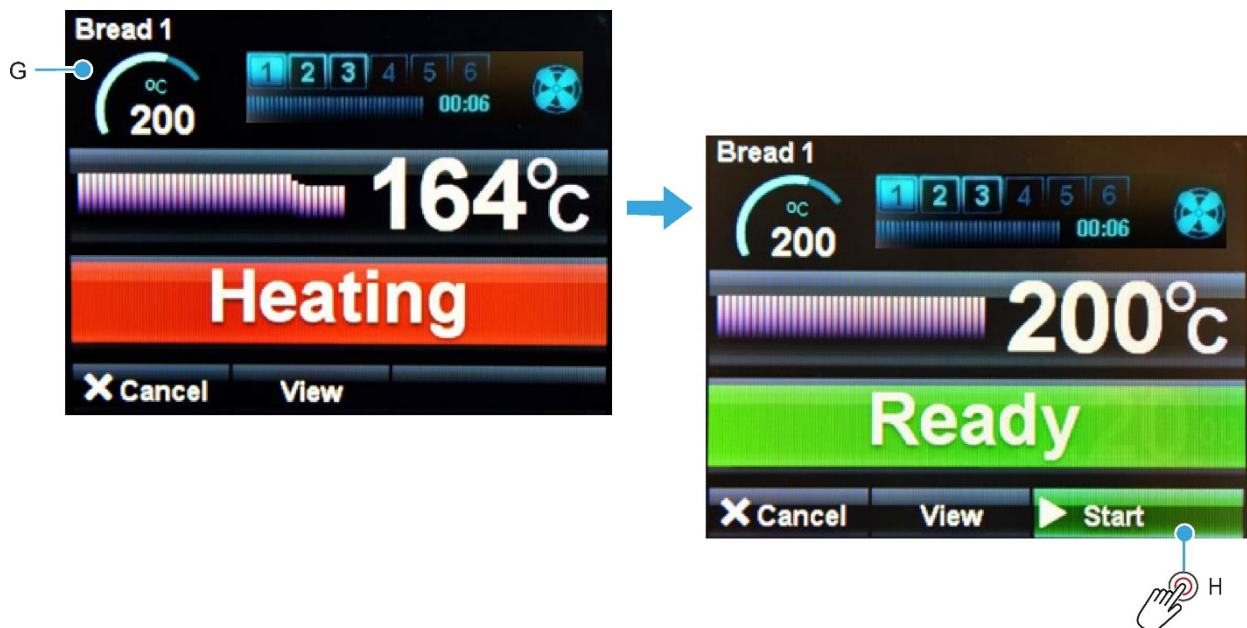


3. Touch the name (D) or number (E) of the required product.

4. Touch the **Full Load** or **Half Load** icon (F).
 - This screen only appears if a half load is saved in the program.

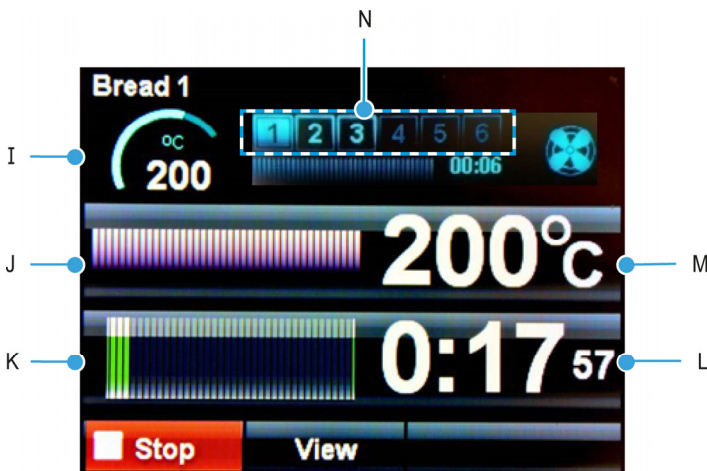


5. Wait for the oven to reach the required temperature (G); 200 °C in this example.
 - If the oven is too hot for the temperature chosen, the screen tells you to open the door for cooling.
 - **Take care to avoid burns.** ⚠
6. When the oven is at the correct temperature (Heating changes to Ready):
 - a. Open the door.
 - **Take care to avoid burns.** ⚠
 - b. Carefully load the oven with the prepared trays of product.
 - c. Close the door.
 - d. Touch the **Start** button (H).

**NOTE**

- To minimise heat loss from the oven, do not leave the oven door open for longer than needed. The oven will automatically recover from the heat lost when the door is closed.

7. After starting the bake, the screen changes to show the baking time.



- | | | |
|------------------------|----------------------------|---------------------------|
| I. Set temperature | J. Temperature profile bar | K. Bake time progress bar |
| L. Bake time remaining | M. Actual temperature | N. Bake phase (when used) |

8. Touch the **View** button to show a screen with settings for the bake in progress.
- The **Cancel** button returns the display to the previous screen.
9. When the bake is finished, a sounder is heard and **Bake Over** flashes on the screen.
- Touch the **Stop** button (O) and remove the product from the oven, or
 - Touch the **+ MIN** button (P) for additional bake minutes (adjustable in the Settings menu).



NOTE

- The actual oven temperature fluctuates. It may briefly drop below, or rise above, the required temperature by a few degrees during baking. This is normal and not a malfunction of the oven.
- To minimise heat loss from the oven, do not leave the oven door open for longer than needed. The oven will automatically recover from the heat lost when the door is closed.

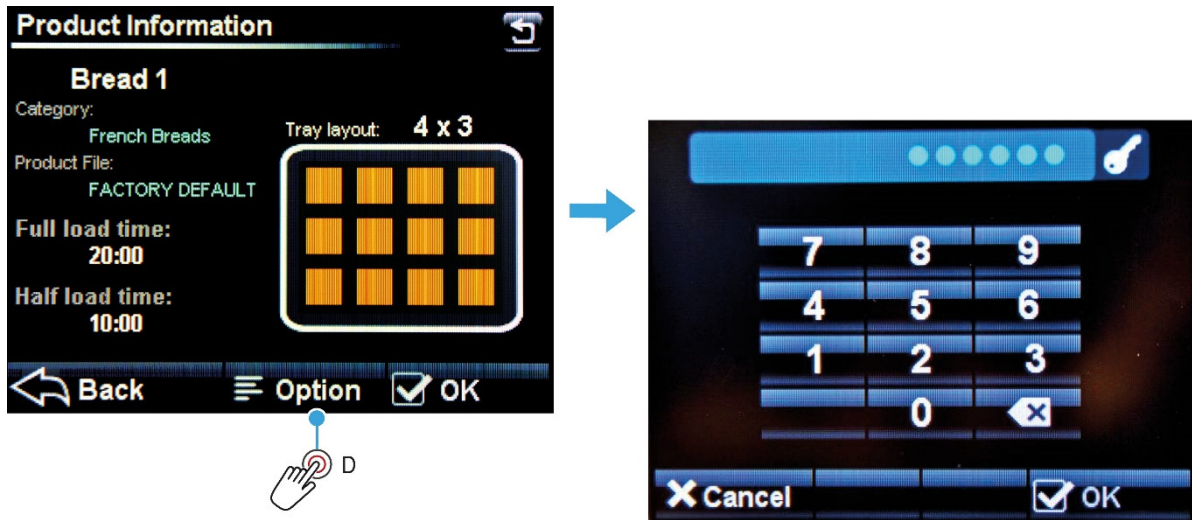
5.6. Create a product bake program

1. Touch the **Programmes** icon (A).
2. Touch a category (B) or programme number range (C), as appropriate for your set-up.



3. Touch the down arrow ∇ until the first blank program space is seen.
4. Touch the **i** button next to the blank program space.

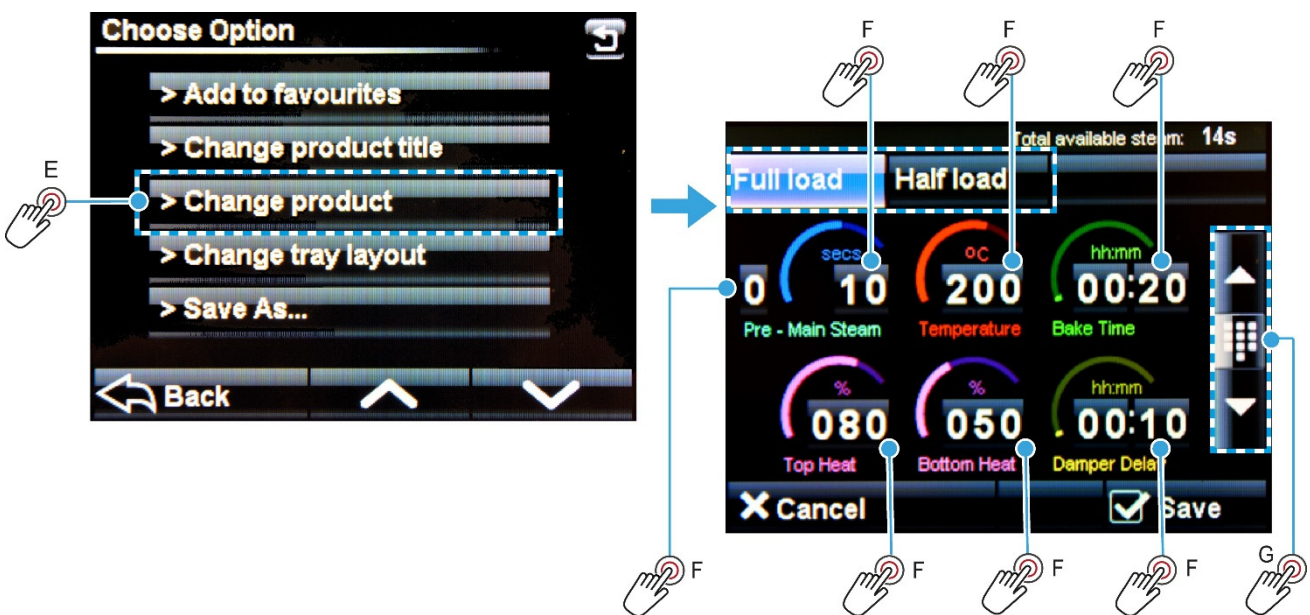
5. Touch the **Option** button (D) on the Product Information screen.
6. Enter the **Supervisor** passcode and then touch **OK**.



NOTE

- Default passcodes for the various access levels are in [Appendix A](#). However, for security reasons, the passcodes section may have been removed.

7. Configure the product bake settings.
 - a. Touch the **Change Product** button (E).
 - b. Touch **Full Load** to switch to the **Half Load** settings (if required).

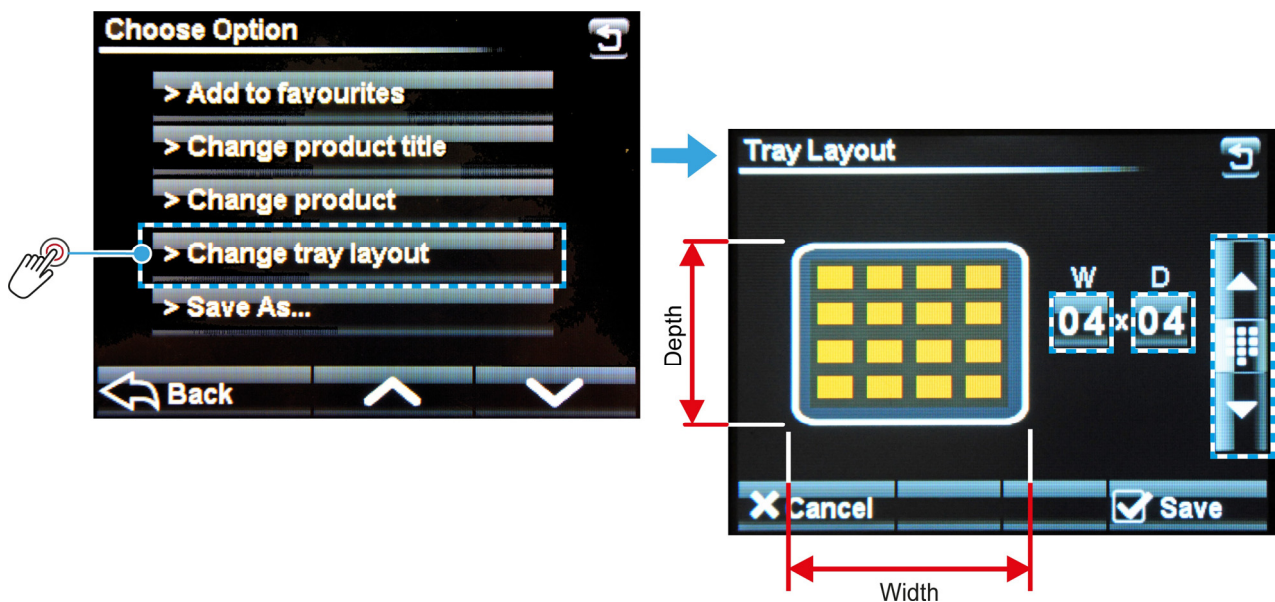


- c. Touch a **Bake Phase Number** button to switch to another baking phase (if required).
- d. Touch each editable item (**F**).
- e. Use the arrow buttons or keypad (**G**) to change the values.
- f. Touch **Save** when satisfied with the settings of each load-type and baking phase.

**NOTE**

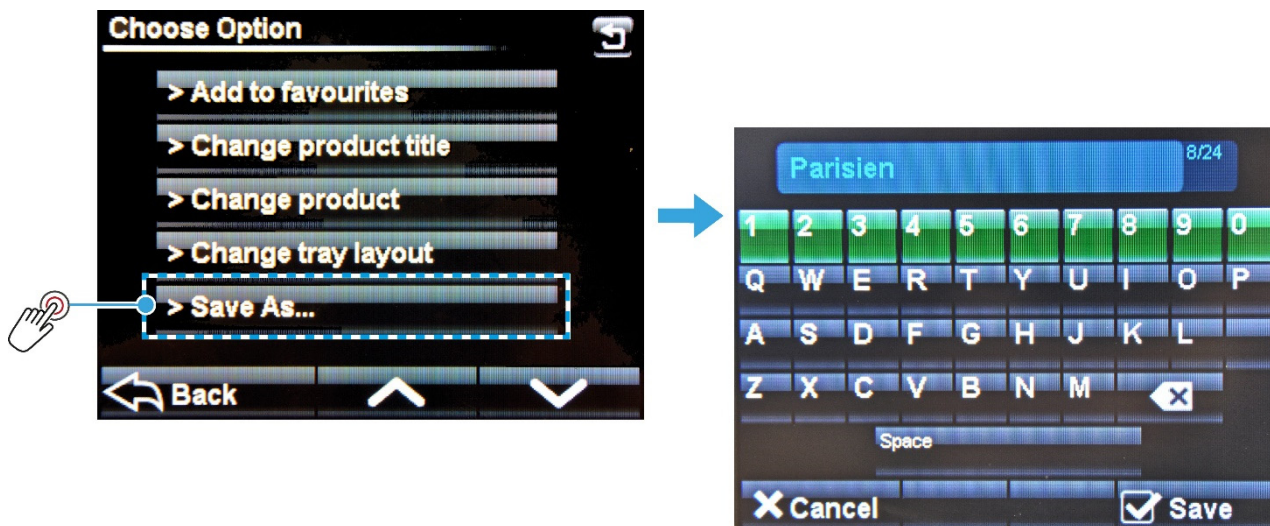
- Pressing **Half Load** switches back to the **Full Load** settings.

8. Configure the tray layout.
 - a. Touch the **Change Tray Layout** button.



- b. Touch the **W** (Width) value.
- c. Use the arrow buttons or keypad to change the number of products across the tray.
- d. Touch the **D** (Depth) value.
- e. Use the arrow buttons or keypad to change the number of products down the tray.
- f. Touch **Save** to confirm the tray layout.

9. Save the program for future use.
 - a. Touch the **Save As...** button.
 - b. Type in a name for the new program.
 - c. Touch **Save** to save the new program.



5.7. Add a product bake program to "Favourites" menu

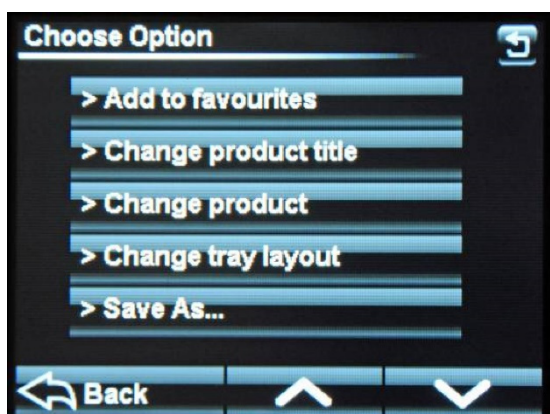
1. On the **Select Category** screen, touch a product type.



2. On the **Select Product** screen, touch the **i** (information) button next to the product you want as a favourite.



3. On the **Choose Option** screen, touch **Add to favourites**.



4. The product bake program now appears on the favourites list. See [Baking using the "Favourites" menu on page 12](#) for instructions to select this favourite.

5.8. Setting the 7-day timer

When the oven is in standby mode, it can heat up at preset times each day as required. Up to four on/off times can be set for each day of the week.

1. Touch the **7-Day Timer** button (A).
2. Touch a day (B) when the oven is to heat up.
3. Set the on time (C).
 - a. Touch the **Hour** setting.
 - b. Set the hour using the arrow keys or keypad.
 - c. Touch the **Minute** setting.
 - d. Set the minutes using the arrow keys or keypad.
4. Set the off time (D) using the same method.
5. Touch **Save** to immediately activate the timer.

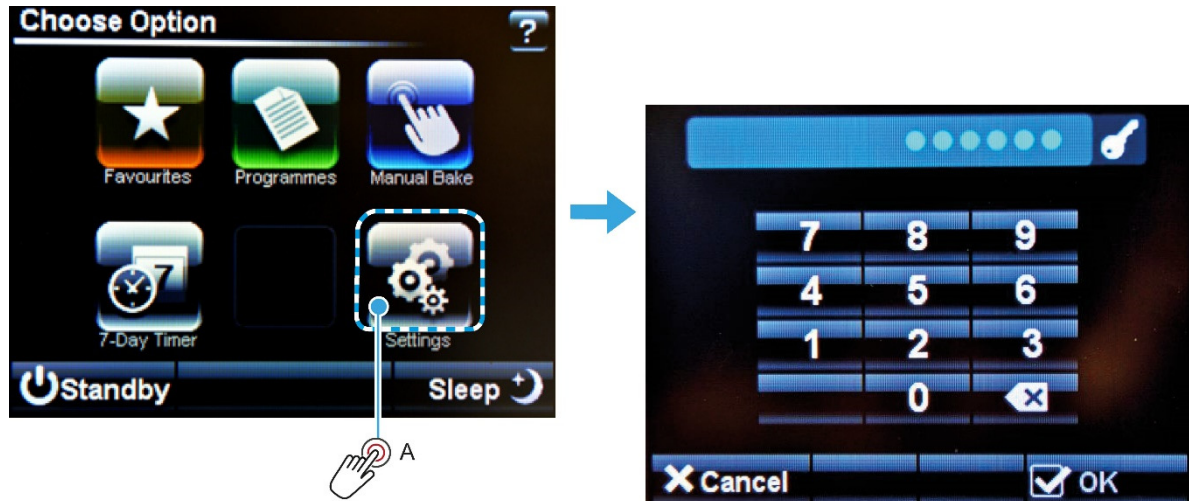


NOTE

- The settings can be cleared for a selected day by touching **Clear**.

5.9. Configurable oven settings (supervisor level)

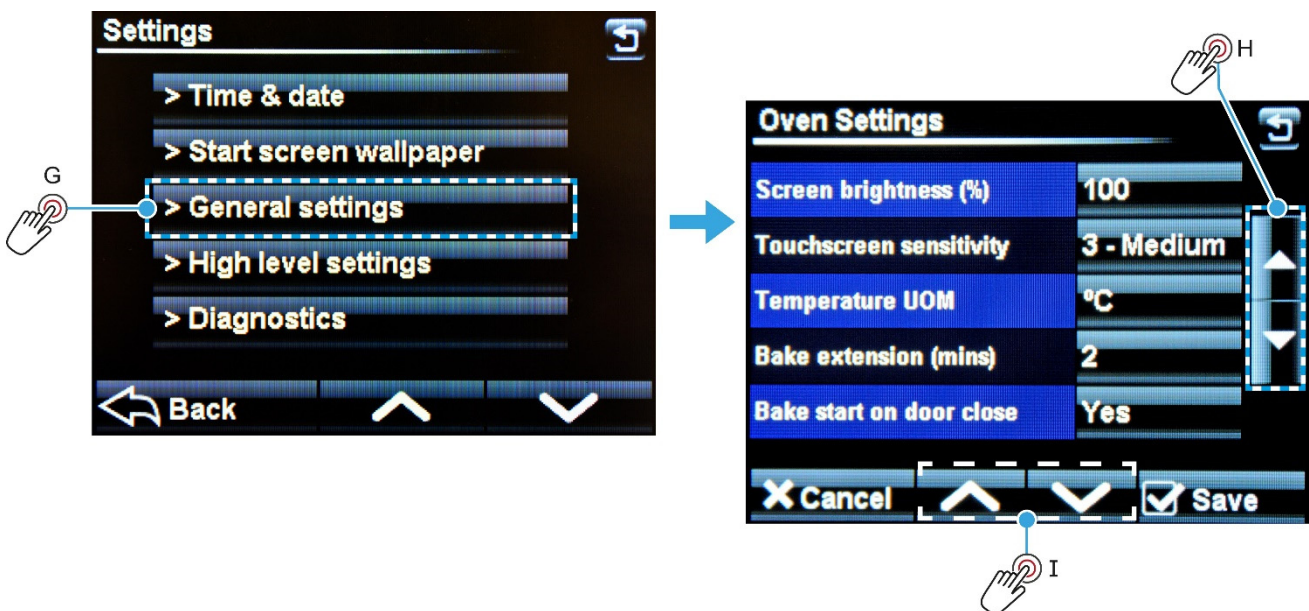
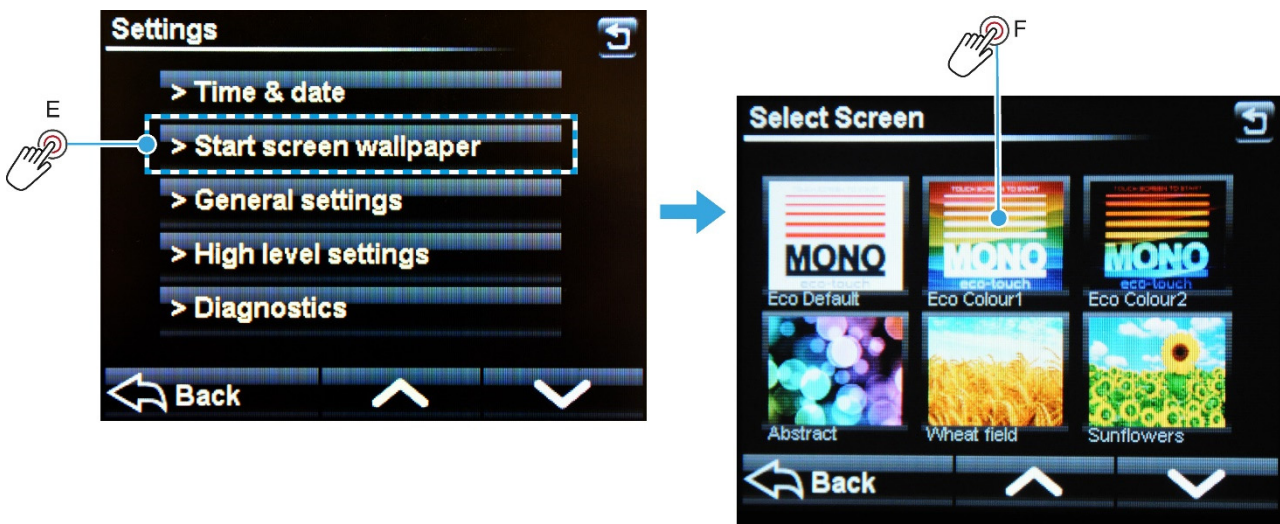
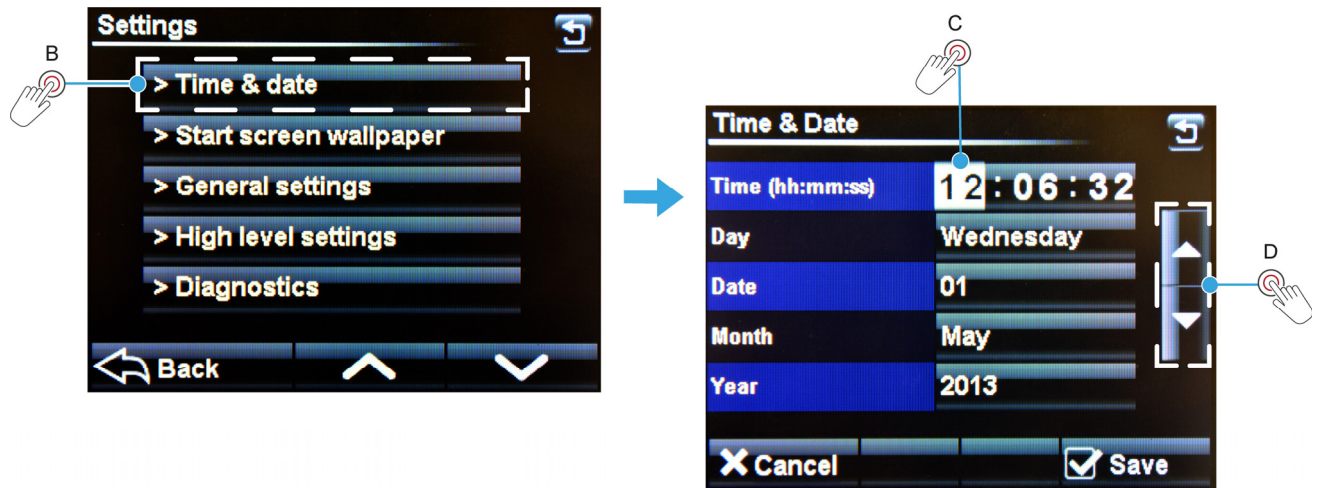
1. Touch the Settings button (A).
2. Enter the **Supervisor** passcode, and then touch the **OK** button.



NOTE

- Default passcodes for the various access levels are in [Appendix A](#). However, for security reasons, the passcodes section may have been removed.

3. Change the time and date (if required).
 - a. Touch Time & Date (B).
 - b. Touch the item that needs changing (C):
 - Time, Day, Date, Month or Year.
 - c. Use the up and down arrows (D) to change the setting.
 - d. Touch **Save** to confirm the new settings.
4. Change the start screen wallpaper (if required).
 - a. Touch **Start Screen Wallpaper** (E)
 - b. Select the wallpaper (F) and touch **Back** to confirm.
5. Change the general oven settings (if required).
 - a. Touch the **General Settings** (G)
 - b. Use the page-down and page-up arrows (H) to move through all the oven settings.
 - c. Touch an oven setting.
 - d. Adjust the oven setting value using the increase or decrease arrows (I).



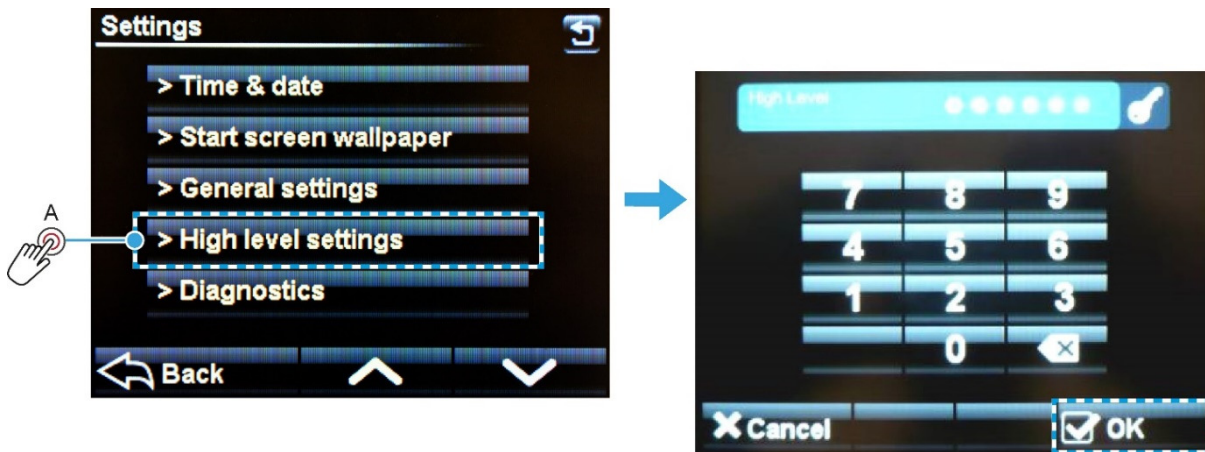
5.10. Explanation of the general oven settings

Table 5.1: General oven settings

Oven setting	Explanation of the setting	Default
Screen brightness	Adjusts the brightness level of the viewing screen. Settings are 5 to 100 .	100
Touchscreen sensitivity	Adjusts the pressure required to operate the touch screen. There are 5 levels of sensitivity.	3 - Medium
Temperature unit of measure	Centigrade (Celsius) or Fahrenheit. Settings are °C and °F .	°C
Bake extension (minutes)	Adjusts the extra time at the end of a bake for each “extra time” button touch. Settings are 0 to 10 minutes.	2
Reselect product after bake	Resumes with the same product program without having to reselect it. Settings are Yes or No .	Yes
Sleep mode delay	The oven goes into sleep mode after the set minutes, providing it is up to temperature and has been through at least one bake cycle. Settings range from 0 up to 60 minutes.	0
8 hour countdown timer	After 8 hours, the oven gives a warning and then turns itself off. Touch any button for an extra hour, if required. Settings are On and Off .	Off
7-day Smart timer	On = 7-day timer function controls the oven start-time. Off = Start-time is dependent on the oven temperature.	Off
Pump time (sec)	Increase pipe pressure for a set time before steaming. Settings are 0.0/3.0 .	0.5
Chart interval (sec)	Time interval in seconds for the bars that show on the heat and bake-time progress charts.	5
Sounder select	Set as External or Internal sounder.	External
Sounder tone	Select a tone - Voice , Tone , or Off .	Tone
Sounder volume	Adjust to suit the volume required for the on-board sounder. Settings are 0 to 15 .	8
Shortcut buttons 1 fn to 5 fn	It gives a choice of what buttons are active and in which order they appear on the options screen. Settings are: * Fav (Favourites) * Progs (Programs) * Manual (Manual bake) * Multi (Multi-bake) * 7-Day (7-day timer) * [Blank] (not used) (Settings at 6 fn cannot be changed).	1 fn = Fav 2 fn = Progs 3 fn = Manual 4 fn = 7-Day 5 fn = [Blank]
Door open alarm	Turns the alarm on or off for when the door is opened during a bake program. Settings are On and Off .	On

5.11. Configurable oven settings (high level)

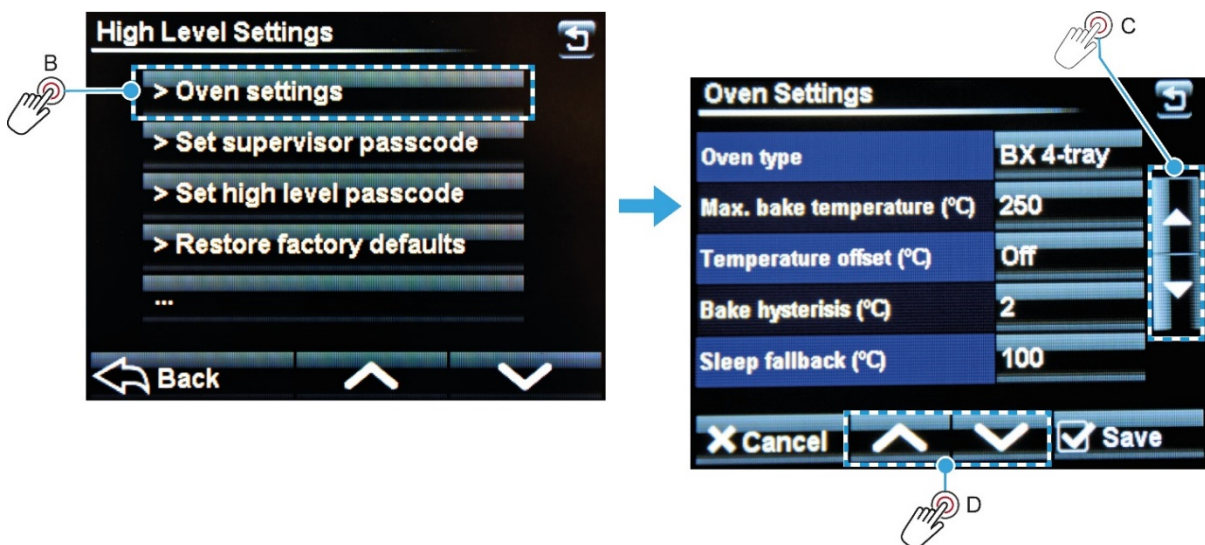
1. Touch the **High level settings** button (A).
2. Enter the **High-level settings** passcode, and then touch the **OK** button.



NOTE

- Default passcodes for the various access levels are in [Appendix A](#). However, for security reasons, the passcodes section may have been removed.

3. Change the general oven settings (if required).
 - a. Touch the **Oven settings** button (B).
 - b. Use the page-down and page-up arrows (C) to move through all the oven settings.
 - c. Adjust the oven setting value using the increase or decrease arrows (D).



NOTE

- Use the **Set Supervisor Passcode** or **Set High Level Passcode** buttons if wanting to change the passcodes. The **Restore Factory Defaults** button restores all screens (except passcodes) to the original default settings.

5.12. Explanation of the high-level oven settings

Table 5.2: High-level oven settings

Oven setting	Explanation of the setting	Default
Oven type	Select the oven version that the screen is installed on.	DX
Maximum bake temperature (°C)	Settable maximum limit up to 300 °C .	250
Temperature offset (°C)	Use an offset to adjust the displayed actual temperature in the oven.	Off
Bake hysteresis (°C)	Sets the baking temperature to cycle around (above and below) a set point. Settings range from 1 to 20 .	2
Sleep fallback (°C)	Set the temperature required to be maintained by the oven whilst in sleep mode. Settings are 100 to 200 °C	100
Sleep hysteresis (°C)	Keeps the "sleep mode" temperature to cycle around (above and below) a set point. Settings range from 1 to 20.	2
Ready accept high (°C)	The highest temperature for the oven to display "Ready".	15
Ready accept low (°C)	The lowest temperature for the oven to display "Ready".	-10
Steam type	Settings are Plate or Spray - keep this set to Plate for the deck oven.	Plate
Top gain (°C)	Set how the temperature increases for the top heating elements.	50
Bottom gain (°C)	Set how the temperature increases for the bottom heating elements.	50
Mono constant	Factory set. Do not change the value unless instructed to do so.	(Factory)
Steam trough temp.	Not applicable to this oven.	
Steam hysteresis	Not applicable to this oven.	
Steam trough accept	Not applicable to this oven.	
Light output soft start	Set a delay of up to 60 seconds before restarting the fan after steaming.	0
Heater control	Always fixed to the Contactor setting for this oven. The Solid State option is not used at present.	Contactor
I/P diagnostic	Displays the inputs and outputs at the top of the screen to aid fault-finding.	Off

5.13. Sleep Mode function

If enabled in the oven settings menu, the **Sleep Mode** button instructs the oven to revert to a defined, pre-set temperature after a period in an idle state.

The 'Sleep' state reduces energy consumption by reverting the oven to the optimum core temperature between bakes, usually around 50 °C lower than the baking temperature.

This process enables the oven to return to full baking heat as quickly as possible, preventing the oven from standing idle and consuming the power required for baking temperatures.

Figure 5.2: Putting the oven into Sleep mode



Figure 5.3: Exiting Sleep mode



5.14. Standby Mode and Auto Shutdown functions

The **Standby Mode** button turns the oven off until the screen is touched again.

An alternative to the **Standby Mode** is the **Auto Shutdown** function, which prevents the oven from using costly energy when left on for long periods or overnight by mistake.

The **Auto Shutdown** facility is activated by enabling the 8-hour countdown timer in the **General Settings** menu.

When the oven is next switched on, an 8-hour countdown timer is started. If there has been no activity during the 8 hours and the oven is not in a bake cycle, the oven is turned off. Touch the screen to turn the oven on.

Figure 5.4: Putting the oven into Standby mode



Figure 5.5: Exiting Standby mode



5.15. Using the USB port

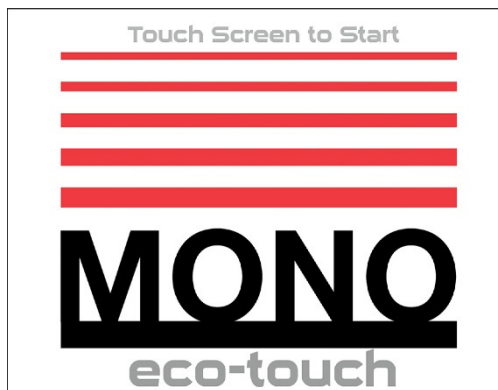
Prerequisite: See [Notes on using USB sticks on page 38](#).



DANGER

- Never use the USB port to power or recharge electronic devices e.g., mobile phones. Incorrect usage causes damage to the oven and could cause a fire.

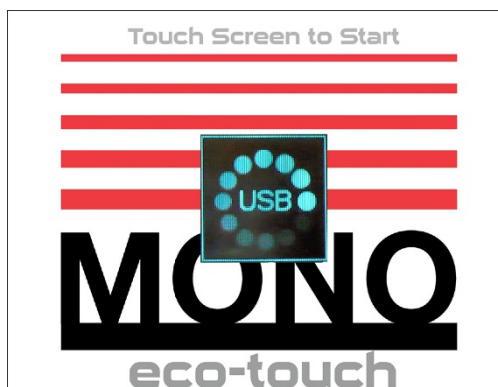
1. Ensure the start screen is showing.



2. Insert the USB memory stick (pen drive) into the socket on the oven panel.
 - A rubber plug may have to be removed from the socket first.
 - The USB memory stick only fits in one way. Do not force it into the socket.



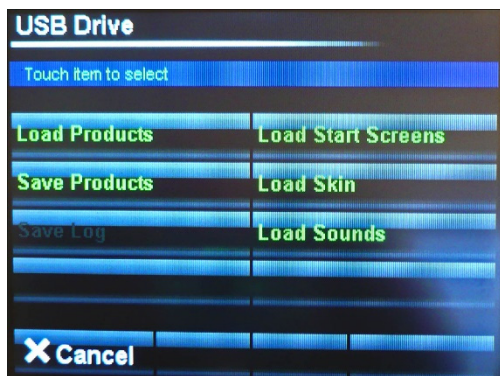
3. Wait for the USB symbol to finish moving.



4. If old firmware is found, the firmware version screen will appear.



- a. Touch **OK** to update firmware.
 - b. Wait until the eco-touch controller has restarted after the update is complete.
 - c. Remove the USB stick or touch **Cancel** to choose other items to update or change.
5. Choose the action you would like to do (e.g. **Load Products**).



6. Select the file required (e.g. **MALEVOX**).



7. Remove the USB stick when confirmation of "file loaded OK" is seen.

Notes on using USB sticks

For a USB stick (pen drive) to function correctly on a Mono oven with a port, it must have the following folder structure as a root folder.

Mono	(Create 5 sub-folders within the Mono folder
	Firmware
	Products
	Skins
	Sounds
	Startup

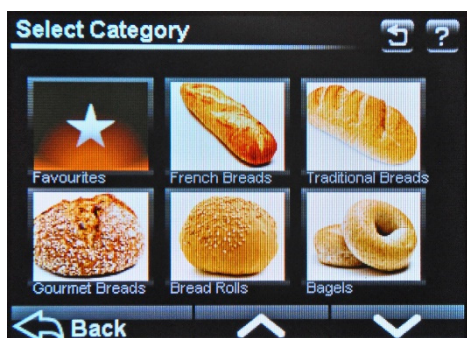
The oven automatically finds the Mono folder after plugging the USB stick into the port. Use any USB stick (as it does not need to be blank), but the Mono folder must be in the root.

Place your recipe and product files in the “Products” sub-folder. The most used sub-folders are Product Files, Skins, and Startup Screens.

Skins

These files control the way the screen looks in different modes.

- **Pictorial** type skins are for when the screen displays categories using pictures.



- **Numerical** type skins are for when the screen displays categories using numbers.



Products (program files)

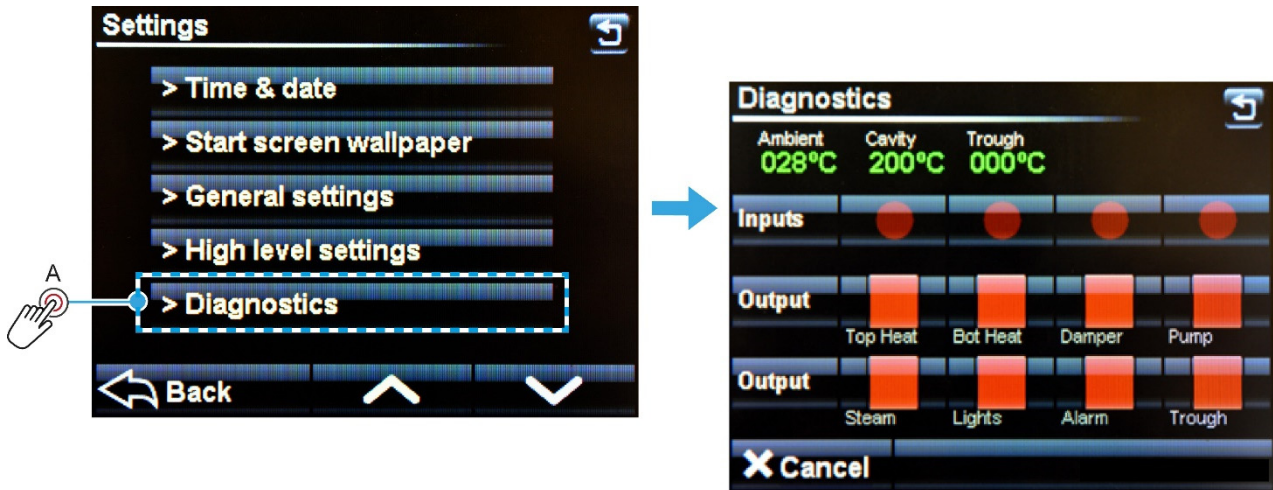
These files contain the information for baking each product, e.g. bread, buns, and cakes.

Startup screens

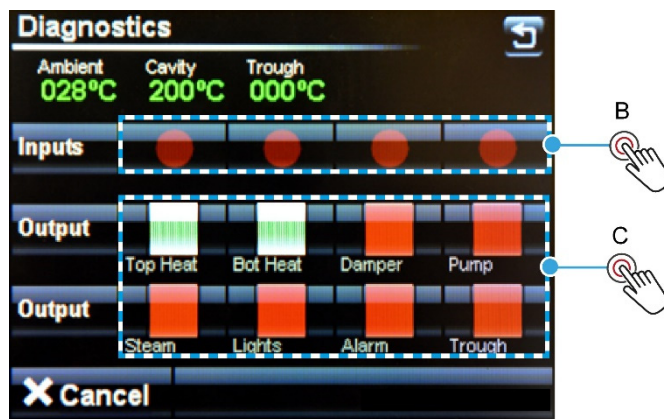
These files show a picture or logo when the oven starts or wakes up.

5.16. Diagnostics

1. Touch **Settings** on the main option screen.
2. Touch Diagnostics (A) to open the diagnostics display.



3. Inputs (B) are highlighted when a signal is received, e.g. a door is open.
4. Touch the required output (C) and a signal is sent to that item.
 - The output being checked is highlighted when active. To stop the output, touch it again.



6. Cleaning

6.1. Safety messages

**WARNING**

- Ensure the oven is switched off at the power socket and completely cooled before cleaning.
- Be aware that the surfaces of the oven can remain hot for several hours. Wear protective gloves and appropriate clothing when cleaning.
- Do not remove any covers, panels, or pipe fittings for cleaning.
- Do not clean the oven while it is powered or operating.

6.2. Daily cleaning

Before undertaking this task, ensure the oven is disconnected or isolated from the electrical supply and that the oven and elements are completely cold.

Daily cleaning tasks

1. Sweep any debris out of the oven after it has been allowed to cool.
 - Cooling down could take several hours.
 - Use a vacuum cleaner if necessary, **but only when the oven is completely cold.**
2. Wipe the oven front, back and sides with a damp cloth.
3. Spot clean outside with a damp cloth, soaked in a solution of mild detergent and hot water.
 - Pay particular attention to ensure excess water is not applied near electrical panels.

6.3. Weekly cleaning

Before undertaking this task, ensure the oven is disconnected or isolated from the electrical supply and that the oven and elements are completely cold.

Weekly cleaning tasks

1. Complete the daily cleaning procedure.
2. Clean any burnt-on debris by scrubbing it with a stiff brush and, if necessary, a damp cloth.
3. Use a nylon brush to scrub the wheels with a mild detergent and hot water.
 - Using too much water eventually rusts the metalwork.

7. Troubleshooting Bakes

None of the decks are switched on.

- Is the oven's main isolator switch set to the ON (I) position?
- Check if the time clock of the bakery's mains power supply is working (if fitted).
- Is the clock set correctly to power the oven on the required day and time?

One deck is not switched on.

- Check if the individual deck timer is set for a specific time.

Uneven or patchy bake.

- If the front is pale and the back is burnt, the doors may have been opened too often or left open for too long during loading.
- Uneven loading.
- Faulty element.
- Top or bottom deck elements are not functioning.
- There is no supply voltage across one of the three phases.

The actual temperature far exceeds the set temperature.

- When empty, the temperature of a deck oven can exceed the set baking temperature. This overheat is marginal when the deck is full of products. If the elements continue to heat after reaching the set temperature, call MONO Equipment for technical assistance. (Please allow up to 15 °C (59 °F) difference before diagnosing a fault condition).

Heat recovery is poor after loading the oven.

- Doors may have been left open for too long during loading and allowed heat to escape.
- The Damper may have been left open during loading/baking, allowing heat to escape.
- The top or bottom heat may not be working.
- There is no supply voltage across one of the three phases.

The steam system is not operating correctly.

- Is the water supply connected correctly?
- Is the tap to each deck in the ON position?
- Has enough time elapsed since the last steaming? Once steamed, the oven does not steam until the steam unit has recovered heat, typically 3 to 10 minutes depending on the program selected.

8. Service

If a fault arises, please do not hesitate to contact MONO Equipment's Service and Spares department. Be prepared to provide the Serial Number from the machine's information plate or the front page of this User Manual in all communications.

8.1. Contact information for customer services

MONO Equipment Limited

Queensway
Swansea West Industrial Park
Swansea
SA5 4EB
United Kingdom
www.monoequip.com

Contacts

spares@monoequip.com
+44 (0)1792 564039

techsupport@monoequip.com
+44 (0)1792 564041

service@monoequip.com
+44 (0)1792 564048

Switchboard
+44 (0)1792 564039

8.2. Further information

Visit MonoEquip.com for the latest versions of this user manual. Also find up-to-date information about all MONO's products.

8.3. Environmental disposal

Dispose of the machinery with care when it comes to the end of its working life. Use the most environmentally friendly manner possible by recycling or other means of disposal which complies with local regulations. Only dispose of the machine safely and legally. The Environmental Protection Act 1990 applies in the United Kingdom.

9. Maintenance

9.1. Safety messages

**WARNING**

- Always disconnect or isolate the electrical supply before starting any maintenance work on the oven.
 - Some components stay electrically energised even after the main isolator is in the 0 (OFF) position.
-

**WARNING**

- The Fan Assisted Deck Oven must be maintained at regular intervals. The frequency of maintenance will depend upon your specific use and location. The maximum service interval should be 12 months.
 - Service and maintenance should only be undertaken by suitably qualified and experienced persons (SQEP).
 - You must immediately report any damage or defect arising with the appliance.
 - Unsafe equipment is dangerous. Do not use the appliance. Isolate the electrical supply and contact MONO Equipment Limited or your appointed service agent.
-

9.2. General maintenance

The following general maintenance is recommended:

- Check for any visible damage or signs of tampering.
 - Do not use the machine if it is clearly damaged, i.e. frayed or bare wires are visible.
 - Report the damage but do not attempt to make any repairs yourself.
- Follow the cleaning instructions in [Chapter 6](#).

9.3. Preventative maintenance

The following preventative maintenance schedule is recommended.

Every 3 months

- Door pivot:
 - Lubricate the door pivot with heat resistant grease.

Every 12 months

- Door seals:
 - Do a visual check to ensure the door seals are in good condition.
 - Arrange for a suitably qualified and experienced person to replace them if necessary.
- Damper function:
 - Do a visual and auditory check to confirm if it opens and closes.
 - Arrange for a suitably qualified and experienced person to investigate and make repairs if necessary.
- Water hose connectors:
 - Do a visual check for signs of water leakage.
 - Tighten the connectors.
 - Replace the water hose if necessary.
- Solenoid valve operation (only if the oven has a steam function):
 - Do a visual and auditory check to test if steam is being generated.
 - Arrange for a suitably qualified and experienced person to investigate and make repairs if necessary.
- Condition and functioning of the heating elements:
 - Do a visual check for any signs of damage.
 - Arrange for a suitably qualified and experienced person to replace damaged elements.
- Fan motor bearings:
 - Do an auditory check to hear if there are any unusual sounds made when the fan is functioning.
 - Arrange for a suitably qualified and experienced person to investigate and make repairs if necessary.
- Baking tiles:
 - Check for any cracks or warping.
 - Arrange for a suitably qualified and experienced person to replace damaged baking tiles.
- General functioning of the oven:
 - Confirm the general functioning of the oven is as expected, e.g. the control panel is not 'freezing' and the oven is not underbaking or overbaking product.

10. Spares

Table 10.1: Fan Assisted Deck Oven spare parts

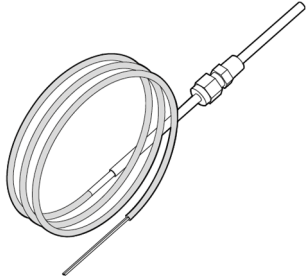
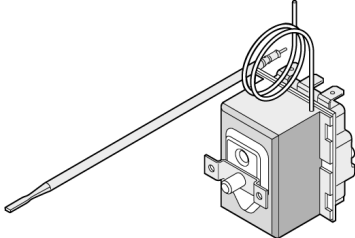
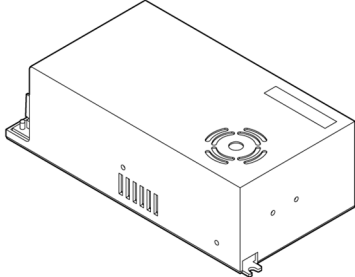
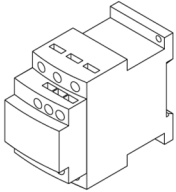
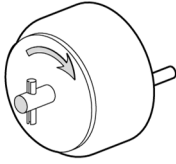
Part number	Item description	Quantity	Image
B873-95-007	Oven thermocouple	1	
B872-22-009	Heater MCB	1	Image not available
B888-30-014	Overheat thermostat	1	
B872-22-061	Cooling fan MCB	1	Image not available
B801-93-004	Control circuit power supply	1	
B801-08-021	Top heat contactor	1	
B801-08-021	Bottom heat contactor	1	
B867-83-009	Water solenoid	1	Image not available
B749-83-003	Damper solenoid (L/H oven)	1	

Table 10.1: Fan Assisted Deck Oven spare parts (continued)

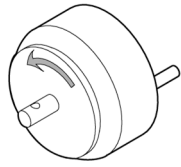
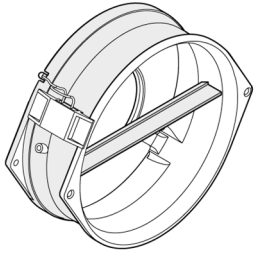
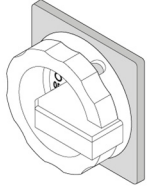

Part number	Item description	Quantity	Image
B749-83-004	Damper solenoid (R/H oven)	1	
B869-75-032	Cooling fan	1	
B851-07-002	Mains isolator switch	1	
158-25-80000	Eco-touch screen and PCB assembly	1	
B854-04-004	Heating element, 0.6 kW	1	Image not available
B854-04-092	Heating element, 0.75 kW	1	Image not available
B854-04-093	Heating element, 1 kW	1	Image not available

Figure 10.1: M246-02-00385 Fan Assembly

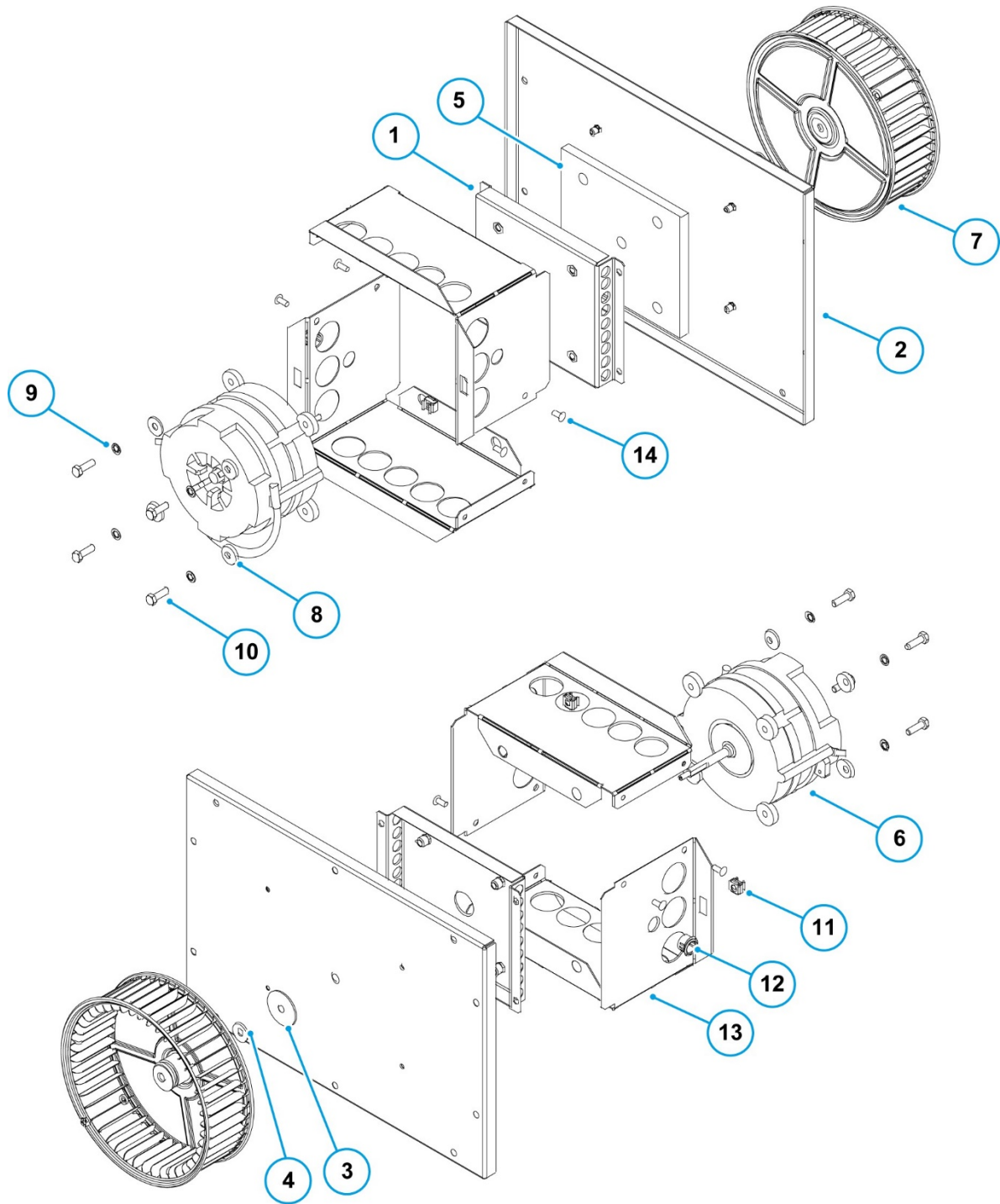
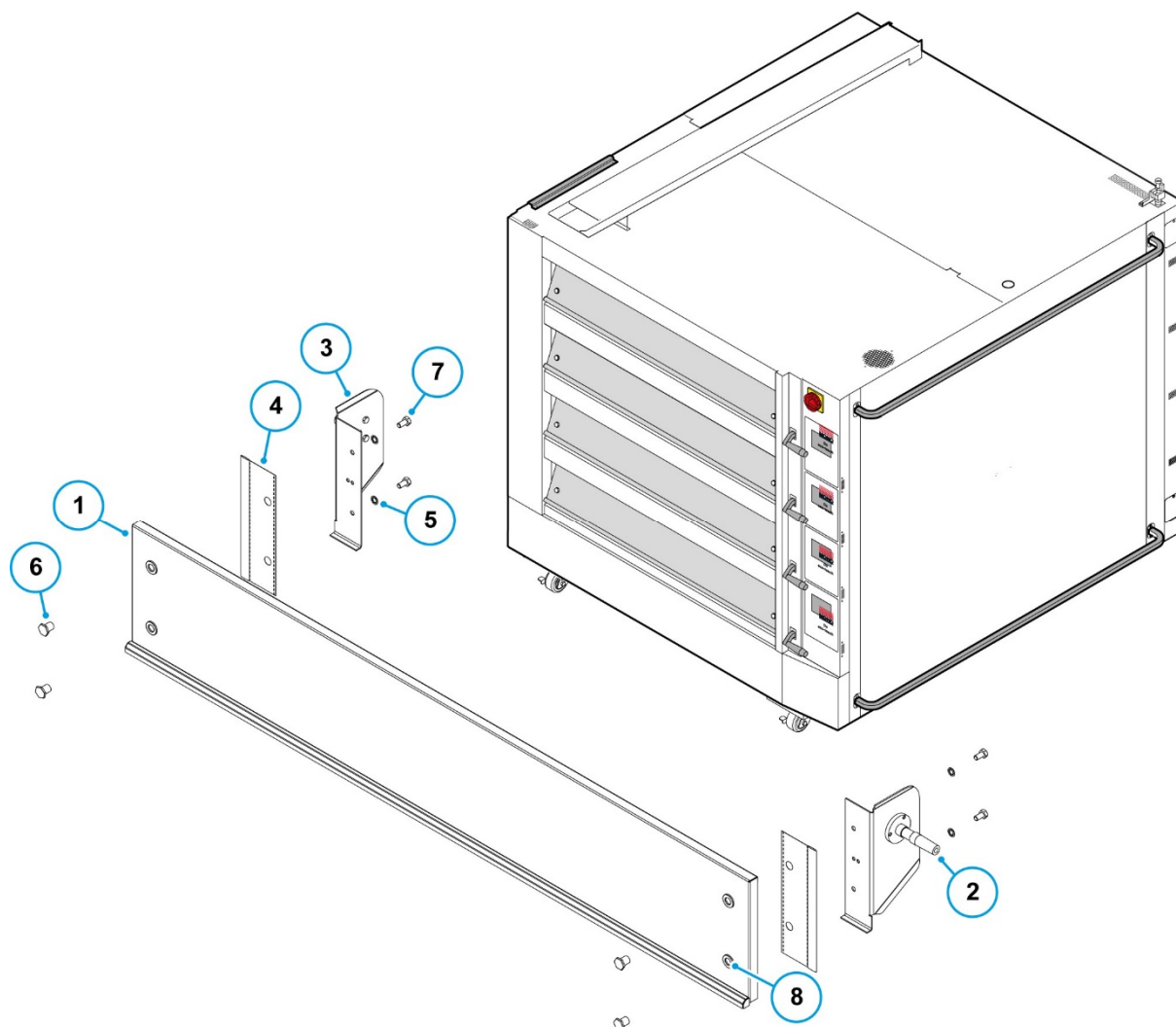


Table 10.2: Parts list for M246-02-00385 Fan Assembly

Item No.	Part number	Description	Quantity
1	245-02-34600	Motor plate	1
2	246-02-00382	Fan mounting plate	1
3	148-02-04000	Motor shaft seal	1
4	148-02-00500	Fan double D spacer washer	1
5	246-02-00384	Fan insulation panel	1
6	B720-74-004	Single-phase motor	1
7	A900-27-222	Fan	1
8	A900-05-180	¼-inch plain washer	4
9	A900-05-163	M6 shake-proof washer	4
10	A900-03-379	M6x20 hexagonal bolt	4
11	A900-01-305	M6 caged nut	2
12	B811-49-002	Snap bush	1
13	246-02-00357	Fan box	2
14	A900-01-301	Pop rivet 4.8 dia x 11.25 LG	4
15	A900-05-168	M5 plain washer	1
16	A900-04-072	Binx M5 nut, steel plated	1

Figure 10.2: M246-00-00010 Door Assembly**Table 10.3:** Parts list for M246-00-00010 Door Assembly

Item No.	Part number	Description	Quantity
1	245-03-22536	Fabricated metal door	1
2	245-03-22539	Hinge assembly (right-hand door)	1
3	45-03-22550	Left-hand hinge plate, hinge block and screws	1
4	245-03-00400	Side seal	2
5	A900-05-174	Shakeproof washer, M8	4
6	257-03-00018	Door retainer	4
7	A900-03-430	Hex bolt, M8x16	4
8	A900-05-268	M12 Washer, form A, A2 stainless steel	4

A. Passcodes

A.1 Default passcodes

Table A.1: Default passcodes

Security access	Default passcode
Supervisor (low level)	123456
High level	654321
Master	314159 (fixed)

Suggestion

To stop unauthorised changes to the oven setup, it is suggested that this page is redacted or removed from this manual and kept in a safe place for future reference.

If tampering could be a problem, it is also a good idea to change the passcodes at regular intervals.

(Intentional Blank Page)

B. Dimensional Drawings

B.1 Deck oven dimensions

Height	1859 mm (73.2 inches) - with 75mm trolley (no castors or flue)
	2055 mm (81 inches) - without canopy but including flue
	2245 mm (88½ inches) - with canopy
	2509 mm (99 inches) - with canopy and extractor
Width	1975 mm (77¾ inches) - without bumper bars
	2075 mm (81¾ inches) - with bumper bars
Depth	2140 mm (84¼ inches)
Crown height	203 mm (8 inches)
Internal deck height	188 mm (7½ inches)
Internal useable area	2.26 m ² (24⅓ ft ²)
Bottom deck loading height	533 mm (21 inches)
Top deck loading height	1590 mm (62½ inches)

Figure B.1: Overall dimensions of the oven

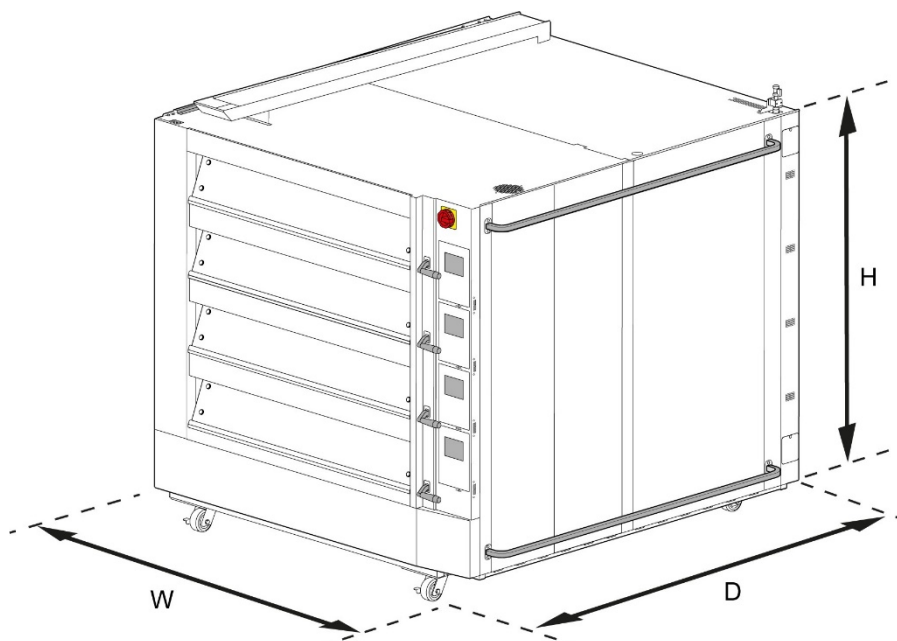
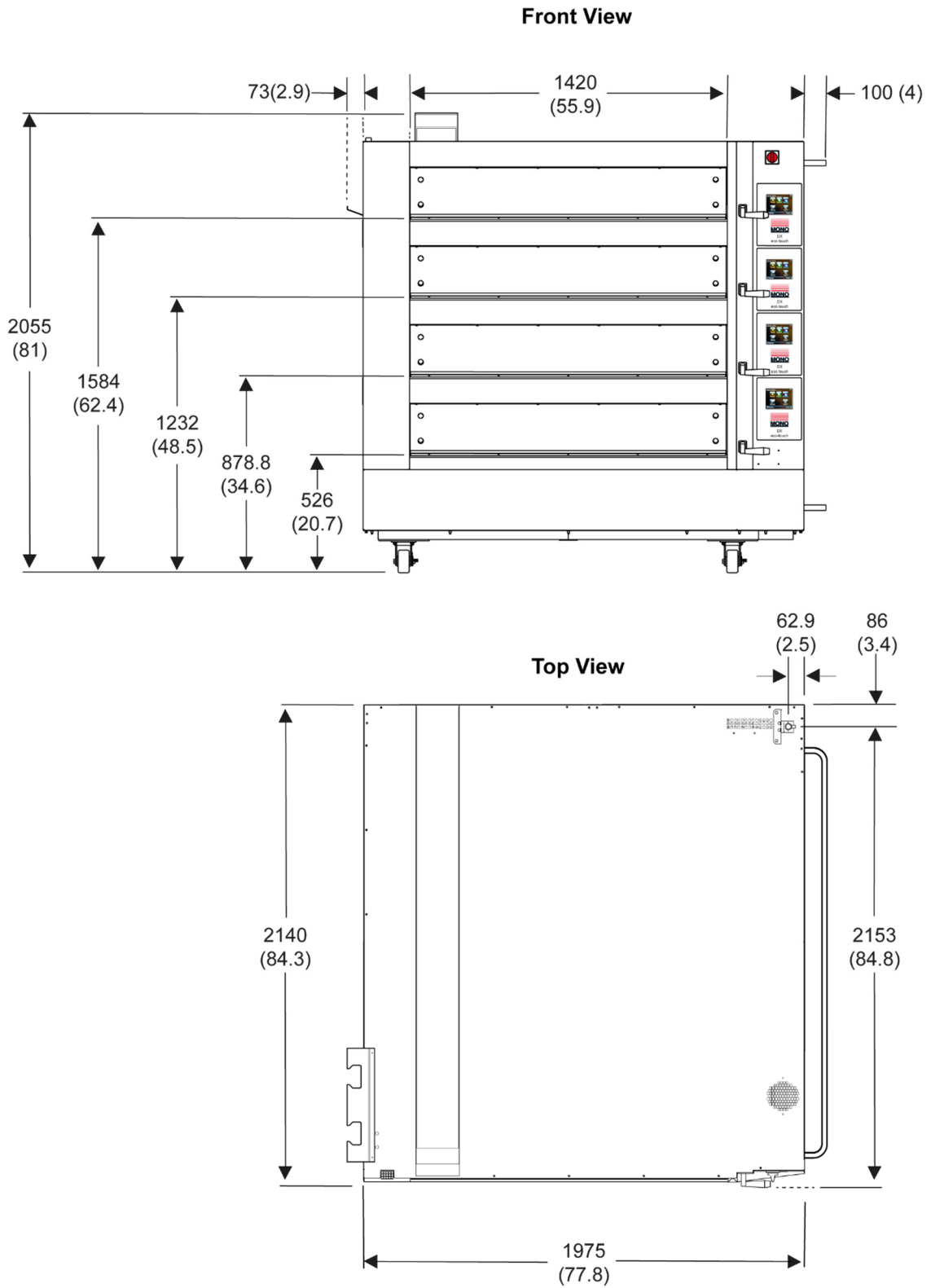
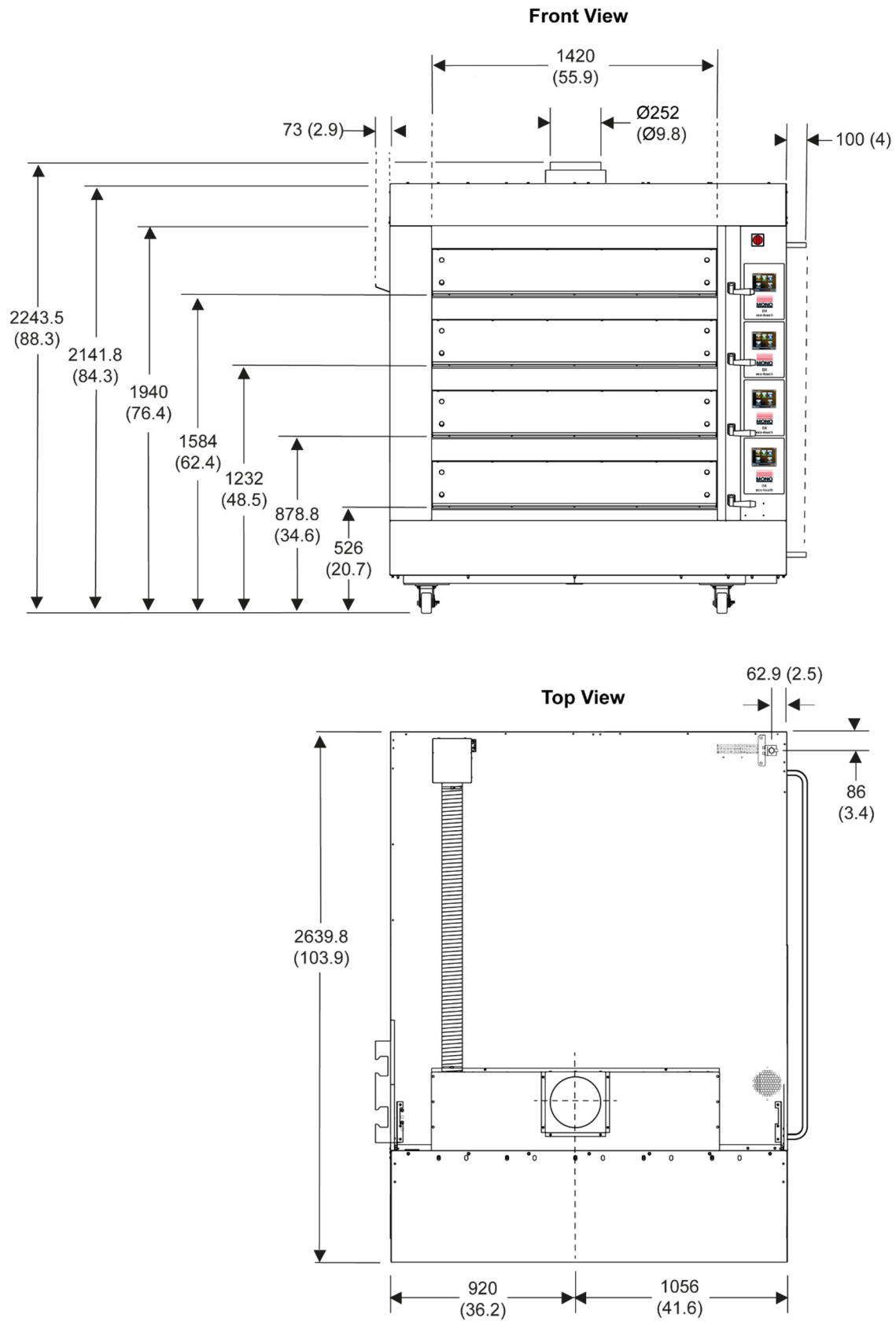


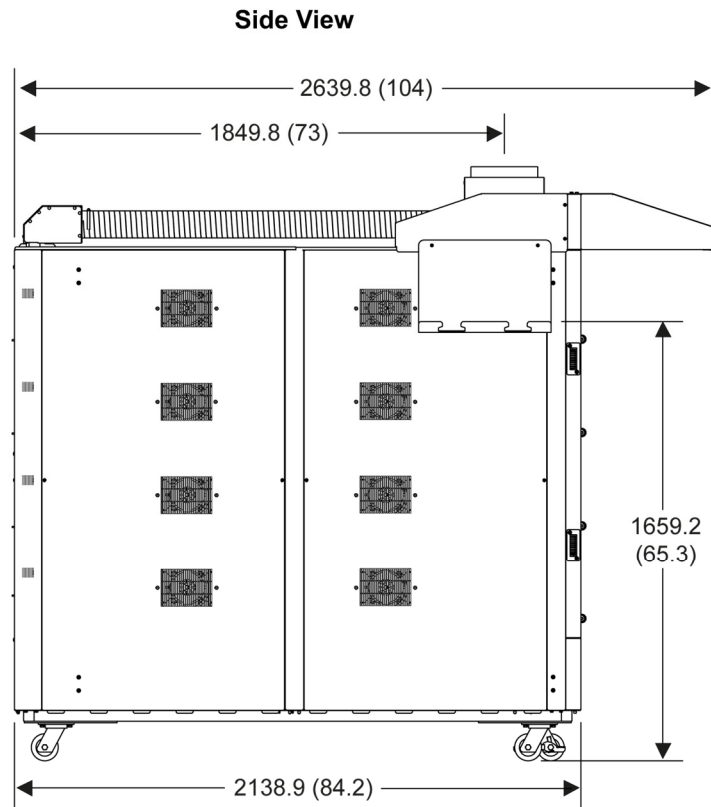
Figure B.2: Oven with four decks and without a canopy fitted



3 trays wide x 2 trays deep nominally per deck.
 Dimensions are in mm (inches).

Figure B.3: Oven with four decks and with a canopy fitted





3 trays wide x 2 trays deep nominally per deck.
Dimensions are in mm (inches).

C. Specifications

C.1 Electrical specifications



WARNING

- Only fully trained and authorised persons are permitted to install the oven.
- There should always be a local disconnection switch for any person to isolate the electrical power in an emergency. The disconnection switch must be visible, labelled as an emergency shutdown device, and easily accessible.
- It is recommended that a qualified and competent electrician first tests the electrical outlet (power socket) for electrical safety. All electrical work must be in accordance with local and national regulations.
- Always check the electrical requirements on the machine's information plate before connecting the power for the first time. Contact MONO Equipment if the electrical information is not correct for your site.
- Always ensure your hands are dry before touching any electrical components, including cables, switches, and plugs.

Power supply

See [Table C.1](#) for supply options.



The supply to this machine must be protected by a 30mA-rated Type A Residual Current Device (RCD) prior to installation and commissioning.

Power cable

Not supplied or fitted by MONO (M50 cable gland and locking nut provided)

Electrical panel

Membrane-operated touchscreen

Table C.1: Single supply specifications

Oven version	Voltage	Phase	Current	Total Power
Standard	415 Vac (50 Hz)	Three-phase +N +E	100 Amps supply required ⁽¹⁾	59 kW

(1) Nominal consumption is 83 Amps.

C.2 Environmental specifications

Noise level

The noise level is less than 80 dB.

C.3 Mechanical specifications

Features

Number of decks	4
Fan-assisted technology	Yes (2 fans per deck)
Full-colour touchscreen display	ECO Touch control panels (1 per deck) Panels can be on the left or right.
Sole plate	Solid, heavy composite sole plate
Connections	Electrical (single-point connection) Water (single-point connection) No drainage is required.
Insulation	RW5 solid slab insulation Superwool-insulated stainless steel doors
Doors	Magnetic door closures Interlocked door/fan safety switch
Safety	Emergency isolator switch Lockable castor wheels

Number of trays per deck

600 mm x 800 mm (portrait)	4
600 mm x 400 mm (portrait)	8
18 in. x 30 in. (portrait)	6
18 in. x 26 in. (portrait)	6
600 mm x 400 mm (landscape)	6

Optional extras

Canopy only	Yes
Canopy with extractor fan	Yes
Protective side bumper bars	Yes
Double peel holder	Yes
Water softening unit	Yes

C.4 Functional specifications

Energy saving	Sleep mode and Auto-shutdown
Maximum number of programs	240
USB programmable	Yes (dedicated USB port for data only)
Customisable wallpaper	Yes (displayed in Sleep and Standby modes)
Manual baking mode	Yes (selectable on HOME screen)
Favourites menu	Yes (selectable on HOME screen)
7-day, 24-hour timer	Yes (selectable on HOME screen)
8-hour countdown timer	Yes
Full-load and Half-load options	Yes
Phases during bake program	Up to 6
Fan speed	Programmable for each baking phase
Heat	Independent top and bottom heat Programmable for each baking phase
Steam	Integrated steam generating system Pre-steam function
Damper	Programmable damper function
Diagnostics	Diagnostic screens for troubleshooting and testing

D. Electrical Information

D.1 Electrical drawings and parts lists

Table D.1: Parts list for electrical drawings

Item No.	Part number	Description
B1	B873-95-007	Oven thermocouple
C1 and C2	B842-23-013	Motor capacitors
D1	B842-07-037	Door switch
F1, F2, and F3	B872-22-009	Heater MCB
F4	B872-22-001	Cooling fan MCB
F5	B872-22-062	Control circuit – Power Supply Unit (PSU) – MCB
F6	B888-30-014	Overheat thermostat
F7	B872-22-063	Deck fans MCB
H1, H2	B855-94-005	Interior light (option)
K1	B801-08-021	Top heat contactor
K2	B801-08-021	Bottom heat contactor
K3	B801-08-021	Steam trough heat contactor
M1	B869-75-001	Cooling fan
M2, M2	B720-74-004	Deck fans #1 and #2
P1	B801-93-043	Power supply
Q1	B851-07-002	Mains isolator
R1	B723-37-001	Fan motor #1 forward relay
R2	B723-37-001	Fan motor #1 reverse relay
R3	B723-37-001	Fan motor #2 forward relay
R4	B723-37-001	Fan motor #2 reverse relay
S1, S2, S3, S4	B482-48-022	Supressors
U1	158-25-80000	Main PCB Controller
X1	B723-92-002	Audible sounder (option)
Y1	B867-83-009	Water solenoid
Y2	B749-83-003	Damper solenoid, right-hand
	B749-83-004	Damper solenoid, left-hand
Element A	B854-04-093	Heating element, 1 kW
Element B	B854-04-004	Heating element, 0.6 kW
Element C	B854-04-092	Heating element, 0.75 kW

Figure D.1: M246E25-04000 Convection deck heating element wiring (3-Tray Wide)

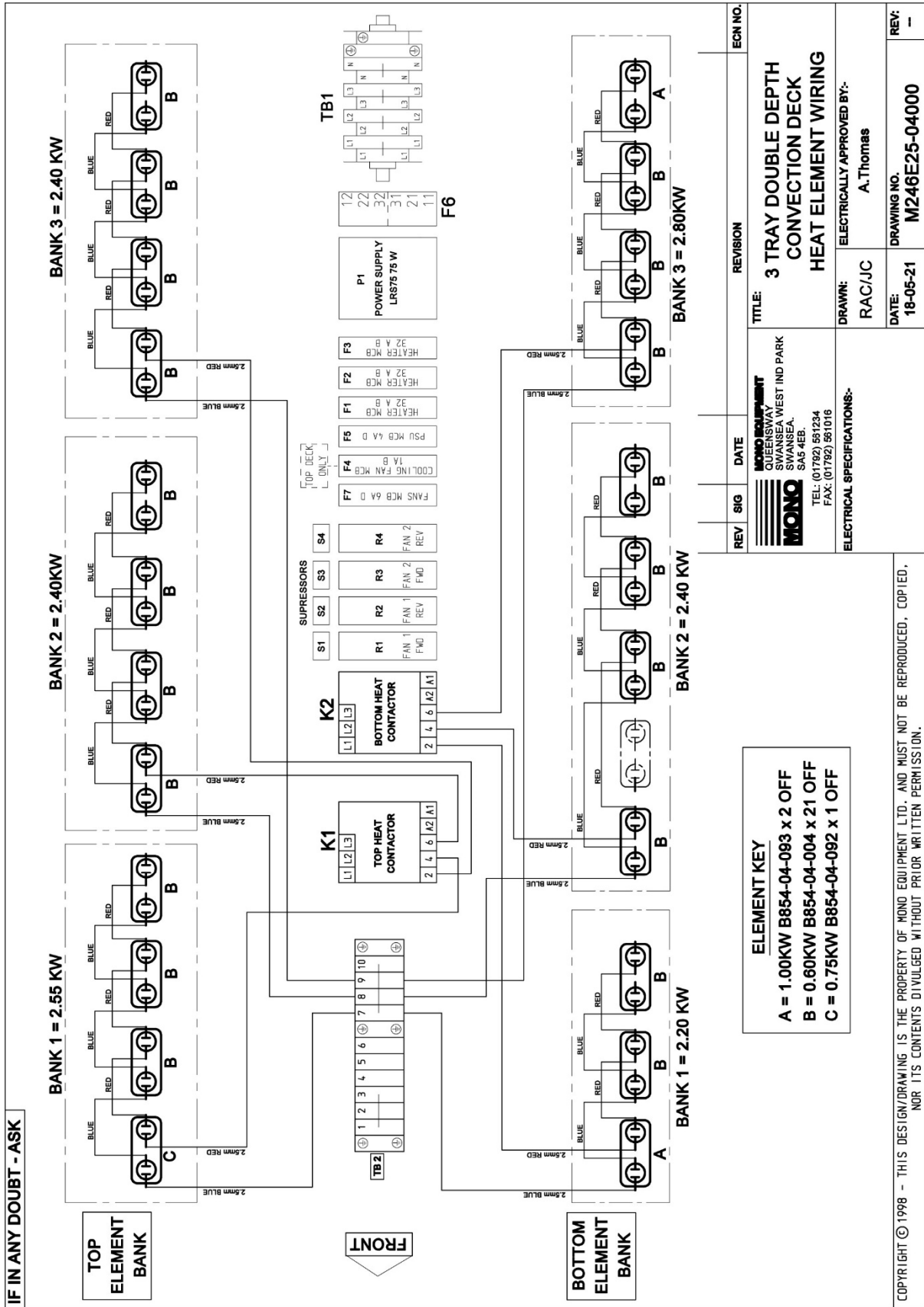


Figure D.3: M246E25-04100 Control circuit / fans power circuit

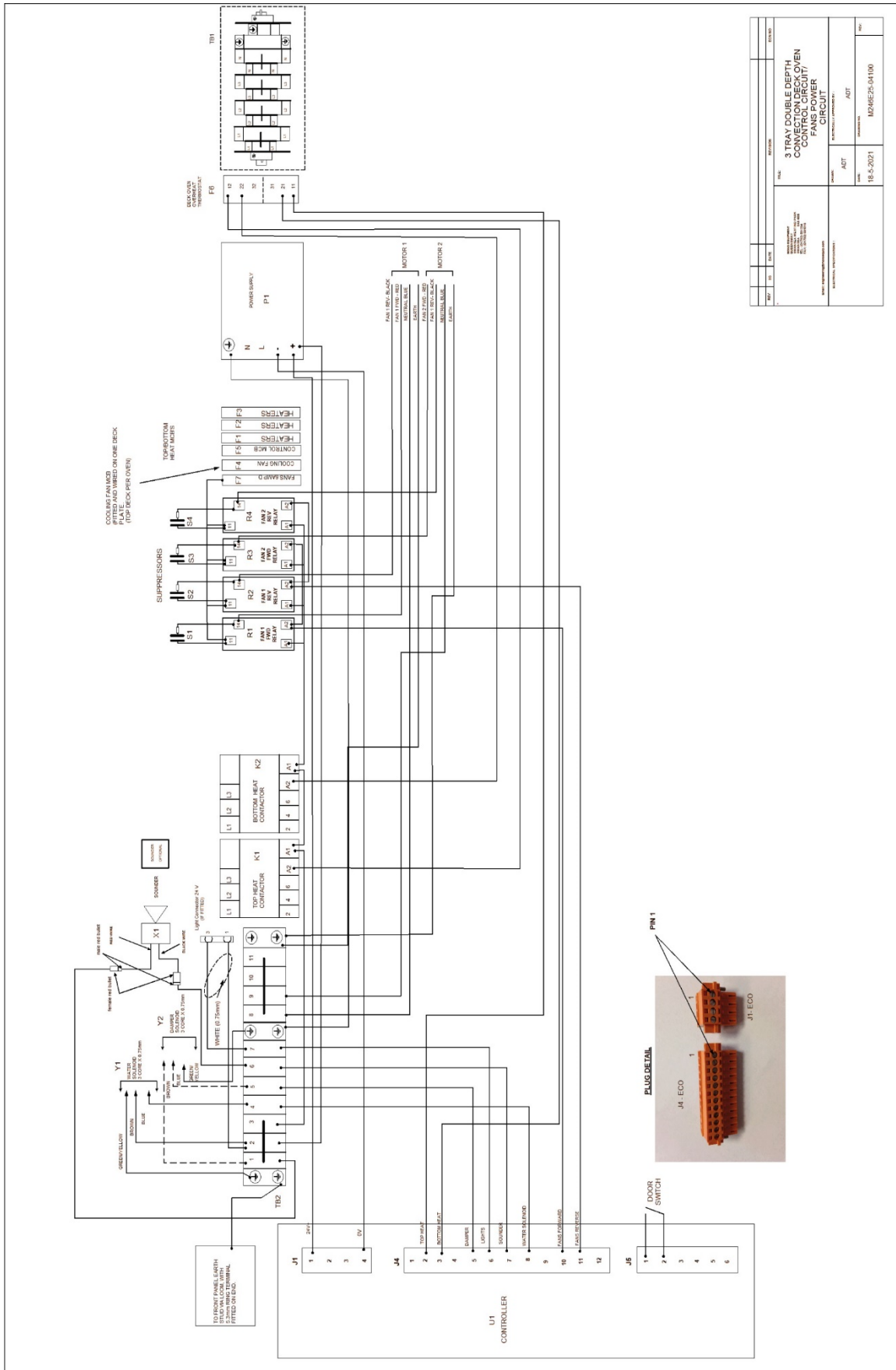
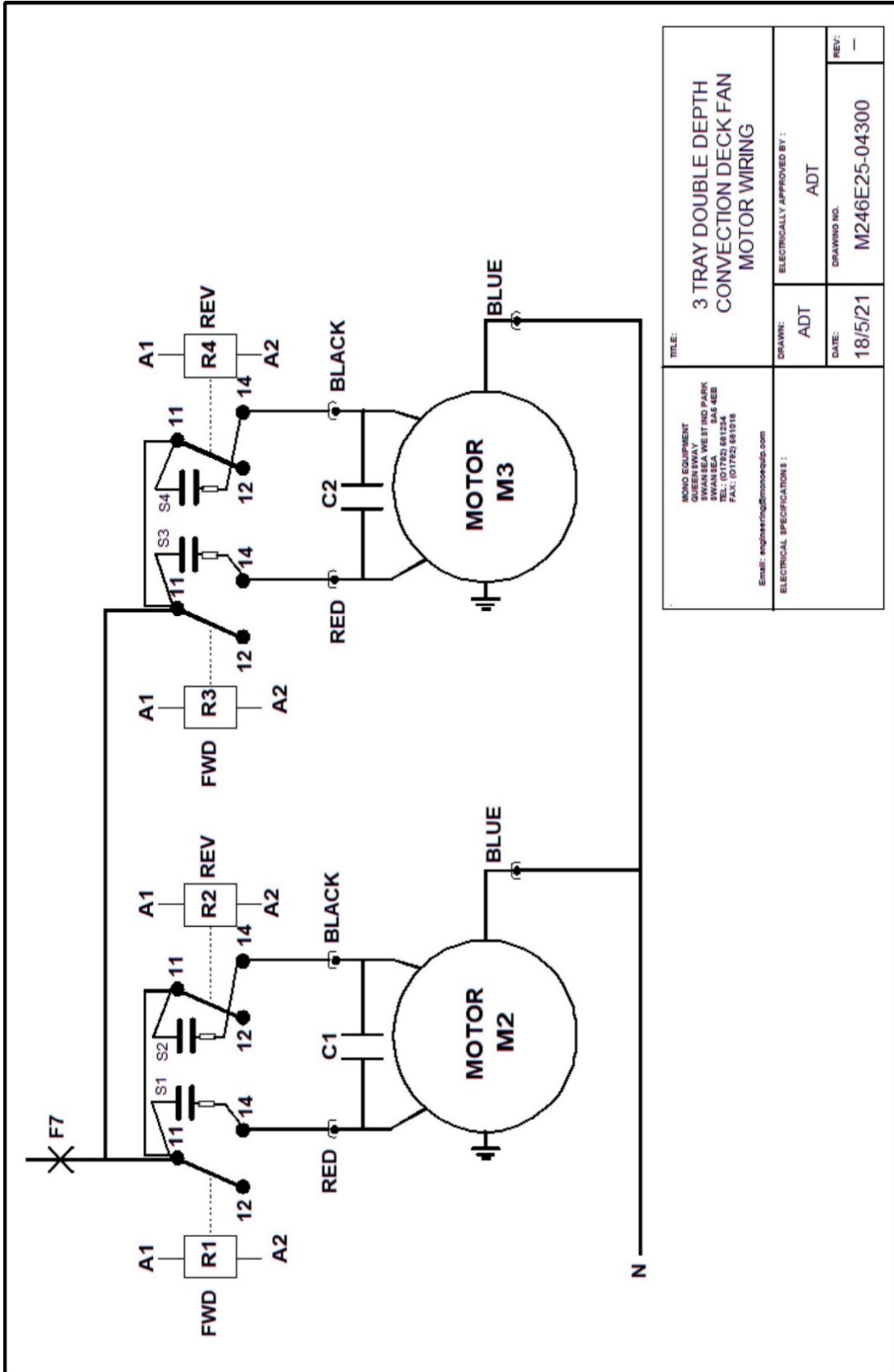


Figure D.4: M246E25-04300 Convection deck fan motor wiring

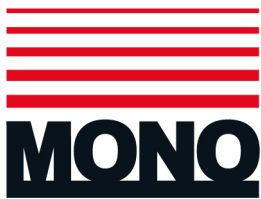


MONO EQUIPMENT GUREN SWAY 174 WILMA WEST RD SWANSEA MA 01934 TEL: (01782) 681234 FAX: (01782) 681018 Email: engineering@monoequip.com		TITLE: 3 TRAY DOUBLE DEPTH CONVECTION DECK FAN MOTOR WIRING	
ELECTRICAL SPECIFICATIONS :		DRAWN: ADT	ELECTRICALLY APPROVED BY : ADT
		DATE: 18/5/21	DRAWING NO. M246E25-04300
		REV:	—

MONO Equipment is the leading designer and manufacturer of bakery equipment in the United Kingdom. This proud heritage of British craftsmanship, combined with a reputation for creating high-quality, innovative products, can be traced back to its origins in 1947.

All our bakery equipment is manufactured to the most stringent NQA ISO9001:2015 & NQA ISO14001:2015 standards and is crafted using the very latest, cutting-edge technology combined with the time-honoured skills of the master craftsman.

MONO Equipment truly excels in providing tailor-made solutions to a diverse range of clients, from the small independent artisan baker to the large retail chains found on every high street and in every out-of-town shopping centre. We can supply everything from a simple Food-2-Go cafe oven to the entire list of bakery equipment needed to set up a full scratch bakery.



MONO Equipment Limited

Queensway
Swansea West Industrial Park
Swansea
SA5 4EB

Tel: +44 (0)1792 561 234 (Switchboard)
Tel: +44 (0)1792 564 000 (UK Sales)
Tel: +44 (0)1792 564 004 (International Sales)
Tel: +44 (0)1792 564 048 / +44 (0)1792 564 049 (Spares)
Fax: +44 (0)1792 561 016

Email: sales@monoequip.com
web: www.monoequip.com



*Scan using your smart
phone to view our website*

