

MONO Harmony Deck Oven

EN

Installation and Operation Manual



Product Version

- UK specification
- Modular decks
- ECO Touch controller

Enter Serial Numbers here

Deck 1
Deck 2
Deck 3
Deck 4
Deck 5
Fan (If fitted)

In the event of an enquiry please quote these serial numbers.



DECLARATION OF CONFORMITY

We hereby declare that this machine complies with the essential health and safety requirements of :-

- The Machinery Directive 2006 / 42 / EC
- The Low voltage Directive 2006 / 95 / EC
- The requirements of the Electromagnetic Compatibility Directive 2004 / 108EC, 91 / 263 / EEC, 92 / 31 / EEC
- The General Safety of Machinery and food processing Standards applicable
- Materials and Articles intended to come into contact with food - Regulation (EC) No. 1935 / 2004
- Good manufacturing practice for Materials intended to come into contact with food - Regulation (EC) No. 2023 / 2006

Signed	
D. Osmundsen – Quality and Conformance Manager	

Date	
-------------	--

Machine FG Code.		Machine Serial No.	
-------------------------	--	---------------------------	--

A technical construction file for this machine is retained at the following address:

MONO EQUIPMENT
 Queensway,
 Swansea West Industrial Park,
 Swansea
 SA5 4EB
 UK

MONO EQUIPMENT is a business name of **AFE GROUP Ltd**
 Registered in England No.3872673 VAT registration No.923428136

Registered office: Unit 35,
 Bryggen Road,
 North Lynn Industrial Estate,
 Kings Lynn Norfolk,
 PE30 2HZ

Safety Symbols

The following safety symbols are used throughout this product manual. Before using your new equipment, read the instructions carefully and pay special attention to the information marked with the following symbols:

**DANGER**

Indicates an immediate hazard with a high risk of death or serious physical injury if not avoided.

**WARNING**

Indicates a potential hazard with a medium risk that could result in death or serious physical injury if not avoided.

**CAUTION**

Indicates a hazardous situation that could result in minor or moderate injury if not avoided.

Electrical Safety Notice



Electrical safety and advice regarding supplementary electrical protection

Commercial kitchens and food service areas are environments where electrical appliances may be located close to liquids, operate in and around damp conditions or where restricted movement for installation and service is evident.

The appliance installation and periodic inspection should only be undertaken by a qualified, skilled, and competent electrician and connected to the correct power supply suitable for the load as stipulated by the appliance data label.

The electrical installation and connections should meet the mandatory requirements of the local electrical wiring regulations and any safety guidelines.

We recommend:

- Supplementary electrical protection with the use of a residual current device (RCD)
- Fixed wiring appliances should also incorporate a locally situated switch disconnector to connect to, which is easily accessible for switching off and safe isolation purposes. The switch disconnector must meet the specification requirements of IEC 60947.

Your attention is drawn to the following:

BS 7671:2018 – Guidance Note 8 – 8.13: Other locations of increased safety risk

It is recognised that there may be locations of increased risk of electrical shock other than those specifically addressed in Part 7 of BS 7671. Examples of such locations could include laundries, where washing and drying machines are nearby, and water is present, and commercial kitchens with stainless steel units where, once again, water is present. Where, because of the perception of additional risks being likely, the installation designer decides that an installation or location warrants further protective measures, the options available include:

- Automatic Disconnection of Supply (ADS) using a residual current device having a residual operating current not exceeding 30 mA;
- Supplementary protective equipotential bonding; and
- Reduction of maximum fault clearance time.

The provision of RCDs and supplementary bonding must be specified by the host organisation's appointed installation designer or electrical contractor and installed by a suitably qualified and competent electrician to comply with Regulations 419.2 and 544.2.



WARNING

- The supply to this machine must be protected by a 30mA-rated Type 'A' Residual Current Device (RCD).
 - Before installation, it is recommended that a qualified and competent electrician first tests the electrical outlet for electrical safety.
-

Water Leak Safety Notice

**WARNING**

- **Take action immediately to get a water leak fixed and prevent death or serious injury from electrocution.**
-

It is essential to regularly check for any signs of a water leak from an oven installation. If there is evidence of a water leak, do not ignore it. Immediately report it to a manager or as applicable to your organisation.

Furthermore:

- Disconnect or completely isolate the oven from the electrical supply (see **Emergency Instructions** section on page 18).
- Place an out-of-service notice on the oven.
- Contact your oven supplier or MONO Equipment for technical assistance.

Ovens must be maintained and serviced at appropriate intervals to ensure the oven operates at optimum levels. See the **Maintenance** section on page 65.

General Notices

**CAUTION****■ Users with Implantable Cardioverter Defibrillators and Pacemakers**

- Several common types of devices and machinery may interfere with implantable cardioverter defibrillators (ICDs) and pacemakers, including mobile phones, headphones, radios, machinery, and magnets.
 - The electromagnetic waves generated by these devices can keep your ICD or pacemaker from functioning correctly. Try to avoid them, or at least minimise your exposure to them.
 - Your healthcare professional can advise you about specific devices and machinery to avoid.
-

**NOTICES****■ Warranty information**

- Ambient working temperatures for electrical components, such as solenoid switches, circuit breakers and motors, should not exceed 40 °C (115 °F). Manufacturers of these, and other electrical components, advise that any ambient temperature above this affects the functionality of the components. Any related guarantees become void.
- It is the owners' responsibility to ensure adequate ventilation is provided. Any component malfunctioning during the guarantee period found to have been subjected to excessive humidity or ambient working temperatures is not covered by the component manufacturer's or MONO Equipment's product warranty.
- Failure to adhere to the cleaning and maintenance instructions detailed in this User Manual also could affect the warranty of this machine.
- Visit the [MONO Parts and Labour Warranty page](#) for further information.

■ Continuous improvements

- Our policy is to improve our machines continuously, and we reserve the right to change specifications without prior notice.

■ Engineers/Electricians-only sections of the User Manual

- Technical sections of this User Manual are for suitably experienced and qualified persons (SEQP) only. Customers must never make any modifications or repairs to MONO's machines.
-

Contents

	Page
1. Introduction	9
2. Overall Dimensions	10
Overall dimensions (standard-size decks)	10
Overall dimensions (compact decks).....	10
3. Specifications	11
Electrical specifications	11
Environmental specifications	11
Mechanical specifications	11
Standard-size deck oven dimensions	12
Compact deck oven dimensions	15
4. Safety	16
Safety messages	16
Emergency instructions	18
5. Installation	19
General	19
Electrical connections	19
Fit the earth straps (part no. 158-25-11200).....	19
Fit the tile retaining brackets (part no. 257-06-00015)	20
Water supply requirements	20
Water system setup procedure.....	21
Exhaust Connections (if canopy fitted)	22
6. Before First Use of the Deck Oven	24
Operating conditions	24
Baking tile ‘seasoning’ instructions.....	25
Baking principles	26
7. Operating Instructions	28
Basic operation	29
Baking using the “Favourites” menu	30
Baking using the “Manual Bake” menu	33
Baking using the "Programmes" menu	36
Creating a bake program	39
7-day timer	46
Settings7	47
8. Using the USB Port	53
9. Diagnostics	57
10. Passcodes	59

- 11. Cleaning 61**
 - Daily cleaning instructions..... 61
 - Weekly cleaning instructions..... 61
- 12. Troubleshooting 62**
- 13. Service 63**
 - Oven spares 63
 - Service Information 64
 - Disposal..... 64
- 14. Maintenance..... 65**
 - General maintenance 65
 - Light bulb replacement..... 65
- 15. Oven Electrics 67**
 - Electrical drawings..... 70
 - Electrical panel main components 77
- 16. Warning and Information Labels..... 79**

1. Introduction

The electric modular Deck Oven is an easy-to-use practical, good-looking oven, giving an excellent heat recovery rate and an even bake across a wide range of bread and confectionery products.

■ **Good looking and completely reliable**

Conceived with the no-nonsense requirements of both the independent and in-store baker in mind, designed to be visually pleasing and give reliable service for many years visually. This oven will more than satisfy the most discerning customer.

■ **Top-quality specification**

The external and internal contact surfaces are stainless steel.

Each modular deck has one or more durable reinforced tiles, high-grade insulation, and high-temperature ceramic sealant to make the oven more efficient.

The oven comes with a patented integral steaming system, which reduces energy consumption and the overall size of the oven. The system produces natural steam with the advantages of spray steam. Pre-steam is also available to reduce the effects of long loading times. No drainage is required.

Eco-touch ovens are supplied with **TOUCH** displays for user-friendly control panels. The displays can show pictures of product types or program numbers to meet the bakery's requirements. When not being used, the screen can show a company logo. A voice-prompt facility is also available for basic instructions such as "Bake over".



ECOTOUCH
SCREEN
CONTROLS



The lights are low voltage, sealed from the chamber and easily accessed from outside the oven.

Fitted with a choice of hinged easy to clean double-glazed doors (using low energy-loss reflective glass for high visibility) or metal doors, means low energy consumption and the high kW rating gives good recovery. (0-100% heating available both top and bottom).

As it is our policy to improve our machines continuously, we reserve the right to change specifications without prior notice.

2. Overall Dimensions

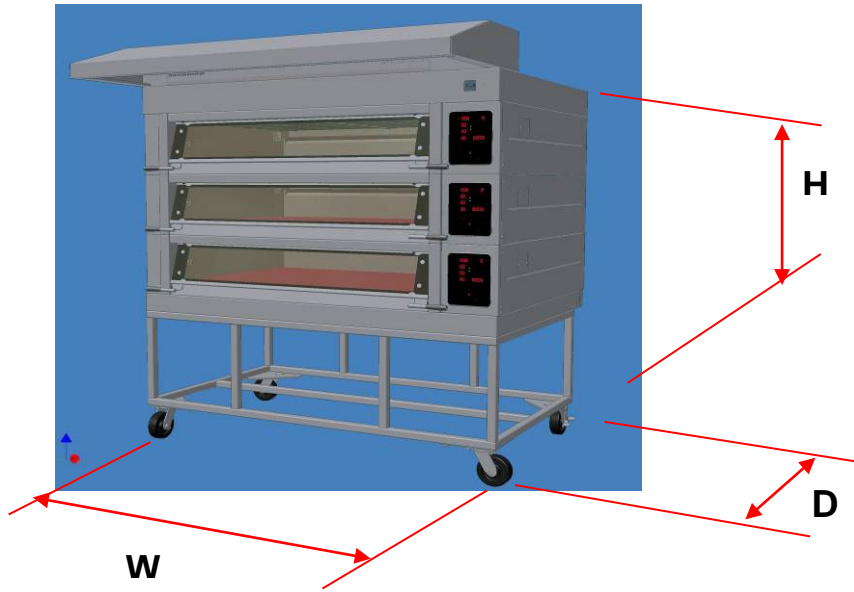

NOTE

■ All dimensions are approximate and do not include the optional canopy (see pages 22 and 23).

Overall dimensions (standard-size decks)

Specification	1-tray wide	2-trays wide	3-trays wide	4-trays wide
Width	955 mm (37½ in.)	1416 mm (55¼ in.)	1890 mm (74½ in.)	2365 mm (93 in.)
Depth	1312 mm (51½ in.)			
Height (2 decks) ⁽¹⁾	2020 mm (79½ in.)			
Height (3 decks) ⁽¹⁾	2020 mm (79½ in.)			
Height (4 decks) ⁽¹⁾	2020 mm (79½ in.)			
Height (5 decks) ⁽¹⁾	2140 mm (84¼ in.)			

⁽¹⁾ Including the base and top finishing. See pages 13 and 14 for dimensional diagrams.

Overall dimensions (compact decks)

Specification	2-trays wide
Width	1354 mm (53.3 in.)
Depth	1172 mm (46.1 in.)
Height (2 decks) ⁽¹⁾	1679 mm (66.1 in.)
Height (3 decks) ⁽²⁾	To be advised
Height (4 decks) ⁽²⁾	To be advised
Height (5 decks) ⁽²⁾	To be advised

⁽¹⁾ Including the base and top finishing. See pages 12 and 13 for dimensional diagrams.

⁽²⁾ Contact MONO Equipment for information.

3. Specifications

Electrical specifications



WARNING ■ An electrical socket must be protected by a 30mA Type 'A' Residual Current Device (RCD) before installation and commissioning of the oven.

The electrical loadings in [Table 1](#) and [Table 2](#) are for an individual deck module, not the complete oven.

Table 1: Electrical loading per standard-sized modular deck

Supply	4-tray wide	3-tray wide	2-tray wide	1-tray wide
400 Vac (50 Hz), 3-phase + neutral + earth	12 kW, 17 Amps	9 kW, 14 Amps	6 kW, 9 Amps	3 kW, 5 Amps

Table 2: Electrical loading per compact modular deck

Supply	2-tray wide
400 Vac (50 Hz), 3-phase + neutral + earth	4.8 kW, 7.5 Amps

Environmental specifications

The noise level is less than 80 dB.

Mechanical specifications

Table 3: Weights for standard-size deck oven

Specification	Nominal trays wide	Modular decks	Weight ⁽¹⁾	
			Lbs	Kg
Total oven weight (including base frame)	4	3	(1)	(1)
	3	3	2345	1064
	2	3	1569	711
	1	3	(1)	(1)
Weight per oven chamber module	4	-	(1)	(1)
	3	-	575	261
	2	-	421	191.5
	1	-	(1)	(1)
Weight per oven canopy module	4	-	(1)	(1)
	3	-	38	17
	2	-	31	14
	1	-	(1)	(1)
Weight per fan module	4	-	(1)	(1)
	3	-	62	28
	2	-	62	28
	1	-	(1)	(1)
Weight of product (maximum) per deck	4	-	(1)	(1)
	3	-	131	60
	2	-	86	39
	1	-	(1)	(1)

(1) To be advised. Contact MONO Equipment for information.

(2) All weights are approximate.

Standard-size deck oven dimensions

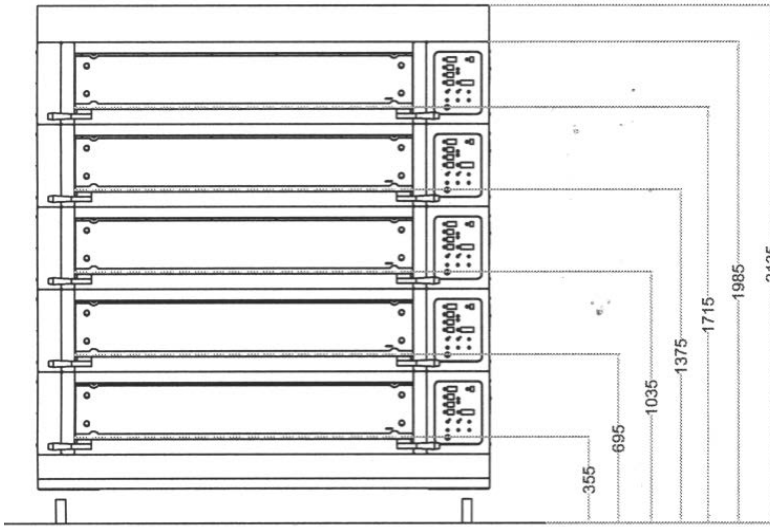

**5 DECK OVEN
DECK PLATE HEIGHTS**

**4 DECK OVEN
DECK PLATE HEIGHTS**

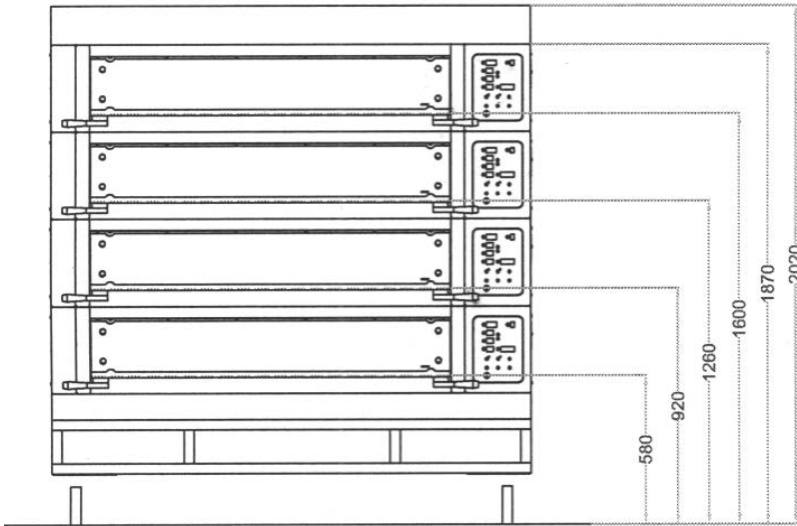

**3 DECK OVEN
DECK PLATE HEIGHTS**

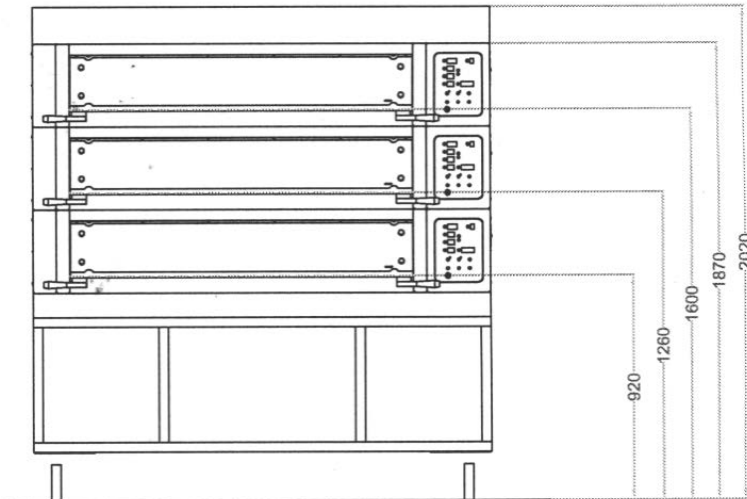

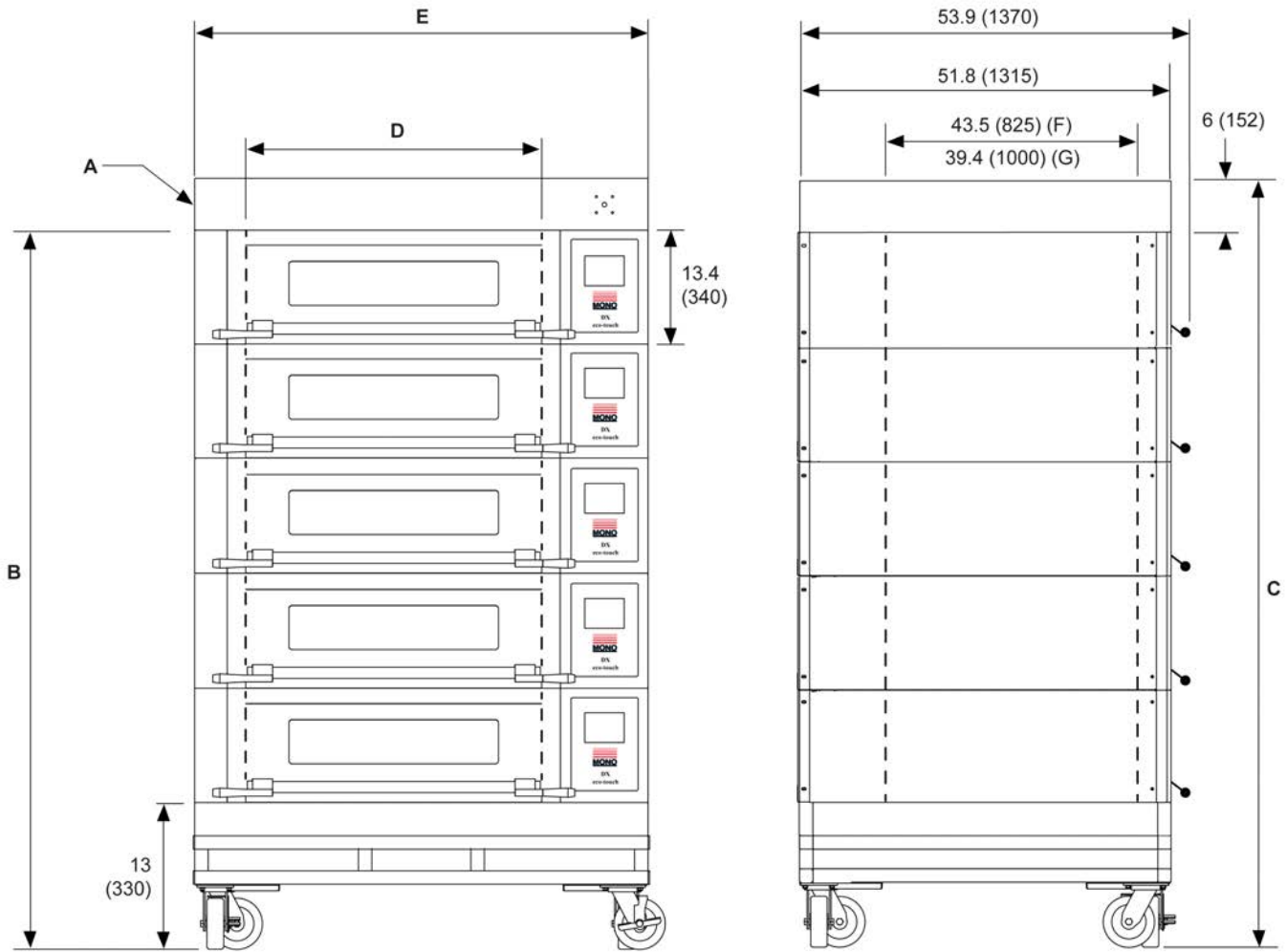

- A. Top valence or extractor hood (to customer specifications)
- B. 5-deck: 78.2 in. (1985 mm); 4-deck and 3-deck: 73.6 (1870 mm)
- C. 5-deck: 78.2 in. (2135 mm); 4-deck and 3-deck: 73.6 (2020 mm)
- D. Baking chamber width – see [Table 5](#) on page 14
- E. Overall deck width – See [Table 6](#) on page 14
- F. Baking tiles – See [Table 7](#) on page 14
- G. Chamber

Table 4: Internal usable surface areas and number of trays per deck

Nominal trays wide	Internal usable surface area (per deck)		Number of trays (per deck)			
	ft ²	m ²	60 cm x 80 cm (24 in. x 32 in.)	60 cm x 40 cm (24 in. x 16 in.)	18 in. x 30 in.	18 in. x 26 in.
4	16.7 ft ²	1.55 m ²	3	4	4	4
3	12.5 ft ²	1.16 m ²	2	3	3	3
2	8.28 ft ²	0.77 m ²	1	2	2	2
1	4.2 ft ²	0.39 m ²	–	1	1	1

Table 5: Baking chamber widths

Number of trays	Chamber width	
	mm	inches
1	483	19
2	950	37
3	1420	56
4	1895	74½

Table 6: Overall deck widths

Number of trays	Deck width	
	mm	inches
1	955	37½
2	1416	55¾
3	1890	74½
4	2365	93

Table 7: Baking tiles

Number of trays	Number of baking tiles (pieces)
1	1
2	1
3	1
4	2 ⁽¹⁾

⁽¹⁾ Two tiles with a gap in the middle.

**NOTE**

■ See pages 22 and 23 for canopy dimensions.

Compact deck oven dimensions

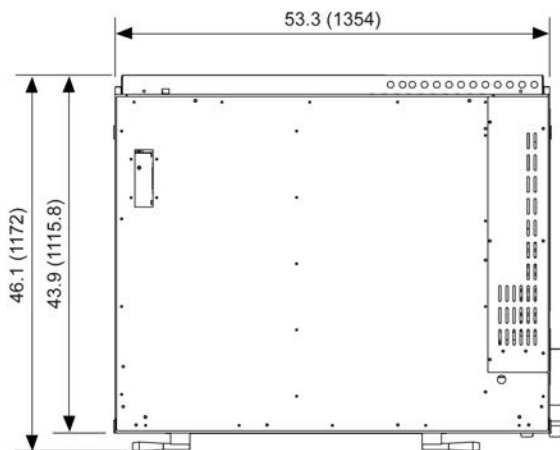
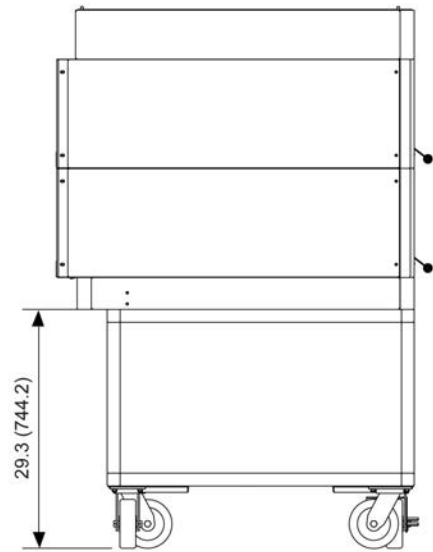
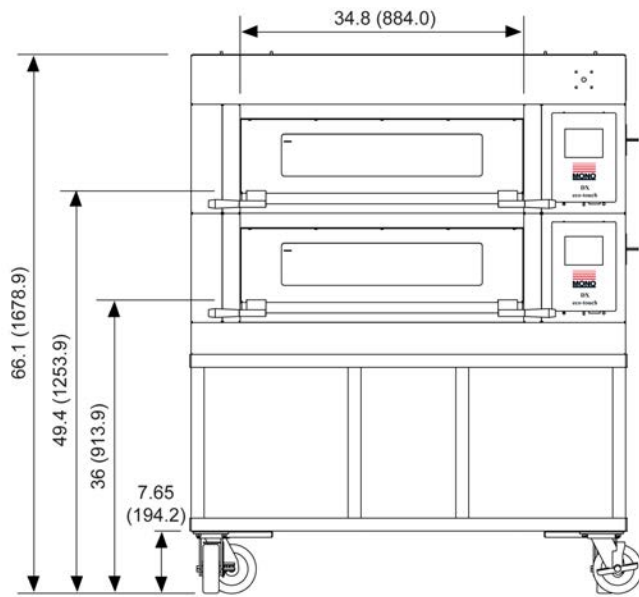

**2 DECK OVEN ON BASE
DIMENSIONS**

Dimensions are in inches (mm)

4. Safety

General safety messages

**CAUTION****■ Magnets information:**

- Magnetic fields in magnets, used in devices and machinery, can inhibit pulse generators for Implantable Cardioverter Defibrillators (ICDs) and pacemakers. Magnets can activate a switch prohibiting the ICD from delivering vital signals such as lifesaving shocks.
 - If you have an ICD or pacemaker, avoiding close or prolonged contact with magnets or their magnetic fields is advisable. Keep magnets at least six inches from where your device is implanted. **If you feel any interference in any way, immediately move away from the source.**
-

Oven safety messages

Only fully trained and authorised persons are permitted to work on the oven. Qualified electricians must carry out all repairs and maintenance. Always disconnect or isolate the power supply before starting maintenance or cleaning work on the oven.

A responsible Bakery Manager or Supervisor must carry out daily safety checks. Bakery staff **must not**, under any circumstances, remove covers or panels to access any part of the oven.

**DANGER**

- Never use the USB port to power or recharge electronic devices, e.g. mobile phones. Incorrect usage causes damage to the oven and could result in a fire.
-

**WARNING****■ Before using the oven:**

- Ensure all covers, panels, cables, and pipe fittings are secure.
 - Visually examine the oven for apparent damage or signs of tampering.
 - If the oven is damaged or malfunctioning, or missing parts:
 - Stop using it.
 - Do not attempt any repairs.
 - Contact MONO Equipment for technical assistance.
 - Never operate the oven with any covers or panels removed.
 - All utility connections to the oven must comply with the statutory requirements of the country where the oven is installed.
 - Ensure this product manual is read thoroughly before operating the oven. Operate and maintain the oven only as described in this product manual.
-

**WARNING**

- An electrical socket must be protected by a 30mA-rated Type 'A' Residual Current Device (RCD) before installation and commissioning of the oven.
 - Always fit a wall-mountable isolator switch to isolate the oven entirely from the electrical supply in an emergency. The isolator must be visible, labelled as an emergency shutdown device, and easily accessible.
 - Check that the electrical requirements on the oven's information plate match the supply before connecting the power cable and turning the power on for the first time.
 - Before installation, it is recommended that a qualified and competent electrician first tests the electrical outlet for electrical safety.
 - Always ensure your hands are dry before touching any electrical components, including cables, switches, and plugs.
-

**CAUTION**

- Be aware of hot surfaces:
 - Do not touch the oven door with bare skin.
 - Always use oven gloves when loading or unloading the oven.
 - Allow time for the oven to cool down before cleaning it.
 - While the oven is in operation (and for some time after use), touching the oven door or the surrounding panels is inadvisable because of conducted heat.
 - When removing products from the oven, ensure the following:
 - Tins are knocked out and stored directly onto a tin storage trolley or rack. Do not leave hot tins on the floor or tables.
 - Trays are put into a rack and then wheeled to a safe cooling area.
 - Fully train operatives before they use the oven. Anyone undergoing training must be under the direct supervision of someone experienced.
 - Ensure there are no trip hazards around the oven, e.g. trailing cables.
 - Check that the floor around the oven is not slippery, e.g. no liquid spills.
 - Do not store items on top of or behind the oven.
 - Never climb onto the roof of the oven.
 - Only use the oven for baking bread, pastries, and cakes. Contact MONO Equipment for other product-baking machines.
 - No unauthorised modifications to the oven are permitted.
-

Emergency instructions

To stop the oven in an emergency, switch it off using the main isolator on the oven.

A wall-mounted isolator, rated for the specific model of oven installed, must be available to isolate the oven in an emergency completely. The isolator must be accessible and known to the oven operator.

Figure 1: Main isolator switch on the oven

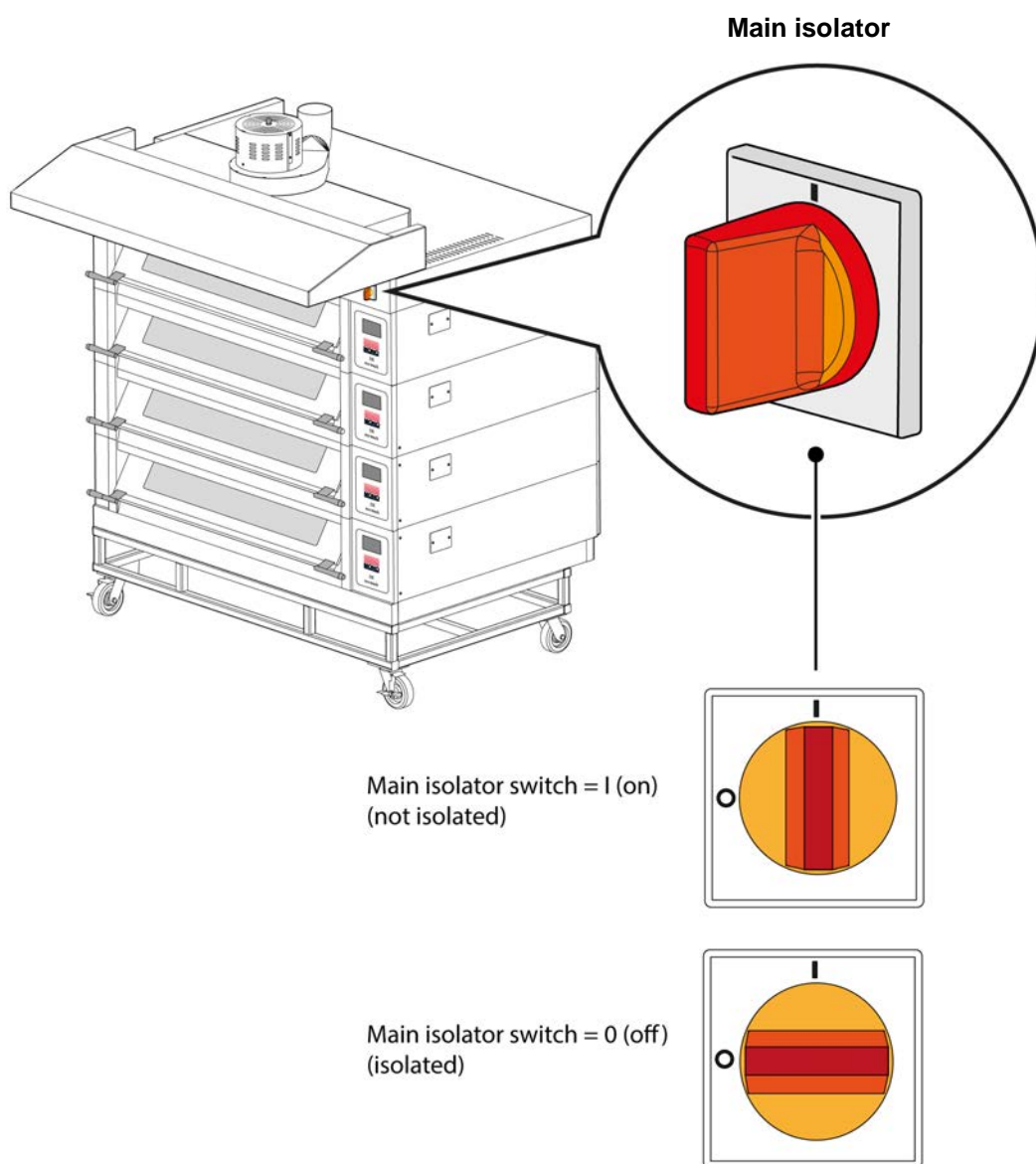

5. Installation

General

- A solid, smooth, level floor is recommended on which to position the oven, and access for maintenance should be considered.
The oven is not a “built-in” design. Sufficient clearance must be left in front of the access panels (right-hand side) for servicing.
- If not chosen as an oven option, an extraction hood should be sited above the oven to disperse excess steam and heat, which could adversely affect the bakery ceiling and ambient temperature.
- A chain retainer, shorter than the power cables, should be fitted to protect them from strain if the oven moves. Fit it to the wall or floor and the base, using the hole in the castor fixing corner plates.
- Only trained engineers are authorised to install this oven. All water and electrical connections must comply with local and national regulations.

Electrical connections

- The main connection point for all deck supplies is at the top of the oven.
- A wall isolator must be available to isolate the oven completely. This isolator must be easily accessible to the oven operator.
- Read the **Safety** section on page 16.
- Electrical loadings are in the **Specifications** section on page 11.

Fit earth straps (part no. 158-25-11200)



NOTE ■ Factory-built ovens already have them fitted, but always check that they are fitted.

Figure 2: Connect earth (ground) straps between each modular deck

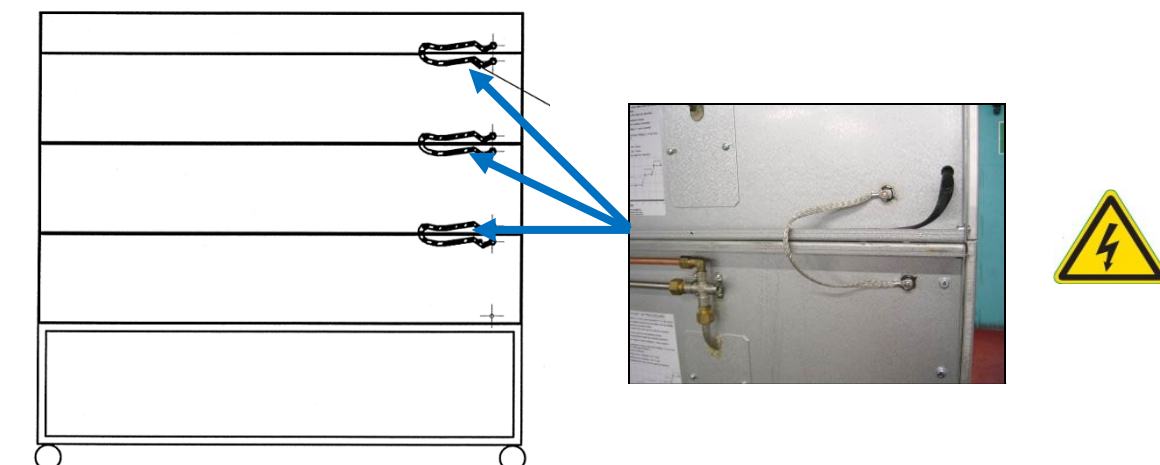

Fit the tile retaining brackets (part no. 257-06-00015)



NOTE

- Only deck ovens built on-site need this procedure, but always check that they are fitted.

Procedure

1. Find the brackets and screws loose in a supplied plastic bag.
2. Position the bracket to touch the tile (as shown in the photograph)
3. Fix the bracket using two screws.
4. Repeat steps 1 to 3 for both sides of each deck.

Figure 3: Installing the tile retaining brackets

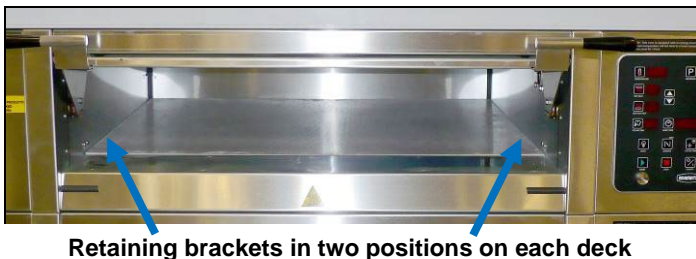

Water supply requirements



NOTE

- The setup procedure on the next page must be followed to allow the steaming system to function correctly.

- All ovens with steam require a $\frac{3}{4}$ " BSP hot or cold water supply at a pressure of 2 to 3 bar (29 to 44 psi).
- Only one water supply is required per oven and must comply with local water regulations.
- All decks are supplied from one connection point on the rear of the oven.
- For proper operation of the steam system, it is recommended that the water supply has the following specifications:

Hardness 0 to 4 grains per gallon

PH range 7.0 to 8.5

Chloride concentration 0 to 20 ppm

Consult Mono for proper water filtration system information.

- No drain is required for this oven.
- A non-return check valve is supplied and fitted to the water inlet manifold.

Water system setup procedure



The water delivery to the deck oven must be checked for the steam system to operate correctly.

Note that dynamic pressure, not static pressure, is being measured.

Procedure

1. Flush out the main feed pipe to be used until water runs clear and free from debris.
2. Connect the main feed to the oven.
3. Connect flexible hoses to each deck.
4. Place a container under the test valve **(B)**.
5. Slowly open test valve **(B)** fully and, with the water flowing, set the regulator **(C)** to 0.75 bar using the screw underneath **(D)**.
 - Never use the oven above this setting.
6. When the pressure has stabilised, shut the test valve **(B)**.
7. Repeat steps 4 to 6 at the end of the installation.

Figure 4: Water regulator setup (located on the rear of the oven)

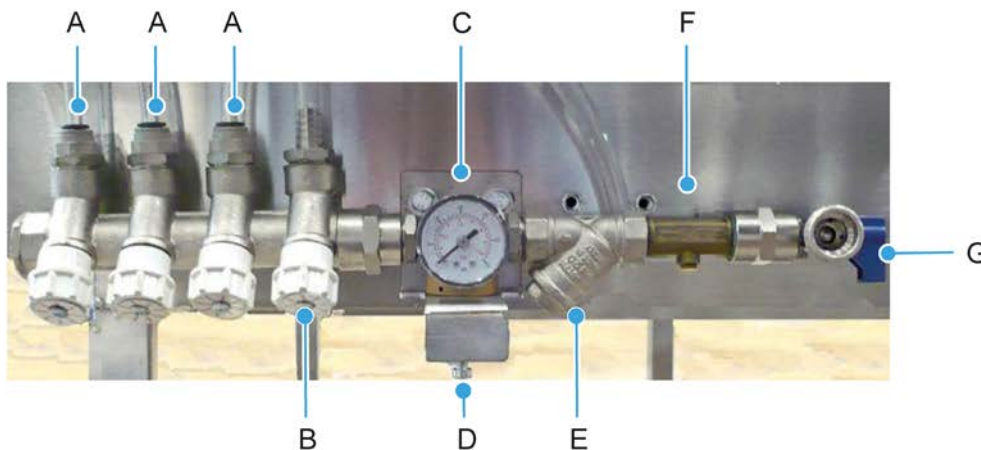

-
- A. To ovens
 - B. Test valve
 - C. Regulator
 - D. Adjusting screw to 0.75 bar
 - E. Filter
 - F. Dual check valve backflow prevention device
 - G. Stop tap
-

Exhaust Connections (if canopy fitted)

- Ideally, an exhaust duct should rise 2 metres above the bakery roof and be protected from wind and birds by a duct protector.
- It should be of a suitable material to take the high temperatures and humidity expected.
- It should be flexible and easily removable at the oven connection point.
This allows the oven to be moved for cleaning when required.

Figure 5: Canopy (without fan) dimensions

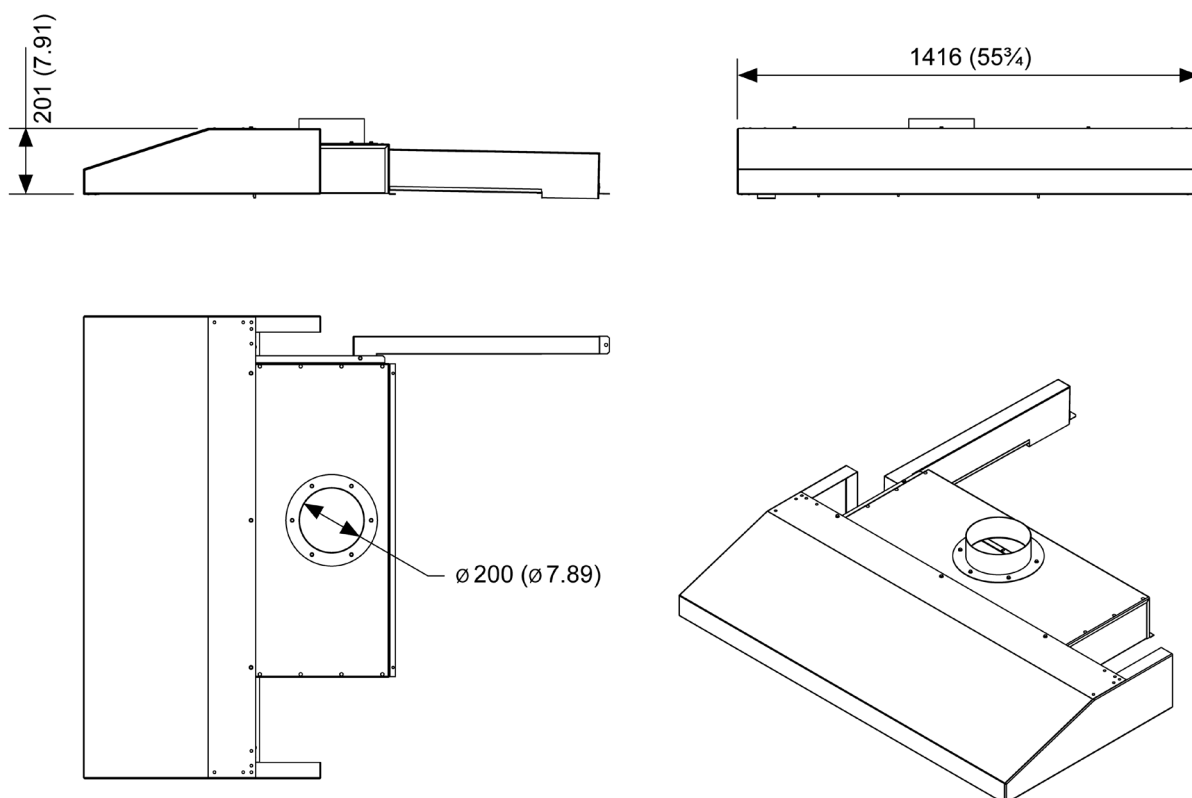

Dimensions are in mm (inches)

Figure 6: Canopy (with fan) dimensions

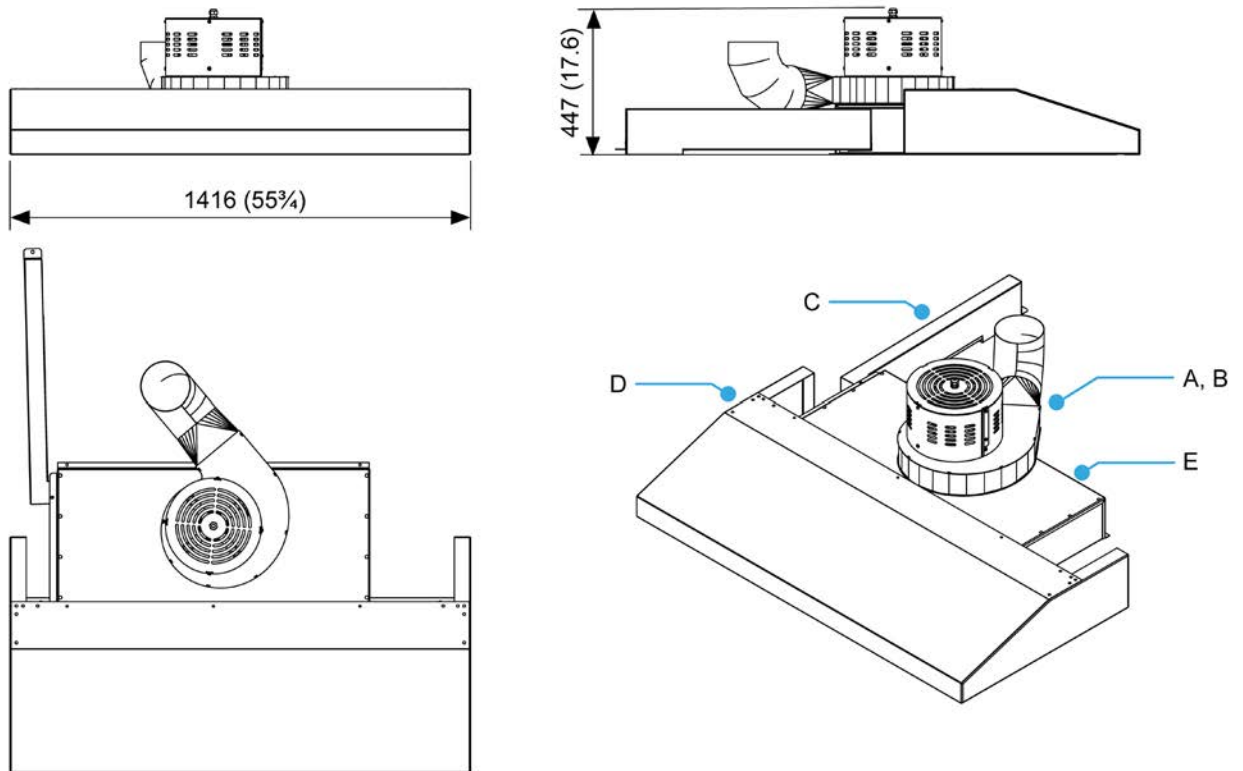

Dimensions are in mm (inches)

Table 8: Canopy parts

Item		Part number
A	Extraction fan assembly	247-08-04900
B	Inlet ring	247-08-05100
C	Flue assembly	257-10-00010
D	Canopy assembly	257-10-00016
E ⁽¹⁾	Extraction duct assembly for 2-tray oven width	257-10-00022

⁽¹⁾ Contact MONO Equipment for the availability of other extraction duct assemblies.

6. Before first use of the deck oven

Operating conditions

- Leave a clear space of at least 2 to 3 metres (6 to 10 ft.) in front of the oven for practical and safety reasons.
- Do not use bakery utensils to operate the control panel buttons.
- Ensure that the locking casters are locked into position.
- For hygiene reasons, MONO Equipment highly recommends thoroughly wiping the inside of the oven and all accessories with a clean cloth soaked in warm soapy water before using the oven for the first time. Although the utmost care is taken during assembly and pre-delivery inspection, there is always a possibility of residue contaminating the first bake if this is not done.

Baking tile ‘seasoning’ instructions

THIS PROCEDURE MUST BE FOLLOWED FOR THE OVEN’S WARRANTY TO REMAIN VALID.

For the oven to give good, reliable service, the deck tiles must initially be brought up to temperature as stated below; this ensures all residual moisture in the tiles has been removed.

This procedure must be actioned **once** before the deck oven is used for the first time. After the tile seasoning procedure has been run, the oven can be used as required.

Tile seasoning procedure

1. From the Main Menu, select the **Settings** icon.



2. Enter the default password **123456** (unless changed) and touch **OK**.



3. Select the **High Level Settings** option.



4. Enter the default password **561234** (unless changed) and touch **OK**.
5. Select the **Tile Seasoning** option to start running the seasoning program automatically.

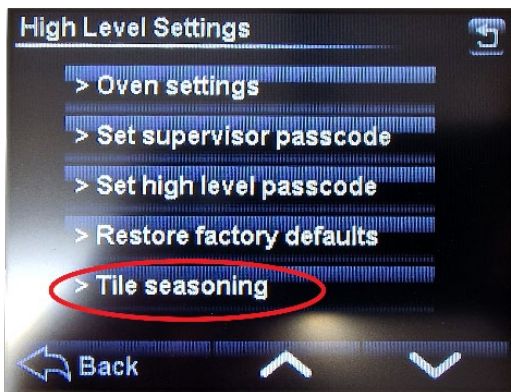

6. The oven's controller shows the **Target Temperature** and the **Remaining Process Time**.



The oven now follows the **Tile Seasoning Temperature** rise over the time shown on the screen, with the damper opening and closing periodically during the process.

7. Wait until the oven returns to the standard wallpaper **Standby** screen at the end of the program.
8. The tile seasoning is complete, and the deck oven can be used for baking.



NOTE

- To stop the tile seasoning procedure, cycle the deck oven off and then on using the main isolator switch.
- The deck oven reverts to standby mode when power is restored.

Baking principles



NOTE

- Operators should refer to their company's recipe manual for the oven temperature settings.

Baking heat

Products bake in an insulated, heated chamber with the temperature regulated by a thermocouple. A digital temperature read-out is visible on the control panel screen. Baking heat is radiant, with top and bottom heat adjustable by separate controls. This technology enables heat to be “balanced” according to product requirements.

Steaming function

Steam is provided from an integral steam unit and injected into the chamber on demand. Programmed parameters automatically control this function.

After being steamed, the oven does not allow more steaming until the steam unit has recovered heat, typically for 3 to 10 minutes, depending on the selected program.

All deck ovens have a steam damper that evacuates steam humidity into a vent at the rear of the oven.

Baking advice

Advice for getting the best results from deck ovens:

1. **Do not place the products too close together.** *If the loaves are close to each other after the oven spring (expansion), it results in soft sides and may collapse on cooling.*
2. **Place the product evenly within the oven.** *Products bunched together are paler than those widely spaced.*
3. **Products should not be too close to the edge of the tile.** *As it expands towards the front, one side of the loaf may enter the cooler air by the door.*
4. **The door opening should be kept to a minimum** *because cold air enters the oven. Cooling of the sidewalls and roof causes the finished product to be lighter locally at the front and wastes heat. If loading times are consistently long, alter the front-top heat to put more heat at the front.*
5. **The product can form a skin if the loading takes a long time,** *which causes an imbalance and a less attractive finish. By using the pre-steam function before loading, this can be minimised. The steam function turns the elements off and injects steam to increase the humidity.*

Bake settings

1. A good starting point for baking bread in Mono deck ovens is **225 °C (437 °F)**.

Top heat: 60 to 65	Bottom heat: 40
---------------------------	------------------------
2. For cookies (and similar products), the oven's heat can be turned almost off. However, it may still be necessary to place the trays with, e.g. cookies, onto upturned trays on the oven sole.
3. **Steam** should be kept to a minimum for energy efficiency, depending on the product and finish. **Times of between 9 and 12 seconds should be adequate.** It is a good idea not to focus on the temperature recovery – this can vary from oven to oven.

Is the product baked in the time and to the quality you require?

Below are some tips for modifying the bake to get the product that you require.

- If your product is **light on top**, decrease the bottom heat and extend bake time or increase the top heat.
- If the product **sides are pale** and the **top dark**, space the products well apart, drop the top heat, and extend the bake time.
- **If the bake time is too long**, first increase the top heat to speed recovery. If this does not give sufficient savings, increase the baking temperature.
- **To thicken the crust**, set the Damper to be open for longer. Different ovens require different lengths of time.

7. Operating Instructions

Each deck has an independent, colour touchscreen for operating the oven.

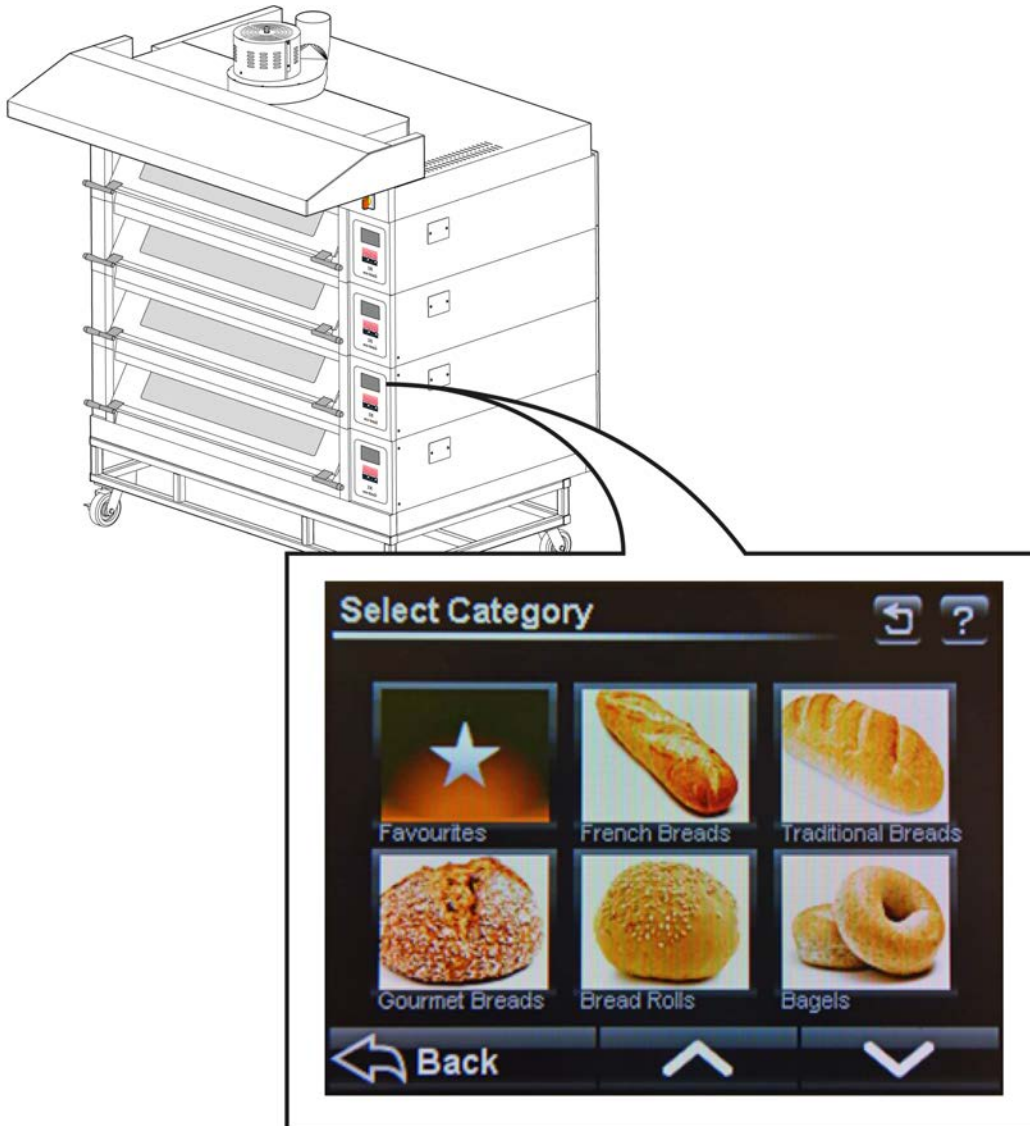

Basic operation

Operations are performed by touching an area of the screen, bringing up the next information panel or activating a function.



Do not use excessive force.
The pressure required to operate the panel is adjustable in the **Settings**.

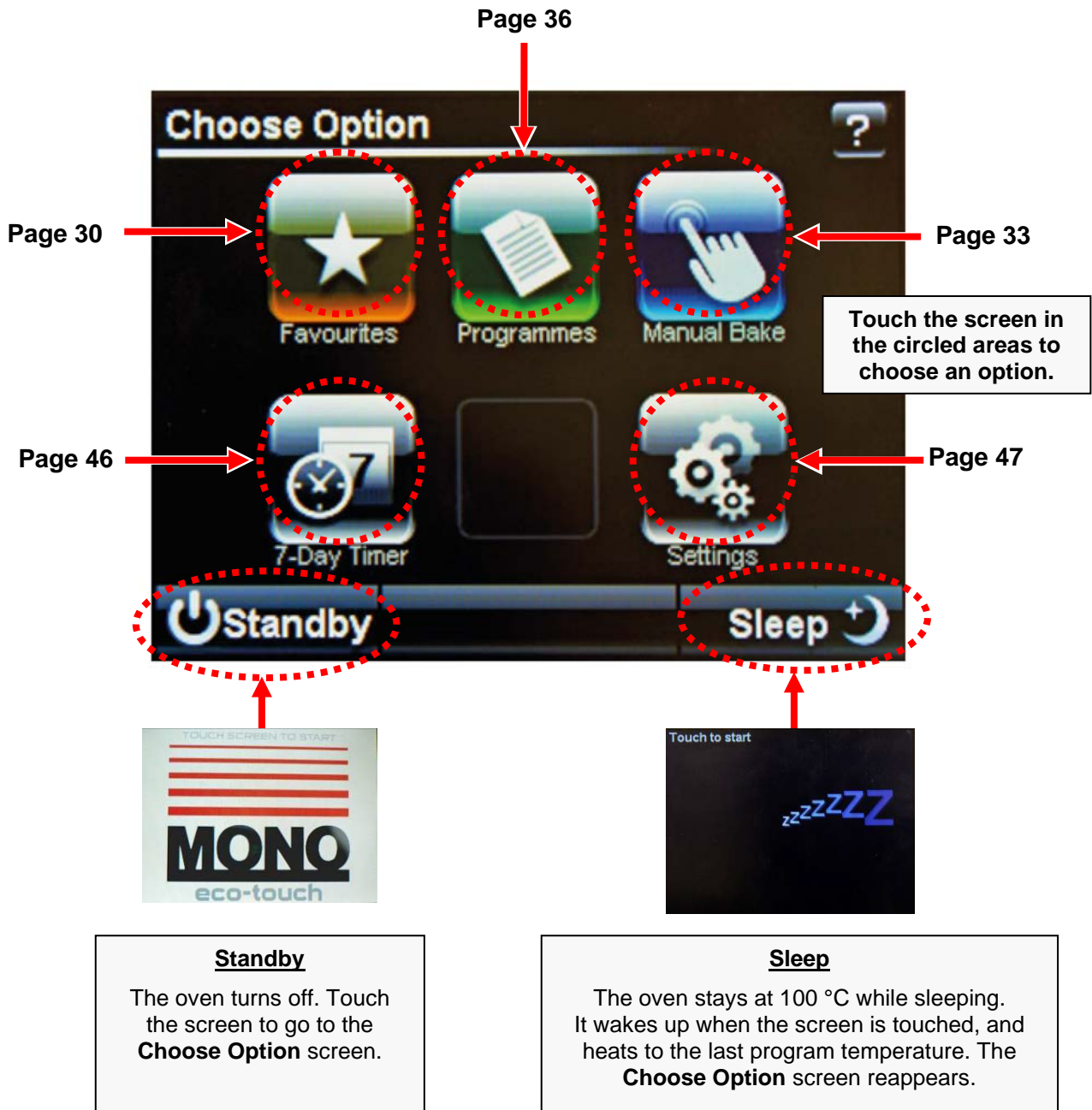

Baking using the “Favourites” menu

Touch to open the **Favourites** selection screen

1



OPTION SCREEN

Touch the name of the product required

2



Up to 5 products are listed on a page. Touch the **UP-ARROW** or **DOWN-ARROW** to see other pages of products.

SELECTION SCREEN

Touch **Full Load** or **Half Load** to select a quantity
(This screen only appears if a half load is saved in the program)

3

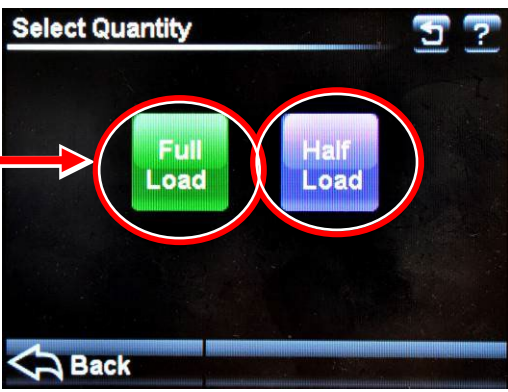

Touch the **Back** button to return to a previous screen.

LOAD SCREEN

4

Wait for the oven to reach the required temperature (200 °C in this example)
 (The **Heating** message remains on the screen while the oven is heating up)

If the oven is too hot for the temperature chosen, the screen tells you to open the door for cooling. **Take care to avoid burns.**

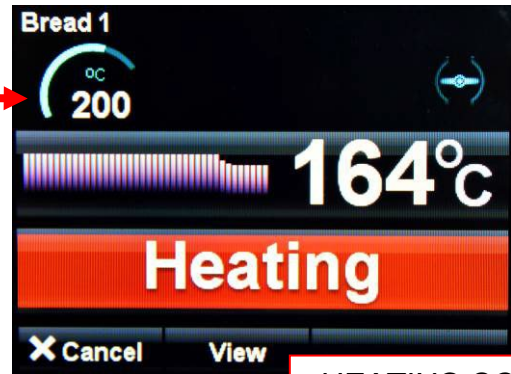

HEATING SCREEN

5

When the oven is at the correct temperature, the message changes to **Ready**. Now:

- 5.1. Open the door and carefully load the oven with the prepared trays of product.
- 5.2. Fully close the door.
- 5.3. Touch the **Start** button.

Tip! To help keep the oven hot, avoid opening the door more than needed.

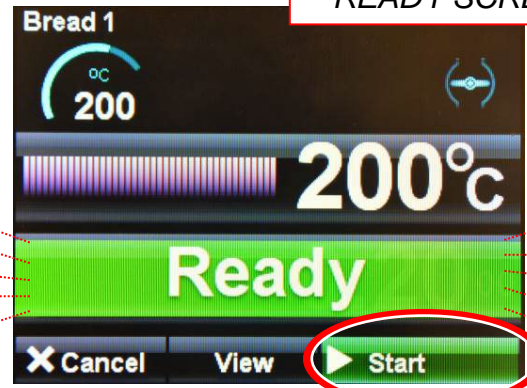

READY SCREEN

6

The **Bake In Progress** screen shows the baking time remaining

Actual oven temperature
 (This will rise and fall near to the required temperature)

Required temperature →

Temperature profile bar →

Bake time progress bar →



Baking time remaining

Note: The actual temperature shown will rise and fall above and below the required temperature as the oven cools and reheats. **This is not a fault.**

At the end of the bake time, a sounder will be heard and **Bake Over** will flash. Now:

- 7.1. Touch the **Stop** button.
- 7.2. Open the door.
- 7.3. Carefully remove the trays of product.

7

Note! To keep the oven baking for extra minutes, touch the **+ 2 mins** button. This time can be adjusted in the set up.



Touching the View button during a bake (optional)

Touch the **View** button during a bake to show the settings for that particular bake.

Touch the **Cancel** button to go back to the previous screen. (It does not cancel the bake).



VIEW SCREEN



Baking using the “Manual Bake” menu

1
Touch to open the **Manual Bake** screen



OPTION SCREEN

2
Set the top and bottom heat
2.1. Touch a % button on the screen to activate the keyboard screen.
2.2. Key in the required percentage of heat.
2.3. Touch **OK**.



MANUAL BAKE SCREEN

3
Set the bake temperature
3.1. Touch the temperature to activate the keyboard screen.
3.2. Key in the required temperature.
3.4. Touch **OK**.



4
Set the bake time (optional)
4.1. Touch the time to activate the keyboard screen.
4.2. Key in the required time.
4.3. Touch **OK**.



Note: The bake time does not have to be set in manual mode. When **Start** is pressed, the timer increases instead of counting down. Touch **Stop** to finish the bake.

Set the Steam Time and Damper (if required)

(Manual Bake)

Steam

Touch and hold for the time (seconds) steam is required.

(This can be used before or during the bake)

5

Damper

Touch to set the Damper to open during the bake. (Icon changes colour to green)

Touch again to close the Damper. (Icon changes colour to red)

6



MANUAL BAKE SCREEN 2



Cancel

Touch at any time to return to the **Options** screen.

Touch **Start** to begin the bake.

7



Touch **Stop** when the end-of-bake buzzer sounds or when required time was entered.

8

Save (keep) the Manual Bake Program

(Manual Bake)



MANUAL BAKE SCREEN 3

Save settings 9

Touch **Save** to show an option screen.

(If no time was entered at the start of the bake, when **Stop** is touched at the start of the bake **Save** appears at the bottom of the screen)

10 Touch **Add to favourites** or **Save As...**

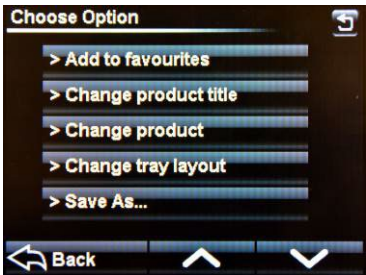

11 Use the keyboard to type the required name and touch **Save**.



Note: In manual mode, only one operation of the steam or damper is saved.

Baking using the "Programmes" menu

Note: This manual covers two versions of the firmware. (The oven is pre-set to show one only).

- **PICTORIAL** version shows choices of product categories
- **NUMERICAL** version shows ranges of program numbers

Touch to open the **Select Category** or **Program Choice** screen. **1**



Touch the type of product or program-range. **2**

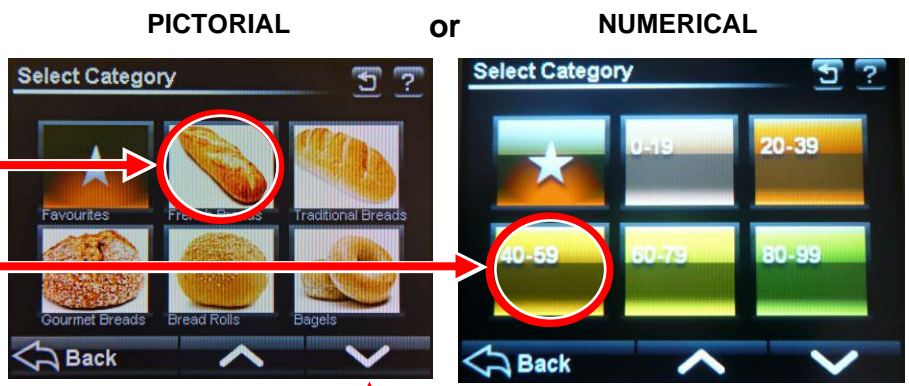

More choice screens

Touch the name or number of the product. **3**



Touch **Full Load** or **Half Load** to select a quantity (This screen only appears if a half load is saved in the program). **4**

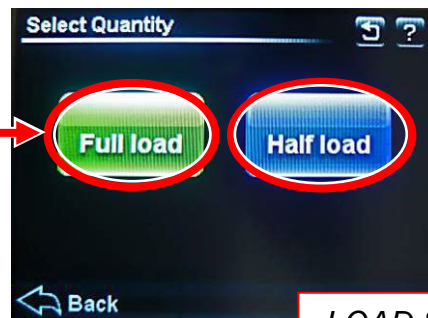

Touch the **Back** button to return to a previous screen.

LOAD SCREEN

5

Wait for the oven to reach the required temperature (200 °C in this example).
 (The **Heating** message remains on the screen while the oven is heating up).

If the oven is too hot for the temperature chosen, the screen tells you to open the door for cooling.
Take care to avoid burns.

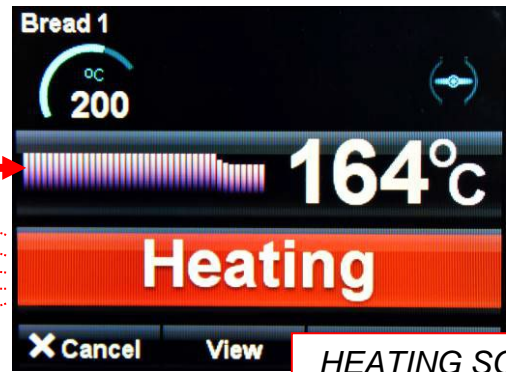

HEATING SCREEN

READY SCREEN

6

When the oven is at the correct temperature, the message changes to **Ready**. Now:

- 6.1. Open the door and carefully load the oven with the prepared trays of product.
- 6.2. Fully close the door.
- 6.3. Touch the **Start** button.

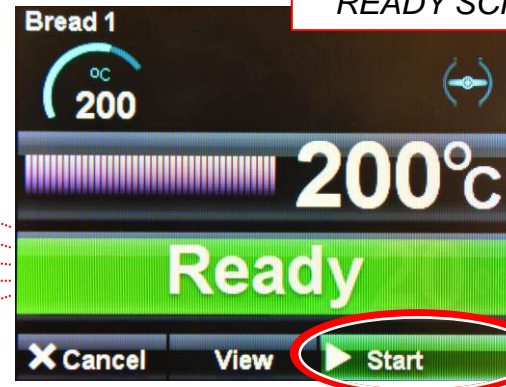

Actual oven temperature
 (This will rise and fall near to the required temperature)

7

The **Bake In Progress** screen shows the baking time remaining.

Required temperature →

Temperature profile bar →

Bake time progress bar →



Baking time remaining

Note: The actual temperature shown will rise and fall above and below the required temperature as the oven cools and reheats.
This is not a fault.

BAKE OVER SCREEN

8

At the end of the bake time, a sounder will be heard and **Bake Over** will flash. Now:

8.1. Touch the **Stop** button.

8.2. Open the door.

8.3. Carefully remove the trays of product.

Note: To keep the oven baking for extra minutes, touch the **+ 2 mins** button. This time can be adjusted in the set up.

Touching the View button during a bake (optional)

Touch the **View** button during a bake to show the settings for that particular bake.

Touch the **Cancel** button to go back to the previous screen. (It does not cancel the bake).

VIEW SCREEN

Creating a bake program

Touch **Programmes** to open the **Select Category** screen.

1

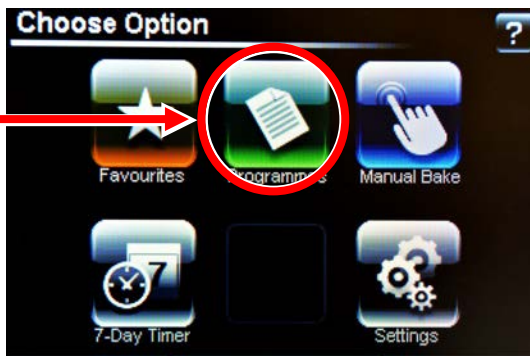

OPTION SCREEN

Touch the type of product wanted.

2



CATEGORY SCREEN

Touch the "?" button next to the blank program to open the **Product Information** screen.

3



SELECT SCREEN

Enter the Supervisor passcode

(Creating a Bake Program)

INFORMATION SCREEN



Touch **Option** to open the Pass Code screen. **4**

PASS CODE SCREEN

Enter the Supervisor pass code and then touch **OK**. **5**

Note: Default code = 123456. This can be changed in the Settings menu).



Enter the product bake details

(Creating a Bake Program)

OPTION SCREEN

Touch **Change product**. **6**

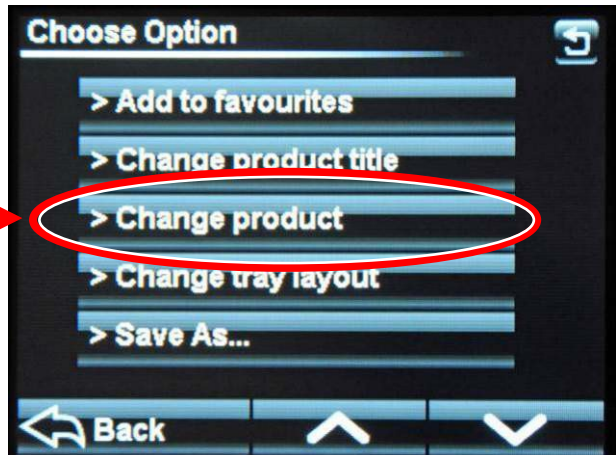

Load type

VALUE CHANGE SCREEN

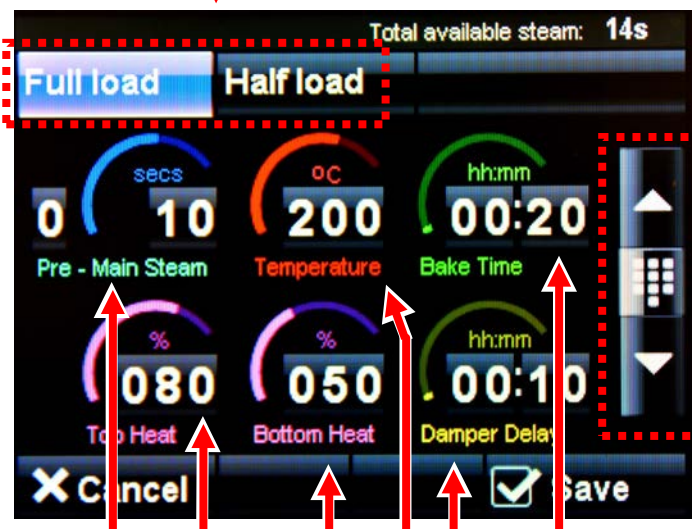

Enter amount required and touch Done



Increase

Or use keypad

Decrease

Touch an item and then change the value by using the **UP-ARROW** and **DOWN-ARROW** keys, or the **keypad**.

7

Touch **Half load** to changeover to the half-load settings, if required. To change back to the full-load settings, touch **Full load**.

Touch **Save** when satisfied with the settings.

Changing the tray layout

(Creating a Bake Program)

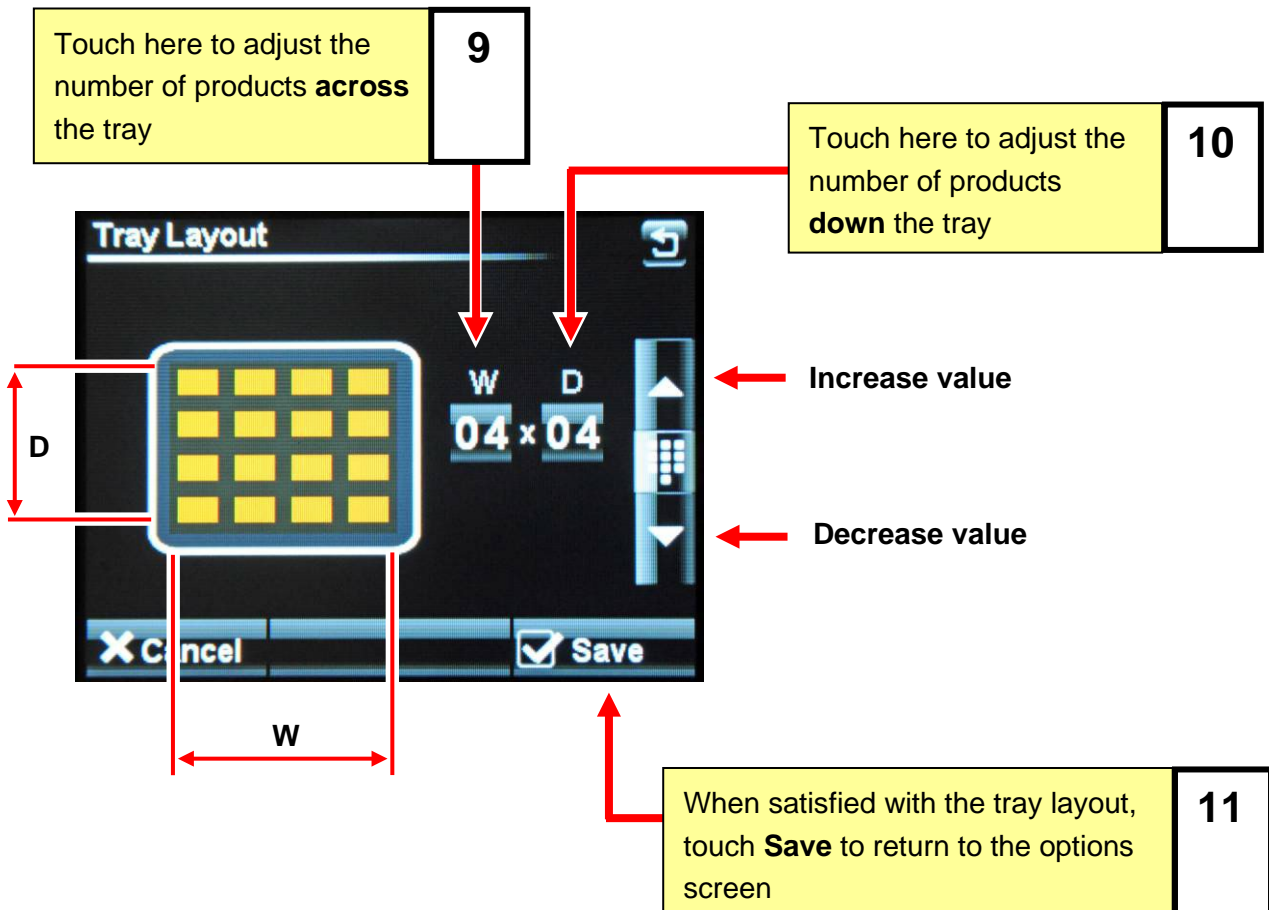
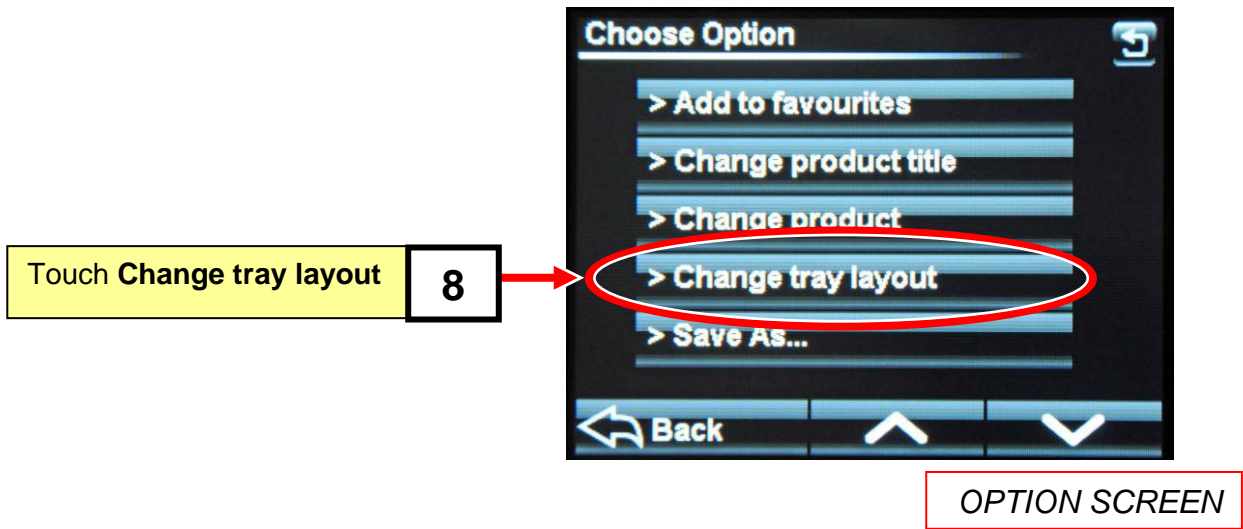

Save the product

(Creating a Bake Program)

OPTION SCREEN

Touch **Save As...** **12**

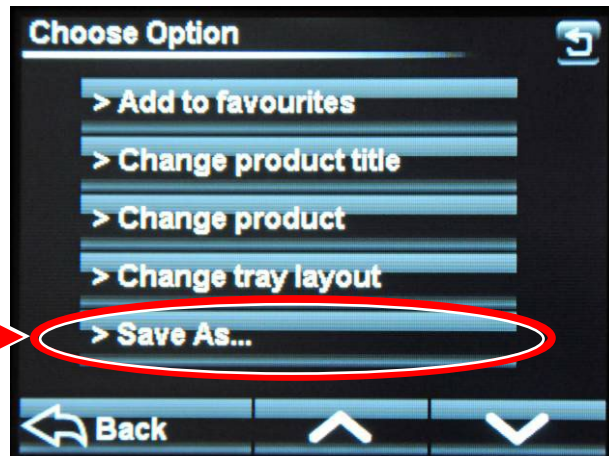

KEYBOARD SCREEN

Type in the new name and touch **Save**. **13**

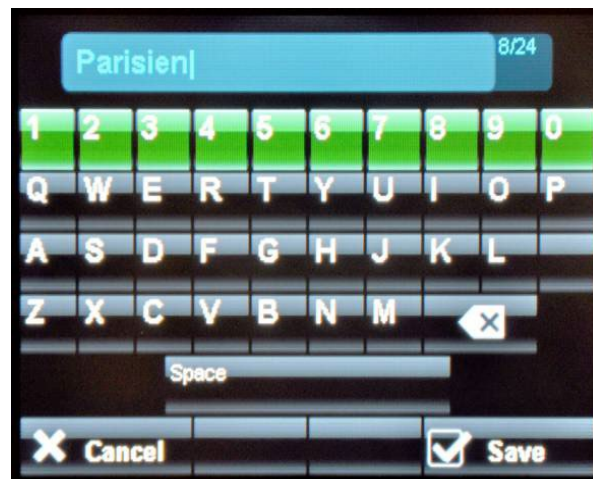

Add a product to the favourites list (optional)

Touch the type of product wanted to open the **Select Product** screen.

1



CATEGORY SCREEN

Touch the "i" (information) button next to the product you want as a favourite. (This opens the **Choose Option** screen)

2



SELECT SCREEN

Enter the Supervisor pass code and then touch **OK**.

3

Note: Default code = 123456. This can be changed in the Settings menu).



PASS CODE SCREEN

Touch **Add to favourites**.
(The product now appears on the favourites list).

4

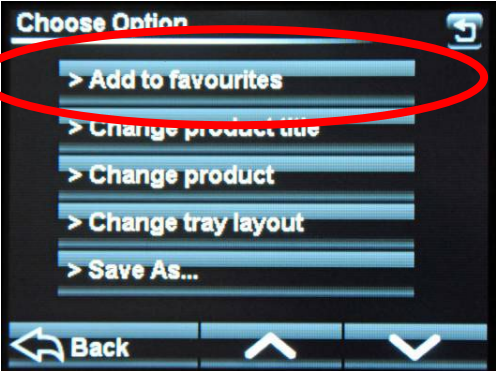

OPTION SCREEN

7-day timer

Touch **7-Day Timer** to open the setup screen.

1



OPTION SCREEN

Touch a day. (Sunday is highlighted in this example).

2

Set the **On** times. Touch the hours, and then use the arrow buttons. Repeat for the minutes.

3

Set the **Off** times. Touch the hours, and then use the arrow buttons. Repeat for the minutes.

4

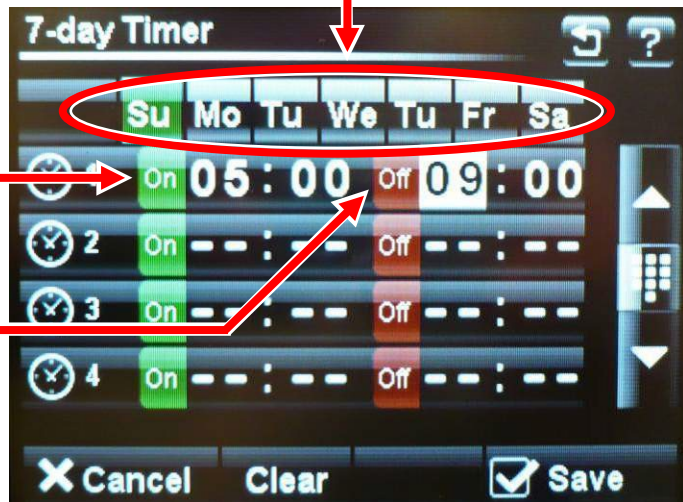

TIMER SETUP SCREEN

Increase the time

Decrease the time

Repeat steps 2 to 4 for each required day. Touch **Save** to activate the 7-day timer.

5

Note:
 Up to four on/off times can be set for each day.
 Touch "clear" to clear the settings on the day shown.

Settings

OPTION SCREEN

Touch **Settings** to open the settings menu screen.

1



Enter the Supervisor pass code and then touch **OK**.

2

PASS CODE SCREEN

Note: Default code = 123456.
 This can be changed in the Settings menu).



Choose the settings to alter.

3

SETTINGS SCREEN

- Time & date..... page 48
- Start screen wallpaper..... page 48
- General settings page 49
- High level settings page 51
- Diagnostics..... page 57

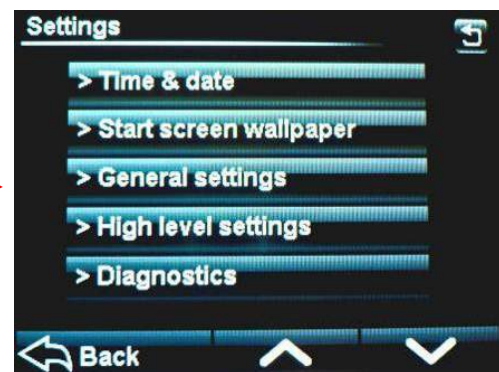

Set time and date

(Settings)

1
Touch the screen to highlight the item to be changed (e.g. "12" hours).

TIME AND DATE SCREEN

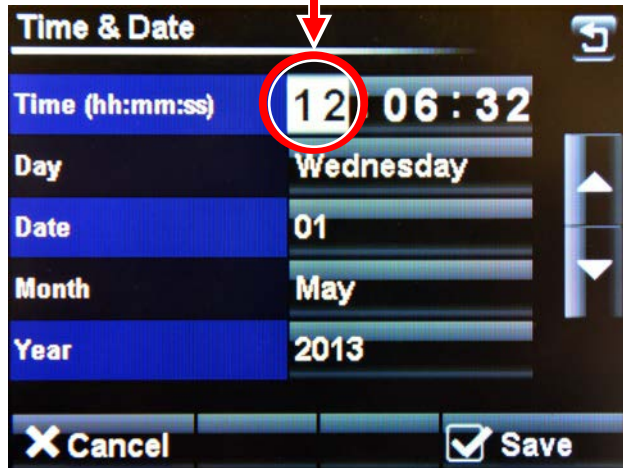

2
Use the **UP-ARROW** and **DOWN-ARROW** buttons to change the value of the item.

3
Touch **Save** when the date and time are correct. The Settings menu will then open again.

Select a wallpaper for the start screen

(Settings)

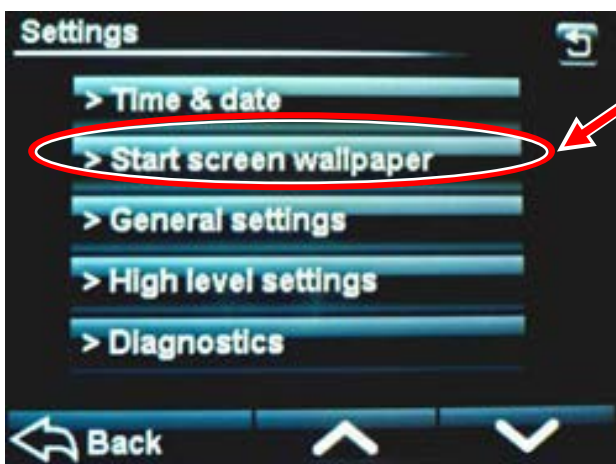

1
Touch **Start screen wallpaper**.

2
Touch a wallpaper to select it. Touch **Back** to confirm.

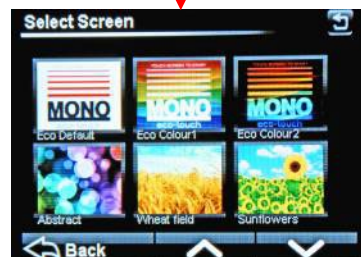

Use the arrow keys to see more wallpapers.

General oven settings

(Settings)

See **Table 9** for a guide to each oven setting.

Touch **General settings** to open the **Oven Settings** screen.

1

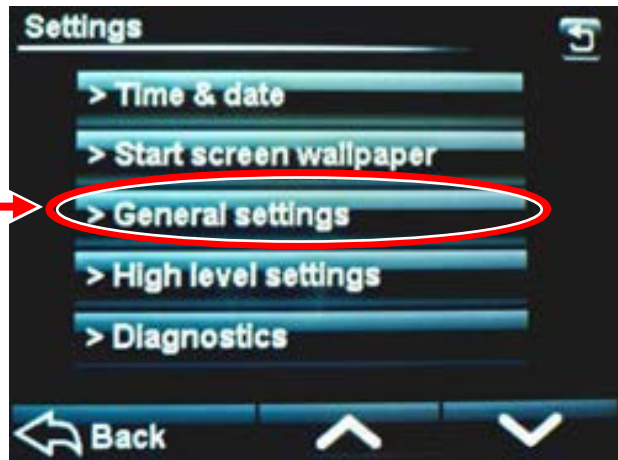

SETTINGS SCREEN

Use the arrow buttons to scroll through all the options. Change each one as required.

2

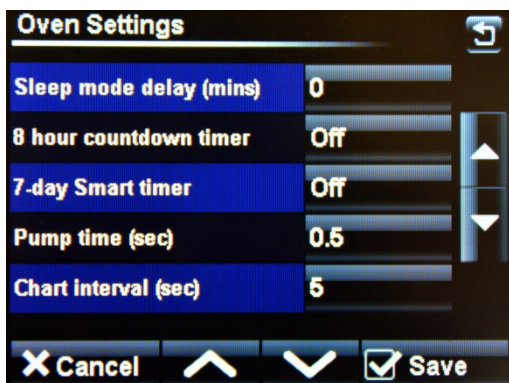
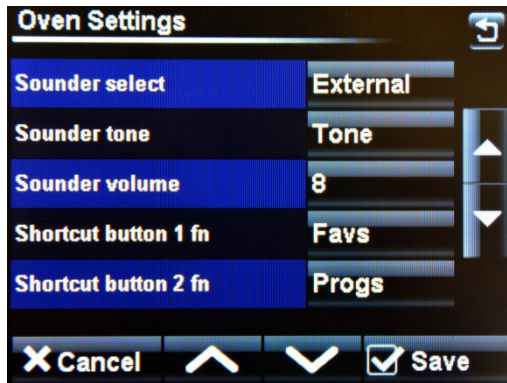
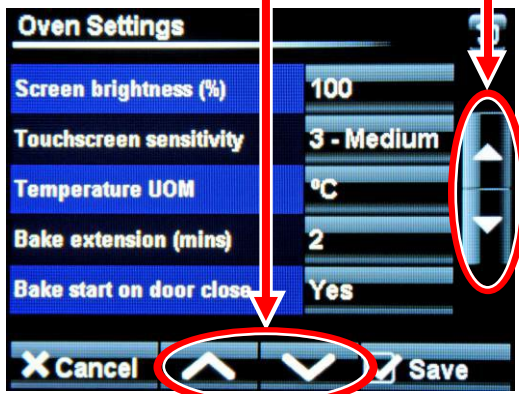

Table 9: Oven settings explained (general level)

Oven setting	Explanation of the settings	Default
Screen brightness	Adjusts the brightness level of the viewing screen. Settings are 5 to 100.	100
Touchscreen sensitivity	Adjusts the pressure required to operate the touch screen. (5 levels of sensitivity)	3 - Medium
Temperature unit of measure	Centigrade (Celsius) or Fahrenheit. Settings are °C and °F.	°C
Bake extension (minutes)	Adjusts the extra time at the end of a bake for each “extra time” button touch. Settings are 0 to 10 minutes.	2
Reselect product after bake	Resumes with the same product program without having to reselect it. Settings are Yes and No .	Yes
Sleep mode delay	The oven goes into sleep mode after the set minutes, providing it is up to temperature and has been through at least one bake cycle. Settings are 0 to 60.	0
8-hour countdown timer	After 8 hours, the oven gives a warning and then turns off. Touch any button for an extra hour, if required. Off / On .	Off
7-day Smart timer	On = 7 -day timer function. Off = Controls set start time depending on oven temperature.	Off
Pump time (sec)	This setting increases the pipe pressure (before steaming) only when a pump is fitted. Settings are 0.0 to 3.0 .	0.5
Chart interval (sec)	Time interval in seconds that the bars show on the heat and bake time progress charts. Settings are 1 to 60.	5
Sounder select	Set as External or Onboard sounder.	External
Sounder tone	Select a tone – Voice , Tone , or Off .	Tone
Sounder volume	Adjust to suit the volume required for the onboard sounder. Settings are 0 to 15.	8
Shortcut buttons 1 fn to 5 fn	It gives the choice of what buttons are active and in which order they appear on the options screen. Settings are Fav (Favourites), Progs (Programs), Manual bake, Multi bake, 7-Day timer, and [Blank] (not used). (Settings for 6 fn cannot be changed)	1 fn = Fav 2 fn = Progs 3 fn = Manual 4 fn = 7-Day 5 fn = [Blank]

High-level settings

(Settings)

See Table 10 for a guide to the high-level settings.

SETTINGS SCREEN

Touch **High level settings** to open the settings screen.

1



Enter the High Level passcode and then touch **OK**.

2



PASSCODE SCREEN

The **High Level Settings** menu screen then appears. Use the arrow buttons to scroll through all the options. Change each one as required.

3

Change the Supervisor passcode

Change the High Level passcode

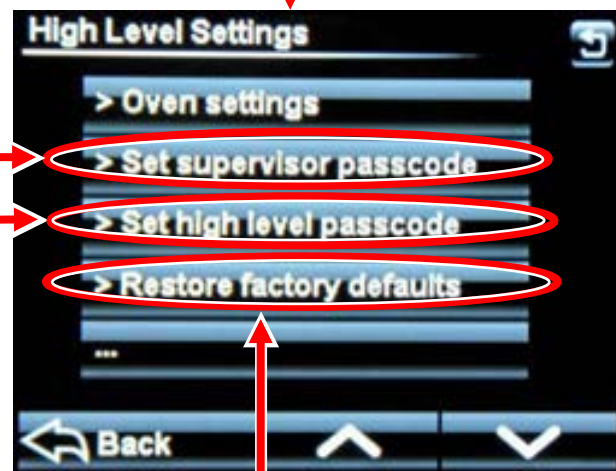

Touching **Oven settings** takes you to the settings menu. See page 49 for guidance.

Restores all screens to original (factory default) settings

Table 10: Oven settings explained (high level)

Oven setting	Explanation of the settings	Default
Oven type	Always fixed to DX for this oven.	DX
Maximum bake temperature	It can be set from 250 °C (480 °F) up to 300 °C (572 °F) .	250 (°C) or 480 (°F)
Temperature offset	Adjusts the display of the actual temperature in the oven. Usually, this is kept set to 0 .	0
Bake hysteresis	Sets bake temperature cycling around a set point. (Above and below. Settings for above/below thresholds are 1 to 20).	2
Bake cycle setpoint only	No = Shows the set temperature point and actual temperatures on screen Yes = Shows the set temperature point only	No
Manual default temperature	Set for manual program default temperature.	150 (°C) or 302 (°F)
Sleep fallback	Set the temperature required to be maintained by the oven while sleeping. Setting are 100 to 200 (°C) / 212 to 392 (°F) .	170 (°C) or 338 (°F)
Sleep hysteresis	Keeps “sleep mode” temperature cycling around a set point. Settings for above/below thresholds are 1 to 20 (°C) .	2 (°C)
Ready accept high	The highest temperature for the oven to display “Ready”.	15
Ready accept low	The lowest temperature for the oven to display “Ready”.	-10
Steam type	Plate or Spray – but keep this set to Plate .	Plate
Top gain	Top and bottom heat gains. Settings are 0 to 255 °C (32 to 491 °F)	50 (°C) or 122 (°F)
Bottom gain		
Mono constant	Factory set. Do not change unless instructed to do so.	(Factory)
Steam trough temp.	<i>Not applicable to this oven.</i>	
Steam hysteresis	<i>Not applicable to this oven.</i>	
Steam trough accept	<i>Not applicable to this oven.</i>	
Light output soft start	Some lights need this for a cold start-up to stop them blowing.	Off
Heater control	Always fixed to the Contactor setting for this oven.	Contactor
I/P diagnostic	Displays inputs and outputs at the top of the screen to aid fault-finding.	Off

8. Using the USB port

 **Never use this USB port to power or recharge electronic devices e.g., mobile phones. Incorrect usage causes damage to the oven and could result in a fire.**

Ensure the start screen is showing. **1** 

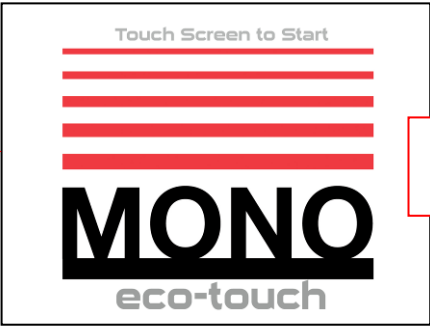
 **START SCREEN**

Insert the USB memory stick into the socket on the oven panel. (A rubber plug may have to be removed first). **2** 

Note:
The USB stick only fits in one way.
Do not force it into the socket.



Wait for the USB symbol to finish moving. **3** 



If old firmware is found, the firmware version screen will appear. **4** 

4.1. Touch **OK** to update firmware.
4.2. Wait until the eco-touch controller has restarted after the update is complete.
4.3. Remove the USB stick or touch **Cancel** to choose other items to update or change. (See next page)

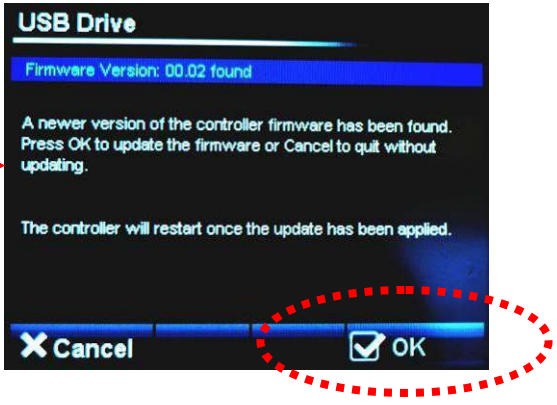

Other items to update

(Using the USB port)

Choose action you would like to do (e.g. **Load Products**).

5

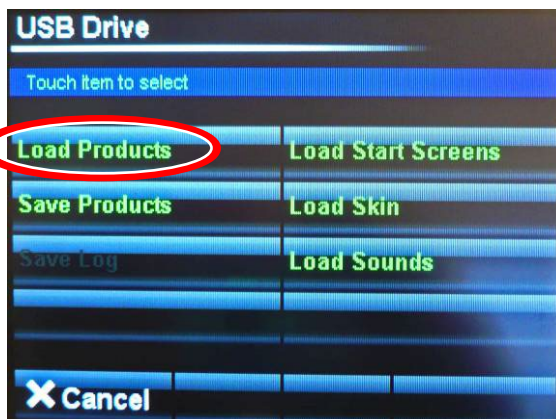

Select the file required (e.g. **MALEVOX**).

6

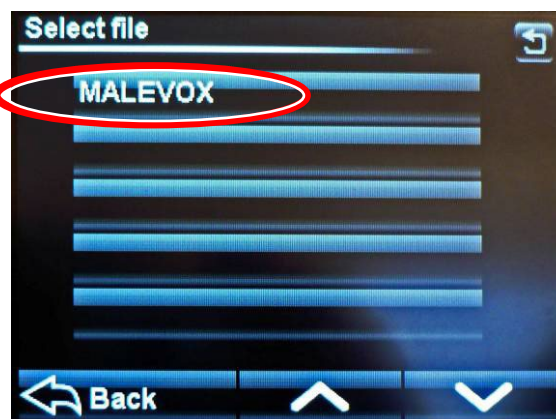

Remove the USB stick when confirmation of "file loaded ok" is seen.

7

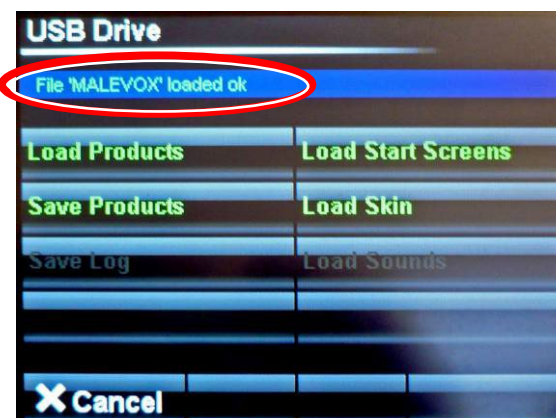

Notes on using USB sticks

(Using the USB port)

For a USB stick (pen drive) to function correctly on a Mono oven with a port, it must have the following folder structure as a root folder.

Mono

(Create 5 sub-folders within the **Mono** folder)

Firmware

Products

Skins

Sounds

Startup

The oven automatically finds the **Mono** folder after plugging the USB stick into the port. Use any USB stick (as it does not need to be blank), but the Mono folder must be in the root.

Place your recipe and product files in the “**Products**” sub-folder. The most used sub-folders are **Product Files**, **Skins**, and **Startup Screens**.

SKINS

These files control the way the screen looks in different modes.

- **Pictorial** type skins are for when the screen displays categories using pictures.



- **Numerical** type skins are for when the screen displays categories using numbers.



PRODUCTS (PROGRAM FILES)

These files contain the information for baking each product, e.g. bread, buns, and cakes.

STARTUP SCREENS

These files show a picture or logo when the oven starts or wakes up.



9. Diagnostics

Touch **Settings** to open the settings menu screen.

1



OPTION SCREEN

Touch **Diagnostics** to open the diagnostics display.

2

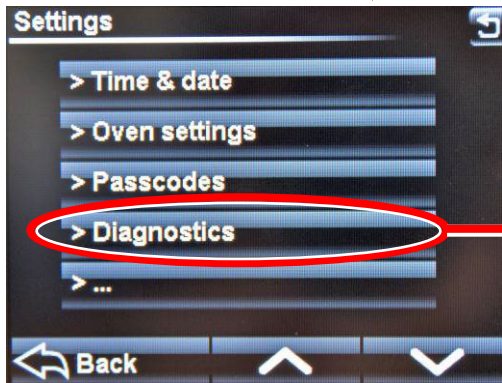

SETTINGS SCREEN

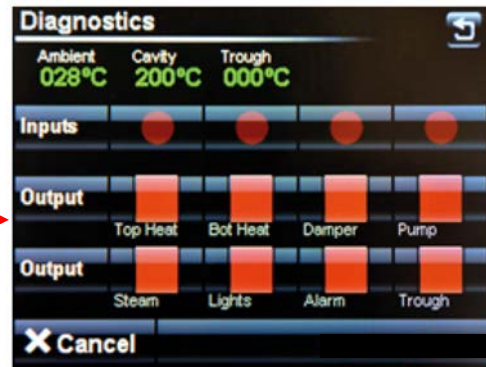

DIAGNOSTICS SCREEN

Inputs are highlighted when a signal is received, e.g. a door is open.

Touch the required output and a signal is sent to that item. The output being checked is highlighted when active. To stop the output, touch it again.

3

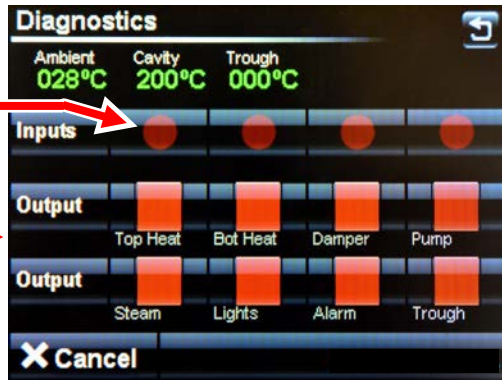

(Blank Page)

10. Passcodes

Default passcodes

Table 11: Security level and passcodes

Security level	Passcode
Supervisor (low level)	123456 (default)
High-level	654321 (default)
Master	314159 (fixed)

To stop unauthorised changes to the oven setup, it is suggested that this section is removed from this manual and kept in a safe place for future reference.

If tampering could be a problem, it is a good idea to change the passcodes at regular intervals.

How to change the passcodes

Note: Passcodes are required to navigate through these screens and make changes.

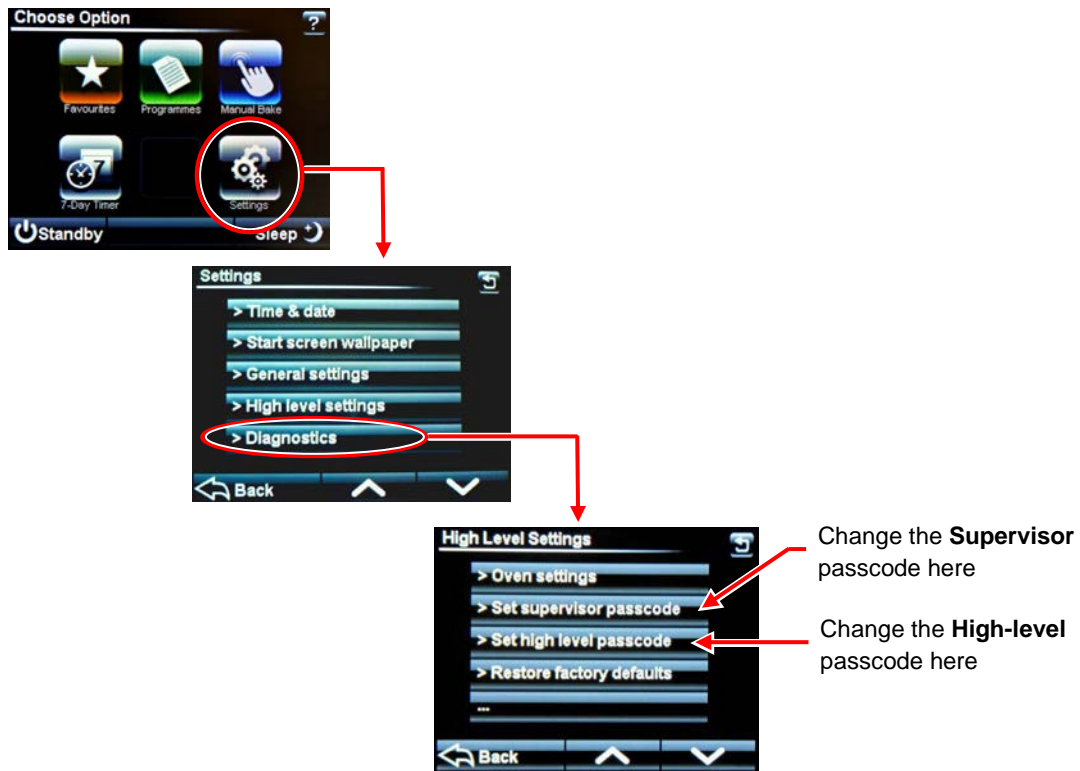

(Blank Page)

11. Cleaning

Daily cleaning instructions



Isolate the oven from the electrical supply before cleaning.



Take care that water does not enter the control-panel mounting or roof-mounting fan.
Never use a pressure washer or water hose to clean the oven.

Procedure

1. Sweep any debris out of the oven **after** it has been allowed to cool.
NOTE: Use a vacuum cleaner with metal attachments (i.e. able to take the heat), if available.
2. Brush down and wipe the oven front, back and sides with a damp cloth.
3. Spot clean outside with a damp cloth, soaked in a solution of mild detergent and hot water.
Ensure excess water is not applied around the electrical panels.

Weekly cleaning instructions



Isolate the oven from the electrical supply before cleaning.



Take care that water does not enter the control-panel mounting or roof-mounting fan.
Never use a pressure washer or water hose to clean the oven.



Do not stand on the roof.

Procedure

1. Complete the daily cleaning procedure, as above.
2. Use a nylon brush to scrub the wheels with a mild detergent and hot water.
NOTE: Using too much water eventually rusts the metalwork.
3. Ensure the oven roof area is clear of debris and dust build-up.

12. Troubleshooting

None of the decks switched on

- Is the oven's main isolator set to the on (I) position?
- Check if a time clock of the bakery's mains power supply is working (if fitted).
- Is the clock set correctly to power the oven at the required day and time?

One deck has not switched on

- Check if the individual deck timer is to come on at a specific time.

Uneven or patchy bake

- The deck door is open too often or too long whilst loading (front pale, back burnt).
- Uneven loading.
- Faulty element.
- Top or bottom deck elements are not functioning.
- No supply voltage across a phase.

Actual temperature is far exceeding the set temperature

- When empty, the temperature of a deck oven can exceed the set baking temperature. This overheat is marginal when the deck is full of product. If the elements are continuing to work after the set temperature has been reached, call MONO service.
(Please allow up to 15 °C (59 °F) difference before diagnosing a fault condition).

Poor recovery of actual temperature after loading

- Doors may have been left open too long during loading, allowing heat to escape.
- Damper may have been left open during loading/baking, allowing heat to escape.
- Top or bottom heat may not be working.
- No supply voltage across a phase.

Steam system not operating correctly







- Is water connected correctly?
- Is the tap to each deck in the on position?
- Has enough time elapsed since the last steaming?

Once steamed, the oven does not steam until the steam unit has recovered heat, typically 3 to 10 minutes depending on the program selected.

13. Service

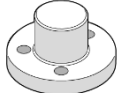
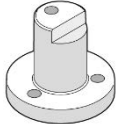
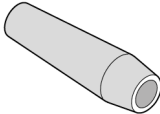
Oven spares

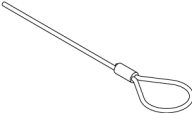
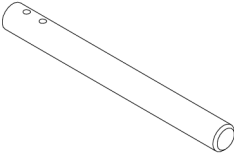
Table 12: Oven spares

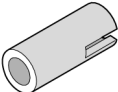
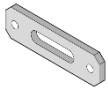
Spare		Part number
Frosted glass (lights)		257-02-00027
Plain glass (lights)		257-02-00028
Door bumper stop		257-03-00094
Hinge pin, right-hand-side		257-03-00005
Hinge pin, left-hand-side		257-03-00009
Black door handle		A900-27-192
Door spring		257-03-00017
Wire rope		257-03-00024
Spring retaining pin		257-03-00025
Pulley		257-03-00015
Pulley spindle		257-03-00013
Damper drive coupling		257-07-00007
Element gasket		245-02-01300

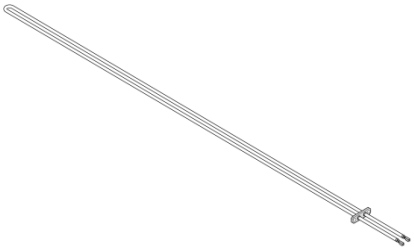
Spare		Part number
24v 20w Dichroic Lamp		B855-94-008
Top heat element, 0.66 kW Top heat element, 0.4 kW Bottom heat element, 0.5 kW		B854-04-102 B854-04-100 B854-04-101

Service Information

If a fault arises, please do not hesitate to contact the MONO Customer Service Department. Quote the machine serial number on the silver information plate of the machine and on the front cover of this manual.



MONO Equipment

Queensway, Swansea West Industrial Park, Swansea, SA5 4EB UK

+44/0 1792 561234

Spares +44/0 1792 564039

Email: mono@monoequip.com

www.monoequip.com

Disposal

When the oven comes to the end of its working life, dispose of parts in the appropriate place by recycling or other means as the law permits at that time.

14. Maintenance

General maintenance



WARNING

- This appliance must be maintained at regular intervals. The frequency of maintenance will depend upon your specific use and location. The maximum service interval should be 12 months.
- Service and maintenance should only be undertaken by suitably qualified, trained, and competent engineers.
- You must immediately report any damage or defect arising with the appliance.
- Unsafe equipment is dangerous. Do not use the appliance. Isolate the power supply and contact MONO or your appointed service agent.

- Check for frayed or bare cables.
 - **Do not** use the machine if frayed or bare cables are visible.
- Follow cleaning instructions (see **Cleaning** on page 61).

Light bulb replacement



WARNING

- Disconnect from the supply before replacing light bulbs.

How to replace the 24Vac 20w lamp (part number B855-94-008)

1. Unscrew the plate (A) next to the light to be replaced.
 - Keep the hex head socket screws (B) safe.

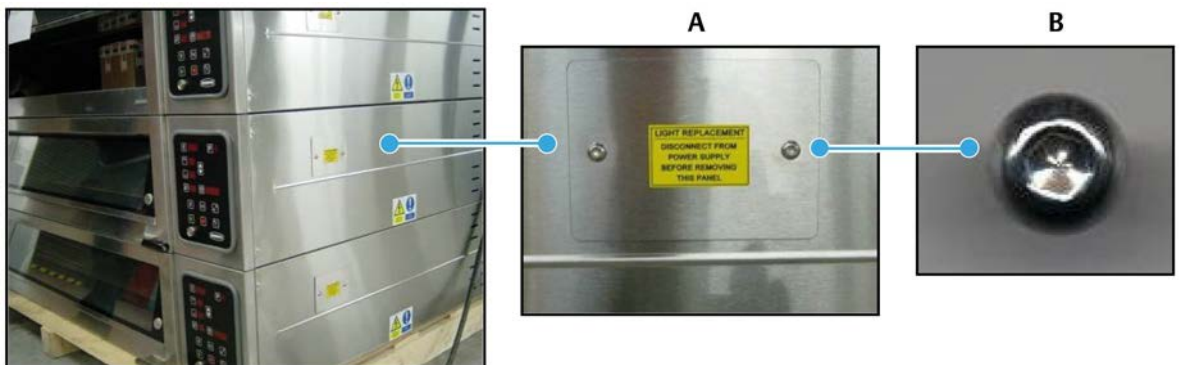

2. Slide the fitting out.



3. Remove the light from the holding slot and unclip from the cable.



4. Replace the light and refit all parts.



5. Reconnect the power supply and test.

15. Oven Electrics

Table 13: Parts list for the electrical drawings (3-tray wide)

Reference in drawing	Description	Part number
F1 (single-phase only)	Heaters MCB	B872-22-007
F2 (single-phase only)	Heaters MCB	B872-22-007
F3 (single-phase only)	Heaters MCB	B872-22-007
F4	Control power supply MCB	B872-22-062
F5	Overheat thermostat	B888-30-014
T1	Control circuit power supply	B801-93-005
K1	Top heat contactor	B801-08-021
K2	Bottom heat contactor	B801-08-021
Y1	Water solenoid (8 mm pipe)	A900-34-365
H1	Interior light	B855-94-008
B1	Oven thermocouple	B873-95-007
U1	Main ECO printed circuit board	158-25-80000
D1	Damper solenoid	B749-83-004
R1	Top heat element, 1.0 kW	B854-04-093
R2	Top heat element, 0.6 kW	B854-04-091
R3	Top heat element, 0.6 kW	B854-04-091
R4	Top heat element, 0.6 kW	B854-04-091
R5	Top heat element, 0.6 kW	B854-04-091
R6	Top heat element, 0.6 kW	B854-04-091
R7	Top heat element, 0.6 kW	B854-04-091
R8	Bottom heat element, 0.75 kW	B854-04-092
R9	Bottom heat element, 0.6 kW	B854-04-091
R10	Bottom heat element, 0.6 kW	B854-04-091
R11	Bottom heat element, 0.6 kW	B854-04-091
R12	Bottom heat element, 0.6 kW	B854-04-091
R13	Bottom heat element, 0.6 kW	B854-04-091
R14	Bottom heat element, 0.6 kW	B854-04-091

Table 14: Parts list for the electrical drawings (2-tray wide)

Reference in drawing	Description	Part number
F1 (single-phase only)	Heaters MCB	B872-22-006
F2 (single-phase only)	Heaters MCB	B872-22-006
F3 (single-phase only)	Heaters MCB	B872-22-006
F4	Control power supply MCB	B872-22-062
F5	Overheat thermostat	B888-30-014
T1	Control circuit power supply	B801-93-005
K1	Top heat contactor	B801-08-021
K2	Bottom heat contactor	B801-08-021
Y1	Water solenoid (8 mm pipe)	A900-34-365
H1	Interior light	B855-94-008
B1	Oven thermocouple	B873-95-007
U1	Main ECO printed circuit board	158-25-80000
D1	Damper solenoid	B749-83-004
R1	Top heat element, 0.65 kW	B854-04-102
R2	Top heat element, 0.4 kW	B854-04-100
R3	Top heat element, 0.4 kW	B854-04-100
R4	Top heat element, 0.4 kW	B854-04-100
R5	Top heat element, 0.4 kW	B854-04-100
R6	Top heat element, 0.4 kW	B854-04-100
R7	Top heat element, 0.4 kW	B854-04-100
R8	Bottom heat element, 0.5 kW	B854-04-101
R9	Bottom heat element, 0.4 kW	B854-04-100
R10	Bottom heat element, 0.4 kW	B854-04-100
R11	Bottom heat element, 0.4 kW	B854-04-100
R12	Bottom heat element, 0.4 kW	B854-04-100
R13	Bottom heat element, 0.4 kW	B854-04-100
R14	Bottom heat element, 0.4 kW	B854-04-100

Table 15: Parts list for the electrical drawings (1-tray wide)

Reference in drawing	Description	Part number
F1 (single-phase only)	Heaters MCB	B872-22-006
F2 (single-phase only)	Heaters MCB	B872-22-006
F3 (single-phase only)	Heaters MCB	B872-22-006
F4	Control power supply MCB	B872-22-062
F5	Overheat thermostat	B888-30-014
T1	Control circuit power supply	B801-93-005
K1	Top heat contactor	B801-08-021
K2	Bottom heat contactor	B801-08-021
Y1	Water solenoid (8 mm pipe)	A900-34-365
H1	Interior light	B855-94-008
B1	Oven thermocouple	B873-95-007
U1	Main ECO printed circuit board	158-25-80000
D1	Damper solenoid	B749-83-004
R1	Top heat element, 0.325 kW	B854-04-111
R2	Top heat element, 0.2 kW	B854-04-109
R3	Top heat element, 0.2 kW	B854-04-109
R4	Top heat element, 0.2 kW	B854-04-109
R5	Top heat element, 0.2 kW	B854-04-109
R6	Top heat element, 0.2 kW	B854-04-109
R7	Top heat element, 0.2 kW	B854-04-109
R8	Bottom heat element, 0.25 kW	B854-04-110
R9	Bottom heat element, 0.2 kW	B854-04-109
R10	Bottom heat element, 0.2 kW	B854-04-109
R11	Bottom heat element, 0.2 kW	B854-04-109
R12	Bottom heat element, 0.2 kW	B854-04-109
R13	Bottom heat element, 0.2 kW	B854-04-109
R14	Bottom heat element, 0.2 kW	B854-04-109

Electrical drawings

TOP CANOPY MK 2 DECK OVEN MCB WIRING

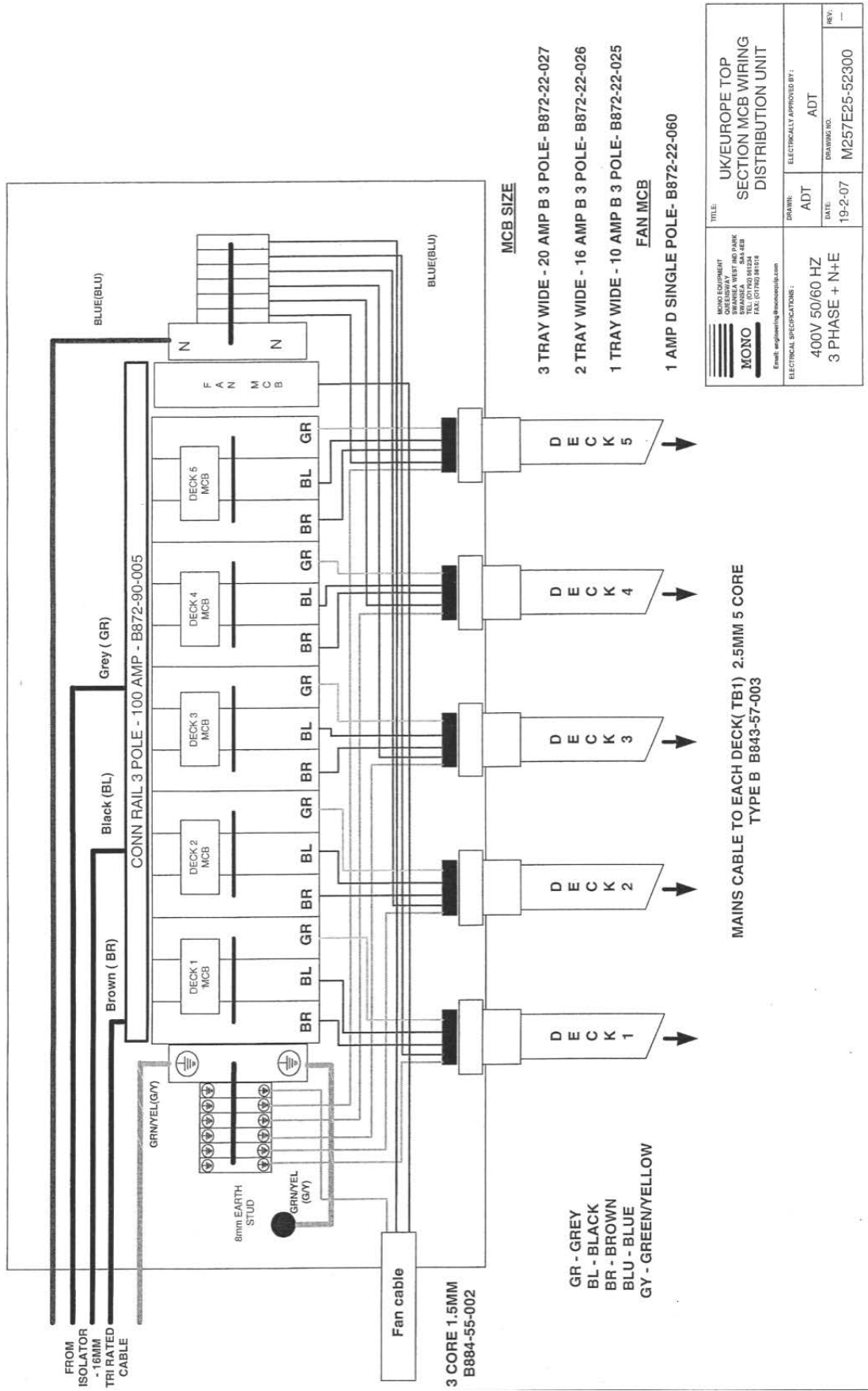

DX UK Modular MK2 Deck Oven Interlink Detail

DECKS ARE LINKED AS REQUIRED - 2, 3, 4 AND 5 HIGH

← Front Of Oven

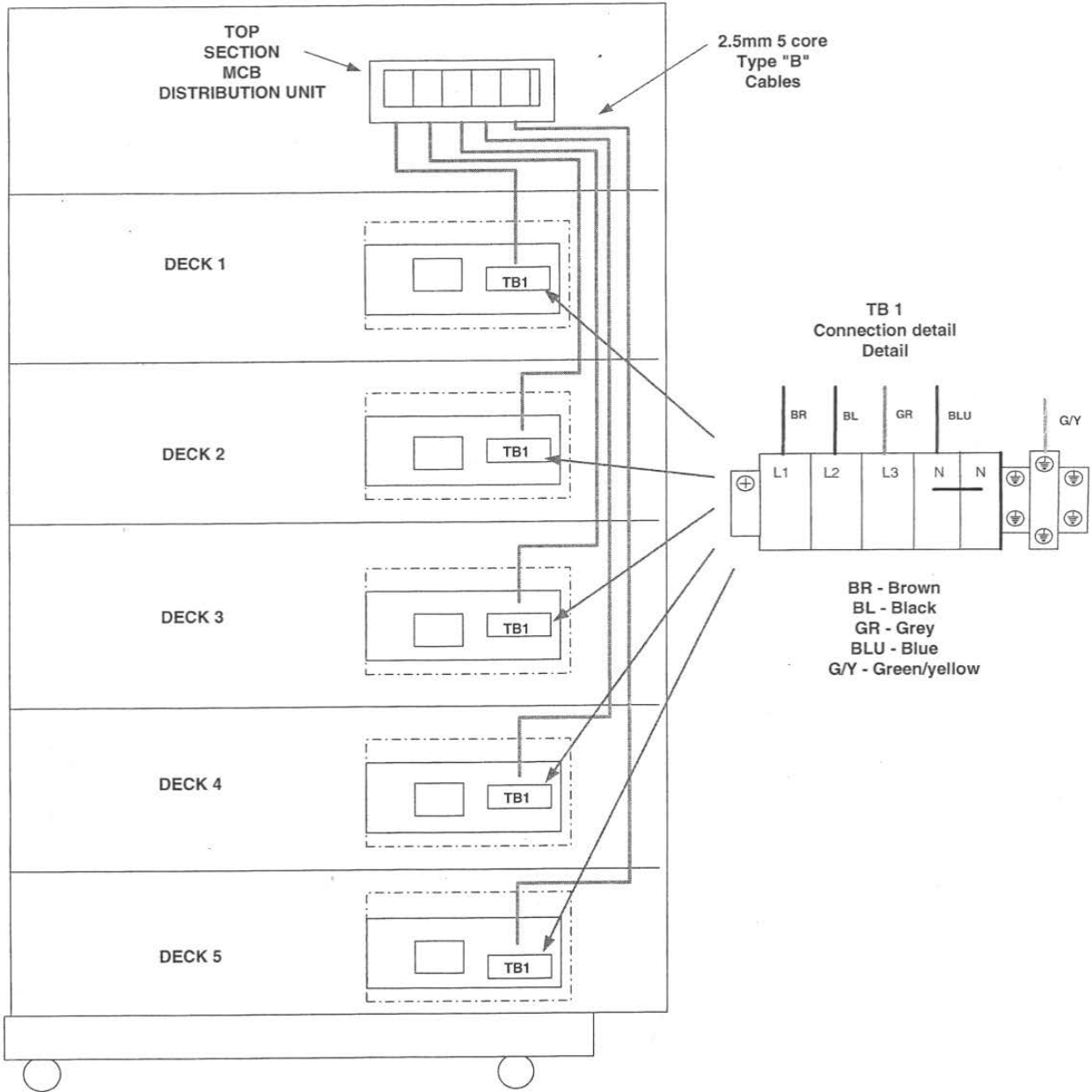

<p>MONO EQUIPMENT QUEENSWAY SWANSEA WEST IND PARK SWANSEA SA5 4EB TEL: (01792) 861334 FAX: (01792) 861016 Email: engineering@monoequip.com</p>	TITLE: UK/EUROPE MODULAR MK 2 DECK OVEN INTERLINK DETAIL		
	ELECTRICAL SPECIFICATIONS: 400V 50/60 HZ 3 PHASE + N+E	DRAWN: ADT	ELECTRICALLY APPROVED BY: ADT
	DATE: 19-2-07	DRAWING NO. M257E25-52500	REV: -

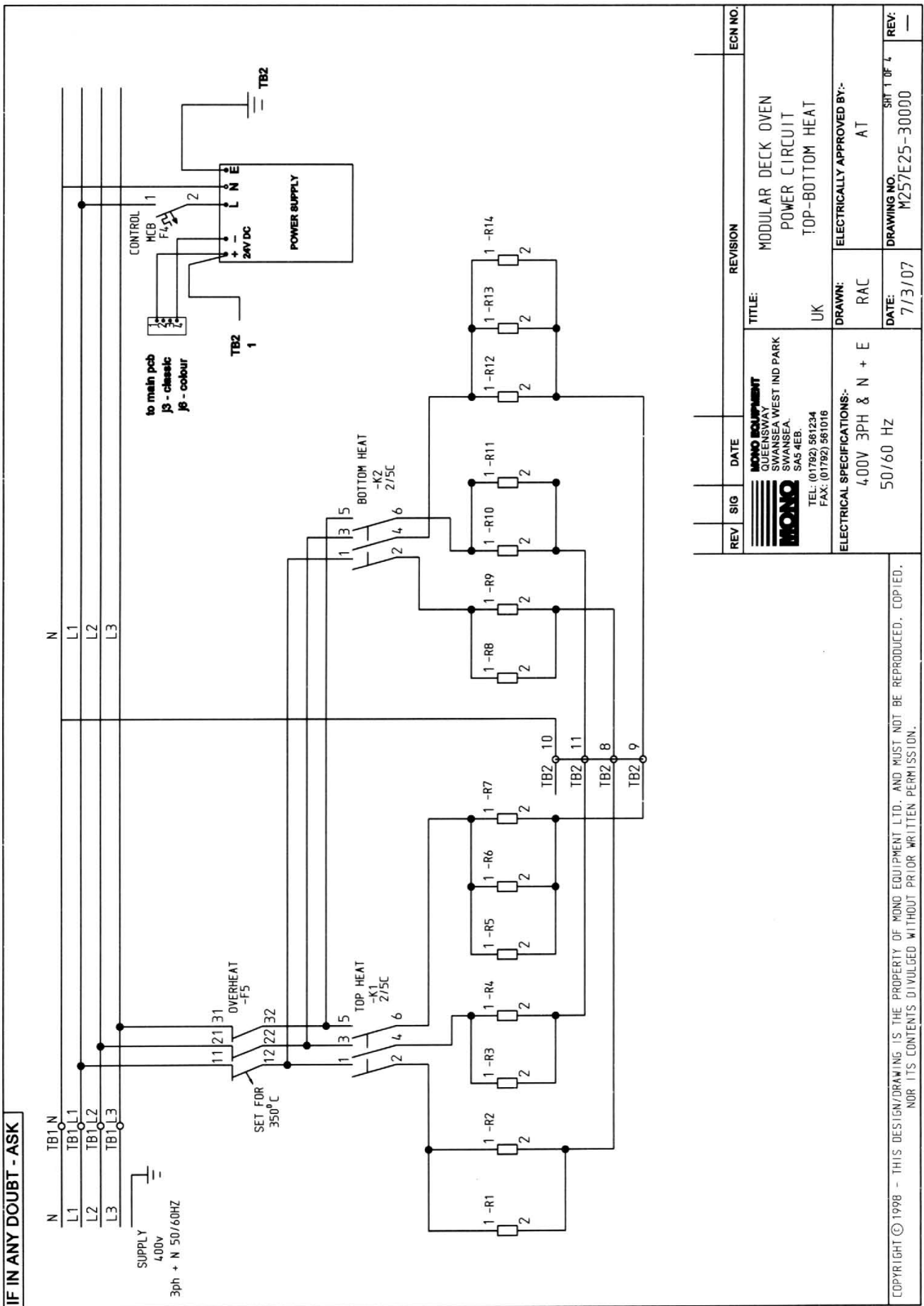

REV	SIG	DATE	REVISION	ECN NO.
			MODULAR DECK OVEN POWER CIRCUIT TOP-BOTTOM HEAT	
<p>MONO EQUIPMENT QUEENSWAY SWANSEA WEST IND PARK SWANSEA, SA5 4EB. TEL: (01792) 561234 FAX: (01792) 561016</p>		UK	DRAWN: RAC	ELECTRICALLY APPROVED BY:- AT
ELECTRICAL SPECIFICATIONS:-		400V 3PH & N + E		
		50/60 HZ		
		DATE: 7/3/07	DRAWING NO. M257E25-30000	REV: —
				SHT 1 OF 4

COPYRIGHT © 1998 - THIS DESIGN/DRAWING IS THE PROPERTY OF MONO EQUIPMENT LTD. AND MUST NOT BE REPRODUCED, COPIED, NOR ITS CONTENTS DIVULGED WITHOUT PRIOR WRITTEN PERMISSION.

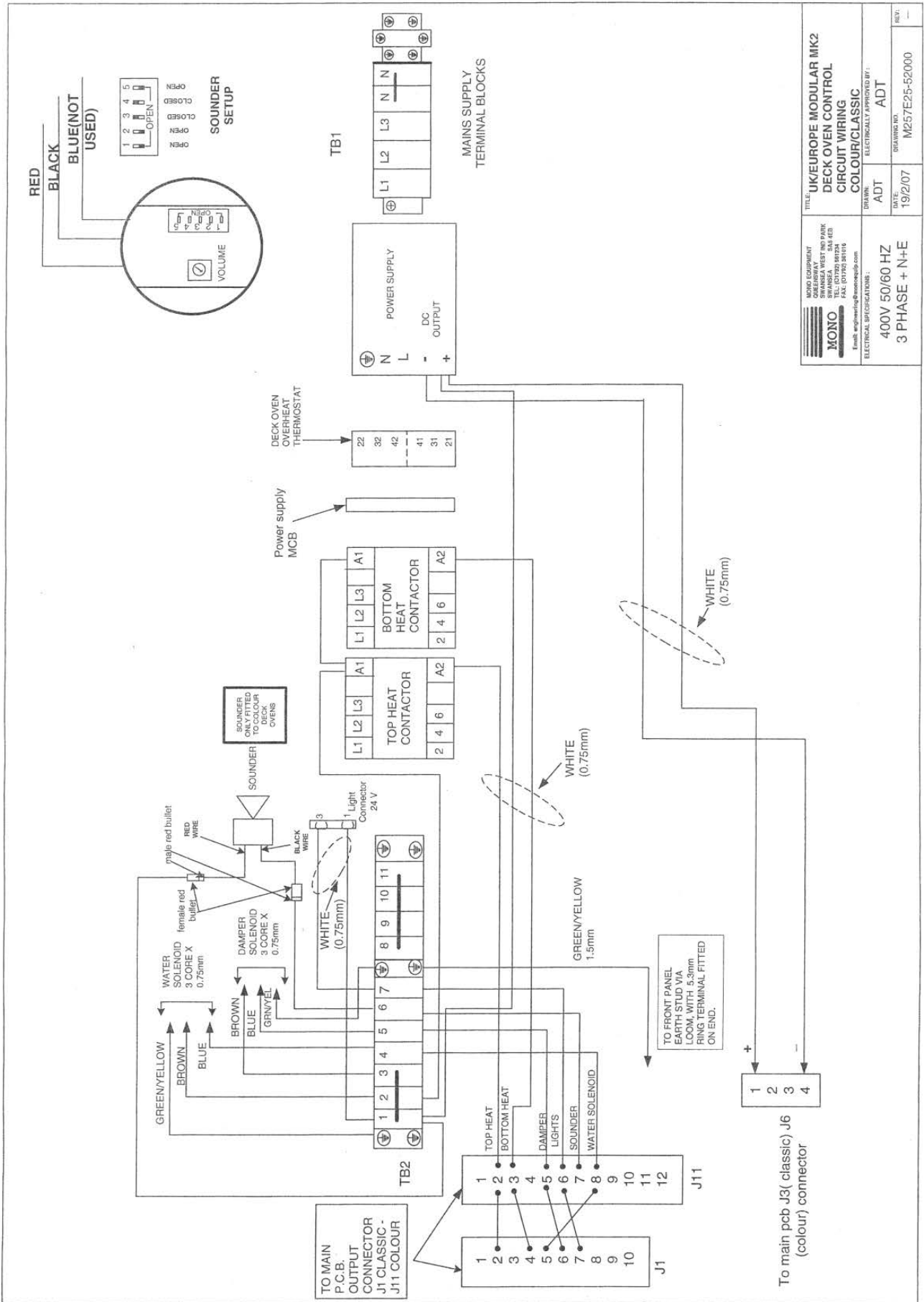

<p>MONO EQUIPMENT SWANSEA WEST INDUSTRIAL PARK SWANSEA SA1 4ED TEL: (01792) 892727 FAX: (01792) 891616 Email: engineering@monoequip.com</p>	<p>TITLE: UK/EUROPE MODULAR MK2 DECK OVEN CONTROL CIRCUIT WIRING COLOUR/CLASSIC</p>	
	<p>DRAWN: ADT</p>	<p>ELECTRICALLY APPROVED BY: ADT</p>
<p>400V 50/60 HZ 3 PHASE + N+E</p>	<p>DATE: 19/2/07</p>	<p>REV: —</p>
<p>DRAWING NO: M257E25-52000</p>		

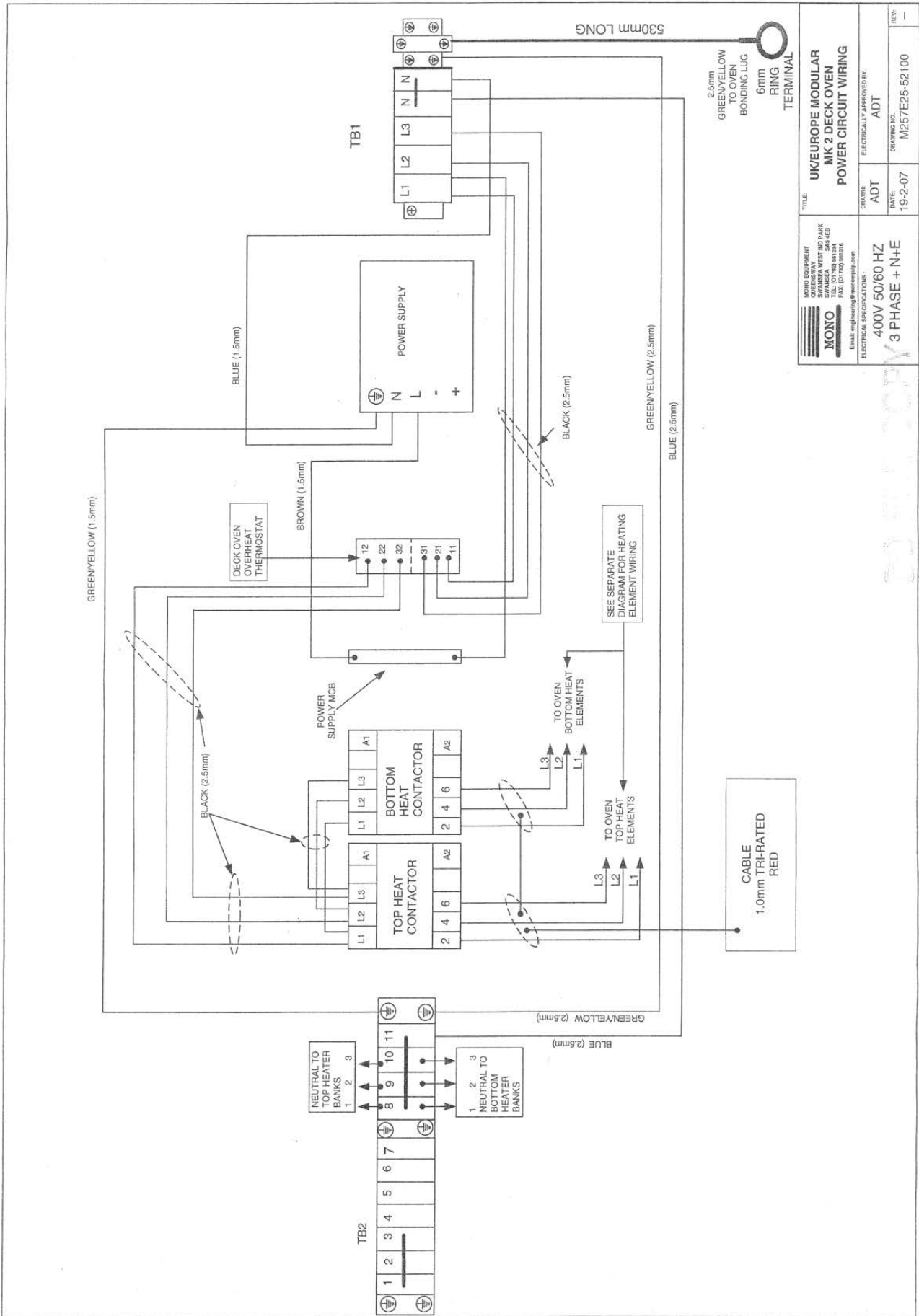

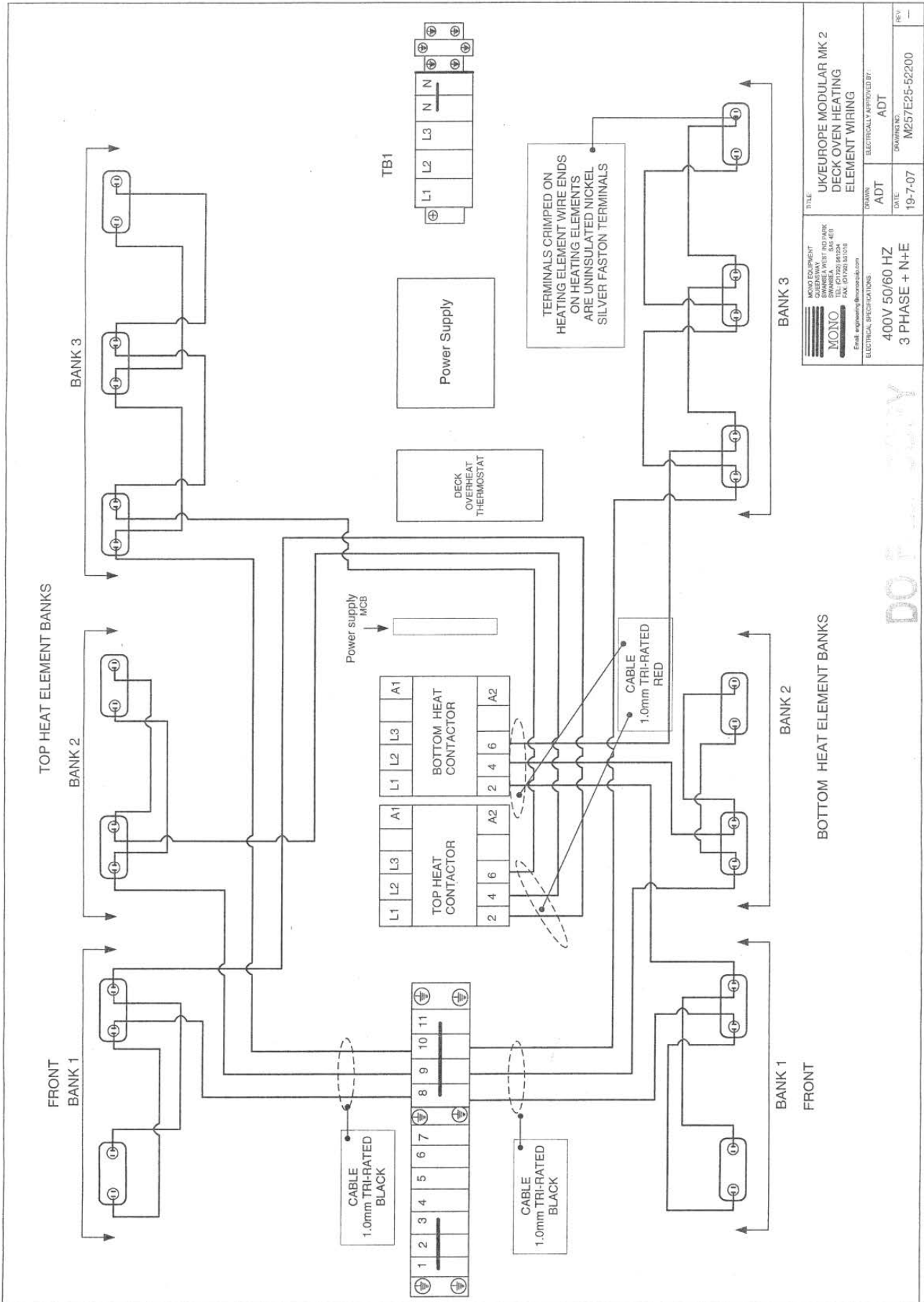

DO NOT TOUCH

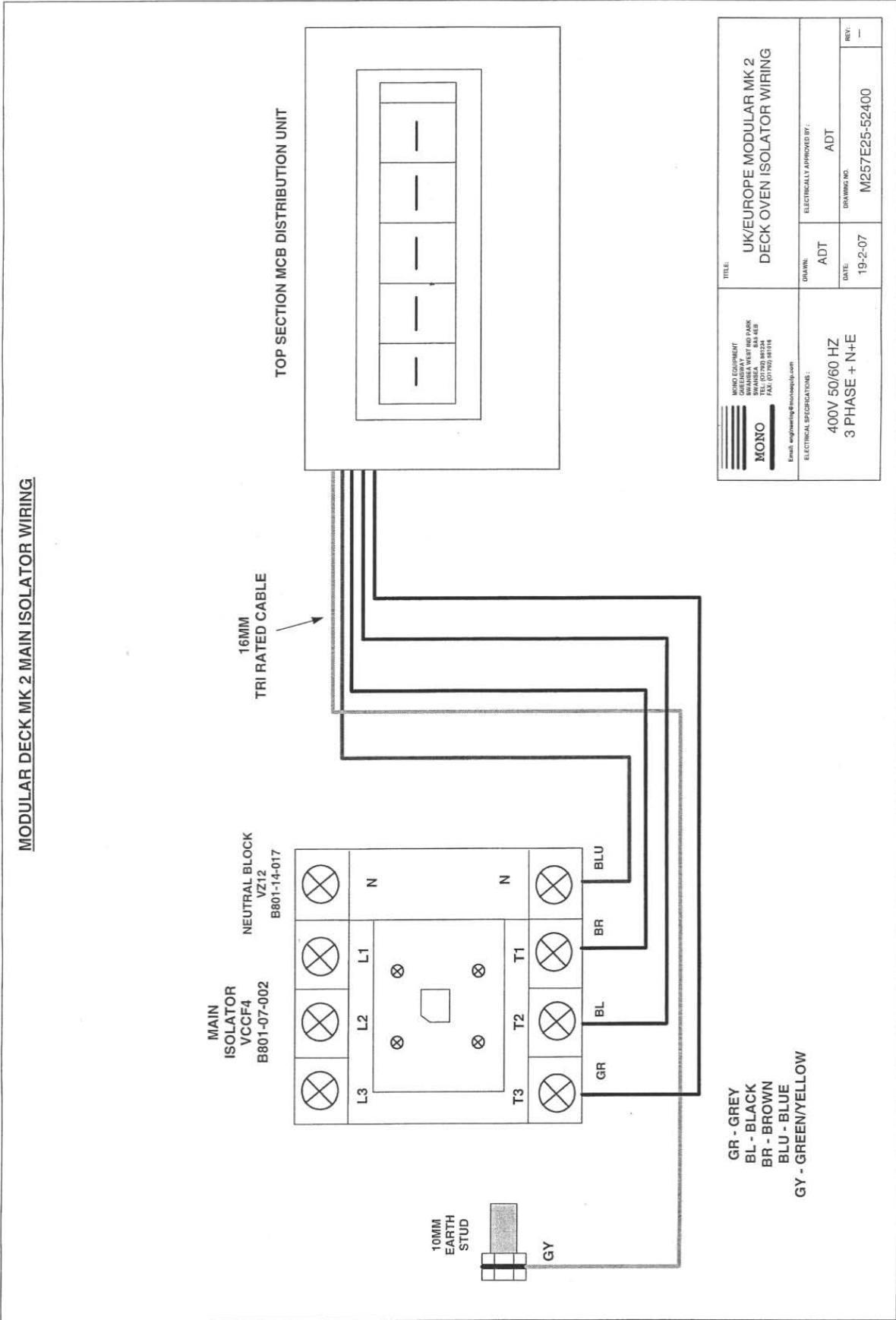

Electrical panel main components

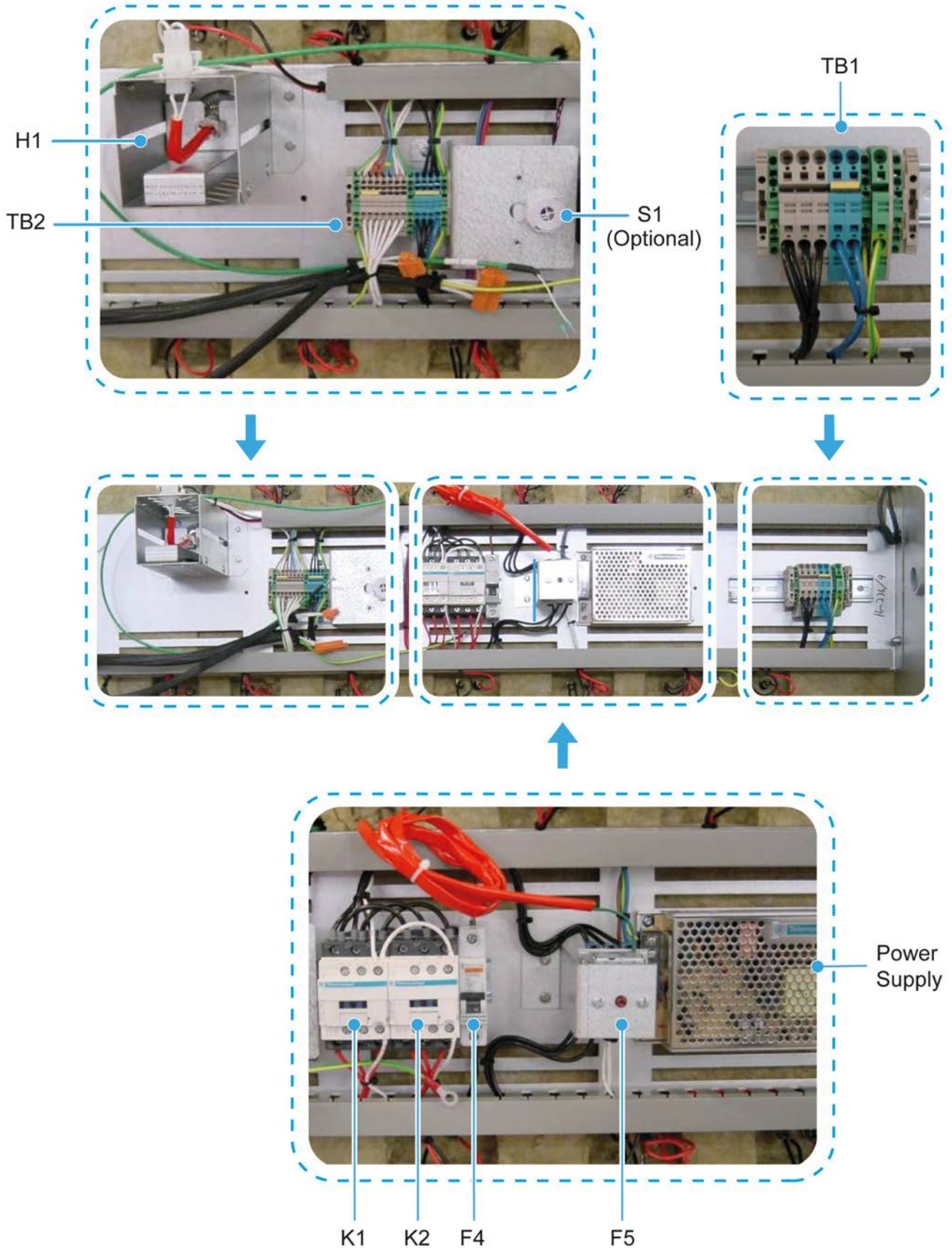
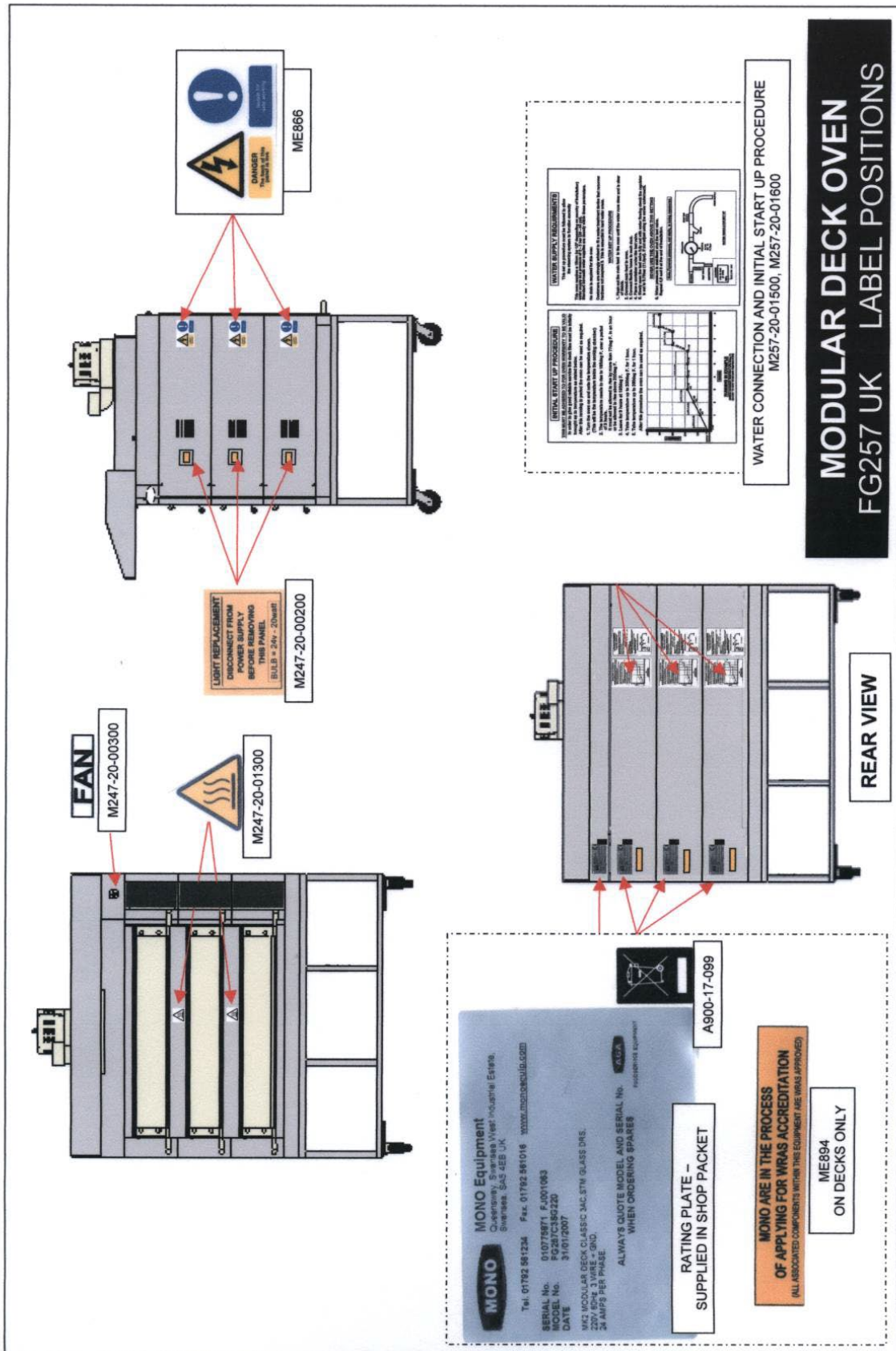

Table 16: Oven canopy layout parts list

Reference	Part description	Part number
C1	Canopy fan capacitor, 5 μ F, 400VDB, metal	B869-23-005
Q1	Canopy fan on/off switch	B895-07-005
M1	Canopy fan motor R2E225-AG01-21 (230V, 1.4 Amp, 305 Watts)	B869-75-026

16. Warning and Information Labels



(Intentional Blank Page)

MONO Equipment is the leading designer and manufacturer of bakery equipment in the United Kingdom. This proud heritage of British craftsmanship, combined with a reputation for creating high-quality, innovative products, can be traced back to its origins in 1947.

All our bakery equipment is manufactured to the most stringent NQA ISO9001:2015 & NQA ISO14001:2015 standards and is crafted using the very latest, cutting-edge technology combined with the time-honoured skills of the master craftsman.

MONO Equipment truly excels in providing tailor-made solutions to a diverse range of clients, from the small independent artisan baker to the large retail chains found on every high street and in every out-of-town shopping centre. We can supply everything from a simple Food-2-Go cafe oven to the entire list of bakery equipment needed to set up a full scratch bakery.



MONO Equipment Limited

Queensway
Swansea West Industrial Park Swansea
SA5 4EB

Tel: +44 (0)1792 561 234 (Switchboard)
Tel: +44 (0)1792 564 000 (UK Sales)
Tel: +44 (0)1792 564 004 (International Sales)
Tel: +44 (0)1792 564 048 / +44 (0)1792 564 049 (Spares)
Fax: +44 (0)1792 561 016

Email: sales@monoequip.com
Web: www.monoequip.com



*Scan using your smart phone to
view our website.*

