

MonoEquip.com

MX Eco-touch Rotary Rack Gas Oven (FG166)

Enter **Serial No.** here. _____

In the event of an enquiry please quote this serial number.



MXT ROTARY RACK OVEN

SET UP AND OPERATION OF OVEN

(With programming instructions)

GAS

ECOTOUCH CONTROL



Total Quality. Assured.

EU PRODUCT SURVEILLANCE CERTIFICATE

This is to certify that factory production control systems in place for the appliances covered under EU Type Examination certificates listed, have been examined under Annex III, section 2, Module C2 Conformity to type based on quality assurance of the production process, of the Council Regulation (EU) 2016/426 of 9th March 2016 on the approximation of the laws of the Member States relating to appliances burning gaseous fuels, and have been found to be in conformity to the type as described in the EU type-examination certificates and to satisfy the essential requirements listed in Annex I of the same directive. The manufacturer is hereby licenced to affix the Intertek Notified Body number (0359) to the appliances listed within this certificate

Applicant: Mono Equipment Limited

**Address: Queensway, Swansea West Industrial Park
Swansea. SA5 4EB. Wales**

Country: United Kingdom

Contact: Mr. Alex Davies

Phone No: + +44 (0) 1792 561234

Email: adavies@monoequip.com

Manufacturer: Mono Equipment Limited

**Address: Queensway, Swansea West Industrial Park
Swansea. SA5 4EB. Wales**

Country: United Kingdom

Contact: Mr. Alex Davies

Phone No: +44 (0) 1792 561234

Email: adavies@monoequip.com

Party Authorised To Apply Mark:

Certificate Number:

Period Valid:

Same as Manufacturer

UK-LHD-0359-00010335

From: APRIL 2020

To: MARCH 2022



This certificate only relates to those products detailed in the following surveillance report number:

Report No: 104466762LHD-001

Intertek Certificate

The issued document and statement(s) herein refers only to a presumption of conformity in accordance with Regulation (EU) 2016/426. However, it is the manufacturers sole responsibility to affix the CE logo and, by doing so, confirms full compliance and conformity to all other European mandatory directives and regulations that may also apply"

This certificate is for the exclusive use of Intertek's client and is provided pursuant to the agreement between Intertek and its Client. Intertek's responsibility and liability are limited to the terms and conditions of the agreement. Intertek assumes no liability to any party, other than to the Client in accordance with the agreement, for any loss, expense or damage occasioned with the use of this Certificate. Only the Client is authorized to permit copying or distribution of this Certificate. Any use of the Intertek name or one of its marks for the sale or advertisement of the tested material, product or service must first be approved in writing by Intertek.

The manufacturer must inform Intertek Testing and Certification Limited if any mechanical or material changes made to the products covered by this certificate, as unauthorised modifications could invalidate this certificate.

Intertek Testing & Certification Ltd, Registered office: Academy Place, 1-9 Brook Street, Brentwood, Essex, CM14 5NQ, United Kingdom. Registered No: 3272281 (England), VAT No: GB 672-7639-96-011

Name: S Yathunathan

Title: Business Manager

Signature: *S. Yathunathan*

Issue date: 23 October 2020

Certification body:

Intertek Testing & Certification Ltd.

United Kingdom (Notified Body 0359)

Authentication of this Certificate can be

confirmed at: info.gas@intertek.com





EU QUALITY SYSTEM SURVEILLANCE CERTIFICATE

Product Type:	Gas Fired MXT Rotary Rack Oven		
Model No.:	Issuing Notified Body	EC Type Examination Certificate No.:	Product Identification No.
Model FG166-G11RH Model FG166-G11LH	Intertek Testing & Certification Ltd	UK-LHD-0359-0000294	0359CR294
Scope:	Gas Category	Country of Destination	Supply Pressure
	I _{2H}	AT, CH, CY, CZ, DK, EE, ES, FI, FR, GB, GR, HU, IE, IT, LT, LU, LV, NL, NO, PT, TR, SE, SI, SK.	20mbar

In accordance with EC NOTICE TO STAKEHOLDERS WITHDRAWAL OF THE UNITED KINGDOM AND EU RULES IN THE FIELD OF INDUSTRIAL PRODUCTS dated 13 March 2020.

This issued certificate - Certificate No: UK-LHD-0359-0001033S

and supporting Technical Construction File underwent a legal transfer of new ownership by signed agreement between the named applicant on this certificate and the 3rd party bodies involved in the transfer from NB0359 to NB2575 on 22 December 2020

Name: **Sandro Zornio**

Position: **GAR Certification Manager**

Signature: 

Date: 22/12/2020

Revisions and comments

DD/MMM/YYYY	Amended by	Project No.	Test Report No	Reason for revision
				First issue – None



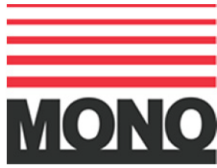

DECLARATION OF CONFORMITY

We hereby declare that this machine complies with the essential health and safety requirements of :-

- The Machinery Directive 2006 / 42 / EC
- The Low voltage Directive 2006 / 95 / EC
- The requirements of the Electromagnetic Compatibility Directive 2004 / 108EC, 91 / 263 / EEC, 92 / 31 / EEC
- The General Safety of Machinery and food processing Standards applicable
- Materials and Articles intended to come into contact with food - Regulation (EC) No. 1935 / 2004
- Good manufacturing practice for Materials intended to come into contact with food - Regulation (EC) No. 2023 / 2006

Signed	
D. Osmundsen – Quality and Conformance Manager	

Date	
-------------	--

Machine FG Code.		Machine Serial No.	
-----------------------------	--	-------------------------------	--

A technical construction file for this machine is retained at the following address:

MONO EQUIPMENT
Queensway,
Swansea West Industrial Park,
Swansea
SA5 4EB
UK

MONO EQUIPMENT is a business name of **AFE GROUP Ltd**
Registered in England No.3872673 VAT registration No.923428136

Registered office: Unit 35,
Bryggen Road,
North Lynn Industrial Estate,
Kings Lynn Norfolk,
PE30 2HZ

SAFETY SYMBOLS

The following safety symbols are used throughout this product documentation. Before using your new equipment, read the instruction manual carefully and pay special attention to information marked with the following symbols.



WARNING

Indicates a hazardous situation which, if not avoided, will result in death or serious injury.



WARNING

Indicates a hazardous situation which, if not avoided, will result in electric shock.



CAUTION

Indicates a hazardous situation which, if not avoided, will result in minor or moderate injury.

ELECTRICAL SAFETY AND ADVICE REGARDING SUPPLEMENTARY ELECTRICAL PROTECTION

Commercial bakeries, kitchens and food service areas are environments where electrical appliances may be located close to liquids, or operate in and around damp conditions, or where restricted movement for installation and service is evident.

The installation and periodic inspection of the appliance should only be undertaken by a qualified, skilled and competent electrician, and connected to the correct supply suitable for the load as stipulated by the appliance data label.

The electrical installation and connections should meet the necessary requirements of the local electrical wiring regulations and any electrical safety guidelines.

We Recommend:

- Supplementary electrical protection with the use of a residual current device (RCD)
- Fixed wiring appliances incorporate a locally situated switch disconnector to connect to, which is easily accessible for switching off and safe isolation purposes. The switch disconnector must meet the specification requirements of IEC 60947.

Your attention is drawn to:

BS 7671:2018 – Guidance Note 8 – 8.13 : Other locations of increased risk

It is recognised that there may be locations of increased risk of electrical shock other than those specifically addressed in Part 7 of BS 7671. Examples of such locations could include laundries where there are washing and drying machines in close proximity, and water is present, and commercial kitchens with stainless steel units, where once again, water is present. Where, because of the perception of additional risks being likely, the installation designer decides that an installation or location warrants further protective measures, the options available includes:

- Automatic Disconnection of Supply (ADS) by means of a residual current device having a residual operating current not exceeding 30 mA;
- Supplementary protective equipotential bonding; and
- Reduction of maximum fault clearance time.

The provision of RCDs and supplementary bonding must be specified by the host organisation's appointed installation designer or electrical contractor and installed by a suitably qualified and competent electrician so as to comply with Regulations 419.2 and 544.2.



The supply to this machine must be protected by a **30mA Type A RCD**

CONTENTS

	PAGE	
Section - 1	Introduction	10
Section - 2	Overall Dimensions	11
Section - 3	Specifications	12
Section - 4	Safety	16
Section - 5	Installation	19
Section - 6	Isolation	23
Section - 7	Cleaning Instructions	24
Section - 8	General Maintenance Instructions	25
Section - 9	Operation	27
	9- 1.0 baking using favourites	28
	9- 2.0 baking using manual menu	31
	9- 3.0 baking using programmes	34
	9- 4.0 creating a program	37
	9- 5.0 setting 7-day timer	43
	9- 6.0 settings	44
	9- 7.0 using usb port/stick	51
	9- 8.0 diagnostics	54
Section - 10	Troubleshooting	55
	Setting air slots	56
Section - 11	Spares and Services	57
Section - 12	Electrical information	58
Section - 13	Spares	66

Failure to adhere to the cleaning and maintenance instructions detailed in this booklet could affect the warranty of this machine.



NOTE

All reference to RIGHT HAND ovens means that main door is hinged on the right and the control panel is on the left.



RIGHT HAND

All reference to LEFT HAND ovens means that main door is hinged on the left and the control panel is on the left.

1.0 INTRODUCTION

The **MONO MX** rotary rack oven is a compact, gas-fired oven with a touchscreen control panel. The standard version of the MXTG oven accommodates a single **rotating rack** of up to eighteen trays capacity. Versions of the MXTG oven with a rack turntable option support a **standard rack**.

Eco-touch ovens are supplied with **TOUCH** displays for the user-friendly control panels. This can show pictures of product types or program numbers that have been set by the user. When not being used, the screen can show your company logo.

A voice-prompt facility is also available for the basic instructions like “Bake over.”



ECOTOUCH SCREEN CONTROLS



The stainless steel construction of the oven has easily cleaned interior and exterior surfaces and a bright appearance. The fan and rack rotator have generously rated, totally enclosed motors and a sealed-for-life gearbox.

The high-speed fan, heating and steam systems give efficient air circulation to produce a professional bake across a range of products via a diagonal cross-flow system with efficient air circulation. The steam system is connected to a standard water supply.

Steam is generated within the oven chamber by means of a multi-point, water injection cascade. The amount of steam to be generated is controlled by means of a programmable time period on the control panel. No drain is required for the baking and steaming process of this oven.

Programmed damper control is provided as part of the programming controls.

The oven door incorporates a large glass panel and LED lights to afford an excellent view of the baking progress. To optimise bakery layout the main oven door can be hinged on either side; even if oven is relocated after initial installation.

2.0 OVERALL DIMENSIONS

Figure 1: Dimensions for models FG166-G11LH** and FG166-G11RH**

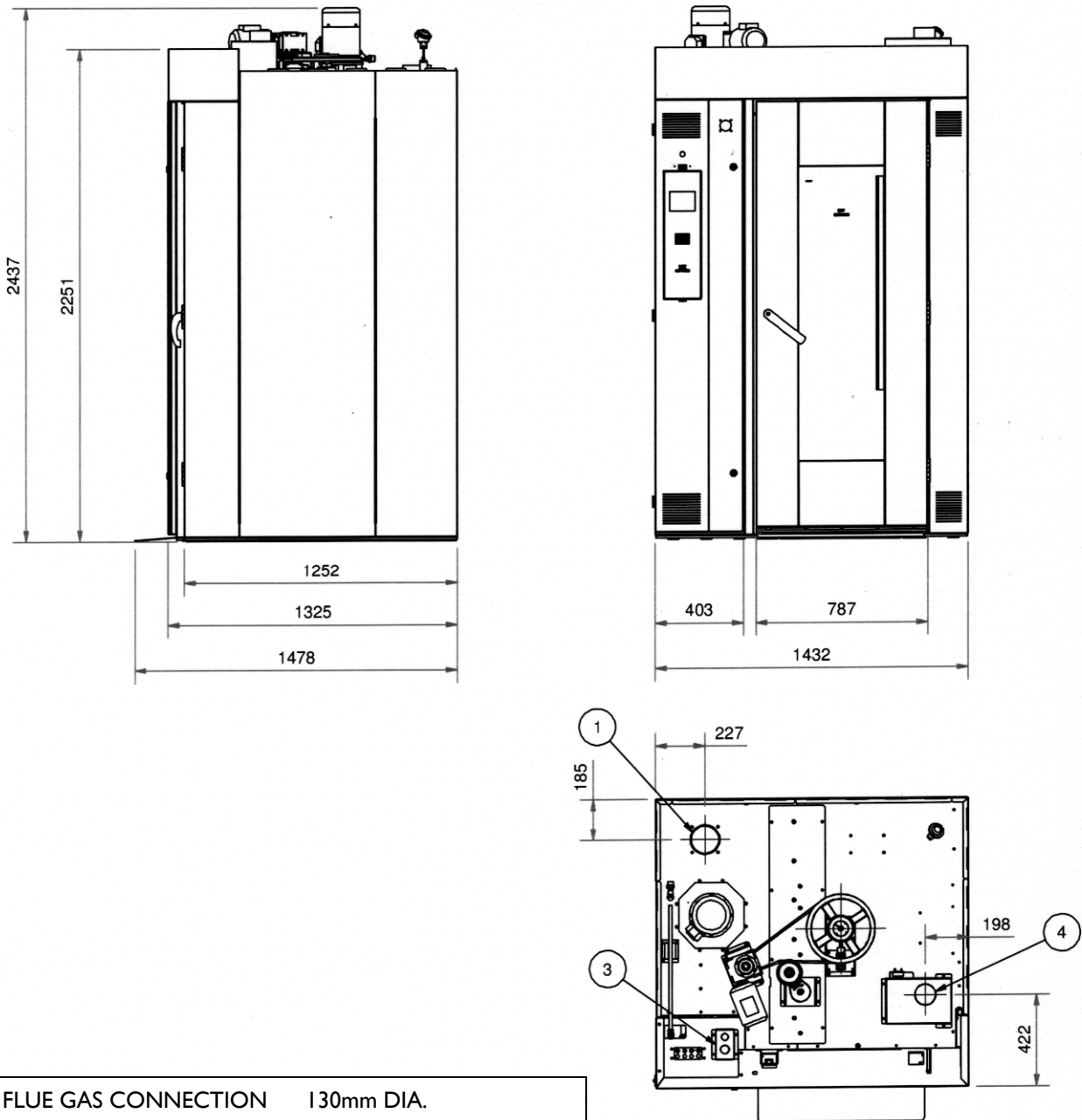

- 1. FLUE GAS CONNECTION 130mm DIA.
- 2. WATER CONNECTION 3/4-inch BSP
- 3. POWER CABLE INLET
- 4. STEAM DIVERTER BOX CONNECTION 100mm DIA.

MAX. RACK DIAGONAL = 885mm
 DOOR SWING RADIUS = 790mm

3.0 SPECIFICATIONS

Product

Designation: Oven
 Classification: Category 1_{2H} Type B₂₃

Electrical



Warning

The supply to this oven **must be protected** by a 30mA Type A Residual Current Device (RCD).

Power supply: 400 Vac, three phase, Earth and Neutral, 50 Hz
 1.9 kW, 8 amps per phase.

Connection point: See the Power Cable Inlet in **Figure 1**.

Mechanical

Overall dimensions: See **Figure 1** for width, depth, and height.

Maximum tray size: 762 mm x 457 mm (30 in. x 18 in.)

Air circulation: Radial fan driven by an electric powered motor.

Steam system: Mass energy storage, no drain

Rack rotation: Single electric-powered motor/gearbox driven via a belt drive.
 Hanger inside the baking chamber.

Rack turntable fitted to selected models (FG166-G****TT), compatible with a range of standard racks. Contact Mono Equipment to check compatibility.

Materials

No materials containing asbestos have been used in the construction of this oven.

Gas system

Fuel: Natural gas (G20)
 Operating pressure: 20mbar
 Rated output, high: 50 kW
 Combustion air: 50 m³/h (approximately)
 Burner inlet connection: See **Figure 1**.

Gas connection

Mono MXTG ovens are supplied with a two-stage bespoke burner that is set-up prior to dispatch. The burner is suitable for use with natural gas only. (See Specifications for other details).

Heat output	Gas pressure at connection point	Gas flow with burner in operation
50 kW	20.0 mbar	5.16 m ³ /h



Warning

- Burner installation and start-up should be carried out by an authorized technician. Local regulations for gas installations must be followed.
- Always check the nameplate for the gas type.
Do not use the burner with other gas types.
- Repairs and maintenance to be carried out by an authorised service engineer.

Flue gas connection

Connection on oven: Outside diameter Ø130 mm

Draft conditions: There must be a negative pressure of 1 to 5 mm WG in the combustion chamber. If the pressure is higher than 0 mm WG in service, a flue gas fan must be installed.

Temperature: The gas exhaust flue must be capable of withstanding a temperature of at least 400 °C.

Heat output	Flue gas temperature	Flue gas quantity
50 kW	400 °C	150 m ³ /h

Note: None of the flue gas ducts should slope downwards or be horizontal (if no flue gas fan is installed). The slope must be upwards towards the chimney. Avoid too many sharp elbows.

Initial burning-off procedure

All ovens undergo the burn-off procedure in the factory before being dispatched.

Flue system

Flue connection: See section - *Dimensions*.

Rack rotation

The rack hanger is driven by an electric motor situated on the mid left-hand side of the oven roof. Power transmission to the rack-hanger's central drive shaft is by means of a single tensioned V-belt that affords slippage of the transmission in the event of a blockage to rack rotation.

A rack turntable option is fitted to selected models (FG166-G****TT), allowing the use of a range of standard racks in the MONO MXTG oven.

Air circulation system

An electrically powered radial fan re-circulates air within the oven. Heated air enters the fan at the upper left-hand side of the oven and is driven within the roof structure to the vertically orientated air door at the rear corner of the baking chamber. Adjustable openings in the air door allow the amount of air entering the baking chamber at various heights to be adjusted to get the optimum baking result.

The air door openings are set at the factory and should not require resetting. The factory settings are given in section – *Setting the Air Slots* for reference. Should these factory setting fail to give a satisfactory baking performance then instructions for adjusting the openings are given.

Steam system

The steam generating system is completely contained within the oven and situated at its left hand side in the lowermost region of the air duct, outside of the baking chamber. Only cold water, at a pressure of 2 bar (29 PSI) – 4 bar (58 PSI), needs to be connected to the oven for the purpose of steam generation, domestic pressure is usually within this parameter.

The pressure reducing valve on the oven is factory set at 1.5 bar (22 PSI).

From a cold oven start the steam system will typically require 30 minutes to accumulate sufficient energy to produce satisfactory steaming performance; and during repeated baking cycles it automatically re-energises itself during the bake cycle. No drain is required for the steam system. Under normal conditions of use this oven is not considered a pressure vessel.

Gas Heating System

The gas heating system consists of the gas supply pipework, a pre-mix burner, air-to-air heat exchanger and flue outlet.

The gas burner is factory-fitted and must be connected to a natural gas fuel supply only. Every burner is pre-set and no adjustment should be attempted. Gas is mixed with air supplied from the room the appliance is situated in and burned to produce hot gaseous products of combustion that flow through the internal passages of the heat exchanger and are kept separated from the oven's re-circulating air.

Heat is transferred to the baking chamber through the interaction of re-circulating air passing over the hot surfaces of the heat exchanger.

After passing through the heat exchanger the products of combustion discharge from the oven through the flue outlet terminating at roof level towards the rear left side of the oven. This oven is intended to be connected to a flue in accordance with the specification and local authority guidelines.

Electrical connection

The oven is fitted with built-in automatic fuses, situated in the uppermost region of the compartment behind the control door. The fuses are marked and can be accessed when the control door is opened.

Ventilation

To ensure the correct operation of the roof-mounted components the ambient temperature should not exceed 50 °C. The oven requires zero clearance on left, right and rear vertical faces for operation or maintenance.

Extraction

Airborne emissions from the baking process, such as steam, oil, etc., will be discharged from the overpressure duct and the damper duct; both situated at roof level towards the front of the oven. Discharge will also occur from the front of the oven upon opening the door at the end of a bake. See also section – *Installation*.



Noise

Emission of airborne noise is less than 70 dB.

4.0 SAFETY

In the interest of safety and efficient operation of the oven, it is essential that this manual should be made available to the operator before work is commenced.

The following points should be observed and followed at all times.

1. This oven is designed for baking bread, confectionery and savoury bakery products. Do not use it for other items without consulting with **MONO**.
2. This appliance is not intended for outdoor use.
3. This appliance is not intended for residential use.
4. It is essential for proper and safe operation of the oven that users are familiar with its operation and use. *Read the instructions provided in this document before use.*
5. EVERY OVEN INSTALLATION MUST BE APPROVED BY THE LOCAL AUTHORITY
 *Neither the manufacturer, nor the vendors are liable in respect of accidents or damage where the purchaser/installer has not obtained such approval.*
6. Connection of the oven to the local gas supply is the responsibility of the installer, who should be a "Gas Safe" registered engineer using components that conform to the current industry standards.
7. It is the responsibility of the installer to ensure that an adequate supply of combustion air to the oven (see *Specifications* section for details) and the evacuation of combustion products are permanently in place.
8. An emergency isolation valve must be fitted in the gas supply and be well marked and accessible to operators.
9. No change is permitted to the gas group or family from that which is specified for this oven.
10. Parts of the oven that are protected by paint are not to be adjusted.
Do not adjust these parts.
11. Unauthorised service or repairs to these ovens may cause personal injury or damage to the equipment, which may invalidate warranty agreements.
12. Only qualified engineers appointed by MONO EQUIPMENT should carry out service and repairs to this equipment.
-  13. Electrical panels and electrical distributor boxes should not be opened until the main supply to the oven has been turned off.
14. When choosing and installing a flue, the precautions and instructions in this manual must be observed.

15. All connections to this oven must be made in accordance with the statutory and technical regulations of the country in which the oven is installed.



16. When work is being carried out inside the oven, the electrical mains isolator must be turned off and locked.



17. Whenever there is someone working inside the oven, the baking compartment door should be wedged open and a suitable warning notice hung on the door to prevent it being accidentally closed.



18. While the oven is in operation, and for some time after having been in operation, it is dangerous to touch the window glass or the metal surfaces in its vicinity. The oven must be allowed to cool before any form of cleaning is started.

19. Use only **MONO** spare parts for this oven.

20. The construction of the oven must not be changed.

21. Customers operating this oven in a hard water area must ensure that an efficient water-softening device protects the water supply to the equipment.

22. Oven gloves should be worn when moving products in or out of the oven.

23. The owner of the oven is **legally obliged to instruct staff** using the oven in its operation and in these safety regulations. The instruction manual for the oven must not be removed from the oven work area.



WARNING: WHEN DOING ANY MAINTENANCE ON TOP, KEEP CLEAR OF THE RECTANGULAR FLUE PIPE TOWARDS THE FRONT RIGHT HAND SIDE OF THE ROOF. VERY HOT AIR IS EJECTED.

24. Moving parts remain unguarded on the oven roof as this area is out of reach of the operator and therefore deemed safe. Care must be taken to avoid these motorised parts when maintenance tasks are performed.

25. Unless trays/containers for the purpose of holding the oven products are supplied with the oven by the manufacturer, it is the responsibility of the customer to ensure that the nature and surface conditions of materials likely to come into contact with food shall be such that they cannot contaminate or spoil the food.

26. This appliance is only for professional use and must be used by qualified people.

27. Up until August 2017 the oven's main door has a safety release foot-plate on its inner side allowing the door to be opened from inside in an emergency lock-in situation.

EMERGENCY INTERNAL-DOOR RELEASE

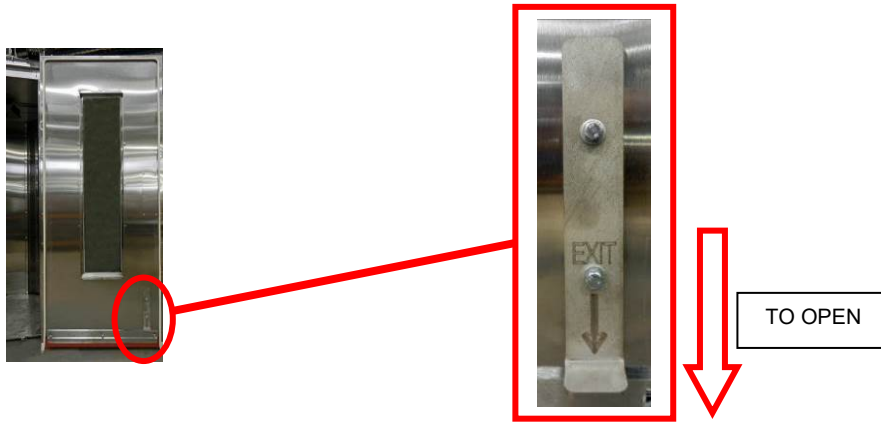

- After August 2017 the oven's main door has a safety release handle on its inner side allowing the door to be opened from inside in an emergency lock-in situation.

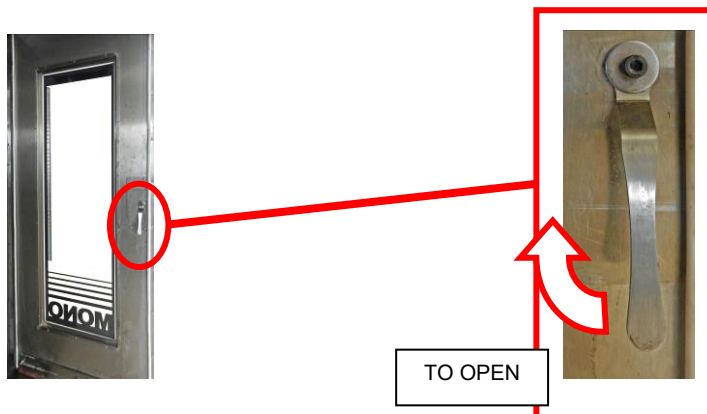

5.0 INSTALLATION

1. The **MONO MXTg** oven is designed to operate as a freestanding unit, and must not be bolted down or fixed to the floor in any way.
2. The concrete floor beneath the oven must be smooth, flat and clear of any obstructions, and must be at least 150mm (6") thick.
3. The foundation must be flush with the overall bakery floor because racks are wheeled up a ramp (supplied with the oven) into the baking chamber.
4. A minimum headroom clearance of 3 metres (180") between the floor and the bakery ceiling must be maintained at all times. A minimum clearance of 100mm (4") is to be maintained between bakery walls and oven rear and sides.
Ovens may be installed next to each other without clearance between them.

5. WATER SUPPLY

The water supply to the oven shall be fitted with protective means against backflow in the water supply and installed according to the national regulations in force. Minimum pressure should be 2 bar – 4 bar.

Domestic pressure is usually within this parameter.

Customers in hard water areas must ensure that an efficient water treatment device protects the supply to the oven. It is the customers' responsibility to install and maintain an adequate water supply to the oven, which should comply with local water regulations.

Connect to a suitable water supply, making sure that the pipes are flushed out to remove all foreign bodies i.e. flux or solder.

NOTE

Set up of the pressure regulator should not be required as it is factory set to the optimum setting 1.5 bar to provide the best steam during a bake.

6. Pipework from the gas supply to the oven shall be arranged so as to not require removal of the burner for routine maintenance tasks.
7. Parts of the oven that are protected by paint are not to be adjusted.
Do not adjust these parts.
8. Pipework connections shall be achieved either by threaded joints conforming to EN10226-1 (taper-parallel threads) or EN10226-2 (taper-taper threads), each sealed with compound or tape suitable for the gas specified for this oven, or by compression fittings.

OVEN EVACUATION

It is recommended that evacuation of the oven baking chamber products is achieved with a hood covering the entire oven top and projecting beyond the front of the oven by 600 mm. the extraction rate from the hood should be approximately 1700 m³/h.

The oven is a Type B appliance requiring an 8" flue to evacuate the products of combustion to the outside of the room containing the oven and the combustion air to be drawn from that room. The customer is responsible for providing adequate levels of make-up air.

GAS CONNECTION

Ovens will be supplied with a bespoke burner that will be set-up prior to dispatch.
The burner is suitable for use with natural gas only.

The burner output is 50 kW.

Heat output	Gas pressure at connection point	Gas flow with burner in operation
50 kW	20.0 mbar	5.16 m ³ /h



Warning

- Burner installation and start-up should be carried out by an authorized technician. Local regulations for gas installations must be followed.
- Always check the nameplate for the gas type.
Do not use the burner with other gas types.
- Repairs and maintenance to be carried out by an authorised service engineer.

Burner reset

The burner reset button is located above the control panel.
 After 3 failed attempts of igniting, the button will illuminate signalling that the burner has locked out.

To reset, press the button until the light goes out.

The burner will then attempt to ignite 3 more times.

If the burner continuously fails, contact a qualified gas engineer.

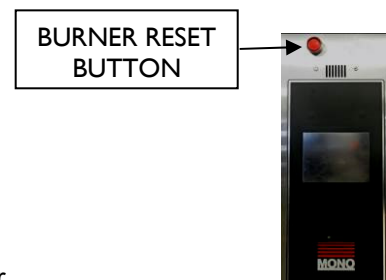

FLUE GAS CONNECTION

Connection on oven: Outside diameter Ø130 mm.

Draft Conditions: There must be a negative pressure of 1 to 5 mm WG in the combustion chamber. If the pressure is higher than 0mm WG in service, a flue gas fan must be installed.

Temperature: The gas exhaust flue must be capable of withstanding a temperature of at least 400 °C.

Heat output	Flue gas temperature	Flue gas quantity
50 kW	400 °C	150 m ³ /h

Note: None of the flue gas ducts should slope downwards or be horizontal (if no flue gas fan is installed). The slope must be upwards towards the chimney. Avoid too many sharp elbows

Initial burning-off procedure

All ovens undergo the burn-off procedure in the factory before being dispatched.

How to load the oven when a rack turntable is fitted (FG166-G****TT models only)



Caution

Surfaces on the oven will be hot – always wear protective gloves and appropriate clothing (including shoes).

1. Open the oven door.
2. Push the rack **(A)** into the oven until it reaches the back stops **(B)** on the turntable.
3. Close the oven door.

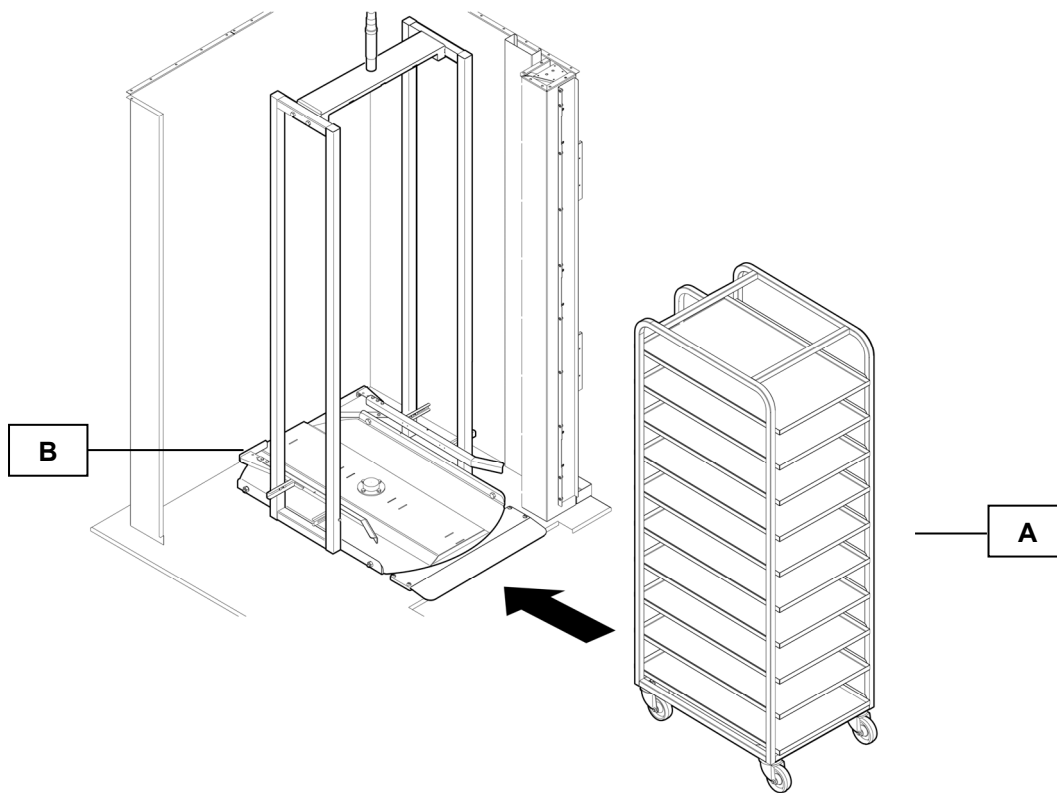

After baking is complete

1. Open the oven door.
2. Pull the rack out of the oven.
3. Close the oven door.

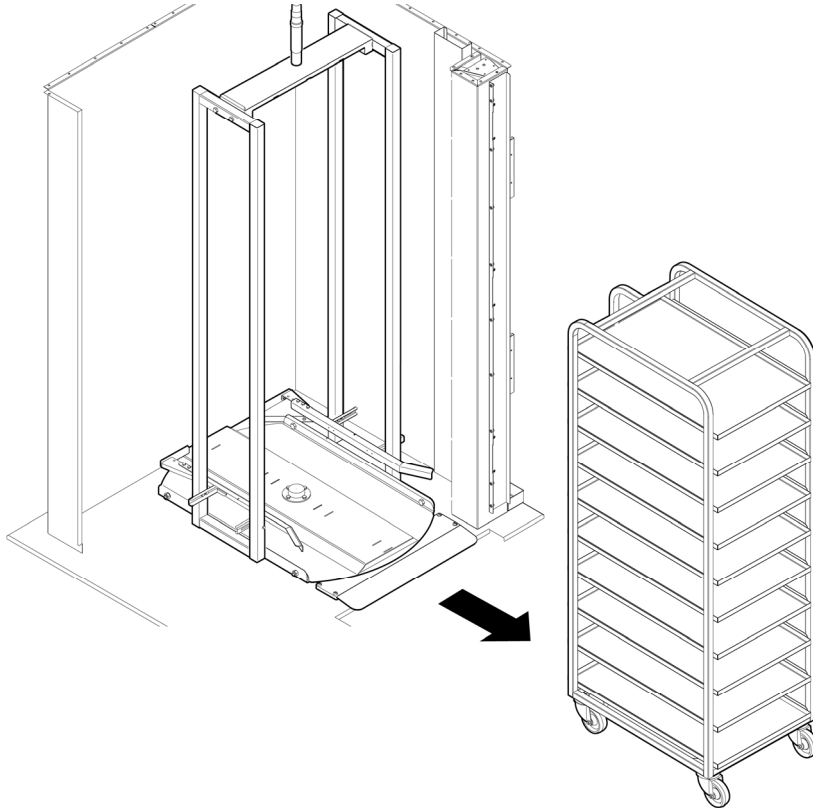

6.0 ISOLATION

In case of an emergency, switch the oven off at the mains electrical isolator switch and gas mains tap.



MAINS ELECTRICAL ISOLATOR SWITCH
On main control door.



NOTE:

AS SOME PARTS STAY ELECTRICALLY LIVE AFTER THE ISOLATOR SWITCH ABOVE IS OPERATED, ENSURE THE OVEN IS DISCONNECTED FROM THE CONSUMER POWER SUPPLY (MAINS) IF WORKING ON THE ELECTRICAL BOX AND PANEL.



TYPICAL GAS ISOLATING VALVE
Installed near oven.

7.0 CLEANING INSTRUCTIONS



Caution

Do not use high-pressure equipment to clean the oven.

The oven design uses sealed components wherever possible. A minimal amount of routine cleaning is required. However, it is essential for cleaning to be regularly and adequately done.

1. Sweep out debris from the oven floor daily.
2. Clean up spillages of product on the oven floor.
3. Wipe off splashes on the door window.

Do not use alkaline or abrasive detergents when cleaning the oven.

Do not use detergents on the control panel overlay – wipe with a damp cloth only.

Note

A buildup of spillages may result from incorrectly placed racks. Also, check for damage to door seals, particularly if operators are careless with rack handling.

GAS BURNER

For cleaning, service, and maintenance of the burner, please contact an authorised expert company.

8.0 GENERAL MAINTENANCE



WARNING

- This appliance must be maintained at regular intervals. The frequency of maintenance will depend upon your specific use and location. The maximum service interval should be 12 months.
 - Service and maintenance should only be undertaken by suitably qualified, trained, and competent engineers.
 - You must immediately report any damage or defect arising with the appliance.
 - Unsafe equipment is dangerous. Do not use the appliance. Isolate the power supply and contact MONO or your appointed service agent.
-

To maintain the warranty conditions, the oven must undergo service at specific intervals. Below is the service program with the given intervals:

Maintenance every 3 months

Lubrication:

Door lock – use heat-resistant grease

Maintenance every 12 months

Check/adjust:

Door lock mechanism
 Internal door release mechanism
 Lighting, including cables
 Damper function
 Drive belt tension
 Limit positions
 Water connection tightness
 Solenoid valve operation
 Rack hanger bearing
 Function check
 Chamber temperature calibration

Gas heated oven

Servicing of the gas burner, heat exchanger, and flue should be carried out at least once every 12 months by a suitably qualified person.

Lighting

If the lighting in the door fails to operate, contact the Mono Service Department. It cannot be replaced by the user.



Section 9

TOUCH SCREEN OPERATING INSTRUCTIONS

BASIC OPERATION

ALL OPERATIONS ARE ACTIVATED BY TOUCHING AREAS ON THE SCREEN, WHICH WILL PASS YOU ON TO THE NEXT INFORMATION PANEL.

DO NOT USE EXCESSIVE FORCE.

(THE PRESSURE REQUIRED TO OPERATE THE PANEL CAN BE ALTERED IN THE SETTINGS SECTION)

TOUCH THE SCREEN ON THE AREA YOU REQUIRE TO ACTIVATE

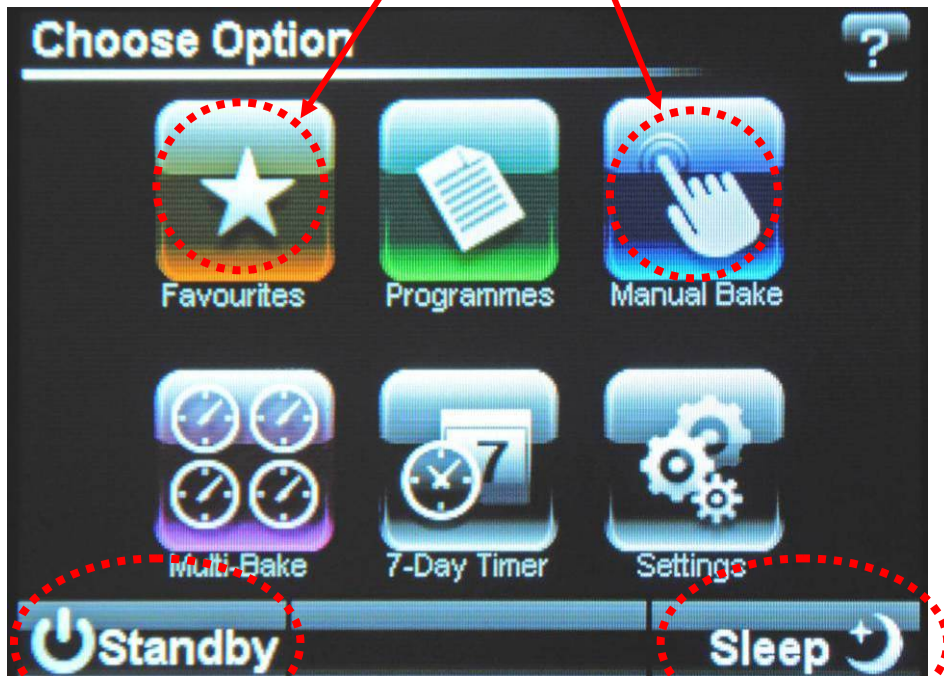

STANDBY
THE OVEN TURNS OFF.
TOUCH THE SCREEN TO GO TO THE OPTION SCREEN.

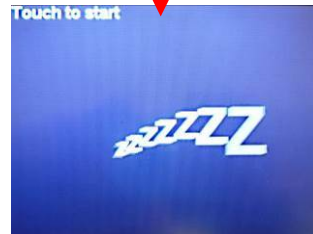

SLEEP
THE OVEN STAYS AT 100c AND HEATS TO LAST PROGRAM TEMPERATURE WHEN THE SCREEN IS TOUCHED.

9 -1 BAKING USING FAVOURITES MENU

TOUCH TO OPEN THE FAVOURITES SELECT SCREEN

1



OPTION SCREEN

TOUCH THE NAME OF THE PRODUCT REQUIRED

2



SELECT SCREEN

TOUCH THE "FULL LOAD" OR "HALF LOAD" AS REQUIRED

3

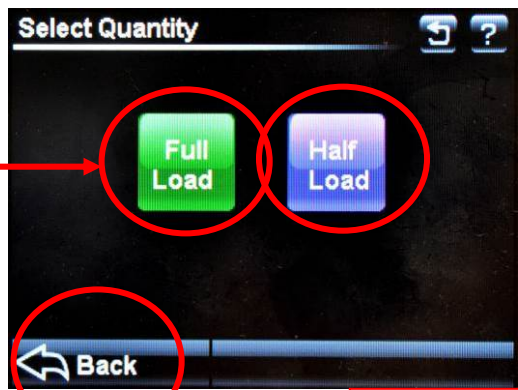

LOAD SCREEN

TO RETURN TO THE PREVIOUS SCREEN TOUCH THE "BACK" BUTTON AT ANY TIME

IF THE OVEN IS NOT UP TO TEMPERATURE IT WILL SHOW THE HEATING SCREEN.

WAIT FOR THE OVEN TO REACH TEMPERATURE

IF THE OVEN IS TOO HOT FOR THE TEMPERATURE CHOSEN, THE SCREEN WILL TELL YOU TO OPEN THE DOOR TO AID COOLING.

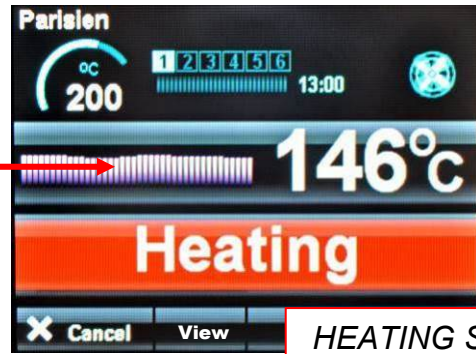

HEATING SCREEN

WHEN OVEN IS AT THE CORRECT TEMPERATURE THE "READY" SCREEN WILL SHOW.

1. OPEN DOOR AND LOAD PRODUCT.
2. CLOSE THE DOOR FULLY.
3. TOUCH "START"

TIP
TO HELP TO KEEP THE OVEN HOT, TRY NOT TO KEEP THE DOOR OPEN MORE THAN NEEDED

4



READY SCREEN

BAKE IN PROGRESS SCREEN

THIS SCREEN WILL SHOW WHILE THE PRODUCT IS BAKING

BAKE PHASE (WHEN USED)

ACTUAL OVEN TEMPERATURE

SET TEMPERATURE

TEMPERATURE PROFILE BAR

BAKE TIME PROGRESS BAR

NOTE
The actual temperature shown will rise and fall above and below the set temperature as the oven cools and reheats. This is not a fault



BAKE TIME LEFT

BAKE OVER SCREEN

5

AT THE END OF THE BAKE TIME A SOUNDER WILL BE HEARD AND "BAKE OVER" WILL FLASH. TOUCH "**STOP**" AND OPEN THE DOOR TO REMOVE THE PRODUCT.

TO KEEP THE OVEN BAKING FOR EXTRA MINUTES THE "+ 10 MIN" BUTTON CAN BE TOUCHED. (THIS TIME CAN BE ALTERED IN SET UP)

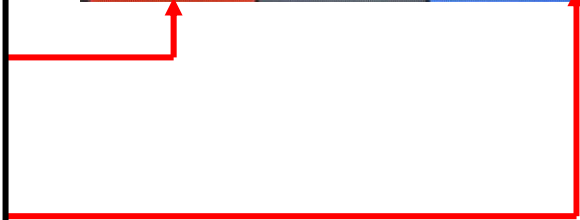

TOUCHING "VIEW" BUTTON DURING A BAKE

TOUCHING "**VIEW**" BUTTON DURING A BAKE WILL SHOW THE SETTINGS FOR THE BAKE IN PROGRESS. TOUCH "**CANCEL**" TO GO BACK TO THE PREVIOUS SCREEN.

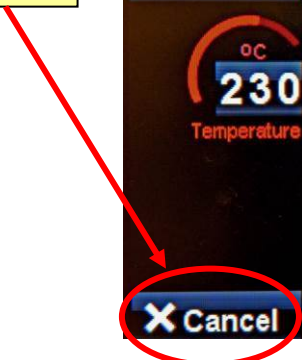
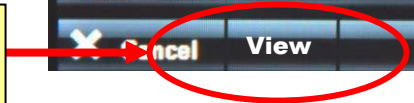

VIEW SCREEN

9 - 2 BAKING USING MANUAL MENU

TOUCH TO OPEN
MANUAL BAKE
SCREEN



OPTION SCREEN

SET BAKE TIME AND TEMPERATURE



MANUAL BAKE SCREEN

SET BAKE TEMPERATURE
TOUCH TEMPERATURE ON THE
SCREEN TO ACTIVATE THE
KEYBOARD SCREEN.
KEY IN REQUIRED TEMPERATURE

2



SET BAKE TIME
TOUCH TIME ON THE SCREEN TO
ACTIVATE THE KEYBOARD SCREEN.
KEY IN REQUIRED TIME AND
TOUCH "DONE"

3

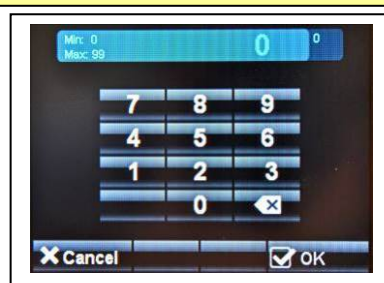

NOTE:

TIME DOES NOT HAVE TO BE SET IN MANUAL MODE. (ONLY TEMPERATURE)
WHEN START IS PRESSED, THE TIME WILL COUNT UP INSTEAD OF DOWN.
TOUCH STOP TO FINISH THE BAKE.

USE STEAM TIME AND DAMPER IF REQUIRED

STEAM **4**
 TOUCH AND HOLD FOR THE TIME (SECONDS) STEAM IS REQUIRED. (THIS CAN BE USED BEFORE OR DURING THE BAKE)

DAMPER **5**
 TOUCH TO OPEN THE DAMPER. (SYMBOL IS GREEN)
 TOUCH TO CLOSE THE DAMPER. (SYMBOL IS RED)



MANUAL BAKE SCREEN 2

CANCEL
 TOUCH AT ANYTIME TO GO BACK TO THE SETTING SCREEN.

START **6**
 TOUCH "START" TO START BAKE



STOP **7**
 TOUCH "STOP" WHEN END OF BAKE BUZZER SOUNDS OR WHEN REQUIRED IF NO TIME WAS ENTERED

SAVE MANUAL PROGRAM, IF REQUIRED



MANUAL BAKE SCREEN 3

SAVE SETTINGS
 IF NO TIME WAS ENTERED AT THE START OF THE BAKE, WHEN STOP IS TOUCHED "SAVE" WILL APPEAR AT THE BOTTOM OF THE SCREEN. "SAVE" CAN BE TOUCHED AND AN OPTION SCREEN WILL APPEAR.

7

TOUCH "ADD TO FAVOURITES" OR "SAVE AS"

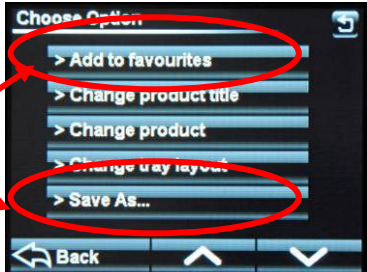

USE KEYBOARD TO TYPE THE REQUIRED NAME AND TOUCH "SAVE"



NOTE: In manual mode, only one operation of the steam or damper is saved.

9 - 3 BAKING USING PROGRAMMES MENU

NOTE : THIS COVERS TWO VERSIONS OF FIRMWARE. (THE OVEN CAN BE PRE-SET TO SHOW ONLY ONE OF THEM).
 1. **PICTORIAL** VERSION SHOWS CHOICES OF PRODUCT CATERGORIES
 2. **NUMERICAL** VERSION SHOWS RANGES OF PROGRAM NUMBERS.

TOUCH TO OPEN
 "CATEGORY" or
 "PROGRAM CHOICE"
 SCREEN



OPTION SCREEN

TOUCH THE TYPE OF
 PRODUCT OR PROGRAM
 RANGE CHOICE WANTED
 AND "SELECT" SCREEN
 OPENS

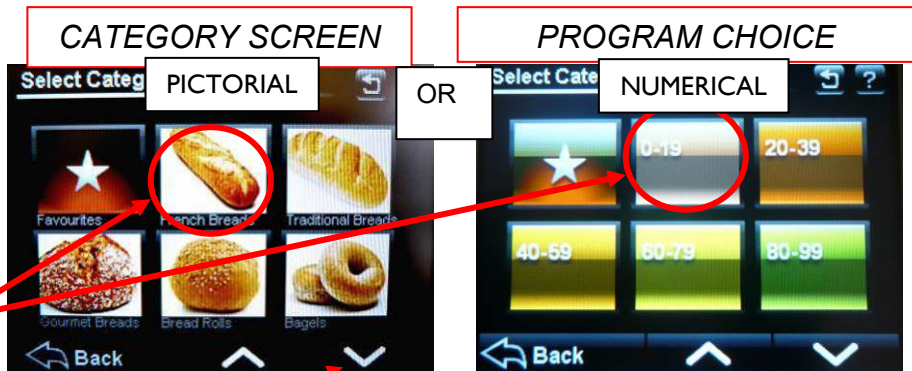

MORE

TOUCH THE
 NAME OR NUMBER OF
 THE PRODUCT
 REQUIRED

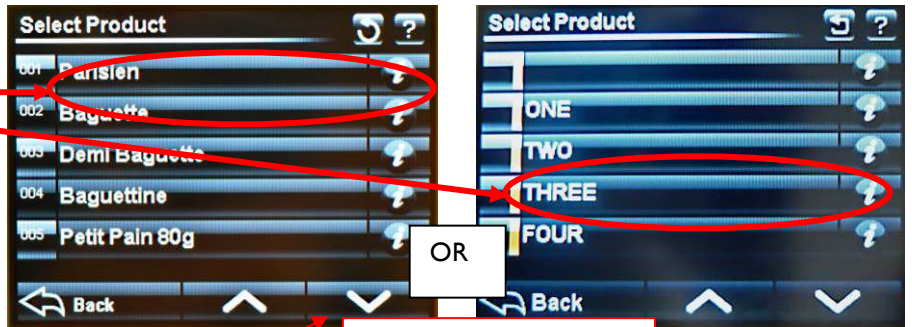

SCROLL DOWN FOR MORE PRODUCTS IF AVAILABLE

SELECT SCREEN

TOUCH THE
 "FULL LOAD" OR
 "HALF LOAD" AS
 REQUIRED



LOAD SCREEN

TOUCH THE "BACK"
 BUTTON AT ANY TIME
 TO RETURN TO THE
 PREVIOUS SCREEN

IF THE OVEN IS NOT UP TO TEMPERATURE IT WILL SHOW THE HEATING SCREEN.

WAIT FOR THE OVEN TO REACH TEMPERATURE

IF THE OVEN IS TOO HOT FOR THE TEMPERATURE CHOSEN, THE SCREEN WILL TELL YOU TO OPEN THE DOOR TO AID COOLING.

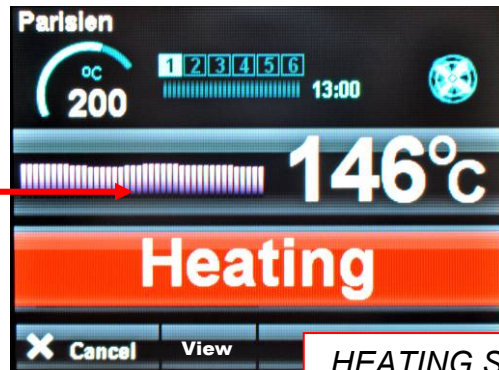

HEATING SCREEN

5

WHEN THE OVEN IS AT THE CORRECT TEMPERATURE, THE "READY" SCREEN WILL SHOW.

1. OPEN DOOR AND LOAD PRODUCT.
2. CLOSE THE DOOR FULLY.
3. TOUCH "START"

TIP
TO HELP TO KEEP THE OVEN HOT, TRY NOT TO KEEP THE DOOR OPEN MORE THAN NEEDED

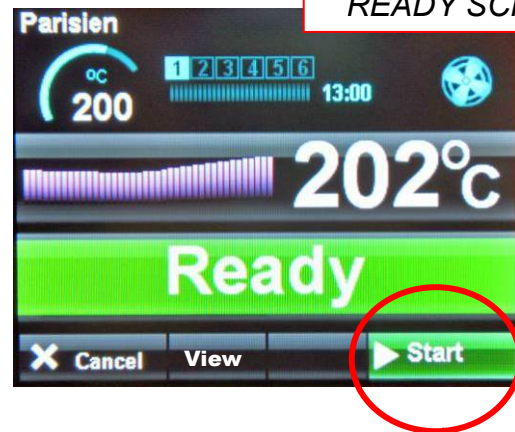

READY SCREEN

THIS SCREEN WILL SHOW WHILE THE PRODUCT IS BAKING

BAKE PHASE (WHEN USED)

ACTUAL OVEN TEMPERATURE

SET TEMPERATURE

TEMPERATURE PROFILE BAR

BAKE TIME PROGRESS BAR

NOTE
The actual temperature shown will rise and fall above and below the set temperature as the oven cools and reheats. This is not a fault



BAKE TIME LEFT

BAKE OVER SCREEN

6

AT THE END OF THE BAKE TIME A SOUNDER WILL BE HEARD AND "BAKE OVER" WILL FLASH. TOUCH "STOP" AND OPEN THE DOOR TO REMOVE THE PRODUCT.

TO KEEP THE OVEN BAKING FOR EXTRA MINUTES THE "+ 10 MIN" BUTTON CAN BE TOUCHED. (THIS TIME CAN BE ALTERED IN SET UP)



TOUCHING "VIEW" BUTTON DURING BAKE

TOUCHING "VIEW" BUTTON DURING BAKE WILL SHOW THE SETTINGS FOR THE BAKE IN PROGRESS. TOUCH "CANCEL" TO GO BACK TO THE PREVIOUS SCREEN.



VIEW SCREEN

9 - 4 CREATING A PROGRAM

TOUCH TO OPEN
"CATEGORY"
SCREEN

1



OPTION SCREEN

TOUCH THE TYPE
OF PRODUCT
WANTED AND THE
"SELECT" SCREEN
OPENS

2



CATEGORY SCREEN



SELECT SCREEN

TOUCH THE DOWN ARROW
UNTIL A BLANK PROGRAM
IS REACHED.

3

TOUCH "1" BUTTON
NEXT TO THE BLANK
PROGRAM TO OPEN
NEXT SCREEN

4

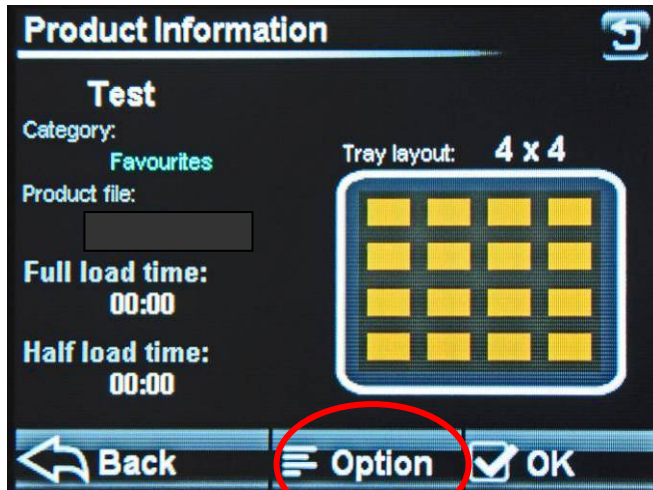

INFORMATION SCREEN

TOUCH OPTION TO GO TO PASS CODE SCREEN **5**

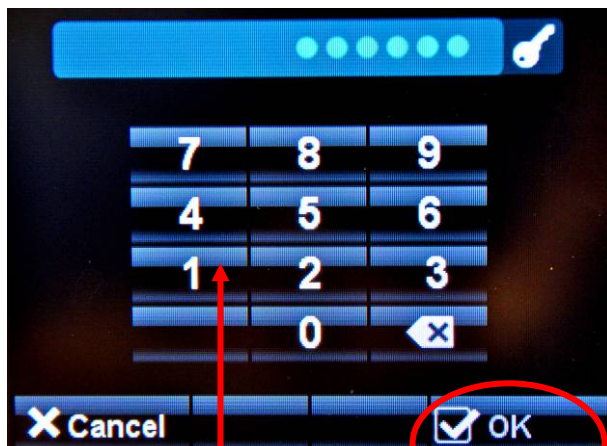

PASS CODE SCREEN

ENTER "SUPERVISOR" PASS CODE AND THEN TOUCH OK.
(DEFAULT CODE = 123456) **6**

CHANGE PRODUCT

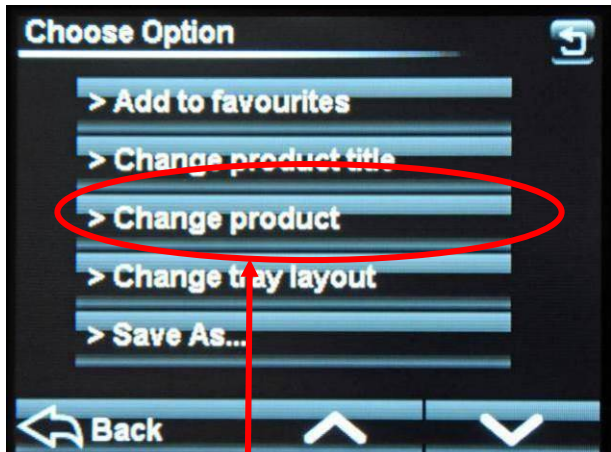

OPTION SCREEN

TOUCH "CHANGE PRODUCT" **7**

LOAD TYPE

VALUE CHANGE SCREEN

Full load 1 2 3 4 5 6

BAKE PHASE (IF REQUIRED)

INCREASE

OR USE KEYS

DECREASE

ENTER AMOUNT REQUIRED AND TOUCH DONE

POWER LEVEL

Cancel Save

TOUCH EACH ITEM AND CHANGE THE VALUE BY USING THE UP AND DOWN KEYS OR BY USING THE KEY PAD.

TOUCH "FULL LOAD" TO CHANGE TO "HALF LOAD" SETTINGS IF REQUIRED. TOUCH AGAIN TO GO BACK TO "FULL LOAD"

TOUCH "SAVE" WHEN SATISFIED WITH THE SETTINGS OF EACH LOAD TYPE.

8

CHANGE TRAY LAYOUT

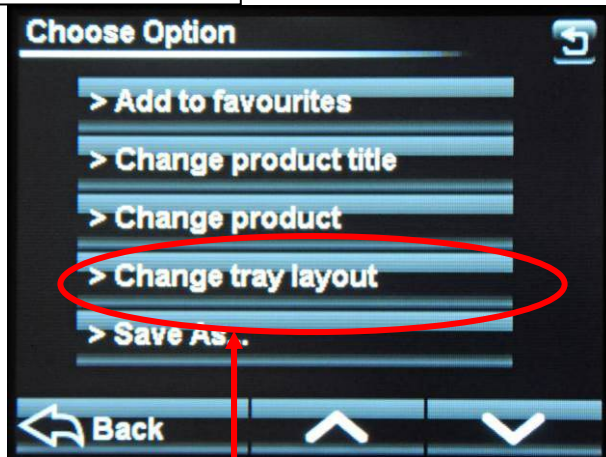

OPTION SCREEN

TOUCH "CHANGE TRAY LAYOUT"

9

TOUCH TO ADJUST
NUMBER OF PRODUCTS
ACROSS THE TRAY

TOUCH TO ADJUST
NUMBER OF PRODUCTS
DOWN THE TRAY

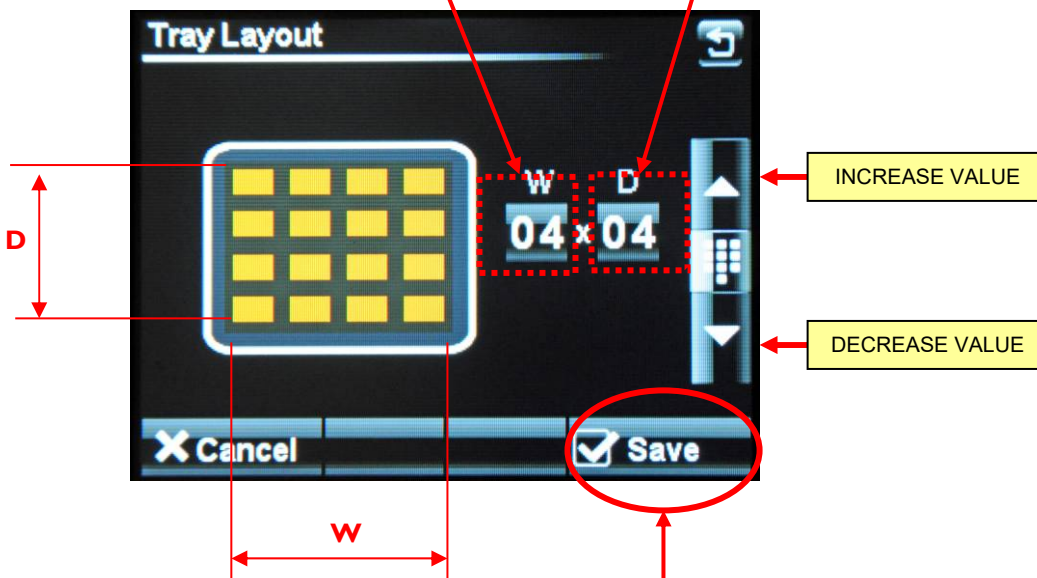

WHEN SATISFIED WITH THE TRAY
LAYOUT TOUCH SAVE TO RETURN TO
THE "OPTIONS" SCREEN

10

SAVE

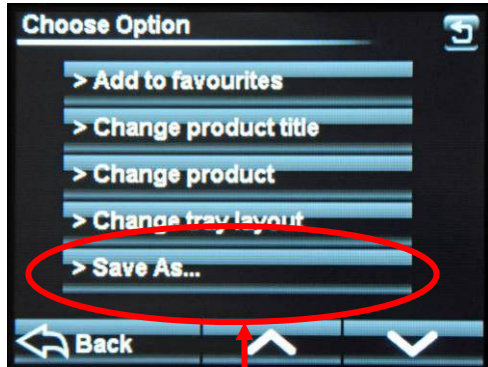

OPTION SCREEN

TOUCH "SAVE AS" 11

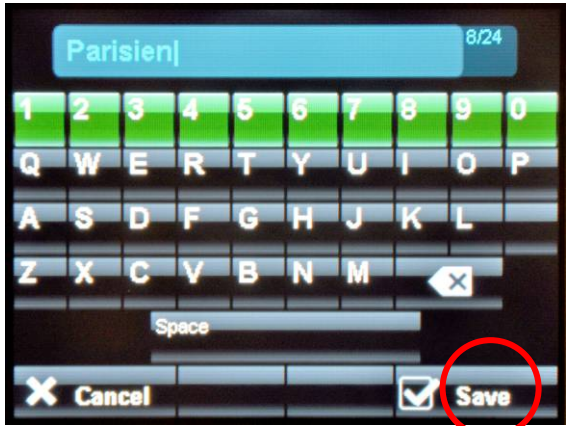

KEYBOARD SCREEN

TYPE IN THE NEW NAME AND TOUCH "SAVE" 12

ADD A PRODUCT TO THE FAVOURITES LIST



TOUCH THE TYPE OF PRODUCT WANTED AND THE "SELECT" SCREEN OPENS

CATEGORY SCREEN



TOUCH THE "i" (INFORMATION) BUTTON NEXT TO THE PRODUCT YOU WANT AS A FAVOURITE. THIS OPENS THE OPTION SCREEN

SELECT SCREEN

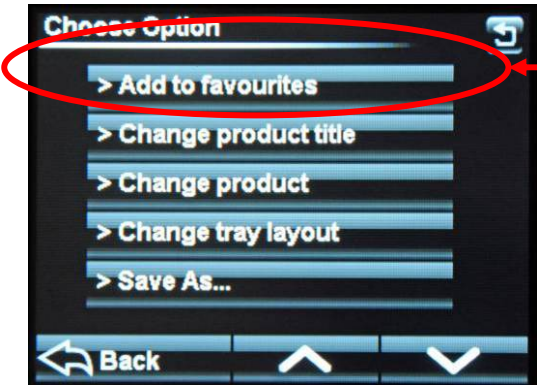

TOUCH "ADD TO FAVOURITES" THE PRODUCT WILL NOW SHOW ON THE FAVOURITES LIST

OPTION SCREEN

9 - 5 SETTING 7-DAY TIMER

TOUCH TO OPEN
"7-DAY TIMER"
SCREEN

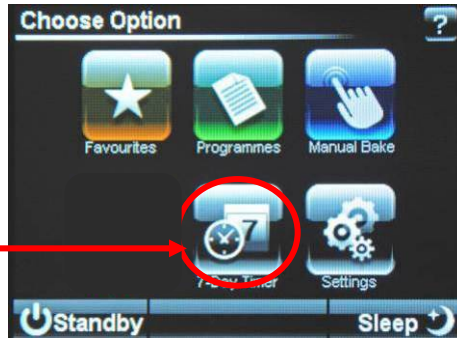

OPTION SCREEN

CHOOSE DAY

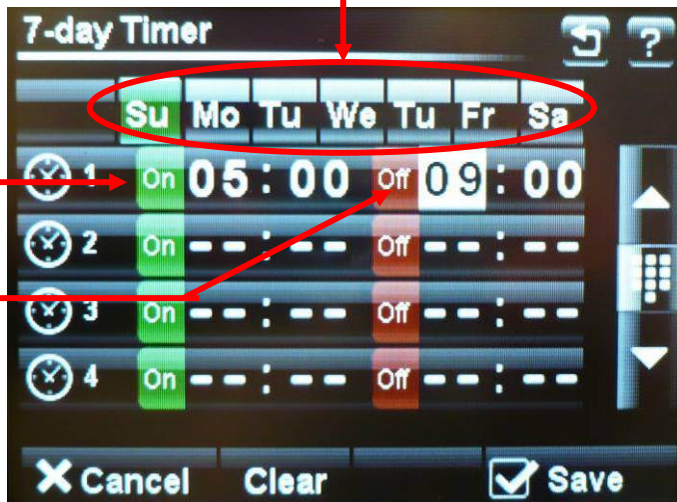

SET "ON" TIME

2

SET "OFF" TIME

4

INCREASE VALUE

3

DECREASE VALUE

TIMER SETUP SCREEN

NOTE
Up to four on/off times can be set for each day.
Touch "clear" to clear the settings on the day shown.
Touch "save" to activate the times set.

9 - 6 SETTINGS



OPTION SCREEN

TOUCH TO OPEN THE "SETTINGS" SCREEN



PASS CODE SCREEN

ENTER "SUPERVISOR" PASS CODE AND THEN PRESS OK. (DEFAULT CODE = 123456)

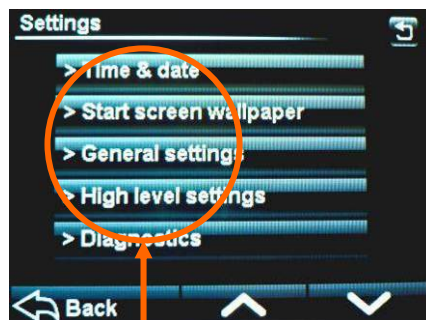

SETTINGS SCREEN

CHOOSE THE SETTING TO ALTER

2

TIME AND DATE

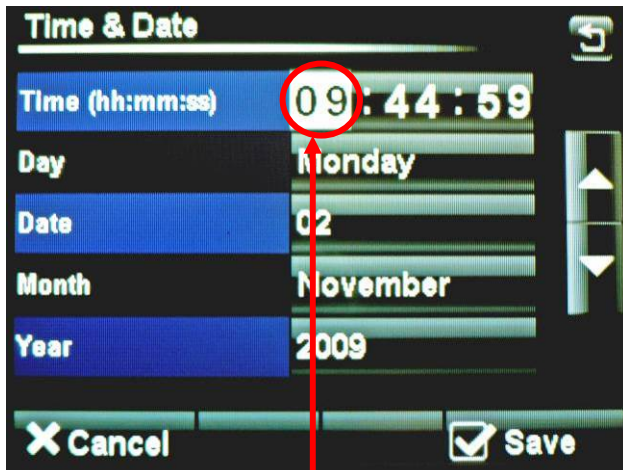

TOUCH THE SCREEN TO HIGHLIGHT THE ITEM TO CHANGE **1**

USE THE INCREASE / DECREASE BUTTONS TO ALTER THE SETTINGS **2**



TIME AND DATE SCREEN

WHEN ALL INFORMATION IS CORRECT, TOUCH "SAVE". THIS WILL RETURN TO THE SETTINGS SCREEN **3**

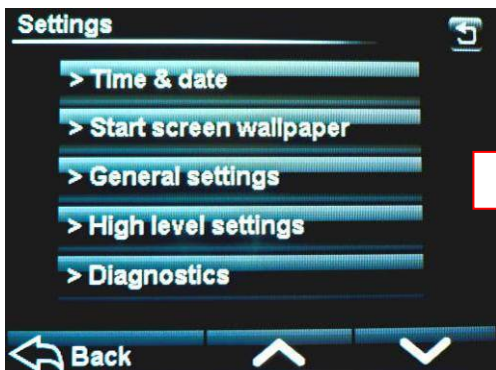

SETTINGS SCREEN

OVEN SETTINGS (GENERAL)

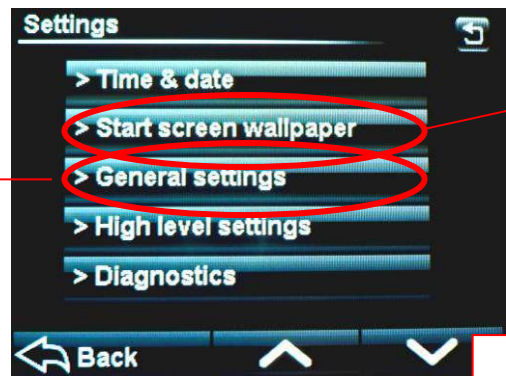

SETTINGS SCREEN

TOUCH "GENERAL SETTINGS" AND THE FOLLOWING SCREEN WILL APPEAR.

SCROLL DOWN TO MOVE THROUGH ALL CHOICES AND ADJUST EACH ONE AS REQUIRED, USING THE ARROW KEYS.

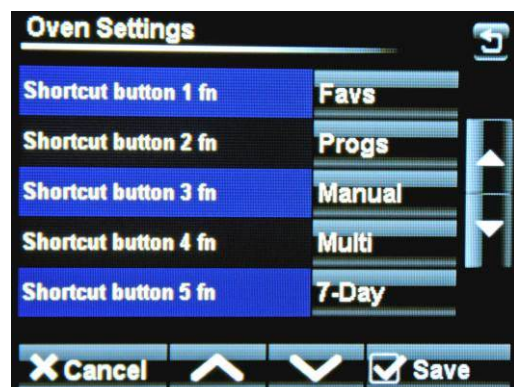
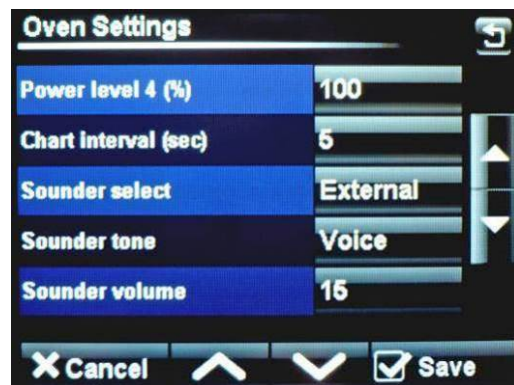
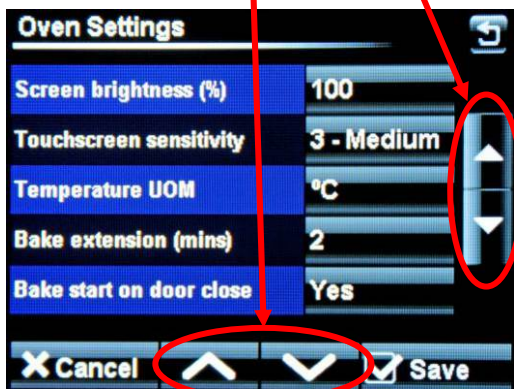

OVEN SETTINGS EXPLAINED - GENERAL LEVEL

SCREEN BRIGHTNESS –

Adjusts the brightness of the viewing screen for user comfort.

TOUCHSCREEN SENSITIVITY –

Adjusts the pressure required to operate the touch screen. (5 settings)

TEMPERATURE UNIT OF MEASURE –

Centigrade (Celsius) or Fahrenheit

BAKE EXTENSION (mins) –

Adjusts the extra time at the end of a bake for each “extra time” button touch. (10mins max)

BAKE START ON DOOR CLOSE –

This will start the set bake program as soon as the door closes.

SLEEP MODE DELAY –

Oven will go into sleep mode after the set minutes, providing it is up to temperature and has been through at least one bake cycle.

8 HOUR COUNTDOWN TIMER –

After 8 hours the oven gives a warning and then turns off.
Touch any button for an extra hour if required.

POWER LEVEL (1-4) –

Set these as required for each level to be used.

CHART INTERVAL –

Time interval in seconds that the bars show on the heat and bake time progress charts.

SOUNDER SELECT –

Set as external or onboard.

SOUNDER TONE –

Select a tone – Voice or Off

SOUNDER VOLUME –

Adjust to suit the volume required. (onboard sounder only)

SHORTCUT BUTTONS –

1 fn
2 fn
3 fn
4 fn
5 fn

Gives the choice of what buttons are active and in which order they appear on the options screen.

Options available = Favourites, Programs, Manual bake, Multi bake,
7-day timer . (Settings at **6fn** cannot be changed)

OVEN SETTINGS (HIGH LEVEL)



TOUCH "HIGH LEVEL SETTINGS" AND THE FOLLOWING SCREEN WILL APPEAR.

SETTINGS SCREEN



ENTER "HIGH LEVEL" PASS CODE AND THEN TOUCH OK.

2

THE FOLLOWING SCREEN WILL APPEAR.

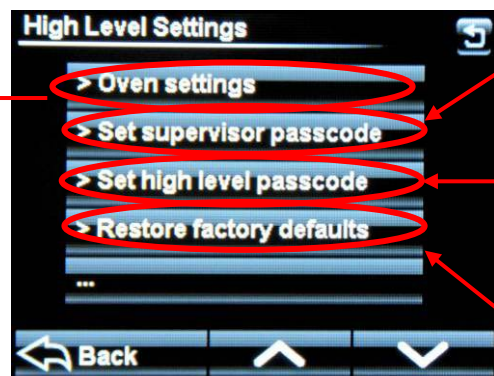

CHANGE SUPERVISOR PASSWORD HERE

CHANGE HIGH LEVEL PASSWORD HERE

RESTORES ALL SCREENS BACK TO ORIGINAL DEFAULT SETTINGS (NOT PASSCODES)

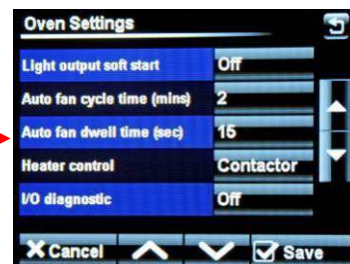
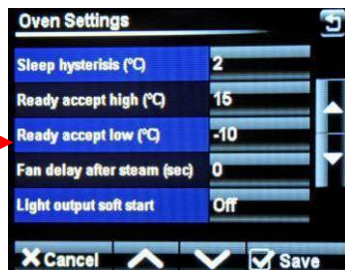
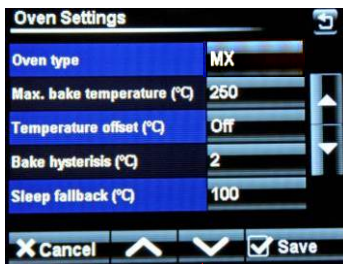

SCROLL DOWN TO MOVE THROUGH ALL CHOICES AND ADJUST EACH ONE AS REQUIRED, USING THE ARROW KEYS.

3

OVEN SETTINGS EXPLAINED - HIGH LEVEL

OVEN TYPE –

Set this to MX.

MAX. BAKE TEMPERATURE –

Can be set up to 300C , (depending on the oven type)

TEMPERATURE OFFSET –

Can be used to adjust the display to the actual temperature in the oven.

BAKE HYSTERISIS –

Sets bake temperature cycling around a set point. (Above and below).

SLEEP FALLBACK –

Temperature of the oven in “sleep mode” (100C is suggested).

SLEEP HYSTERISIS –

Sets “sleep mode” temperature cycling around a set point. (Above and below).

READY ACCEPT HIGH –

Highest temperature for the oven to display “READY”

READY ACCEPT LOW –

Lowest temperature for the oven to display “READY”

FAN DELAY AFTER STEAM –

Delay before fan starts after the oven has steamed. (60 seconds max)

LIGHT OUTPUT SOFT START –

On/Off Some lights need this for cold start up to stop them blowing.

AUTO FAN CYCLE TIME (MINS) –

Set time required. Only used in manual and multibake modes.

AUTO FAN DWELL TIME –

Set time required. Only used in manual and multibake modes.

HEATER CONTROL –

Contact or solid state. Defaults to contactor. (solid state not used at the moment)

I/O DIAGNOSTIC –

Displays outputs and inputs at the top of the screen to aid fault finding if needed.

DEFAULT PASSCODES

SUPERVISOR (LOW LEVEL) -- 123456

HIGH LEVEL -- 654321

MASTER -- 314159 (This is fixed)

SUGGESTION

To stop unauthorised changes to the oven setup, it is suggested that this page is removed from this manual and kept in a safe place for future reference.

If tampering could be a problem, It is a good idea to change the passcodes at regular intervals,.

9 - 7 USING THE USB PORT

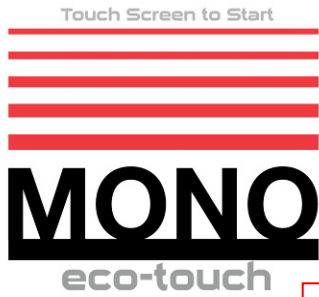

START SCREEN

Ensure the Start screen is showing **1**



Insert the USB memory stick into the socket on the oven panel. (Rubber plug may have to be removed first).

2

NOTE
The USB stick will only fit in one way.
Do not force into the socket.



Wait for the USB symbol to finish moving **3**

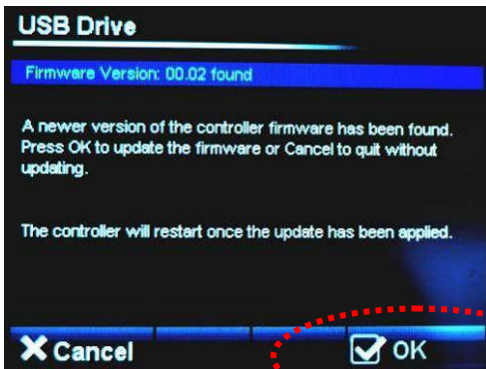

If old firmware is found, the firmware version screen will appear.

Touch "OK" to update firmware
-Wait-
Remove USB stick
OR
Touch "CANCEL" to choose other items to update or change. (see next page)

4

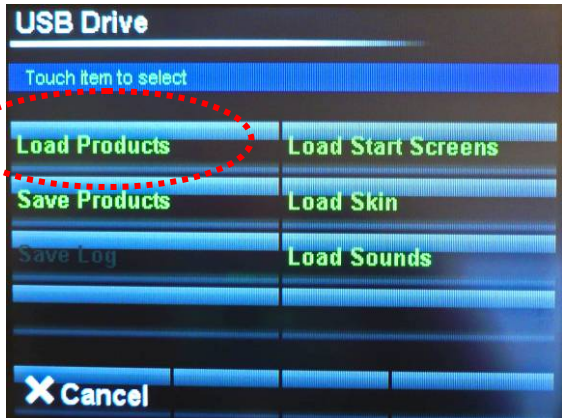

Choose action you would like to do. **5**



Select the file required. **6**

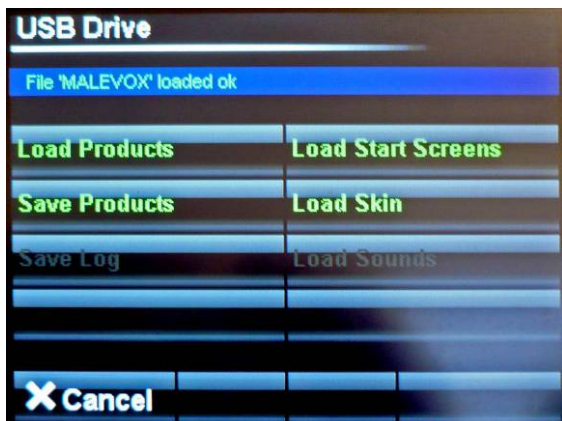

When confirmation of "file loaded ok" Shows, remove the usb stick. **7**

NOTES ON USING USB STICKS

For a USB stick to function correctly it must have the following folder in the root folder .

Mono

Then into that folder add the following:

Firmware
Products
Skins
Sounds
Start-up

Place your recipe/product files in the “**products**” folder.

The oven will find the “**Mono**” folder automatically when the stick is plugged into the oven.
 Any stick can be used (does not have to be blank) but the Mono folder must be in the root folder.

The most used folders are explained below:

SKINS

These control the way the screen looks in different modes.

Pictorial is when the screen displays categories using pictures.



Numerical is when the screen displays program numbers.



STARTUP SCREENS

This is the picture/logo you see when the oven is started.



PRODUCT FILES (PROGRAM FILES)

These are the files that contain the information for baking each product e.g. bread,buns,cakes etc.

9 – 8 DIAGNOSTICS

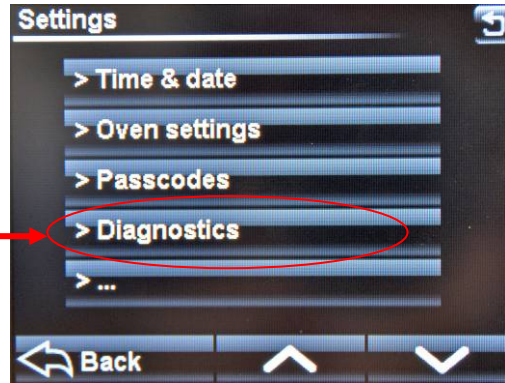

SETTINGS SCREEN

TOUCH "DIAGNOSTICS" AND THE FOLLOWING SCREEN WILL APPEAR.

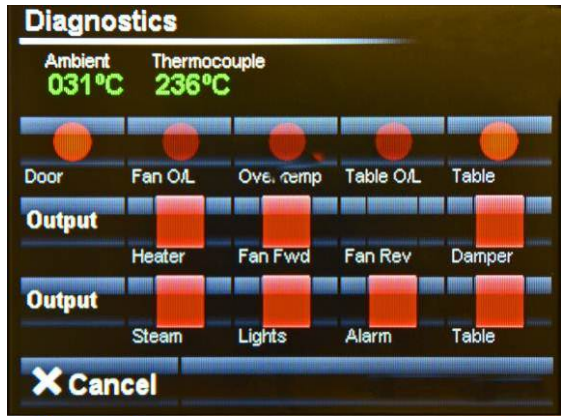

DIAGNOSTICS SCREEN

INPUTS HIGHLIGHT WHEN A SIGNAL IS Received.
e.g. DOOR OPEN

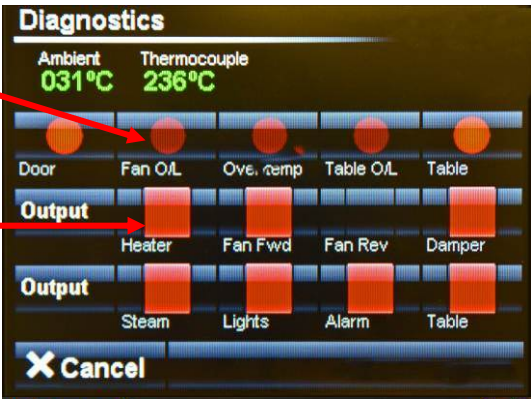

TOUCH THE REQUIRED OUTPUT AND A SIGNAL IS SENT TO THAT ITEM. THE OUTPUT BEING CHECKED IS HIGHLIGHTED WHEN ACTIVE. TO STOP THE OUTPUT, PRESS AGAIN.

10.0 TROUBLE SHOOTING

IMPORTANT!

All repairs and adjustments to the oven must be carried out by authorised experts. Isolate oven before attempting repairs or removing protective panels.

Symptom	Possible cause	Probable solution
The oven does not start, no fault shown on control panel	The main isolator switch is off.	Switch on the isolator.
	The auxiliary fuse is tripped.	Reset the fuse.
	The main fuse is tripped.	Change the fuse (before the oven).
Neither fan, hanger, steam or heat starts	Door is not closed. Door switch is defective.	Close door. Replace door switch.
Rack hanger does not rotate and no fault shown on control panel	Drive belt slipping. Drive belt broken	Check belt tension. Replace belt.
Oven light is not working	Light is strip is defective. Faulty wiring to light.	Replace the light strip. Repair wiring.
Oven temperature fails to rise/rises slowly/ cannot be maintained during baking	No gas supply. Damper is open. Fan motor tripped. Burner reset activated.	Check supply. Close damper. Reset fan trip. Call service engineer.
Little or no steam	Water mains disconnected or closed. Water spreader tube blocked. Filter in water line blocked. Solenoid valve defective.	Connect water supply or open supply valve. Clean/unblock spreader tube. Clean filter. Replace solenoid valve.
Oven bakes unevenly	Air slot not adjusted correctly. Fan motor running in the wrong direction.	Adjust air slots. See section <i>Adjusting air slots</i> . Switch electrical connections. Direction of rotation is indicated by arrow adjacent to motor.

Red light above control panel

Burner reset

The burner reset button is located above the control panel. After 3 failed attempts of igniting, the button will illuminate signalling that the burner has locked out.

To reset, press the button until the light goes out.

The burner will then attempt to ignite 3 more times.

If the burner continuously fails, contact a qualified gas engineer.

BURNER RESET
BUTTON



DO NOT ATTEMPT TO MAKE ADJUSTMENTS UNLESS YOU ARE FULLY AWARE OF THE RESULTS

Setting the air slots

The oven has an air panel situated in the rear right-hand corner of the baking chamber with adjustable slots, which are accurately set prior to leaving the factory (the factory settings are given in the diagram below). It is through these slots that heated air passes into the baking chamber to perform the baking task. However, external factors can negatively affect the baking result, such as a poorly designed baking programme or the combination of trays and products to be baked, and adjustment of the air slots may be necessary.

However, before making adjustments please consider the following:

- Make sure that differences in baking results are not due to differences in product batches;
- Make sure that the plates that determine the width of the air slot have not come loose thereby causing a change from the factory setting;
- Do not be too hasty in changing air slot settings in response to a sudden change in bake evenness as this may have been caused by other factors, such as, after maintenance of the oven, or a related fault with the oven. Any adjustments to the air slots would be unlikely to cure bake unevenness under these circumstances;
- Check that the air circulation fan's rotation is correct – especially after maintenance or replacement.

If it is considered that adjustments to the air slots are necessary, these should be made in small increments and one slot at a time. Measure the slot opening before adjustment then slacken the screw(s) associated with the slot that requires adjustment, adjust slot opening then retighten screw. Measure slot opening after adjustment is complete to confirm the desired dimension has been achieved.

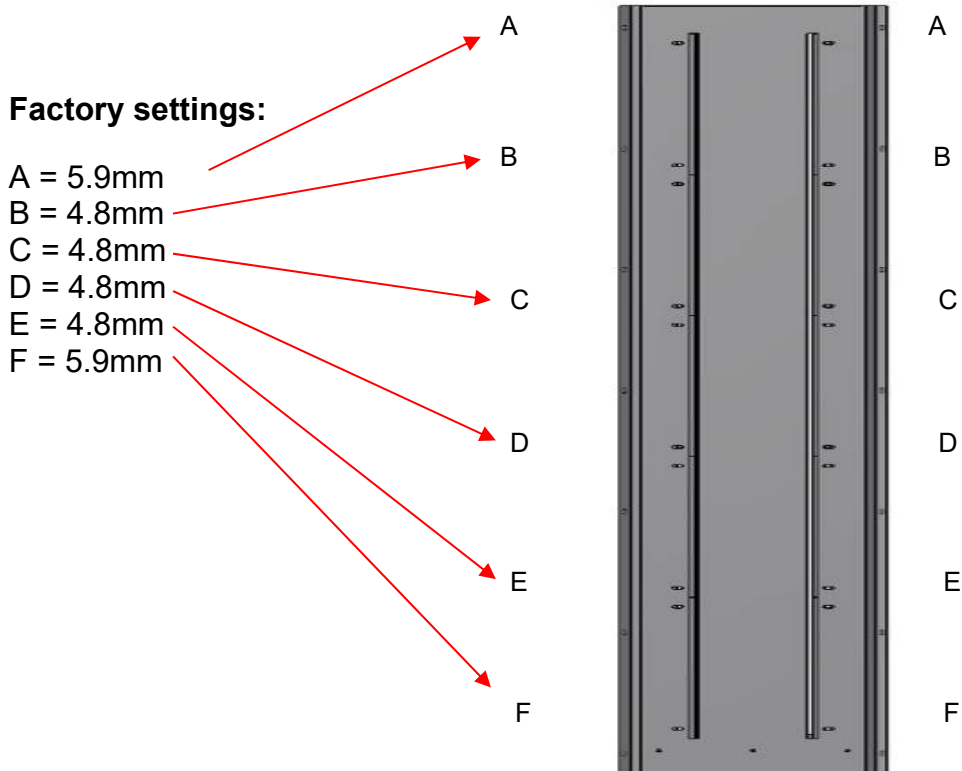

11.0 SPARES AND SERVICE ---

If a fault arises, please do not hesitate to contact the Customer Service Department, quoting the **machine serial number** on the silver information plate of the machine and on the front cover of this manual.

All correspondence must state the details shown on the oven's identification plate. *This will reduce errors and time wasted during communication.*

MONO

Queensway

Swansea West Industrial Estate

Swansea. SA5 4EB UK

email: spares@monoequip.com

Web site: www.monoequip.com

Tel. 01792 561234

Spares +44(0)1792 564039



12.0 ELECTRICAL INFORMATION

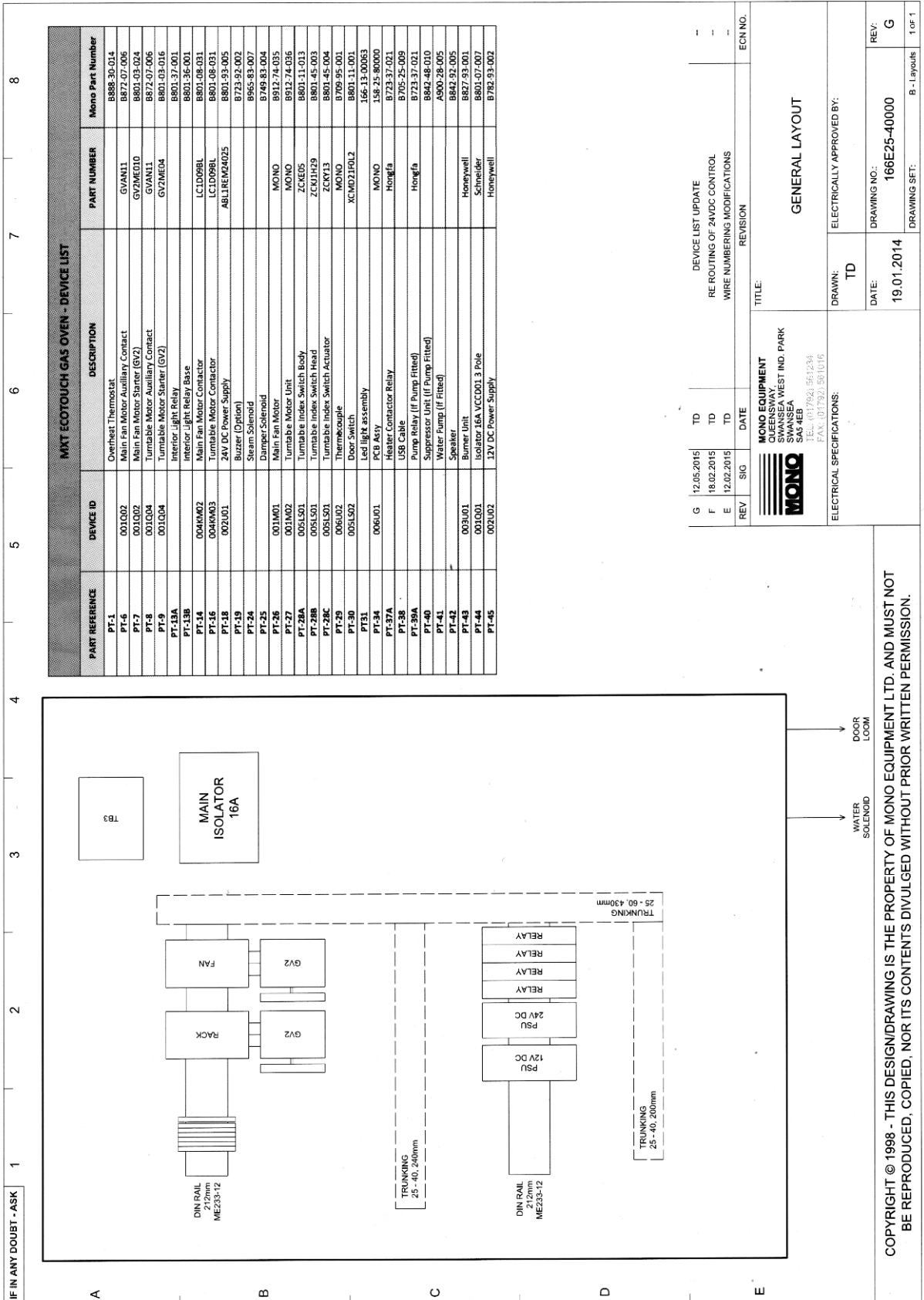

IF IN ANY DOUBT - ASK

MX ECO TOUCH GAS OVEN - DEVICE LIST

PART REFERENCE	DEVICE ID	DESCRIPTION	PART NUMBER	Mono Part Number
PT-1		Overheat Thermostat		B888-30-014
PT-5	001L02	Main Fan Motor Auxiliary Contact	GVAN11	B872-07-006
PT-6	001L02	Main Fan Motor Starter (GVZ)	GVZMED10	B801-03-024
PT-7	001L04	Tumble Motor Auxiliary Contact	GVAN11	B872-07-006
PT-8	001L04	Tumble Motor Starter (GVZ)	GVZMED4	B801-03-016
PT-9	001L04	Tumble Motor Starter (GVZ)	GVZMED4	B801-03-016
PT-13A		Interior Light Relay		B801-37-001
PT-13B		Interior Light Relay Base		B801-36-001
PT-14	004KM02	Main Fan Motor Contactor	LC1D09BL	B801-08-031
PT-16	004KM03	Tumble Motor Contactor	LC1D09BL	B801-08-031
PT-18	002J01	24V DC Power Supply	ABLREIM24025	B801-93-005
PT-19		Buzzer (Option)		B723-92-002
PT-24		Steam Solenoid		B965-83-007
PT-25		Damper Solenoid		B749-83-004
PT-26	001M01	Main Fan Motor	MONO	B912-74-035
PT-27	001M02	Tumble Motor Unit	MONO	B912-74-036
PT-28A	005L501	Tumble Index Switch Body	ZCKE05	B801-11-013
PT-28B	005L501	Tumble Index Switch Head	ZCKJH29	B801-45-003
PT-28C	005L501	Tumble Index Switch Actuator	ZCKY13	B801-45-004
PT-29	006J02	Thermocouple	MONO	B709-95-001
PT-30	005L502	Door Switch	KCMD21POL2	B801-11-001
PT-31		Lead light assembly		166-13-00063
PT-34	006J01	PCB Assy	MONO	158-25-80000
PT-37A		Heater Contactor Relay	Hongfa	B723-37-021
PT-38		USB Cable		B705-25-009
PT-39A		Pump Relay (If Pump Fitted)	Hongfa	B723-37-021
PT-40		Suppressor Unit (If Pump Fitted)		B842-48-010
PT-41		Water Pump (If Fitted)		A900-28-005
PT-42		Speaker		B842-82-005
PT-43	003L01	Burner Unit	Honeywell	B827-93-001
PT-44	001L01	ISOLATOR 16A VCC001 3 Pole	Schneider	B801-07-007
PT-45	002L02	12V DC Power Supply	Honeywell	B782-93-002

G	12.05.2015	TD	DEVICE LIST UPDATE		
F	16.02.2015	TD	RE ROUTING OF 24VDC CONTROL WIRE NUMBERING MODIFICATIONS		
E	12.02.2015	TD	REVISION		
REV	SIG	DATE	TITLE:		
			MONO EQUIPMENT AGENTS SWANSEA WEST IND. PARK SWANSEA SAS 4EB E-mail: 01792-561234 Fax: 01792-561616		
ELECTRICAL SPECIFICATIONS:			DRAWN: TD		
ELECTRICALLY APPROVED BY:			DRAWING NO.: 166E25-40000		
			DATE: 19.01.2014		
			REV: G		
			DRAWING SET: B - Layout		
			1 of 1		

COPYRIGHT © 1998 - THIS DESIGN/DRAWING IS THE PROPERTY OF MONO EQUIPMENT LTD. AND MUST NOT BE REPRODUCED, COPIED, NOR ITS CONTENTS DIVULGED WITHOUT PRIOR WRITTEN PERMISSION.

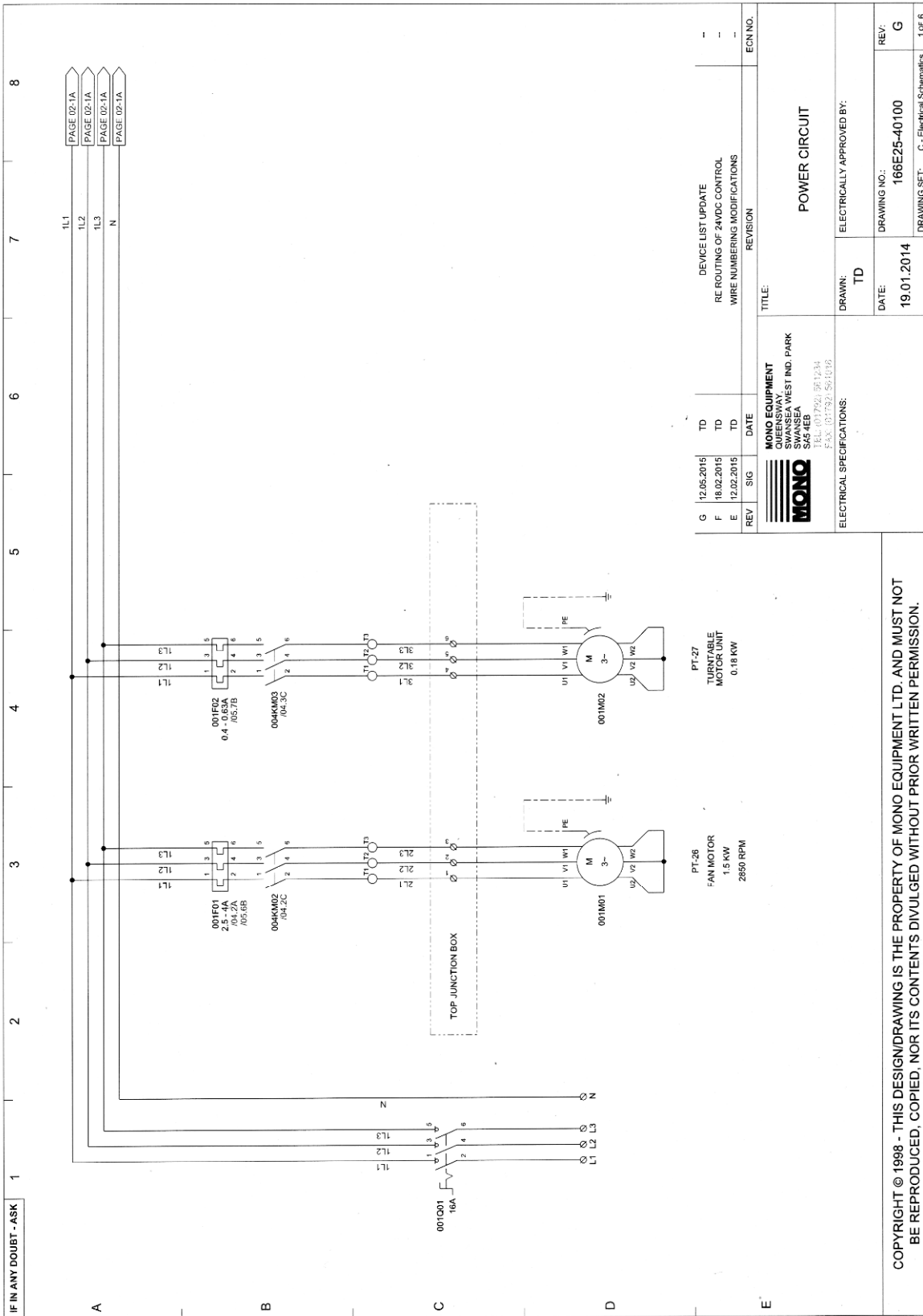

IF IN ANY DOUBT - ASK

PAGE 02-1A
PAGE 02-1A
PAGE 02-1A
PAGE 02-1A

REV	SIG	DATE	DESCRIPTION	ECN NO.
G		12.05.2015	TD	
F		18.02.2015	TD	
E		12.02.2015	TD	

REV	SIG	DATE	DESCRIPTION	ECN NO.
G		12.05.2015	TD	
F		18.02.2015	TD	
E		12.02.2015	TD	

PT-27
TURNTABLE
MOTOR UNIT
0.18 KW

PT-26
FAN MOTOR
1.5 KW
2850 RPM

MONO EQUIPMENT SWANSEA WEST IND. PARK SWANSEA SA5 4EB 01633 7901 551234 01633 7922 551438		TITLE: POWER CIRCUIT
ELECTRICAL SPECIFICATIONS: DRAWN: TD DATE: 19.01.2014	ELECTRICALLY APPROVED BY:	DRAWING NO: 166E25-40100 REV: G
		DRAWING SET: C - Electrical Schematics 1 of 6

COPYRIGHT © 1998 - THIS DESIGN/DRAWING IS THE PROPERTY OF MONO EQUIPMENT LTD. AND MUST NOT BE REPRODUCED, COPIED, NOR ITS CONTENTS DIVULGED WITHOUT PRIOR WRITTEN PERMISSION.

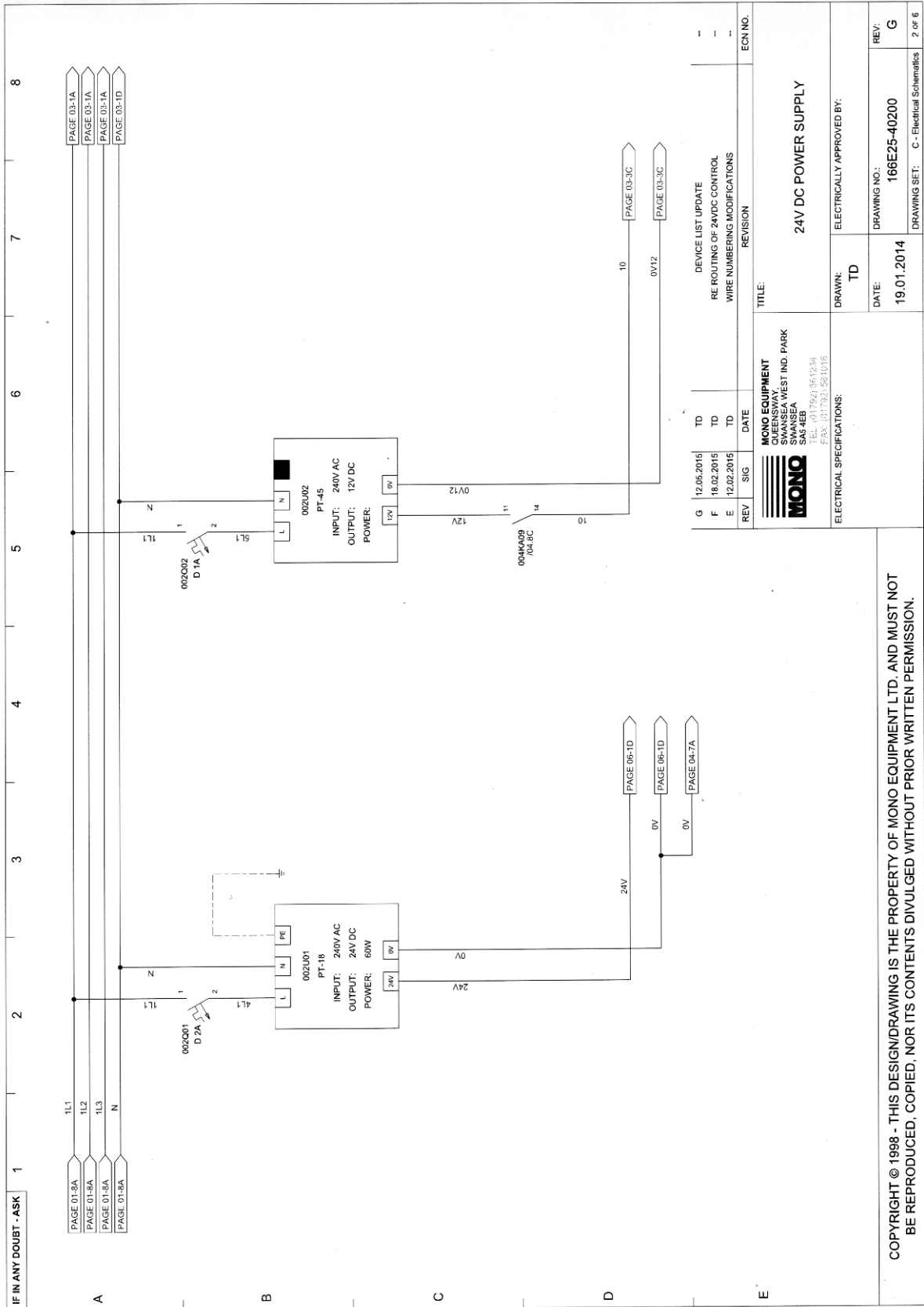

REV	SIG	DATE	REVISION	ECN NO.
G		12.05.2015	TD	
F		18.02.2015	TD	
E		12.02.2015	TD	

DEVICE LIST UPDATE	RE ROUTING OF 24VDC CONTROL	WIRE NUMBERING MODIFICATIONS
-	-	-

TITLE	
MONO EQUIPMENT	24V DC POWER SUPPLY

ELECTRICAL SPECIFICATIONS:	
DRAWN:	TD
DATE:	19.01.2014
DRAWING NO.:	166E25-40200
DRAWING SET:	C - Electrical Schematics
REV:	G
ELECTRICALLY APPROVED BY:	

MONO EQUIPMENT
 SWANSEA WEST IND. PARK
 SWANSEA
 SA5 4EB
 TEL: 01792 5541034
 FAX: 01792 581016

COPYRIGHT © 1998 - THIS DESIGN/DRAWING IS THE PROPERTY OF MONO EQUIPMENT LTD. AND MUST NOT BE REPRODUCED, COPIED, NOR ITS CONTENTS DIVULGED WITHOUT PRIOR WRITTEN PERMISSION.

IF IN ANY DOUBT - ASK 1 2 3 4 5 6 7 8

PAGE 03-1A
 PAGE 03-1A
 PAGE 03-1A
 PAGE 03-1D

PAGE 01-8A
 PAGE 01-8A
 PAGE 01-8A
 PAGE 01-8A

PAGE 06-1D
 PAGE 06-1D
 PAGE 04-7A

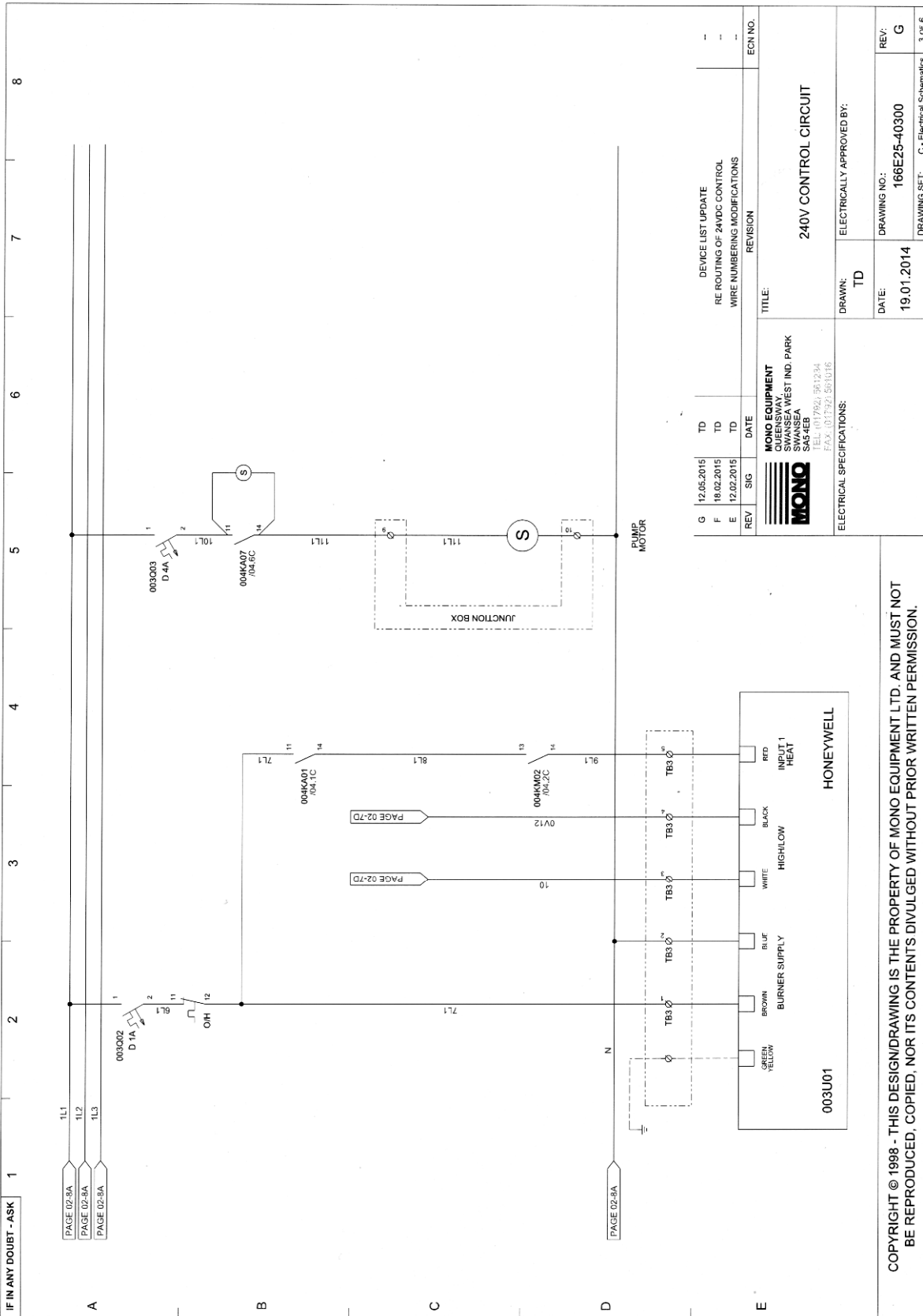

COPYRIGHT © 1998 - THIS DESIGN/DRAWING IS THE PROPERTY OF MONO EQUIPMENT LTD. AND MUST NOT BE REPRODUCED, COPIED, NOR ITS CONTENTS DIVULGED WITHOUT PRIOR WRITTEN PERMISSION.

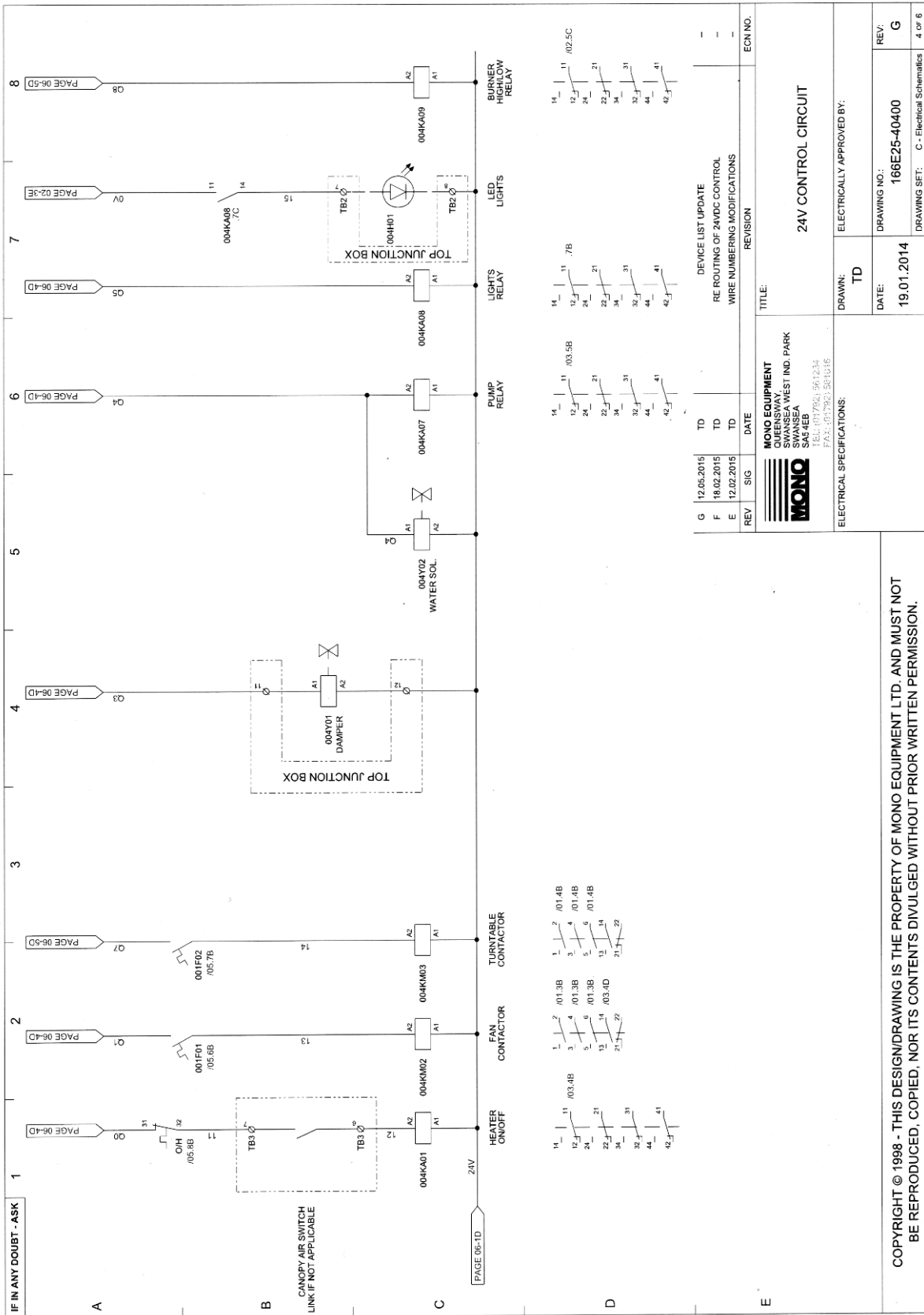

COPYRIGHT © 1998 - THIS DESIGN/DRAWING IS THE PROPERTY OF MONO EQUIPMENT LTD. AND MUST NOT BE REPRODUCED, COPIED, NOR ITS CONTENTS DIVULGED WITHOUT PRIOR WRITTEN PERMISSION.

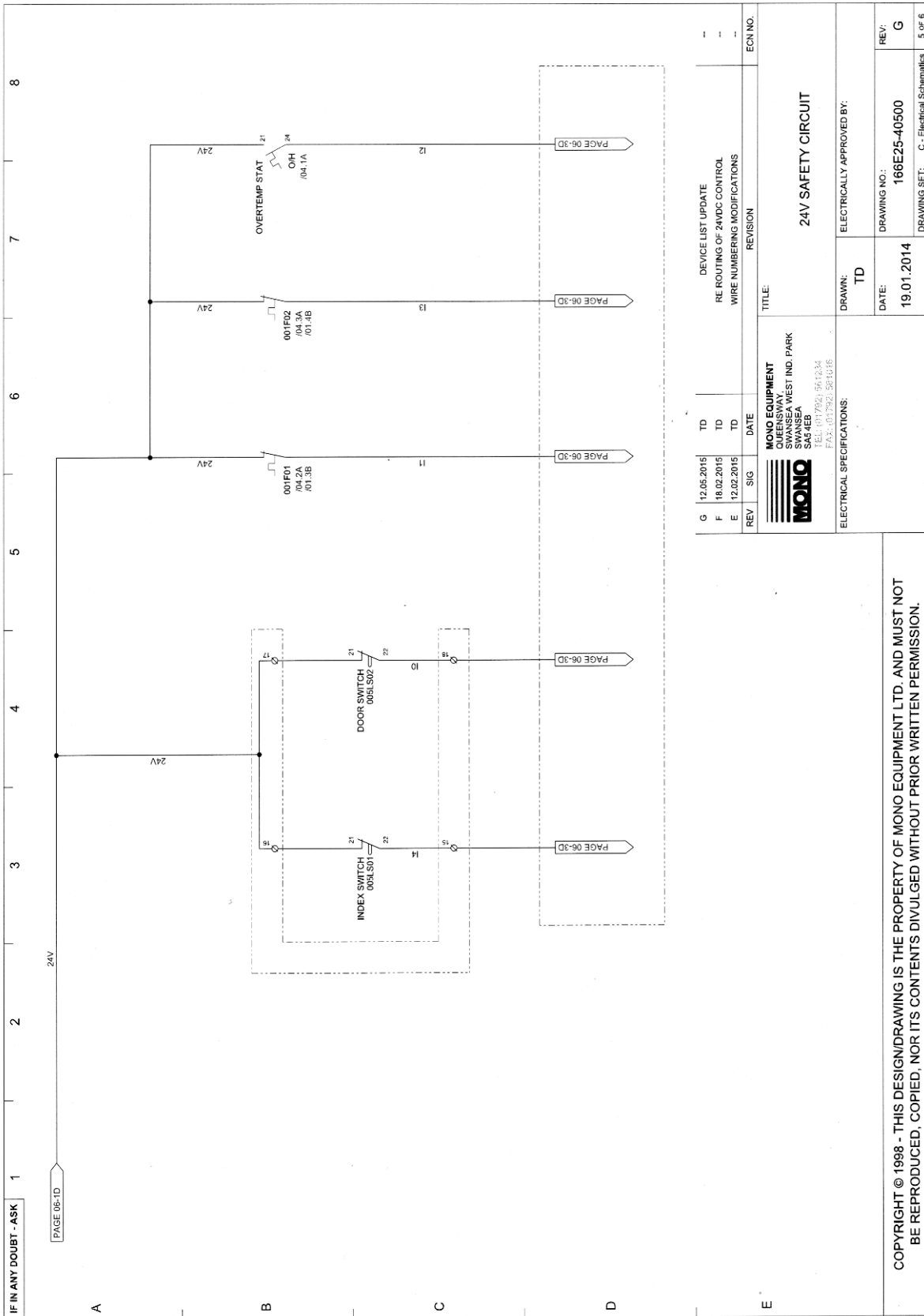

REV	SIG	DATE	DESCRIPTION	ECN NO.
G		12.05.2015	TD	
F		18.02.2015	TD	
E		12.02.2015	TD	
REVISION				
TITLE:				
MONO EQUIPMENT SWANSEA WEST IND. PARK SWANSEA SAS 4EB TEL: 01792 561234 FAX: 01792 561235				
ELECTRICAL SPECIFICATIONS:				
DRAWN: TD				
DATE: 19.01.2014				
DRAWING NO.: 166E25-40500				
DRAWING SET: C - Electrical Schematics				
REV: G				
5 of 6				

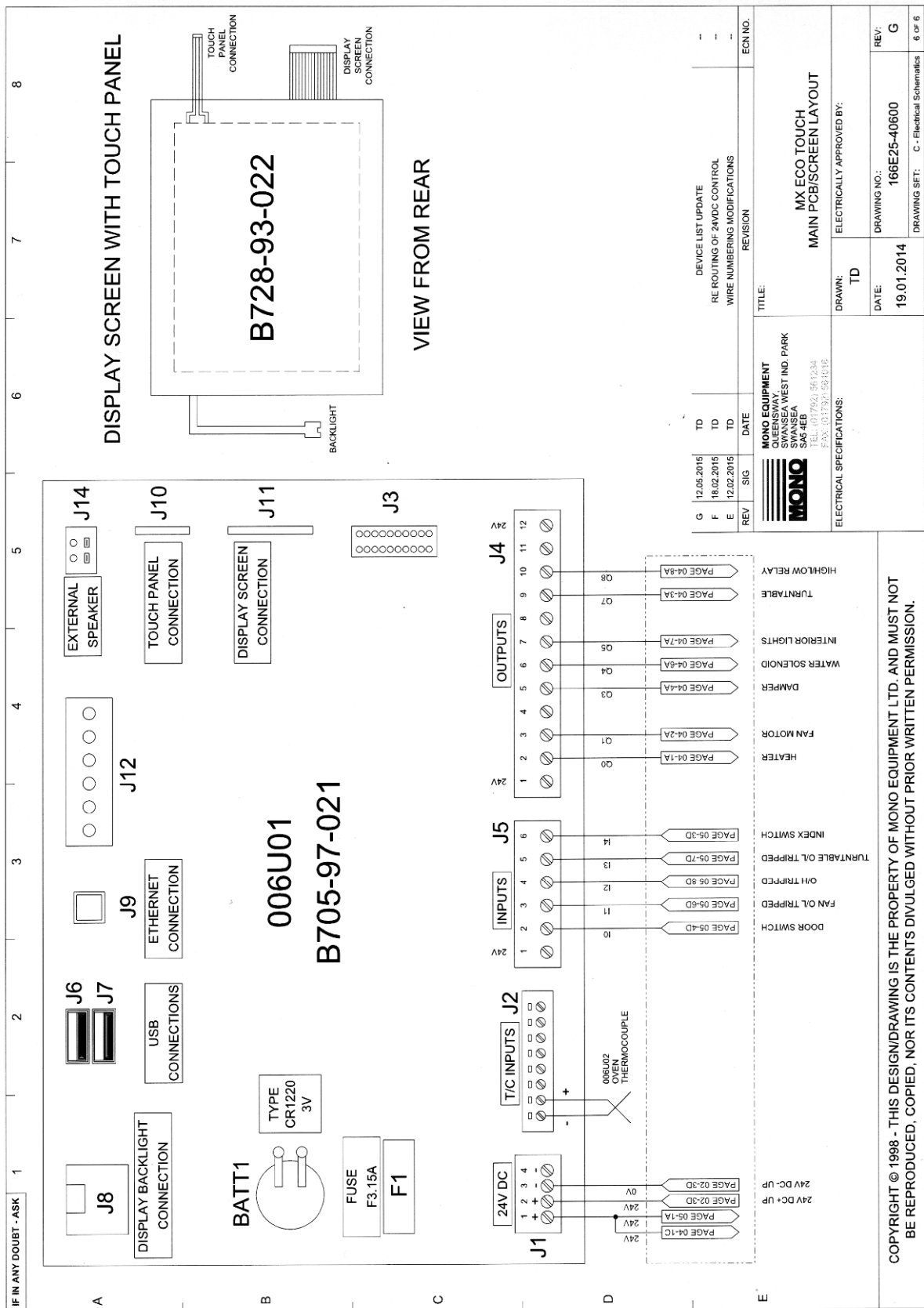

COPYRIGHT © 1998 - THIS DESIGN/DRAWING IS THE PROPERTY OF MONO EQUIPMENT LTD. AND MUST NOT BE REPRODUCED, COPIED, NOR ITS CONTENTS DIVULGED WITHOUT PRIOR WRITTEN PERMISSION.



13.0 SPARES

SPARES

<u>DESCRIPTION</u>	<u>PART NUMBER</u>
Overheat thermostat	B888-30-014
Main fan motor auxiliary contact	B872-07-006
Main fan motor starter	B801-03-024
Turntable motor aux contact	B872-07-006
Turntable motor starter	B801-03-016
Interior Light relay	B801-37-001
Interior light relay base	B801-36-001
Main fan motor contactor	B801-08-031
Turntable motor contactor	B801-08-031
24v DC power supply	B801-93-005
12V DC power supply	B782-93-002
Steam solenoid	B965-83-007
Damper solenoid	B749-83-004
Main fan motor	B912-74-035
Turntable motor unit	B912-74-036
Turntable index switch body	B801-11-013
Turntable index switch head	B801-45-003
Turntable index switch actuator	B801-45-004
Thermocouple	B709-95-001
Door switch	B801-11-001
LED light assembly complete	166-13-00057
PCB Assembly	158-25-80000
Heater contactor relay	B723-37-021
USB cable	B705-25-009
Burner unit	B827-93-001
Isolator 16A 3 pole	B801-07-007
Fan drive "VEE" belt	A900-21-114
Door handle	160-32-02000
Bottom door seal	166-13-00060
Door glass unit	166-13-00035
"U" seal for glass unit	166-13-00055
Touch screen overlay	164-90-00001
Touchscreen and board	158-25-80000

PARTS LIST FOR OPTIONAL RACK TURNTABLE

(Factory-fitted to FG166-G****TT models only)

Figure 2: Parts list for Standard Rack Turntable

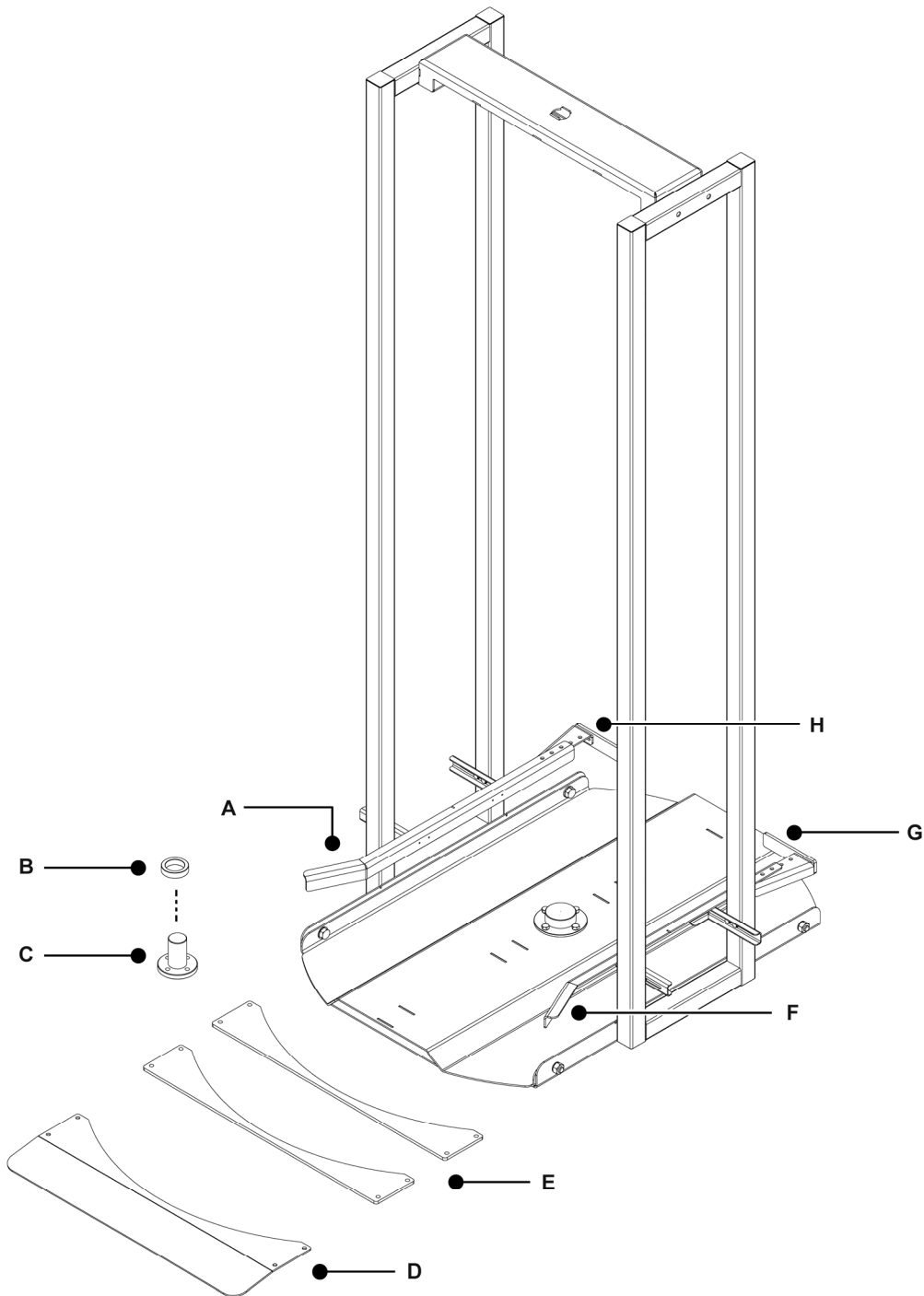

-
- | | |
|--|---|
| A. Left-hand adjustable side guide (166-17-00051) | E. Ramp packer (166-17-00021) |
| B. Base bearing (166-17-00014) | F. Right-hand adjustable side guide (166-17-00053) |
| C. Floor turntable boss (166-17-00017) | G. Back stop plate (166-17-00064) |
| D. Turntable ramp (166-17-00019) | |
-

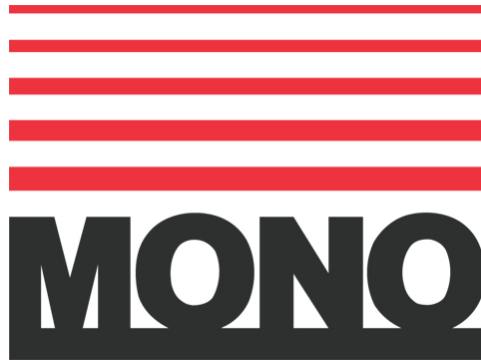

MONO

Queensway
Swansea West Industrial Estate
Swansea. SA5 4EB UK

email: spares@monoequip.com
Web site: www.monoequip.com

Tel. 01792 561234
Spares +44(0)1792 564039