



www.monoequip.com



Harmony

MODULAR DECK OVEN

— SPARES MANUAL —

MACHINE NO.FG257

When ordering spares please quote the **machine serial number** which can be found on the silver information plate of the machine and on the front cover of your manual.

MONO EQUIPMENT
Queensway
Swansea West Industrial Estate
Swansea. SA5 4EB UK

Tel. +44(0)1792 561234
email:spares@monoequip.com
Spares Tel. +44(0)1792 564039
Fax. 01792 561016

MODULAR DECK OVEN

	PAGE
ELEMENT SPARES NUMBERS	- 3
DECK MOVEN PART LOCATIONS	- 4
PART INFORMATION	- 5
DOOR ASSEMBLIES	- 7
ELECTRICAL PANEL MAIN COMPONENTS	- 8
3 TRAY ELECTRICAL PARTS LIST	- 9
2 TRAY ELECTRICAL PARTS LIST	-10
1 TRAY ELECTRICAL PARTS LIST	-11
OVEN CANOPY PARTS LIST	-12
ELECTRICAL LINKING INFORMATION DRAWING	-13
TOP CANOPY MCB WIRING INFORMATION DRAWING	-14
POWER CIRCUIT DIAGRAM	-15
CONTROL CIRCUIT DIAGRAM	-16
POWER CIRCUIT DIAGRAM	-17
ELEMENT WIRING DIAGRAM	-18
ISOLATOR WIRING DIAGRAM	-19

ELEMENT SPARES

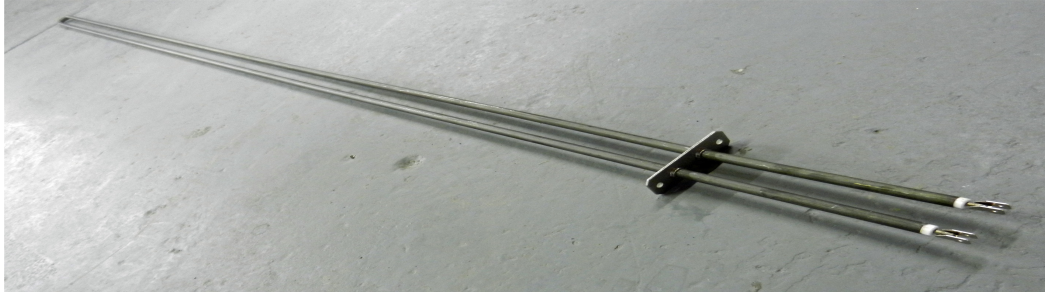

3 ACROSS

TOP HEAT ELEMENT 1.0kW	B854-04-093
TOP HEAT ELEMENT 0.6kW	B854-04-091
BOTTOM HEAT ELEMENT 0.75kW	B854-04-092

2 ACROSS

TOP HEAT ELEMENT 0.65kW	B854-04-102
TOP HEAT ELEMENT 0.4kW	B854-04-100
BOTTOM HEAT ELEMENT 0.5kW	B854-04-101

1 ACROSS



TOP HEAT ELEMENT 0.325kW	B854-04-111
TOP HEAT ELEMENT 0.2kW	B854-04-109
BOTTOM HEAT ELEMENT 0.25kW	B854-04-110

DECK OVEN PART LOCATIONS

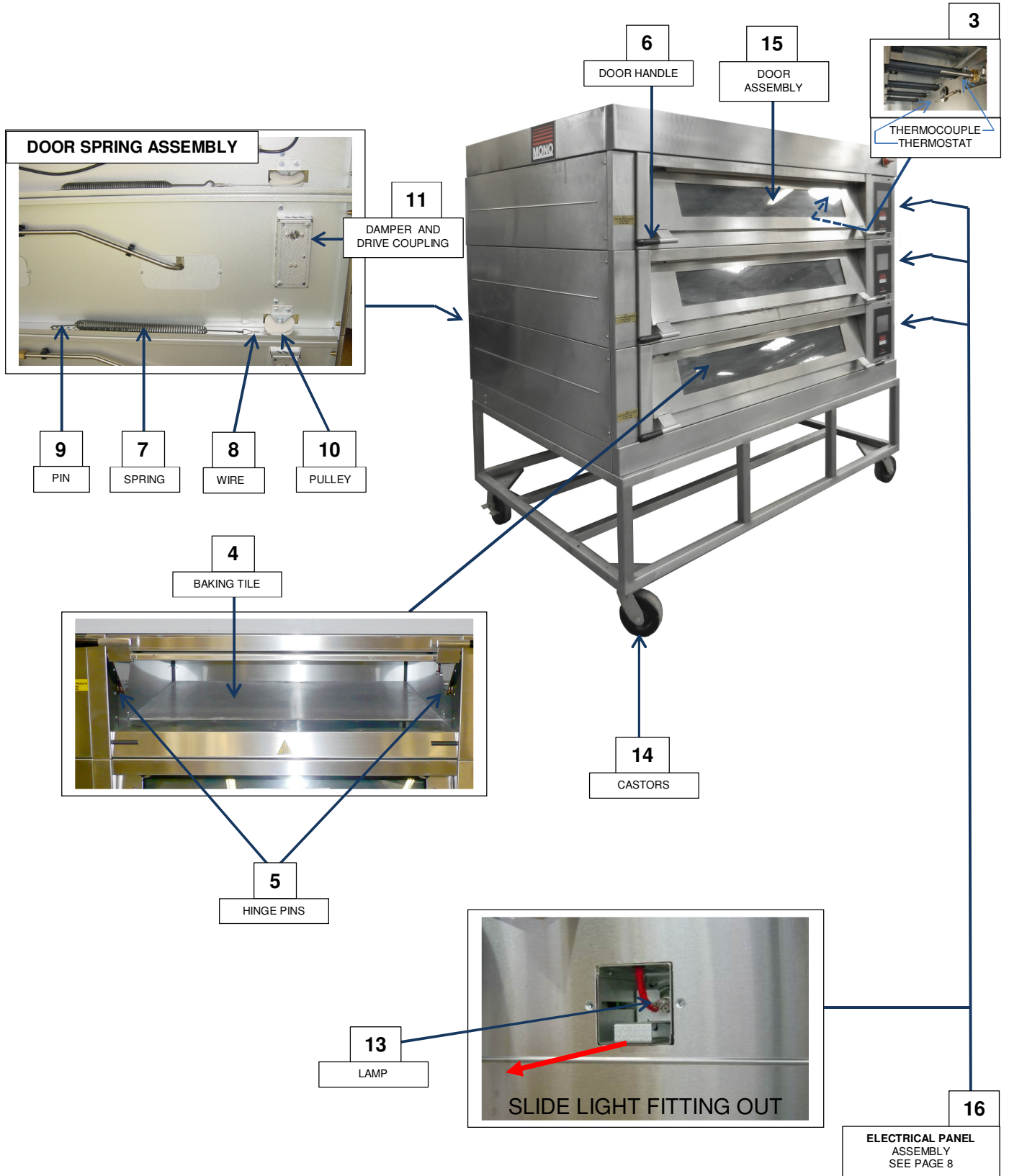
ITEM PART NUMBERS ARE ON THE FOLLOWING PAGES



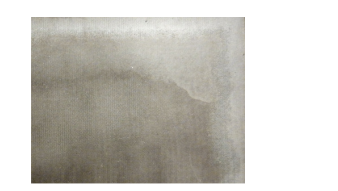

DECK OVEN PART INFORMATION

	<p>FROSTED GLASS (LIGHTS) PART No.257-02-00027</p>	<p>1</p>	
	<p>PLAIN GLASS (LIGHTS) PART No.257-02-00028</p>	<p>2</p>	
	<p>THERMOCOUPLE PART No.B873-95-007</p>	<p>3</p>	
	<p>THERMOSTAT PART No.B888-30-014</p>		
	<p>BAKING TILE</p> <p>3 ACROSS PART No.257-02-00046 2 ACROSS PART No.257-02-00047 1 ACROSS PART No.257-02-00048</p>	<p>4</p>	
 <p>LH</p>	 <p>RH</p>	<p>HINGE PIN LH PART No.257-03-00009</p> <p>HINGE PIN RH PART No.257-03-00005</p>	<p>5</p>
	<p>BLACK DOOR HANDLE PART No.A900-27-192</p>	<p>6</p>	
	<p>DOOR SPRING PART No.257-03-00017</p>	<p>7</p>	

	<p align="center">WIRE ROPE PART No.257-03-00024</p>	<p align="center">8</p>
--	---	--------------------------------

	<p align="center">SPRING RETAINING PIN PART No.257-03-00025</p>	<p align="center">9</p>
---	--	--------------------------------

		<p align="center">PULLEY PART No.257-03-00015</p> <p align="center">PULLEY SPINDLE PART No.257-03-00013</p>	<p align="center">10</p>
<p align="center">PULLEY</p>	<p align="center">SPINDLE</p>		

		<p align="center">DAMPER DRIVE COUPLING PART No.257-07-00007</p> <p align="center">DAMPER SOLENOID PART No.B749-83-004</p>	<p align="center">11</p>
<p align="center">COUPLING</p>	<p align="center">SOLENOID</p>		



	<p align="center">ELEMENT GASKET PART No.245-02-01300</p>	<p align="center">12</p>
---	--	---------------------------------

	<p align="center">20w DICHOIC LAMP PART No.B855-94-008</p>	<p align="center">13</p>
---	---	---------------------------------

	<p align="center">CASTORS 5-DECK ONLY BRAKED PART No.A900-20-053 UNBRAKED PART No.A900-20-052</p> <p align="center">CASTORS 4/3/2 DECKS BRAKED PART No.A900-20-033 UNBRAKED PART No.A900-20-034</p>	<p align="center">14</p>
---	---	---------------------------------

DOOR ASSEMBLIES

	<p>3 ACROSS <u>GLASS</u> DOOR ASSEMBLY PART No.257-03-00095</p>	<p>15</p>	<p>GLASS</p>
	<p>2 ACROSS <u>GLASS</u> DOOR ASSEMBLY PART No.257-03-00114</p>		
	<p>1 ACROSS <u>GLASS</u> DOOR ASSEMBLY PART No.257-03-00129</p>		

	<p>3 ACROSS <u>SOLID</u> DOOR ASSEMBLY PART No.257-03-00121</p>	<p>15</p>	<p>SOLID</p>
	<p>2 ACROSS <u>SOLID</u> DOOR ASSEMBLY PART No.257-03-00122</p>		
	<p>1 ACROSS <u>SOLID</u> DOOR ASSEMBLY PART NOT AVAILABLE</p>		

ELECTRICAL PANEL MAIN COMPONENTS

ITEM REFERENCES REFER TO PARTS SHOWN ON NEXT PAGES AND ELECTRICAL DRAWINGS

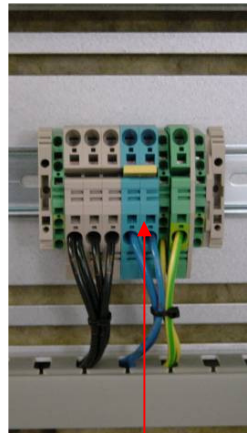
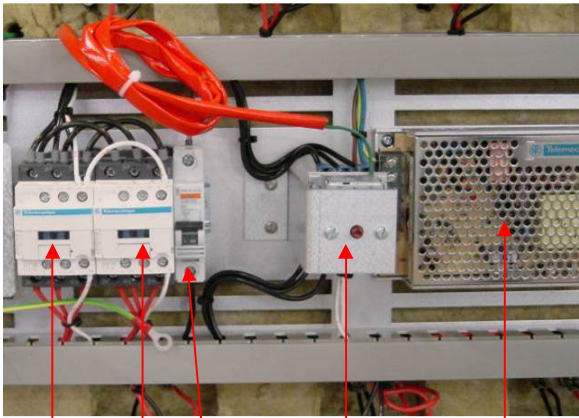
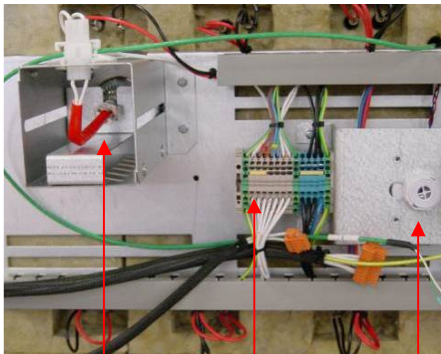
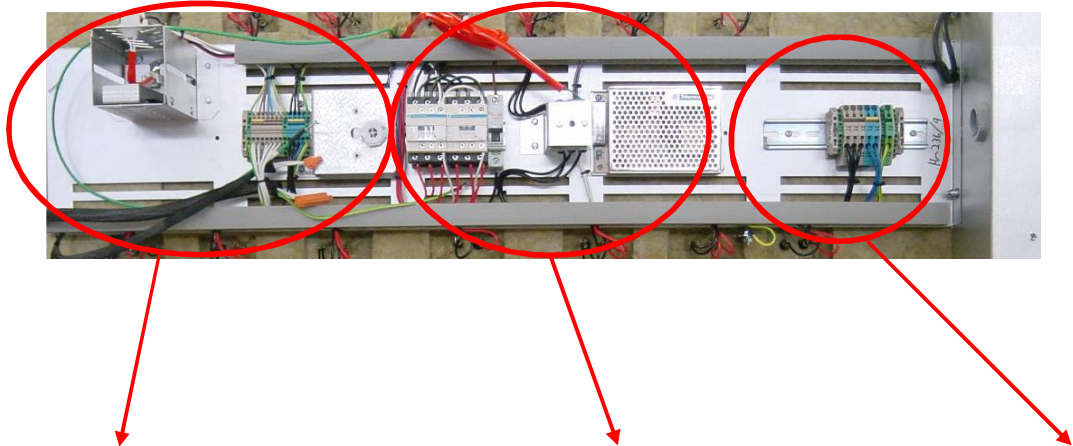

H1
TB2
S1
K1
K2
F4
F5
POWER SUPPLY
B801-93-005
TB1

OPTIONAL

OVERHEAT
THERMOSTAT
B888-30-014

INTERIOR
LIGHT
B855-94-008

TOP
HEAT
CONTACTOR
B801-08-021

BOTTOM
HEAT
CONTACTOR
B801-08-021

CONTROL
POWER
SUPPLY
MCB
B872-22-062

ELECTRICAL PARTS LIST– 3 TRAY WIDE

DRG REF.	<u>DESCRIPTION</u>	<u>PART NUMBER</u>
F1	HEATERS MCB	B872-22-007
F2	HEATERS MCB	B872-22-007
F3	HEATERS MCB	B872-22-007
F4	CONTROL POWER SUPPLY MCB	B872-22-062
F5	OVERHEAT THERMOSTAT	B888-30-014
T1	CONTROL CIRCUIT POWER SUPPLY	B801-93-005
K1	TOP HEAT CONTACTOR	B801-08-021
K2	BOTTOM HEAT CONTACTOR	B801-08-021
Y1	WATER SOLENOID (8mm pipe)	A900-34-365
H1	INTERIOR LIGHT	B855-94-008
B1	OVEN THERMOCOUPLE	B873-95-007
U1	MAIN ECO PRINTED CIRCUIT BOARD	M158-25-80000
D1	DAMPER SOLENOID	B749-83-004
R1	TOP HEAT ELEMENT 1.0kW	B854-04-093
R2	TOP HEAT ELEMENT 0.6kW	B854-04-091
R3	TOP HEAT ELEMENT 0.6kW	B854-04-091
R4	TOP HEAT ELEMENT 0.6kW	B854-04-091
R5	TOP HEAT ELEMENT 0.6kW	B854-04-091
R6	TOP HEAT ELEMENT 0.6kW	B854-04-091
R7	TOP HEAT ELEMENT 0.6kW	B854-04-091
R8	BOTTOM HEAT ELEMENT 0.75kW	B854-04-092
R9	BOTTOM HEAT ELEMENT 0.6kW	B854-04-091
R10	BOTTOM HEAT ELEMENT 0.6kW	B854-04-091
R11	BOTTOM HEAT ELEMENT 0.6kW	B854-04-091
R12	BOTTOM HEAT ELEMENT 0.6kW	B854-04-091
R13	BOTTOM HEAT ELEMENT 0.6kW	B854-04-091
R14	BOTTOM HEAT ELEMENT 0.6kW	B854-04-091

ELECTRICAL PARTS LIST – 2 TRAY WIDE

DRG REF.	<u>DESCRIPTION</u>	<u>PART NUMBER</u>
F1	HEATERS MCB	B872-22-006
F2	HEATERS MCB	B872-22-006
F3	HEATERS MCB	B872-22-006
F4	CONTROL POWER SUPPLY MCB	B872-22-062
F5	OVERHEAT THERMOSTAT	B888-30-014
T1	CONTROL CIRCUIT POWER SUPPLY	B801-93-005
K1	TOP HEAT CONTACTOR	B801-08-021
K2	BOTTOM HEAT CONTACTOR	B801-08-021
Y1	WATER SOLENOID (8mm pipe)	A900-34-365
H1	INTERIOR LIGHT	B855-94-008
B1	OVEN THERMOCOUPLE	B873-95-007
U1	MAIN ECO PRINTED CIRCUIT BOARD	M158-25-80000
D1	DAMPER SOLENOID	B749-83-004
R1	TOP HEAT ELEMENT 0.65kW	B854-04-102
R2	TOP HEAT ELEMENT 0.4kW	B854-04-100
R3	TOP HEAT ELEMENT 0.4kW	B854-04-100
R4	TOP HEAT ELEMENT 0.4kW	B854-04-100
R5	TOP HEAT ELEMENT 0.4kW	B854-04-100
R6	TOP HEAT ELEMENT 0.4kW	B854-04-100
R7	TOP HEAT ELEMENT 0.4kW	B854-04-100
R8	BOTTOM HEAT ELEMENT 0.5kW	B854-04-101
R9	BOTTOM HEAT ELEMENT 0.4kW	B854-04-100
R10	BOTTOM HEAT ELEMENT 0.4kW	B854-04-100
R11	BOTTOM HEAT ELEMENT 0.4kW	B854-04-100
R12	BOTTOM HEAT ELEMENT 0.4kW	B854-04-100
R13	BOTTOM HEAT ELEMENT 0.4kW	B854-04-100
R14	BOTTOM HEAT ELEMENT 0.4kW	B854-04-100

ELECTRICAL PARTS LIST – 1 TRAY WIDE

DRG REF.	<u>DESCRIPTION</u>	<u>PART NUMBER</u>
F1	HEATERS MCB Single phase only	B872-22-005
F2	HEATERS MCB	B872-22-005
F3	HEATERS MCB	B872-22-005
F4	CONTROL POWER SUPPLY MCB	B872-22-062
F5	OVERHEAT THERMOSTAT	B888-30-014
T1	CONTROL CIRCUIT POWER SUPPLY	B801-93-005
K1	TOP HEAT CONTACTOR	B801-08-021
K2	BOTTOM HEAT CONTACTOR	B801-08-021
Y1	WATER SOLENOID (8mm pipe)	A900-34-365
H1	INTERIOR LIGHT	B855-94-008
B1	OVEN THERMOCOUPLE	B873-95-007
U1	MAIN ECO PRINTED CIRCUIT BOARD	M158-25-80000
D1	DAMPER SOLENOID	B749-83-004
R1	TOP HEAT ELEMENT 0.35kW	B854-04-111
R2	TOP HEAT ELEMENT 0.2kW	B854-04-109
R3	TOP HEAT ELEMENT 0.2kW	B854-04-109
R4	TOP HEAT ELEMENT 0.2kW	B854-04-109
R5	TOP HEAT ELEMENT 0.2kW	B854-04-109
R6	TOP HEAT ELEMENT 0.2kW	B854-04-109
R7	TOP HEAT ELEMENT 0.2kW	B854-04-109
R8	BOTTOM HEAT ELEMENT 0.25kW	B854-04-110
R9	BOTTOM HEAT ELEMENT 0.2kW	B854-04-109
R10	BOTTOM HEAT ELEMENT 0.2kW	B854-04-109
R11	BOTTOM HEAT ELEMENT 0.2kW	B854-04-109
R12	BOTTOM HEAT ELEMENT 0.2kW	B854-04-109
R13	BOTTOM HEAT ELEMENT 0.2kW	B854-04-109
R14	BOTTOM HEAT ELEMENT 0.2kW	B854-04-109

OVEN CANOPY PARTS LIST

FG257-3-CF220 3 ACROSS CANOPY AND FAN (220V 1PH+E 60HZ)

FG257-3-CF400 3 ACROSS CANOPY AND FAN (230V 1PH+N+E 50HZ)

FG257-2-CF220 2 ACROSS CANOPY AND FAN (220V 1PH+E 60HZ)

FG257-2-CF400 2 ACROSS CANOPY AND FAN (230V 1PH+N+E 50HZ)

FG257-1-CF400 1 ACROSS CANOPY AND FAN (230V 1PH+N+E 50HZ)

	<p>CANOPY FAN CAPACITOR 4-6uf – 400VDB – METAL B869-23-005</p>	<p>1</p>
	<p>CANOPY FAN ON/OFF SWITCH B895-07-005</p>	<p>2</p>
	<p>CANOPY FAN TYPE R2E225-AG01-21 (230V, 0.88AMP, 200W) B869-75-026</p>	<p>3</p>
	<p>2 POSITION SELECTOR B801-12-011</p>	<p>4</p>
	<p>CONTACT BLOCK B801-14-005</p>	<p>5</p>

DX UK Modular MK2 Deck Oven Interlink Detail

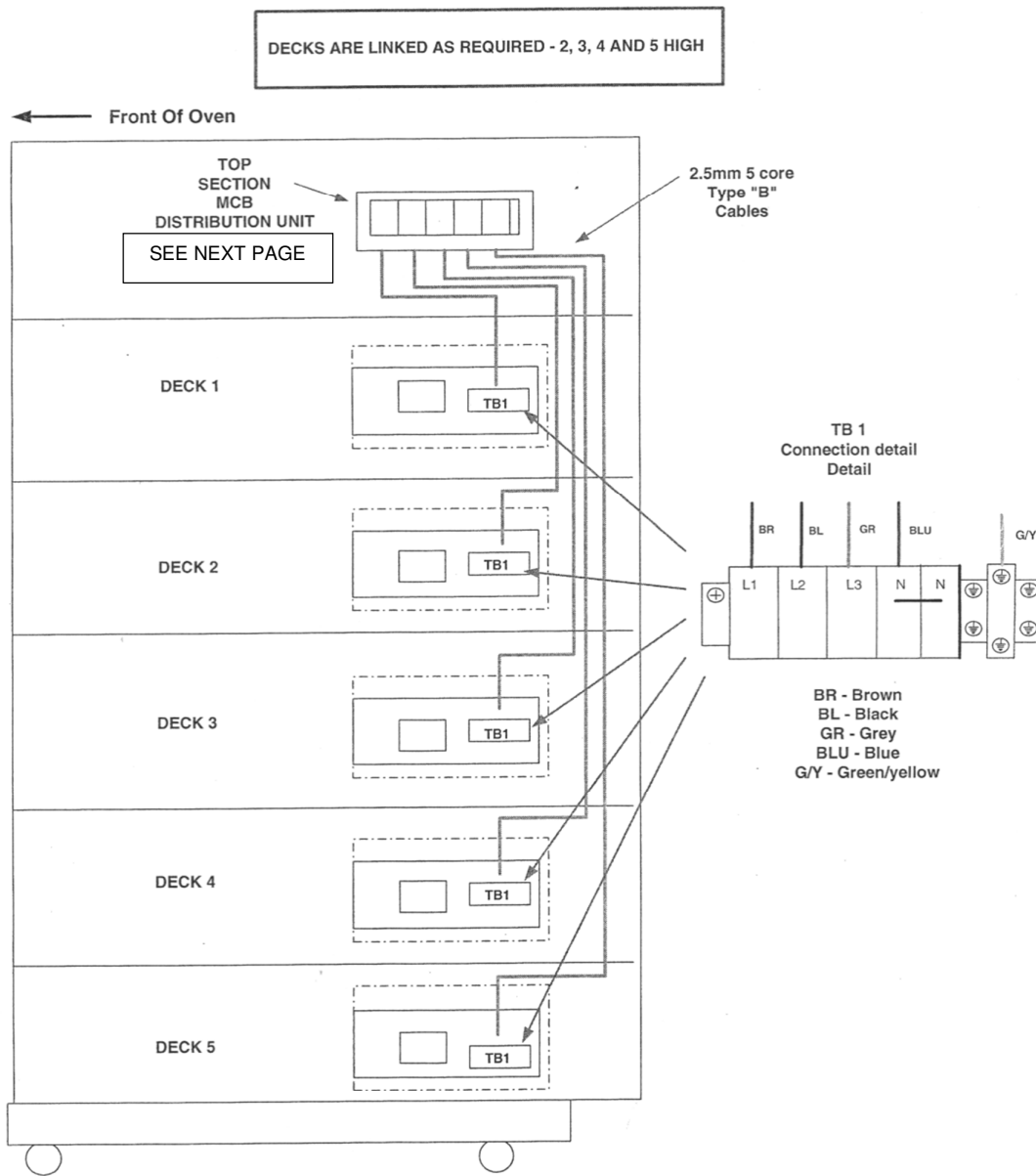

 MONO EQUIPMENT ORDERED BY SWANGLA WEST RD PARK SWANSEA SA6 4EB TEL: (01792) 561234 FAX: (01792) 561016 Email: engineering@monoequip.com	TITLE: UK/EUROPE MODULAR MK 2 DECK OVEN INTERLINK DETAIL		
	ELECTRICAL SPECIFICATIONS: 400V 50/60 HZ 3 PHASE + N+E	DRAWN: ADT	ELECTRICALLY APPROVED BY: ADT
	DATE: 19-2-07	DRAWING NO. M257E25-52500	REV. -

TOP CANOPY MK 2 DECK OVEN MCB WIRING

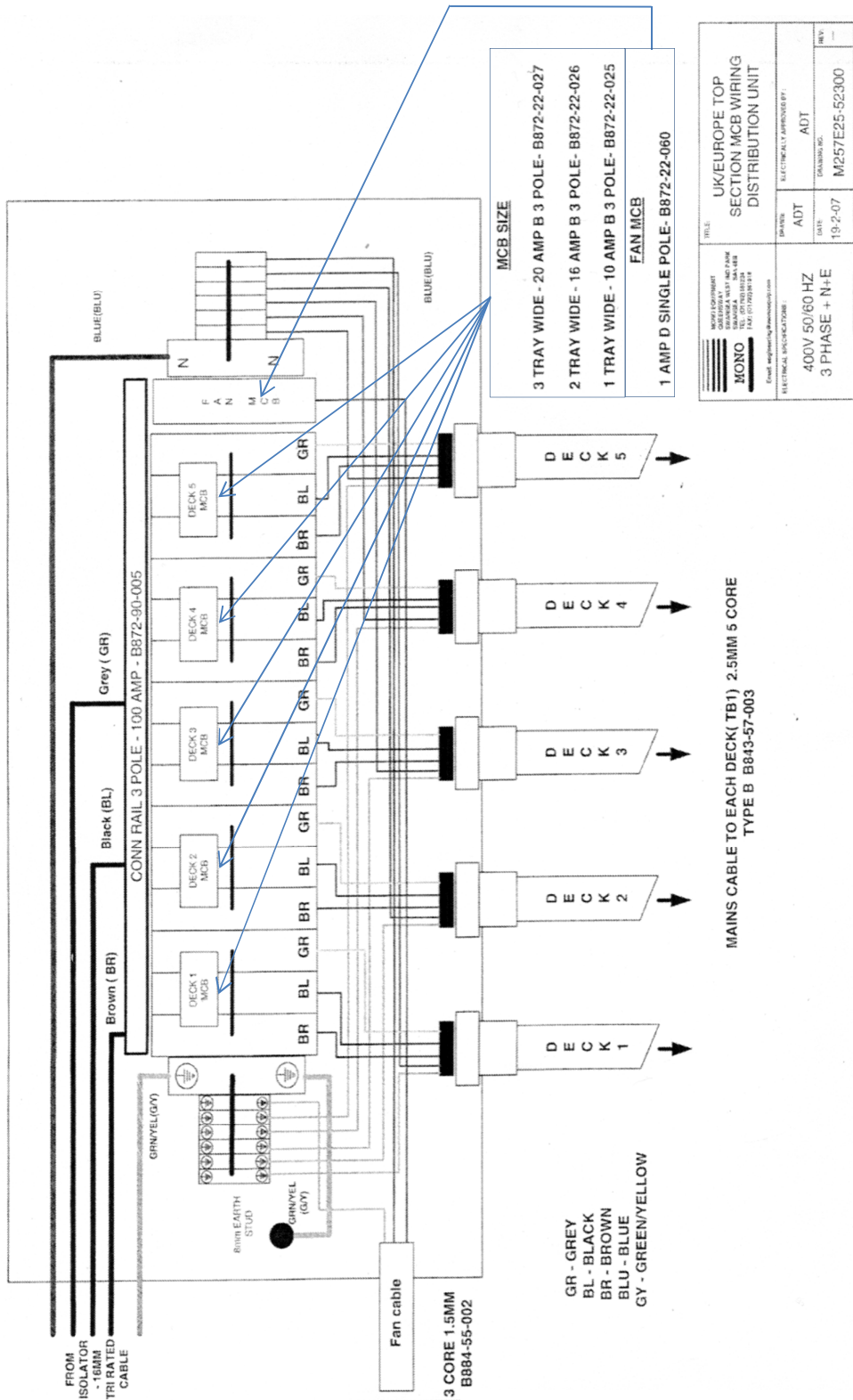

IF IN ANY DOUBT - ASK

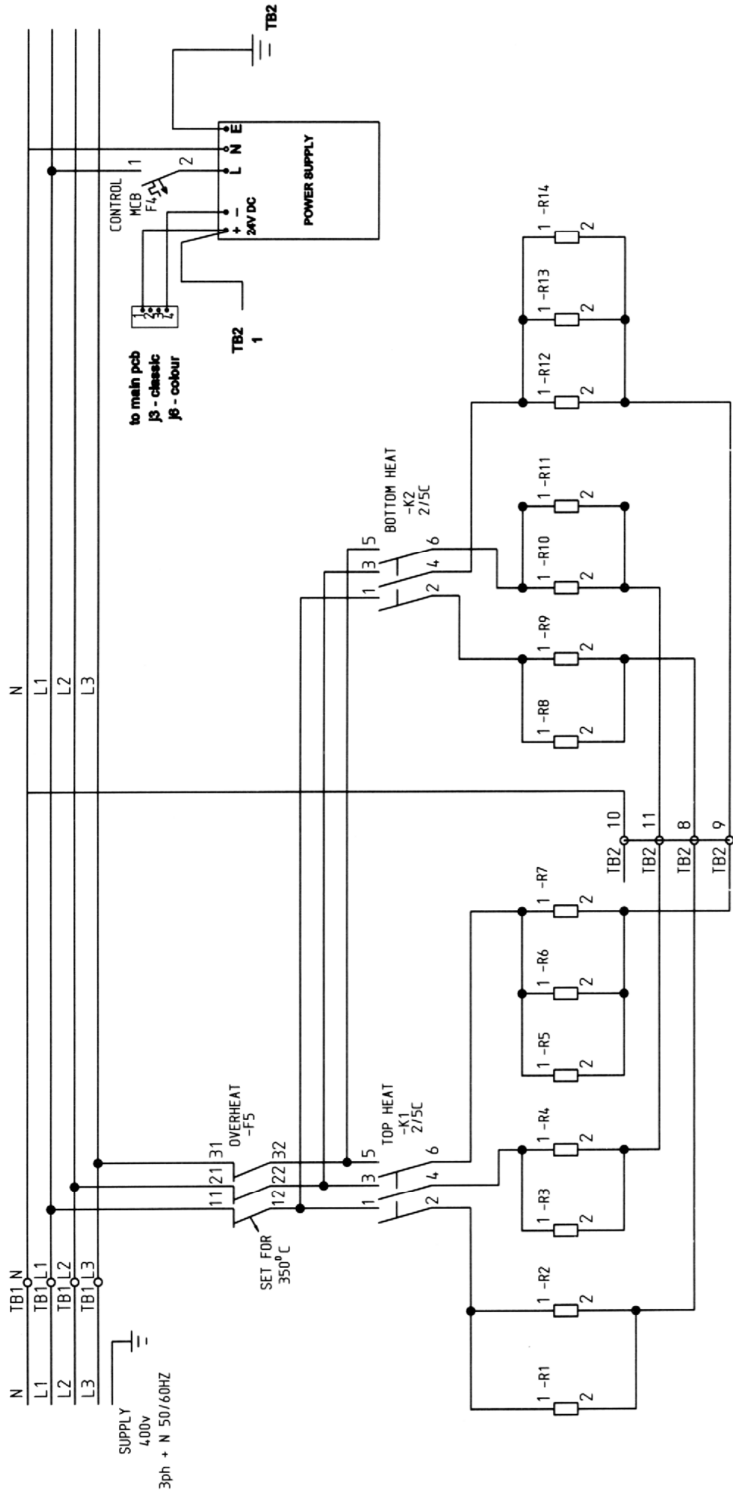

REV	SIG	DATE	REVISION	ECN NO.
<p>MIND EQUIPMENT QUEENSWAY SWANSEA WEST IND PARK SWANSEA, SA5 4EB. TEL: (01792) 561234 FAX: (01792) 561016</p>				
<p>TITLE: MODULAR DECK OVEN POWER CIRCUIT TOP-BOTTOM HEAT</p>				
<p>UK</p>				
<p>DRAWN: RAC ELECTRICALLY APPROVED BY:- AT</p>				
<p>ELECTRICAL SPECIFICATIONS:- 400V 3PH & N + E 50/60 HZ</p>				
<p>DATE: 7/3/07 DRAWING NO: M257E25-30000 REV: 1</p>				

COPYRIGHT © 1998 - THIS DESIGN/DRAWING IS THE PROPERTY OF MIND EQUIPMENT LTD. AND MUST NOT BE REPRODUCED, COPIED, NOR ITS CONTENTS DIVULGED WITHOUT PRIOR WRITTEN PERMISSION.

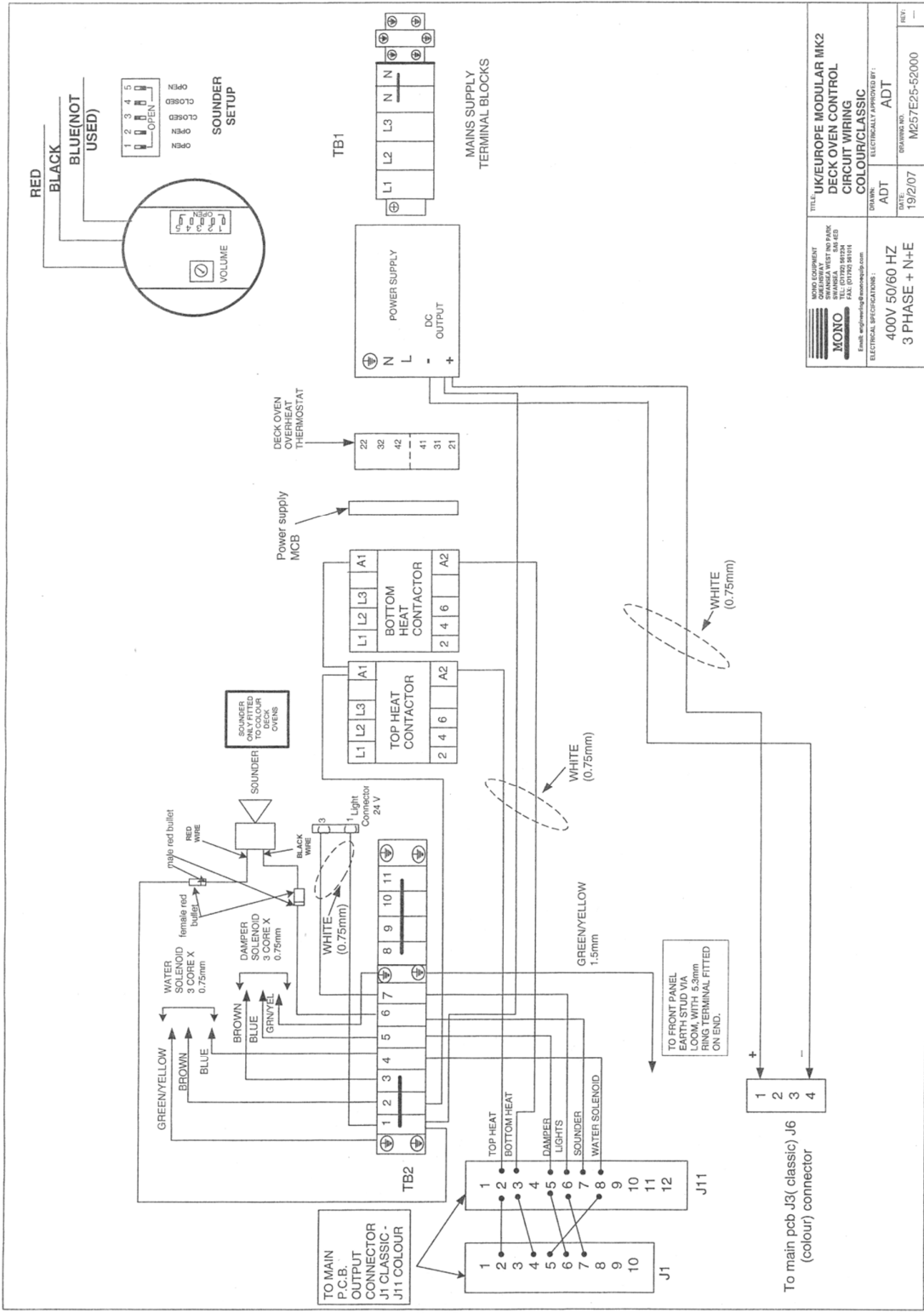

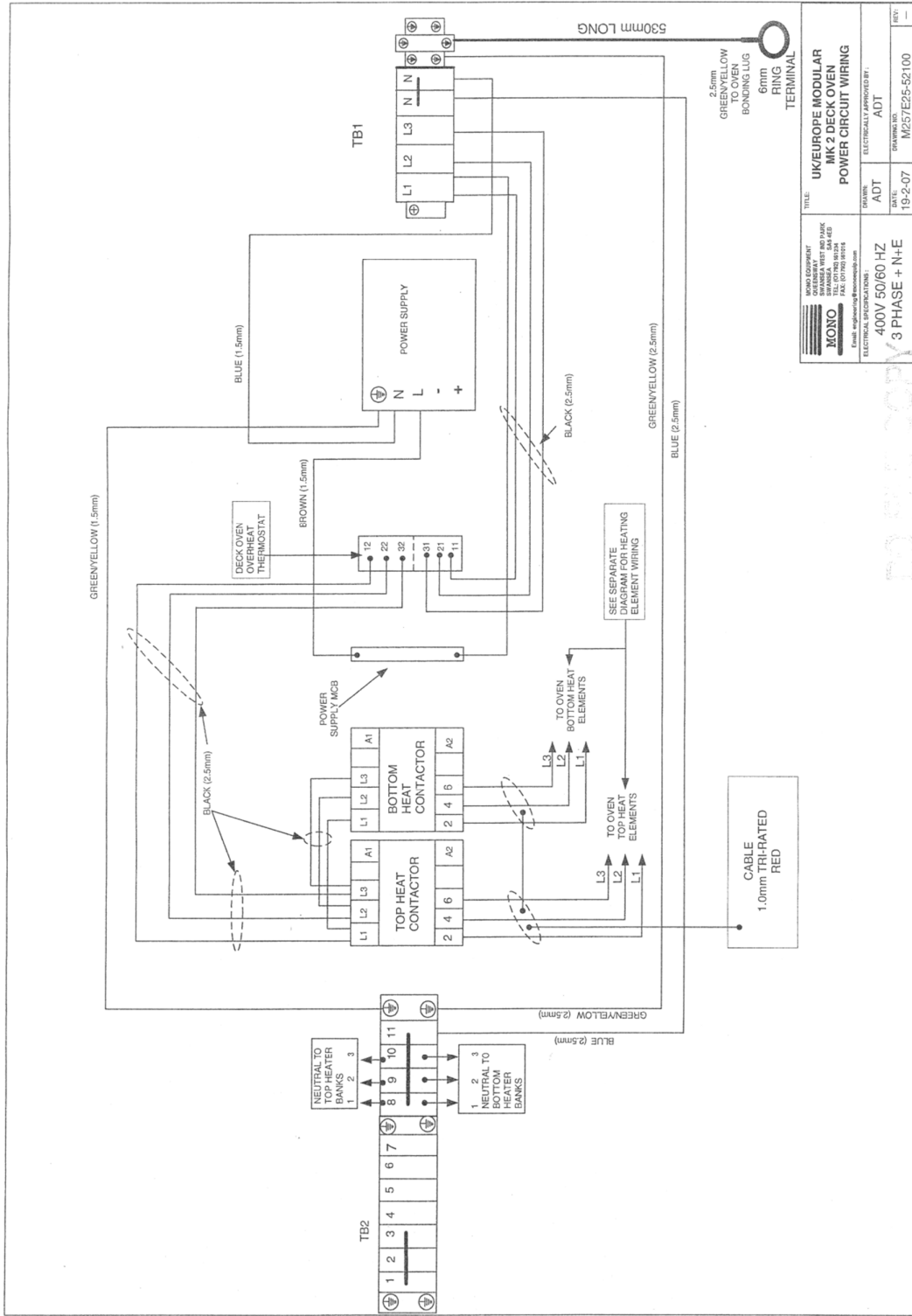

 MOMO EQUIPMENT 1000/1000 WEST 800 ROAD BRANDBURG, KY 40309 TEL: (502) 784-1100 FAX: (502) 784-1101 Email: engineering@momoequipment.com	TITLE: UK/EUROPE MODULAR MK 2 DECK OVEN POWER CIRCUIT WIRING	
	DRAWN BY: ADT ELECTRICALLY APPROVED BY:	DATE: 19-2-07 DRAWING NO: M257E25-52100
ELECTRICAL SPECIFICATIONS: 400V 50/60 HZ 3 PHASE + N+E		

TO OVEN COPY

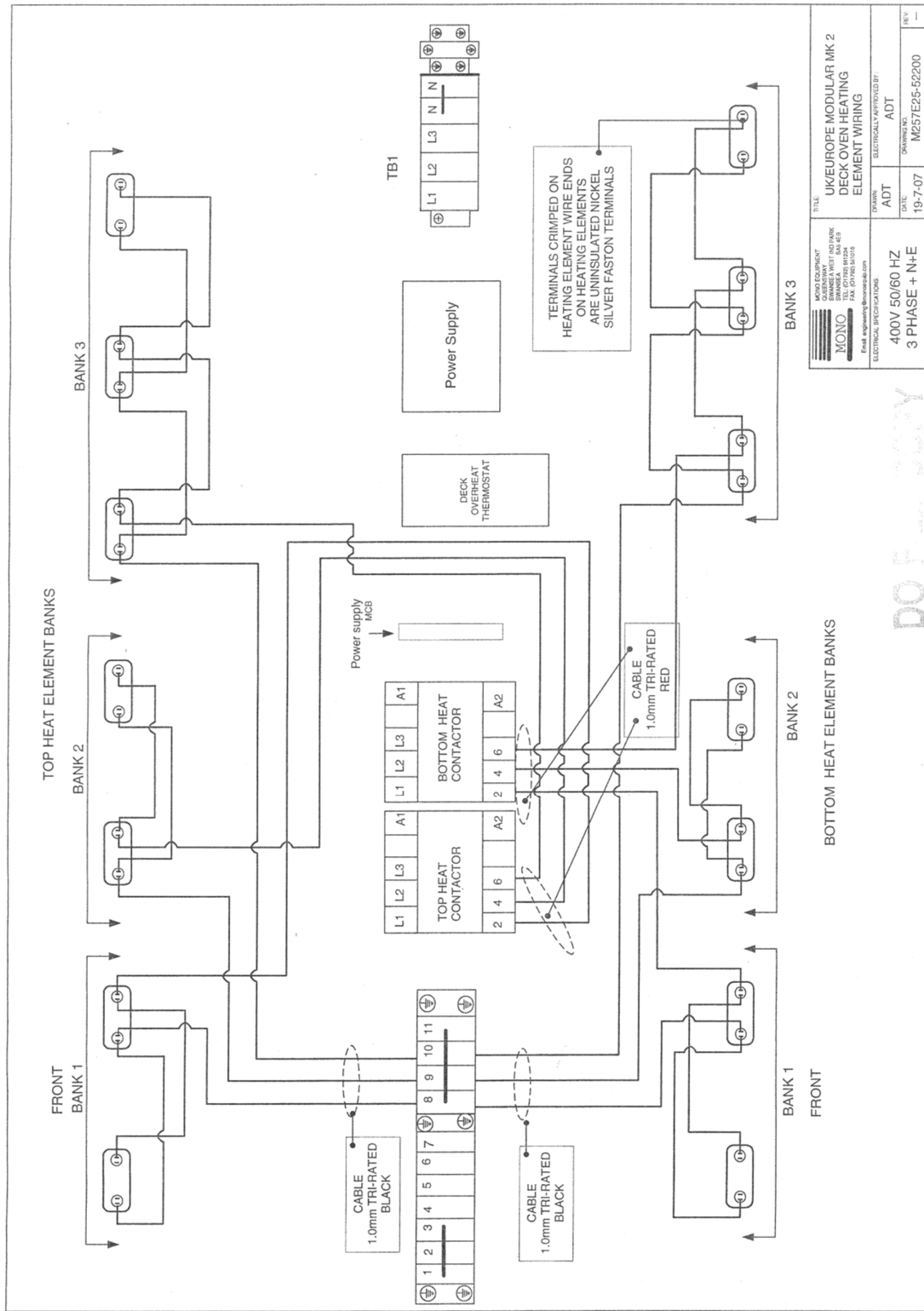

MODULAR DECK MK 2 MAIN ISOLATOR WIRING

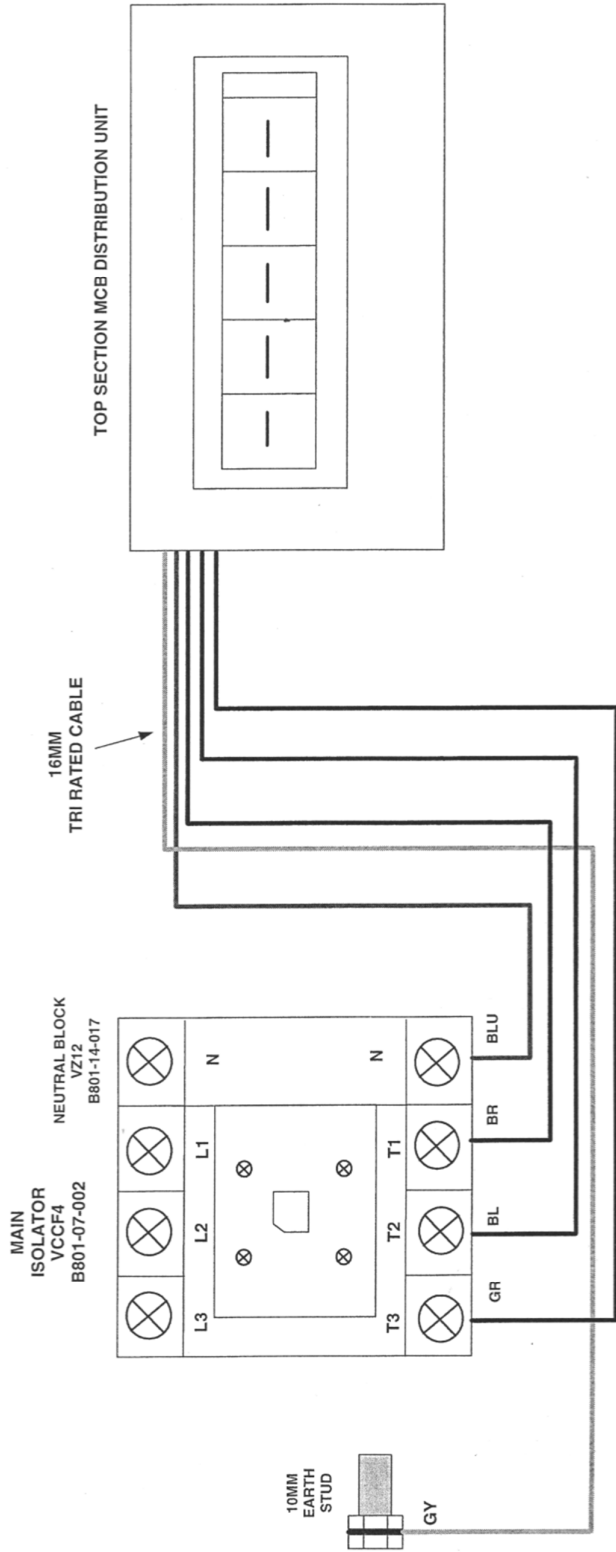

<p>MONO <small>Elect. engineering & technology</small></p>	<p><small>WORLD EQUIPMENT</small> <small>ORLANDO AVENUE UNIT 100 PARK</small> <small>BRISBANE QLD 4101</small> <small>TEL: (07) 7521 8114</small></p>	<p>TITLE UK/EUROPE MODULAR MK 2 DECK OVEN ISOLATOR WIRING</p>
	<p><small>ELECTRICALLY APPROVED BY:</small> ADT</p>	<p><small>DRAWING NO.</small> M257E25-52400</p>
<p>ELECTRICAL SPECIFICATIONS: 400V 50/60 HZ 3 PHASE + N+E</p>	<p><small>DATE:</small> 19-2-07</p>	<p><small>REV:</small> —</p>