

# Semi-automatic frame slicers

# MODENA+

- ✓ Robust
- ✓ Sleek lines
- ✓ Progressive traction lever for optimum effort control
- ✓ Silent
- ✓ Good ergonomics

Up to 200 loaves an hour

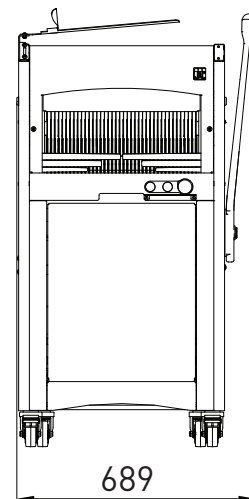
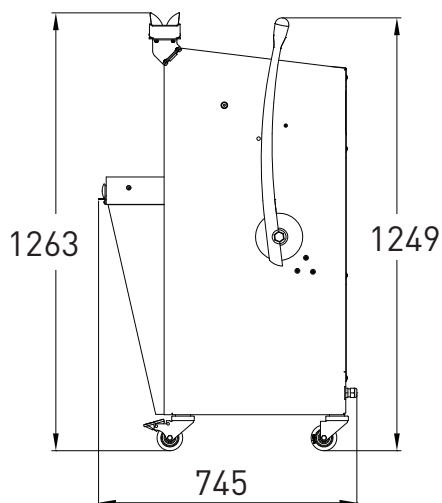



**Progressive traction lever**  
Controls effort more effectively.



**Removable crumb collector**  
Accessible by tilting the front, cylinder-assisted door. 18 litre capacity.



**JAC FLAPS**  
Holds the loaf together for easier handling at the exit of the machine.

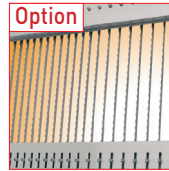

Option

**Double slice thickness**  
Allows two different slicing widths on the same machine



Option

**Daily adding counter**  
Tells the user how many loaves have been cut for maintenance interval monitoring purposes.



Option

**4cm height adjustment**  
Increases working comfort for tall operators.



**Type available**  
"M" system

Micronised knife lubrication system for cutting bread with a high rye content or sticky crumb. Developed by JAC, it consumes the least possible amount of oil (120 ml per 1000 loaves) and produces a consistent cutting quality.

## FEATURES

	MODENA+ 450	MODENA+ 450M 
Max. loaf dimensions in cm (L x W x H)	44 x 30 x 16	44 x 29 x 16
Motor power in kW	0.49	1.5
Net weight (in kg)	165	175
Blade type and dimensions in mm	13 x 0.5 steel	13 x 0.5 Teflon coated
Daily adding counter		•

## CHOICES

Slice thickness in mm	9 - 18	9 - 12
Loaf pusher height	Extra low (50mm) Low (80mm) High (100m)	Misch (80mm)
Type of motor	230V single phase 230V three-phase 400V three-phase	400V three-phase
Standard colour*	•	•

## OPTIONS

Heavy duty motor	•	
4cm height adjustment	•	•
Double slice thickness	•	
Daily adding counter	•	
Special colour	•	•
Special blades	•	

\*STANDARD COLOURS

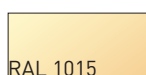

RAL 1015

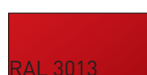

RAL 3013



RAL 9005

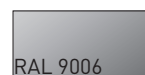

RAL 9006

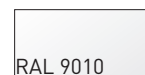

RAL 9010