

[www.monoequip.com](http://www.monoequip.com)

Enter **Serial No.** here. \_\_\_\_\_

In the event of an enquiry please quote this serial number.



## OPERATING AND MAINTENANCE MANUAL

# COMPACT

SERIES

## 643 3 TRAY OVEN

FILE 52

**To conserve heat do not keep door open longer than needed.**

# **ATTENTION**

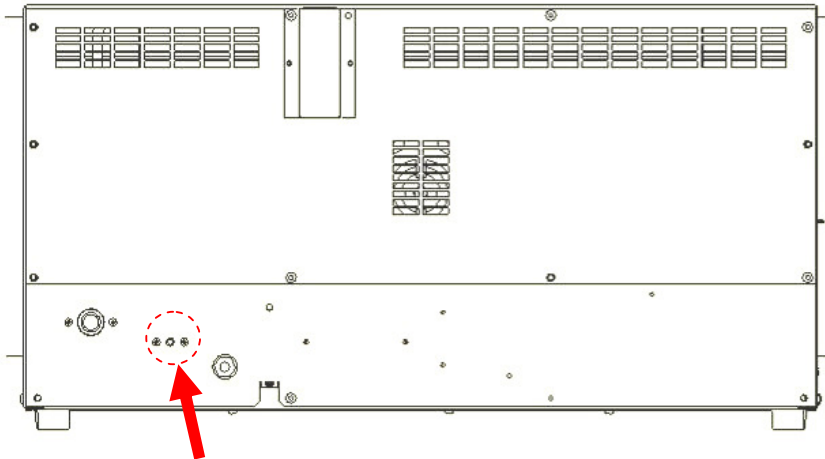

**IF OVEN FAILS TO HEAT UP, WHEN FIRST CONNECTED TO A POWER SUPPLY OR DURING USE AT ANYTIME, PRESS RESET BUTTON LOCATED THROUGH THE REAR BACK PANEL. (DO NOT REMOVE BACK PANEL)**

---

## **SAFETY SYMBOLS**

The following safety symbols are used throughout this product documentation and manual (available at [www.monoequip.com](http://www.monoequip.com)).

Before using your new equipment, read the instruction manual carefully and pay special attention to information marked with the following symbols.



### **WARNING**

Indicates a hazardous situation which, if not avoided, will result in death or serious injury.



### **WARNING**

Indicates a hazardous situation which, if not avoided, will result in electric shock.



### **CAUTION**

Indicates a hazardous situation which, if not avoided, will result in minor or moderate injury.

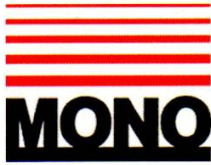

## DECLARATION OF CONFORMITY

We hereby declare that this machine complies with the essential health and safety requirements of :-

- The Machinery Directive 2006 / 42 / EC
- The Low voltage Directive 2014 / 35/ EC
- The requirements of the Electromagnetic Compatibility Directive 2004 / 108EC, 91 / 263 / EEC, 92 / 31 / EEC  
Incorporating standards  
EN55014-1:2006+A1:2009+A2:2011  
EN55014-2:1997+A1:2001+A2:2008
- The General Safety of Machinery and food processing Standards applicable
- Materials and Articles intended to come into contact with food Regulation (EC) No. 1935 / 2004

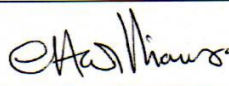
<b>Signed</b>	
G.A. Williams – Quality Manager	

<b>Date</b>	
-------------	--

<b>Machine FG Code.</b>		<b>Machine Serial No.</b>	
-----------------------------	--	-------------------------------	--

A technical construction file for this machine is retained at the following address:

**MONO EQUIPMENT**  
Queensway,  
Swansea West Industrial Park,  
Swansea  
SA5 4EB  
UK

**MONO EQUIPMENT** is a business name of **AFE GROUP Ltd**  
Registered in England No.3872673 VAT registration No.923428136

Registered office: Unit 9, Bryggen Road,  
North Lynn Industrial Estate,  
Kings Lynn,  
Norfolk,  
PE30 2HZ

# CONTENTS

---

**PART 1.0 Introduction**

**PART 2.0 Dimensions**

**PART 3.0 Specifications**

**PART 4.0 Safety**

**PART 5.0 Installation**

**PART 6.0 Isolation**

**PART 7.0 Cleaning Instructions**

**PART 8.0 Operating Conditions**

**PART 9.0 Operation Instructions**

**PART 10.0 Maintenance**

**PART 11.0 Steam System Maintenance**

**PART 12.0 Bulb Replacement**

**PART 13.0 Spares Information**

**PART 14.0 Electrical Information**

# 1.0 INTRODUCTION

---

## The MONO 643 COMPACT oven

is a compact, electric oven with a capacity for three 60cm x 40cm baking trays.

- The oven is robustly made of **stainless steel** with a bake chamber shaped to allow the unit to be **easily cleaned**.
- It has very high levels of **insulation for safety** and to **help save energy**.
- A great deal of attention has been given to keeping the **front areas cool**.
- It has an exceptionally **easy to operate** control panel that will save up to nine programs.
- **MONO COMPACT** is designed to be **stackable**, without the requirement for a separate support and will grow with your business without occupying a large area of your valuable retailing space.

# 2.0 DIMENSIONS

---

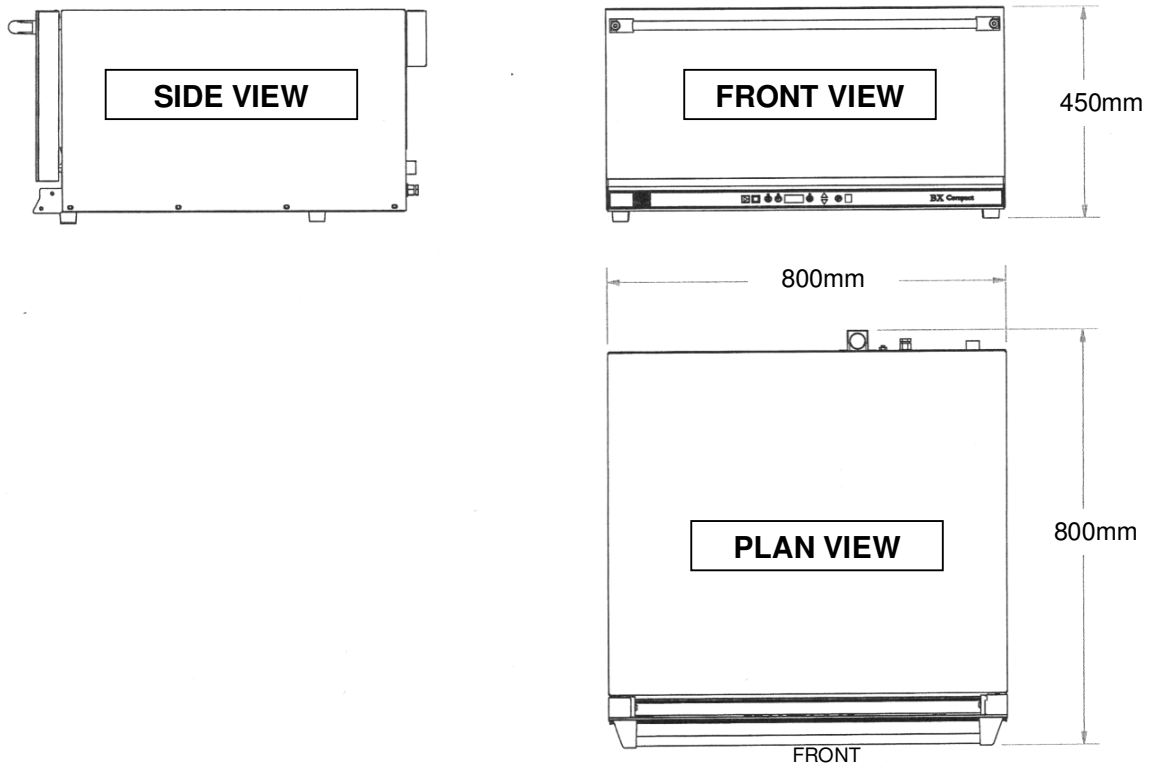

## 2.1 OUTER DIMENSIONS

<b>Height:</b>	<b>450mm.</b>
<b>Depth, door closed:</b>	<b>800mm.</b>
Depth, door open:	1065.
<b>Width:</b>	<b>800mm.</b>

### **Operational clearance:**

50mm (2") clearance is required at the back and sides of the oven and 250mm (10") above to allow adequate circulation of air.

## 3.0 SPECIFICATIONS

---

<b>Total Power:</b>	<b>2.7 kW.</b>
Electric Supply:	Single-phase 50Hz fused at 13A.
Supply Cable:	2 metres of cable supplied.



The supply to this machine must be protected by a **30mA RCD**

Water connection	$\frac{3}{4}$ " B.S.P. and should be at a pressure of 2 bar to 4 bar. (normal domestic water supply is usually within these limits).
------------------	---

---

Maximum bake temperature	250 degrees C
Maximum bake time	99 Minutes
Maximum steam time	20 seconds

Maximum number of programs 9

---

Noise Level: Less than 85dB.

---

**WEIGHT**                      **55KG**

## 4.0 SAFETY

---

***In the interest of safety and efficient operation of this oven, it is essential that this manual should be made available to the operator before work is commenced. The following points should be closely observed and rigorously pursued at all times.***

To safely use this convection oven, read this owner manual completely and follow the warnings below, as well as all other warnings in this manual.

- The oven is designed for the baking of bread, confectionery and savory products. Do not use it for baking other items without first consulting the supplier.



- All repairs and maintenance of electrical units must only be carried out by an authorized service technician.



- Electrical access panels must not be opened except by an authorized service technician and the oven power cord must be unplugged.



- While the oven is in operation, and for some time after use, DO NOT TOUCH the oven window and surrounding area as these surfaces may be hot.

- The oven must be operated as described in this manual.
- Authorized service technicians should only use original manufacturer spare parts on the oven.
- The construction of the oven must not be changed or altered.
- This appliance must be disconnected from the power supply before moving or cleaning/servicing.
- Check for frayed or bare cables.  
The machine must not be used if frayed or bare cables are visible.



- Oven gloves should be worn when moving products in or out of the oven.
- Unless trays/containers for the purpose of holding the oven products are supplied with the oven by the manufacturer, it is the responsibility of the customer to ensure that the nature and surface conditions of materials likely to come into contact with food shall be such that they cannot contaminate or spoil the food.

## 5.0 INSTALLATION

---

The supply to this machine must be protected by a **30mA RCD**



- **CAUTION** Because of the weight, lifting the oven should not be attempted by one person.
  - Ensure that the oven base is level or a level working height surface capable of supporting at least 100kg is used
  - The **COMPACT oven** should be connected to a local means of isolation.
  - Operational clearance of 50mm (2") is required at back and sides of oven and 250mm (10") top clearance to allow circulation of air.
  - In the interests of hygiene, before using the oven for the first time, we strongly recommend that you wipe the inside of your oven and all accessories thoroughly with a clean cloth soaked in warm soapy water. Although the utmost care is taken during assembly and pre-delivery inspection, there is always a possibility of residue contaminating your first bake if this is not done.

### DISPOSAL

Care should be taken when the machine comes to the end of its working life. all parts should be disposed of in the appropriate place, either by recycling or other means of disposal that complies with local regulations.

(in UK, "environmental protection act 1990" applies)

## 6.0 ISOLATION

---

**To stop the oven in an emergency,  
unplug or switch off at the wall isolator.**



## 7.0 CLEANING INSTRUCTIONS



**NOTE: BEFORE CLEANING,  
ISOLATE OVEN FROM MAINS SUPPLY AND ALLOW TO COOL.**

### **IMPORTANT**

**NEVER SPRAY THE OVEN WITH A HOSE OR HIGH PRESSURE WASHING DEVICE. TO AVOID ELECTROCUTION OR OVEN DAMAGE –NEVER ALLOW WATER, STEAM, CLEANING SOLUTION, OR OTHER LIQUIDS TO ENTER THE ELECTRICAL PANELS OR CONNECTIONS.**

- The equipment is to be cleaned daily using a solution of mild detergent and hot water.
- Remove the tray racks by unscrewing the fixing knob at the front and lifting the rack up slightly to disengage the back locator. Withdraw the racks and wipe over.



TRAY RACK REMOVAL

- Sweep any debris left in the chamber (after it has been allowed to cool) onto trays and remove. Wipe out the chamber with a damp cloth that has been soaked in a solution of mild detergent and hot water. Be careful not to damage the probe on the left hand side at the back.
- With the door open, release the glass retaining clips (one each side). Lift the inner glass and clean both exposed surfaces. Lower the inner glass gently and ensure the clips are engaged both sides.

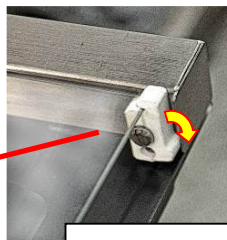

UNCLIP GLASS AND LIFT

- Brush down and wipe outer oven front, back and sides.
- Wipe clean outer oven front, back and sides with a damp cloth that has been soaked in a solution of mild detergent and hot water (do not soak the lower control panel area with water).

## 8.0 OPERATING CONDITIONS ---

- **CAUTION**

Because of the weight, lifting the oven should not be attempted by one person. Ensure that the oven base is level or a level working height surface capable of supporting at least 80kg is used

- For the most efficient operation, the oven should be used in ambient temperatures not exceeding 40°C (115°F). The life of components will be reduced and your warranty will be affected if run above 40°C.
- The ventilation of steam from the oven should be sufficient to ensure water does not condense on or around the oven. Any water ingress could affect your warranty.
- It is the customers' sole responsibility to arrange for adequate ventilation and operational clearance at the back and sides of the oven to allow circulation of air. Refer to Outer dimensions 2.1.

*Any component malfunctioning during the guarantee period that is found to have been subjected to excessive humidity or ambient working temperatures above 40°C (115°F) will not be covered by the component manufactures guarantee, or **MONO's** product warranty.*

# 9.0 OPERATING INSTRUCTIONS

## CONTROL PANEL

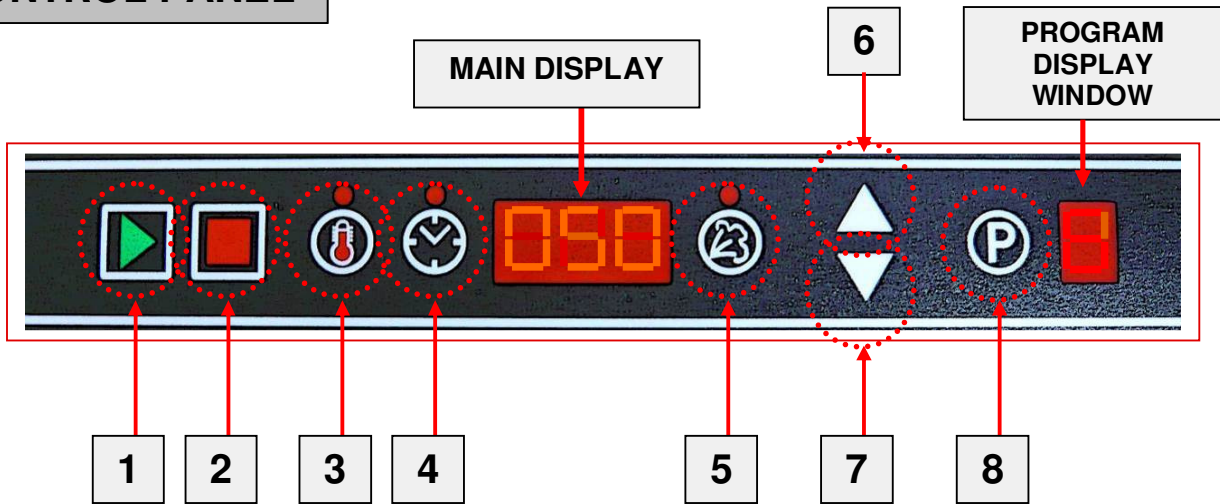

- |   |   |
|---|---|
| <b>1.</b> Start bake button   | <b>5.</b> Set bake <b>steam</b> time button |
| <b>2.</b> <b>Stop</b> bake button<br>To turn oven right off, hold down until a beep is heard. | <b>6.</b> <b>Down</b> button for settings   |
| <b>3.</b> Set bake <b>temperature</b> button  | <b>7.</b> <b>Up</b> button for settings     |
| <b>4.</b> Set bake <b>time</b> button. Up to 99 minutes                                       | <b>8.</b> <b>Program</b> button             |

## TO BAKE USING PRESET PROGRAMS

- Connect power to the oven.  
*Panel will show "OFF" in the main display window.*
- Press start **1** button  
*Temperature will flash in main display.*
- Press up **6** or down **7** buttons to get the program number required.  
*Temperature will flash in main display until the temperature required by the program is reached.*
- When display stops flashing, load the oven and press start. **1**  
*This starts the timer countdown and activates the steam.*

IF THE BARS ON THE MAIN DISPLAY MOVE UPWARDS THE OVEN IS HEATING, IF THEY MOVE DOWNWARDS THE OVEN IS COOLING.



BARS WILL ROTATE IN THE PROGRAM DISPLAY WINDOW WHEN A BAKE PROGRAM IS RUNNING

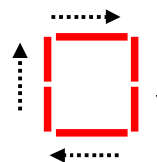

- At the end of the bake a beep will be heard. Press stop **2** to stop.

## **TO SET A BAKE PROGRAM (or MANUAL BAKE)**

### **NOTE**

*If the new settings are to be saved, select the program number to be saved before changing the values then proceed as follows.*

If the new settings are for one bake only (manual bake), proceed as follows:

1. Connect power to the oven.  
*Panel will show "OFF" in the main display window.*
2. Press start  button  
*Temperature will flash in main display.*
3. Press temperature button   
*The set value will show in the main display window and the red dot above the button will illuminate.*
4. Press up  or down  to change the temperature value.
5. **Press temperature button  again to set the value. (or wait a few seconds and the red dot will go out).**
6. Do the same procedure to set time  and steam .
7. If saving the values to a program number, press Program  button for six seconds until a beep is heard. The values chosen are now set to the program number (this will remove any values that were saved to the program number before).

### **NOTE**

*If new settings are not saved, the old settings of the program number showing on the screen will be used the next time the program is chosen.*

8. Load oven and press start.
9. At the end of the bake a beep will be heard. Press stop  to stop.

## TO SET PARAMETERS

1. With the oven in standby (OFF showing in display), press stop  and program  together and hold for about six seconds until a beep is heard.  
*"1" will show in the program display window.*
2. This is the fan forward/reverse time.  
*The time the fan goes in each direction before changing.  
Maximum of 180 seconds.*  
Press up  to increase or  to decrease the time required.
3. Press start  and "2" will show in program display window.  
This allows the settings to be in degrees C or F  
Press up  or  to change.
4. Press start  and "3" will show in program display window.  
This is the "standby delay time setting."  
00 = disabled. Setting can be up to 90 minutes (maximum) in 10 minute increments.
5. Press start  and "4" will show in program display window.  
This shows the latest firmware revision.
6. Press stop  to exit setup and save the parameters.

## 10.0 MAINTENANCE

---

- Check for frayed or bare cables.  
*The machine must not be used if frayed or bare cables are visible.*
- Follow cleaning instructions meticulously.
- There is no special maintenance required.

## 11.0 STEAM SYSTEM MAINTENANCE

---

If it is noticed that the steaming operation has deteriorated, perhaps due to hard water scaling, please contact your oven supplier.

## 12.0 BULB REPLACEMENT

REPLACEMENT BULB = B857-94-007

In the event of a bulb failure, Instructions on how to change a bulb are as follows: -

1. Ensure oven is isolated from mains supply and allow cooling.
2. Remove the left hand tray rack by unscrewing the fixing knob at the front and lifting the rack up slightly to disengage the back locator. (See illustration, section 7.0).
3. Remove the four fixing screws and take glass, frame and gasket off lamp unit.

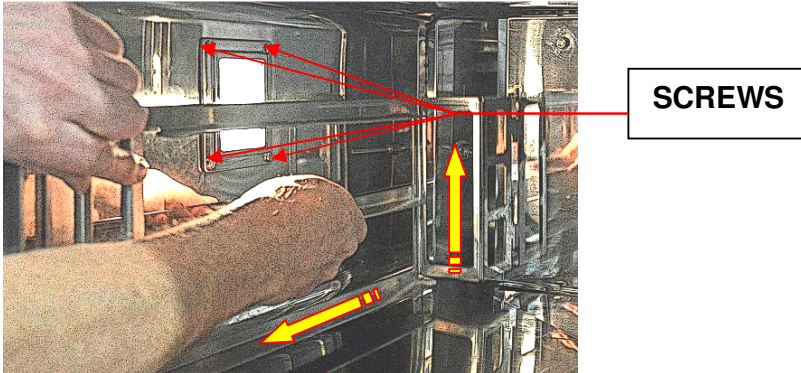

4. Remove the bulb by pulling in the direction of the arrow shown below and replace with a new bulb.

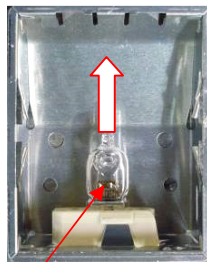

**DO NOT TOUCH NEW BULBS WITH BARE HANDS.**  
USE A CLOTH OR GLOVES TO STOP ANY MARKS THAT WILL CAUSE HOT SPOTS AND PREMATURE BULB FAILURE.

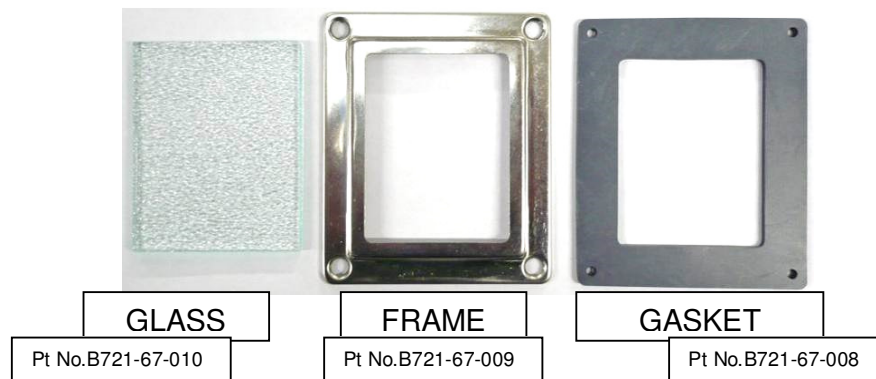

5. Refit glass front, taking care that the gasket is in position around stainless steel frame.
6. Re-connect oven to the power supply and test.



## 13.0 Spares Information

Spares Tel. +44(0)1792 564039  
email:spares@monoequip.com



# REAR MAIN ELECTRICAL PANEL PARTS

RELEASE THE FIXING SCREWS EACH SIDE TO ALLOW EASY ACCESS TO PARTS AS SHOWN

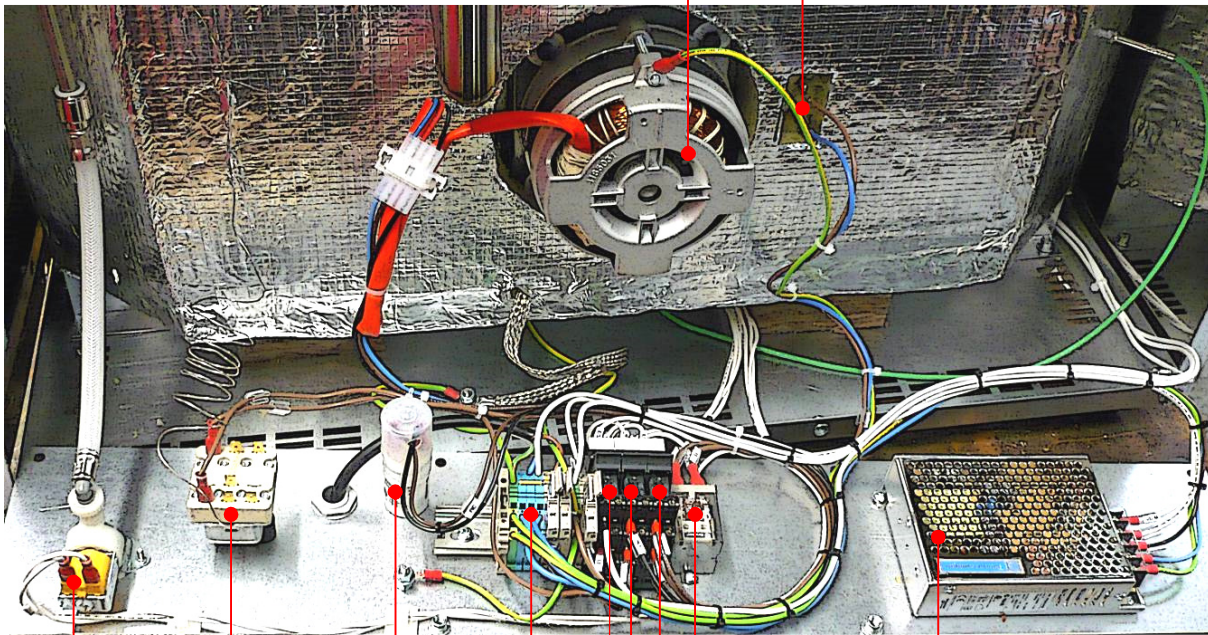

8. FAN UNIT

9. HEATING ELEMENT

1. POWER SUPPLY

2. HEATER RELAY

3. FAN FORWARD RELAY

3. FAN REVERSE RELAY

4. LIGHT RELAY

TERMINAL BLOCKS

MOTOR CAPACITOR (SUPPLIED WITH MOTOR)

5. OVERHEAT THERMOSTAT

6. WATER SOLENIOD

SEE NEXT PAGE FOR PART NUMBERS

## ELECTRICAL PARTS LIST

---

1. POWER SUPPLY	B801-93-005
2. HEATER RELAY	B723-37-001
3. FAN FORWARD RELAY	B723-37-021
3. FAN REVERSE RELAY	B723-37-021
4. LIGHT RELAY	B723-37-021
5. OVERHEAT THERMOSTAT	B888-30-014
6. WATER SOLENIOD	158-17-00400
OVEN CONTROLLER PCB	B705-97-025
8. FAN UNIT	B720-74-004
9. HEATING ELEMENT 230V	B854-04-119
10. CONTROL FUSE	B842-85-039
11. CONTROLLER FUSE	B842-85-013
12. LIGHT FUSE	B842-85-042
TERMINAL BLOCKS - BLUE	B852-50-012
TERMINAL BLOCKS - BEIGE	B852-50-013
TERMINAL BLOCKS - FUSED	B852-39-004
TERMINAL BLOCKS - EARTH	B852-86-005
LAMP UNIT 230V 20W HAL	B721-67-011
DOOR SWITCH ASSEMBLY	148-25-00500
THERMOCOUPLE	B873-95-002
13 AMP PLUG	B835-25-002
LIGHT BULB - HALOGEN	B857-94-007

## NON-ELECTRICAL PARTS LIST

---

TRAY RUNNER FRAME RH	148-01-02301
TRAY RUNNER FRAME LH	148-01-02300
DOOR INNER GLASS ASSEMBLY	148-03-00900
DOOR SEAL	148-03-03400
DOOR HINGE	A900-27-255
DOOR FRONT FABRICATION	148-03-00600

*(OTHER PARTS NEEDED FOR COMPLETE DOOR. PLEASE RING FOR DETAILS)*

**Spares Tel. +44(0)1792 564039**  
**email:spares@monoequip.com**



## 14.0 ELECTRICAL INFORMATION

IF IN ANY DOUBT - ASK

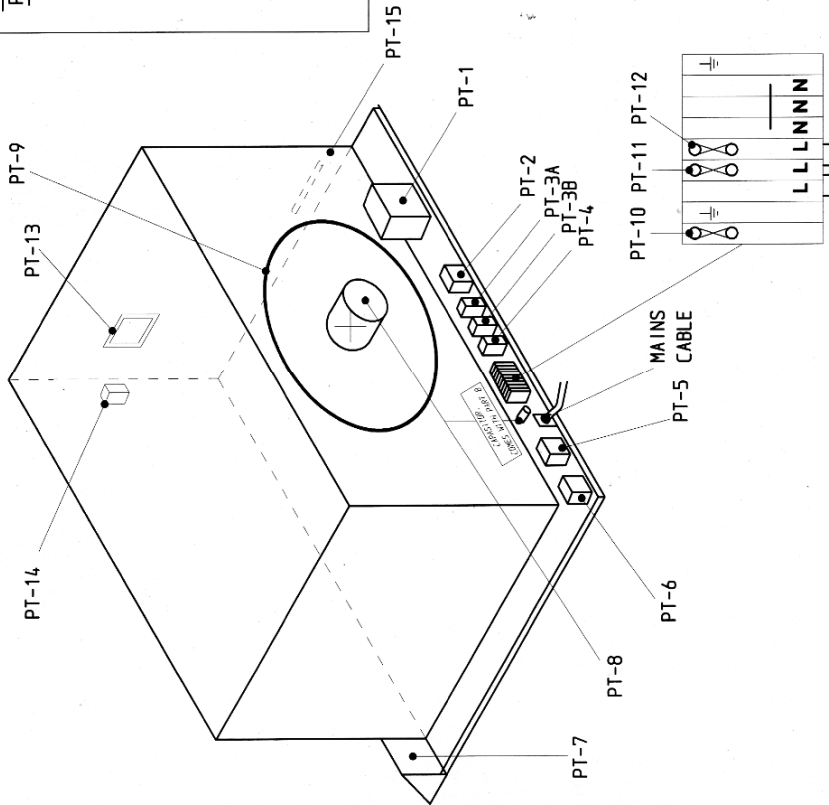

DRAWING PT-Ref	DESCRIPTION	MONO PART NUMBER
PT-1	24V DC POWER SUPPLY	B801-93-005
PT-2	HEATER RELAY	B723-37-001
PT-3A & B	FAN FWD RELY C/W BASE	B723-37-021
PT-4	LIGHT RELAY C/W BASE	B723-37-021
PT-5	OVERHEAT THERMOSTAT	B888-30-014
PT-6	WATER SOLENOID	158-17-00400
PT-7	OVEN CONTROLLER	B705-97-025
PT-8	FAN UNIT	B720-74-004
PT-9	HEATING ELEMENT 230V	B854-04-119
PT-10	CONTROLLER FUSE F3.15	B842-85-013
PT-11	CONTROL FUSE T4	B900-85-009
PT-12	LIGHTS FUSE T8	B842-85-042
PT-13	LAMP UNIT	B721-67-011
PT-14	DOOR SWITCH UNIT	148-25-00500
PT-15	THERMOCOUPLE	B873-95-002

REV	SIG	DATE	ELEMENT WAS	REVISION	ECN NO.
A	JC	17/10/11	BB54-04-117		276/11

<p>MONO EQUIPMENT QUEENSWAY WEST IND PARK SWANSEA SA5 4EB. TEL: (01792) 561234 FAX: (01792) 561016</p>	TITLE: ELECTRICAL COMPONENTS LAYOUT 3 TRAY COMPACT OVEN
ELECTRICAL SPECIFICATIONS:-	DRAWN: RAC
	ELECTRICALLY APPROVED BY:-
	DATE: 11-2-11
	DRAWING NO. M148E25-01000
	REV. A

COPYRIGHT © 1998 - THIS DESIGN/DRAWING IS THE PROPERTY OF MONO EQUIPMENT LTD. AND MUST NOT BE REPRODUCED, COPIED, NOR ITS CONTENTS DIVULGED WITHOUT PRIOR WRITTEN PERMISSION.

**COMPACT BX POWER CIRCUIT WIRING**

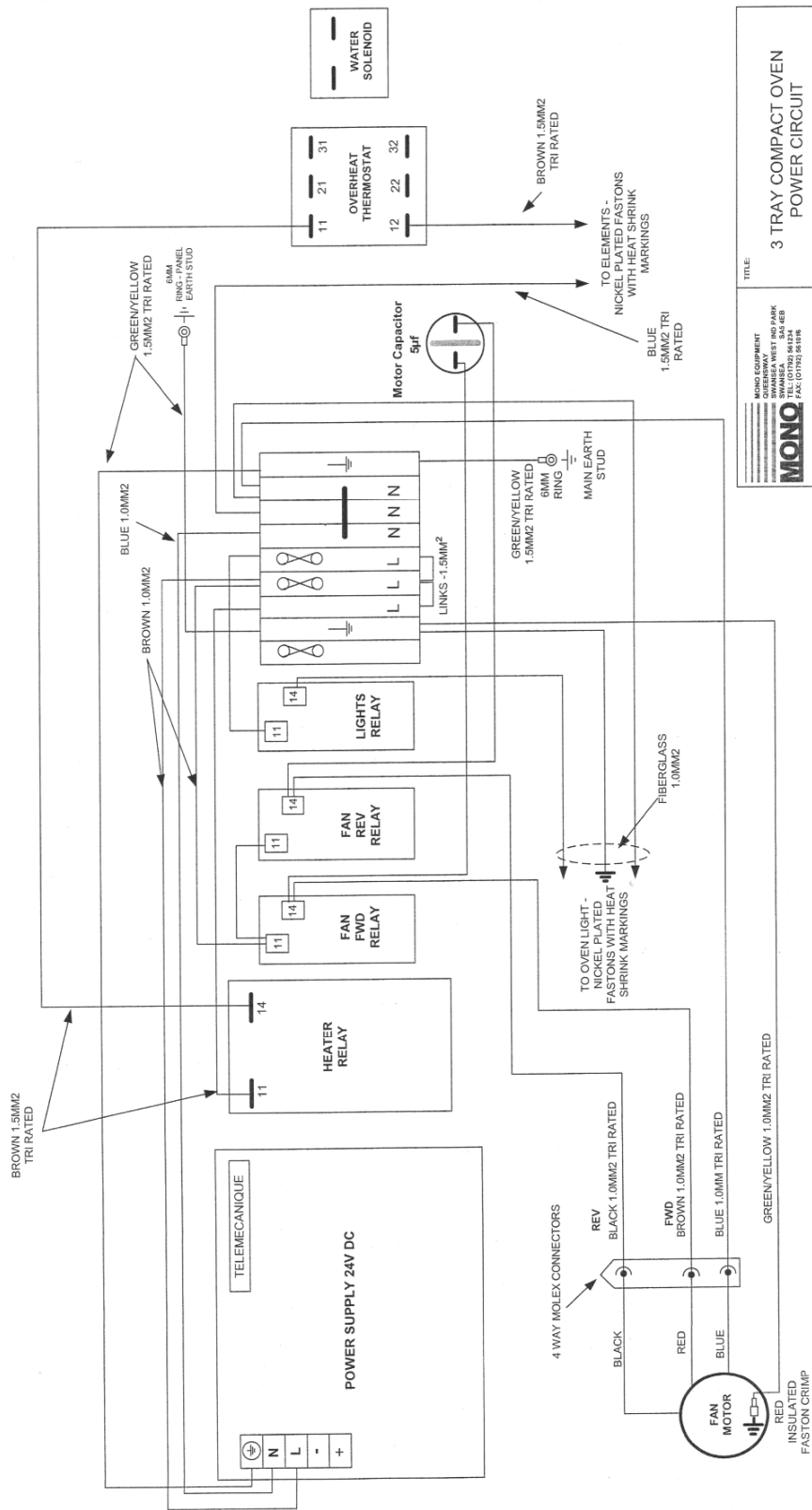

<b>MUNO EQUIPMENT</b> 3000 WILSON ROAD SUITE 100 SHAWNEE, OKLAHOMA 74801 TEL: (405) 275-8100 FAX: (405) 275-8100 <b>MUNO</b> Email: engineering@munoequipment.com		<b>TITLE</b> 3 TRAY COMPACT OVEN POWER CIRCUIT	
<b>DRAWN</b> ADT		ELECTRICALLY APPROVED BY: ADT	
<b>DATE</b> 30/7/10		DRAWING NO. 148E25-00100	
<b>ELECTRICAL SPECIFICATIONS:</b> 240/220 Volt single phase		REV: -	

IF IN ANY DOUBT - ASK

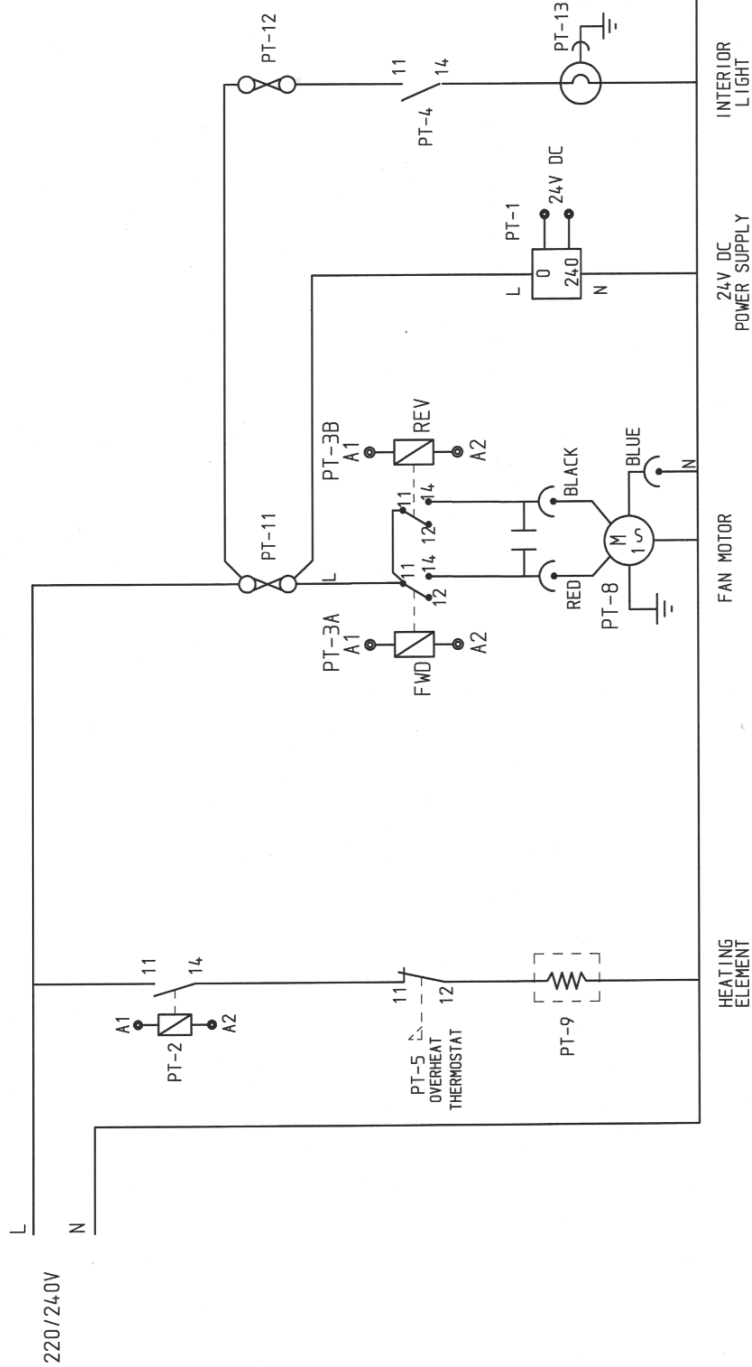

REV	SIG	DATE	REVISION	ECN NO.
<p><b>MONO EQUIPMENT</b>            QUEENSWAY            SWANSEA WEST IND PARK            SWANSEA,            SA5 4EB.            TEL: (01792) 561234            FAX: (01792) 561016</p>				
ELECTRICAL SPECIFICATIONS:-			TITLE:	
220/240V			CONTROL & POWER CIRCUIT DIAGRAM	
1 PHASE			FOR 220/240V 1 PHASE	
			2 WAY FAN	
			DRAWN: A. THOMAS	
			ELECTRICALLY APPROVED BY:-	
			RAC	
			DATE: 21-2-11	
			DRAWING NO. M148E25-01100	
			REV: ---	

COPYRIGHT © 1998 - THIS DESIGN/DRAWING IS THE PROPERTY OF MONO EQUIPMENT LTD. AND MUST NOT BE REPRODUCED, COPIED, NOR ITS CONTENTS DIVULGED WITHOUT PRIOR WRITTEN PERMISSION.

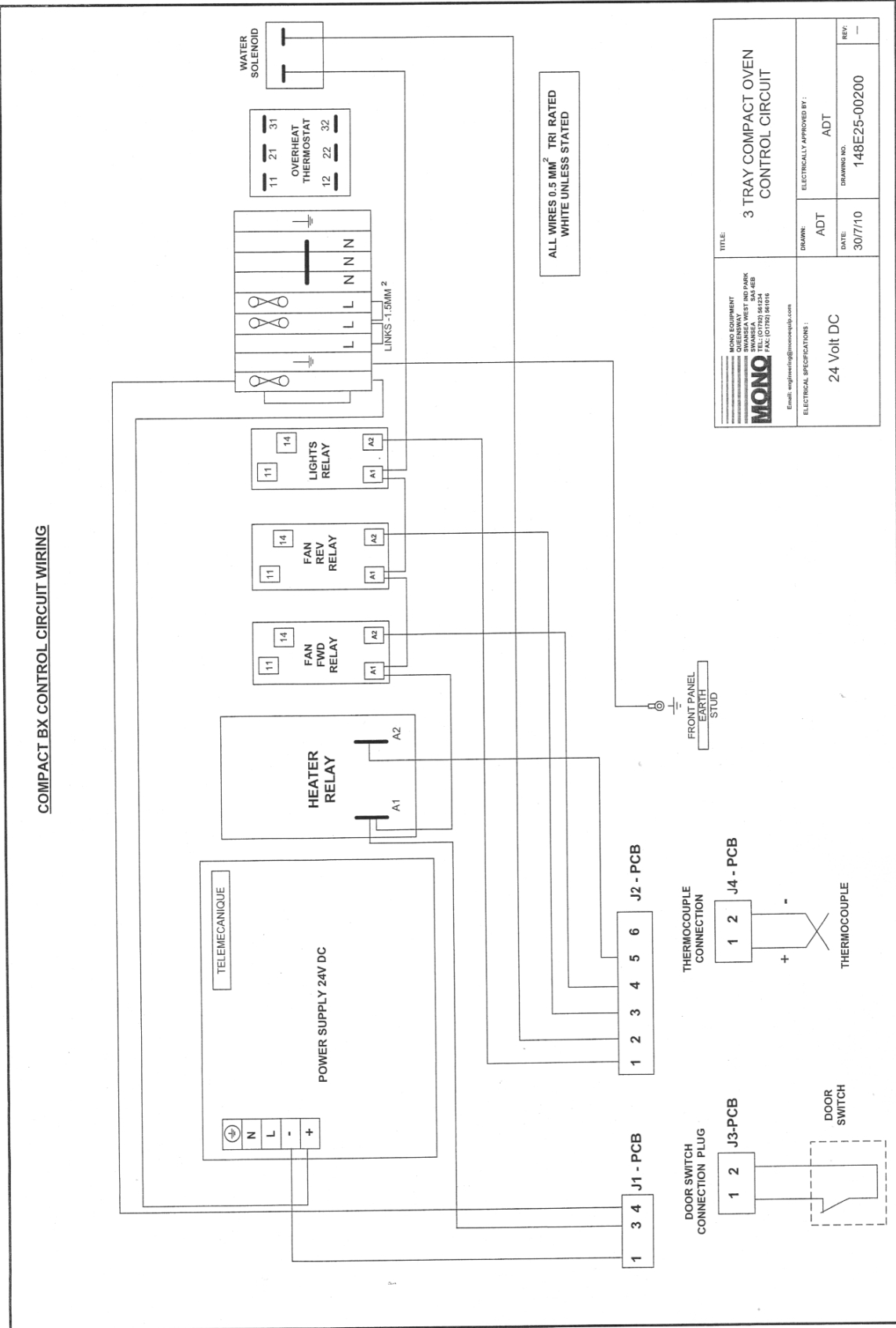

COMPACT BX CONTROL CIRCUIT WIRING

MONO ENGINEERING QUEENSWAY SWANSEA S.A.S. TEL: (07793) 948324 FAX: (07793) 948191 Email: <a href="mailto:enquiries@monoengineer.com">enquiries@monoengineer.com</a>	<b>TITLE</b> 3 TRAY COMPACT OVEN CONTROL CIRCUIT	
	<b>DRAWN:</b> ADT	<b>ELECTRICALLY APPROVED BY:</b> ADT
<b>ELECTRICAL SPECIFICATIONS:</b> 24 Volt DC	<b>DATE:</b> 30/7/10	<b>DRAWING NO:</b> 148E25-00200
		<b>REV:</b> —



COMPACT BX OVEN PCB LAYOUT

FRONT VIEW

SOUNDER

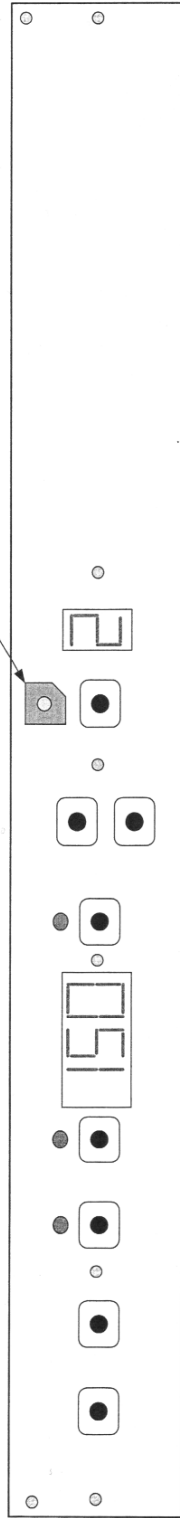

REAR VIEW

24V DC J1 DOOR SWITCH J3 T/C J4 J5

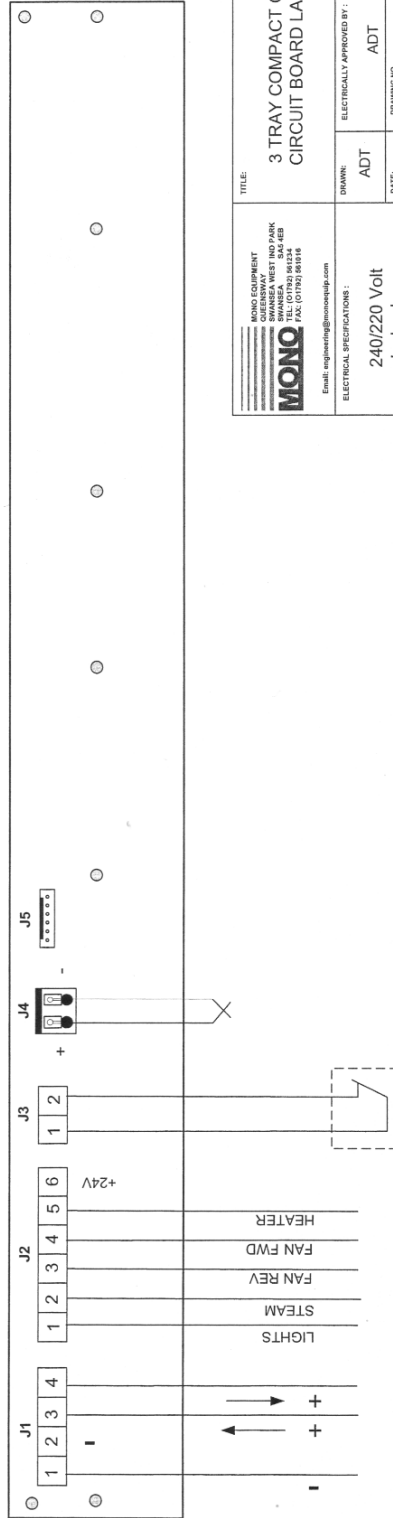

MONO EQUIPMENT MONO WEST 180 PARK SWANSEA WEST WALES SA35 4ES TEL: (01792) 961234 FAX: (01792) 961916 <b>MONO</b> Email: <a href="mailto:engineering@monopip.com">engineering@monopip.com</a>	TITLE:	3 TRAY COMPACT OVEN CIRCUIT BOARD LAYOUT	
	ELECTRICAL SPECIFICATIONS: 240/220 Volt single phase	DRAWN: ADT	ELECTRICALLY APPROVED BY: ADT
	DATE:	30/7/10	DRAWING NO: 148E25-00400
	REV:	-	-

IF IN ANY DOUBT - ASK

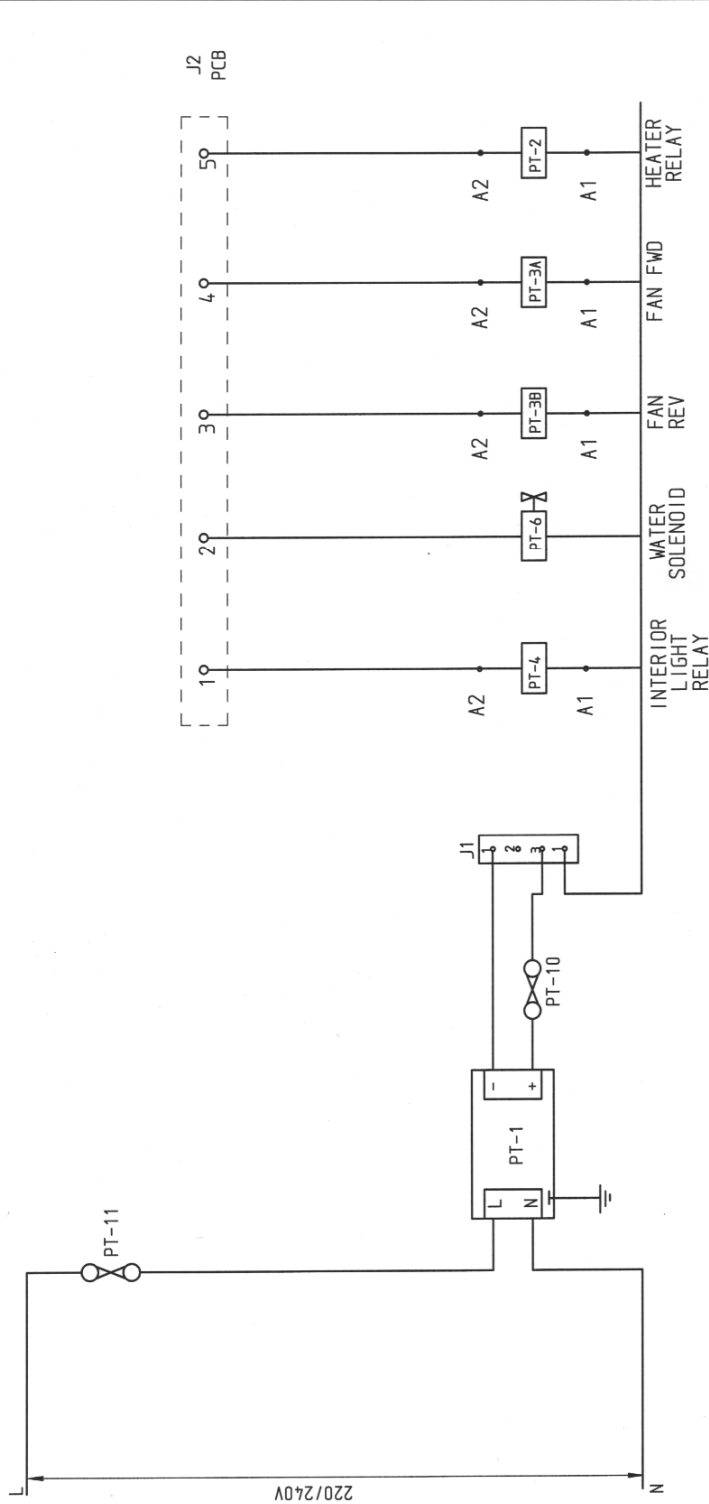

REV	SIG	DATE	REVISION	ECN NO.

<b>MOND EQUIPMENT</b> QUEENSWAY SWANSEA WEST IND PARK SWANSEA, SA5 4EB. TEL: (01782) 561234 FAX: (01782) 561016		TITLE: P.C.B. OUTPUTS COMPACT	
ELECTRICAL SPECIFICATIONS:- 220/240V 1 PHASE		DRAWN: RAC	ELECTRICALLY APPROVED BY:-
		DATE: 21-2-11	DRAWING NO. M148E25-01200
		REV:	REV:

COPYRIGHT © 1998 - THIS DESIGN/DRAWING IS THE PROPERTY OF MOND EQUIPMENT LTD. AND MUST NOT BE REPRODUCED, COPIED, NOR ITS CONTENTS DIVULGED WITHOUT PRIOR WRITTEN PERMISSION.

IF IN ANY DOUBT - ASK

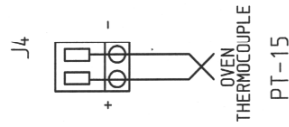
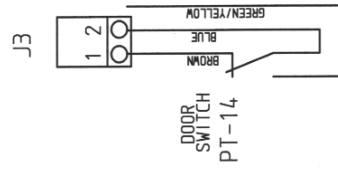

REV	SIG	DATE	REVISION	ECN NO.
		<b>MONO EQUIPMENT</b> QUEENSWAY SWANSEA WEST IND PARK SWANSEA, SA5 4EB. TEL: (01792) 561234 FAX: (01792) 561016	TITLE: P.C.B. INPUTS COMPACT	
ELECTRICAL SPECIFICATIONS:- 220/240V 1 PHASE		DRAWN: RAC	ELECTRICALLY APPROVED BY:- A. THOMAS	
DATE: 21-2-11				REV: -
DRAWING NO. M148E25-01300				

COPYRIGHT © 1998 - THIS DESIGN/DRAWING IS THE PROPERTY OF MONO EQUIPMENT LTD. AND MUST NOT BE REPRODUCED, COPIED, NOR ITS CONTENTS DIVULGED WITHOUT PRIOR WRITTEN PERMISSION.

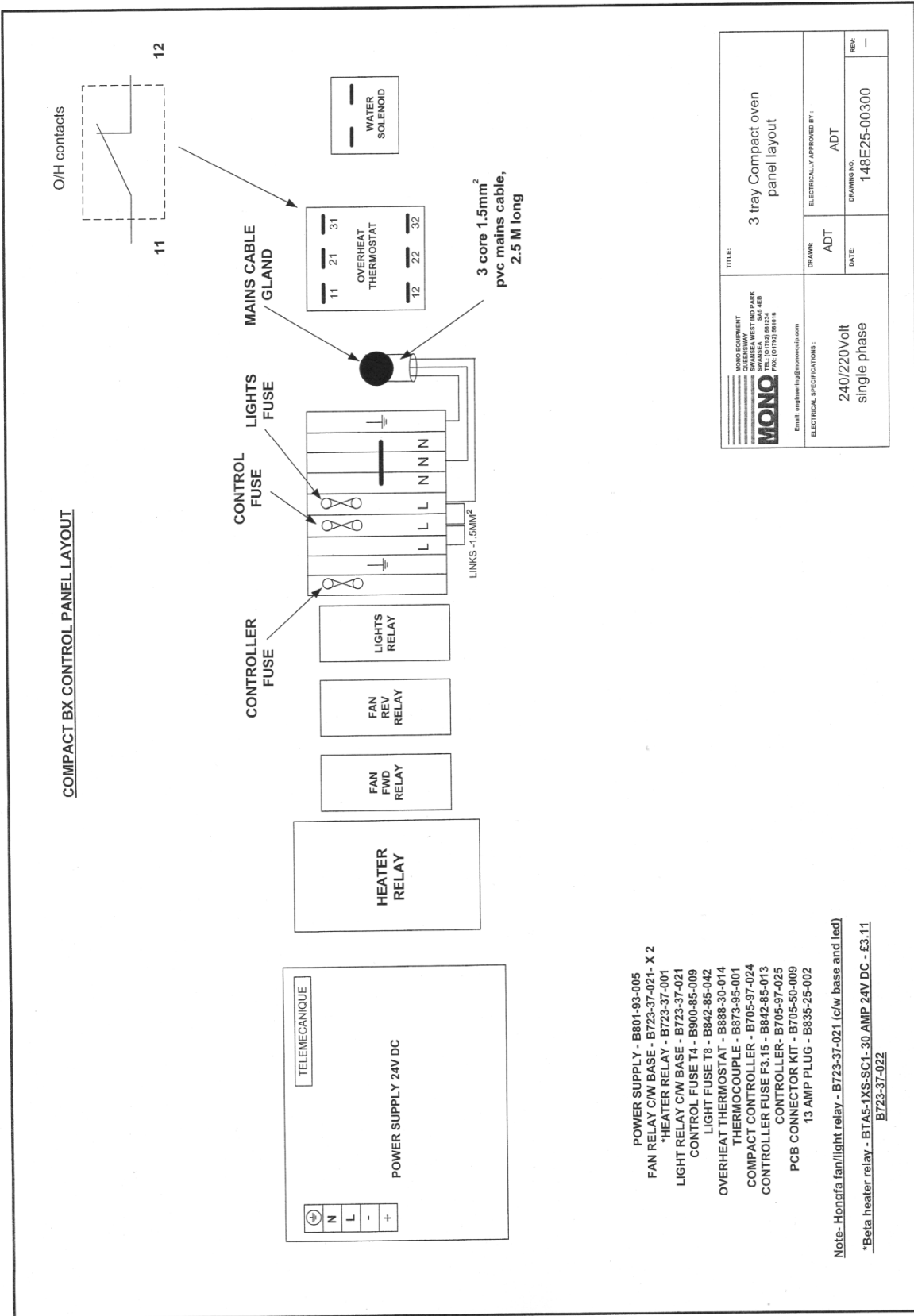

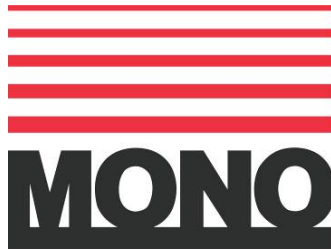

Queensway  
Swansea West Industrial Estate  
Swansea.  
SA5 4EB  
UK

**Tel. +44(0)1792 561234**

**Fax. 01792 561016**

**Web site: [www.monoequip.com](http://www.monoequip.com)**

**Spares Tel. +44(0)1792 564039**  
**email: [spares@monoequip.com](mailto:spares@monoequip.com)**

**□ DISPOSAL**

**CARE SHOULD BE TAKEN WHEN THE MACHINE COMES TO THE END OF ITS WORKING LIFE. ALL PARTS SHOULD  
BE DISPOSED OF IN THE APPROPRIATE PLACE, EITHER BY RECYCLING OR OTHER MEANS OF DISPOSAL THAT**

**COMPLIES WITH LOCAL REGULATIONS.**

**(IN UK, ENVIRONMENTAL PROTECTION ACT 1990 APPLIES)**