

[www.monoequip.com](http://www.monoequip.com)

Enter **Serial No.** here. \_\_\_\_\_

In the event of an enquiry please quote this serial number.



# **Two-Pocket Roll Plant**

## **(With Optional Roll Forming Unit)**

### **User Manual - Master**

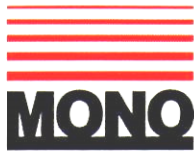

## DECLARATION OF CONFORMITY

We hereby declare that this machine complies with the essential health and safety requirements of :-

- The Machinery Directive 2006 / 42 / EC
- The Low voltage Directive 2006 / 95 / EC
- The requirements of the Electromagnetic Compatibility Directive EN 55014-1:2006 + A1:2009 + A2:2011  
EN 55014-2:1997 + A1:2001 + A2:2008
- The General Safety of Machinery and food processing Standards applicable
- Materials and Articles intended to come into contact with food Regulation (EC) No. 1935 / 2004
- Tested in accordance with BSEN 203-1:2014, BESN203-2-2:2006 and BSEN 203-3:2009
- WRAS certified. Certificate No.1509321

<b>Signed</b>	
G.A.Williams – Quality Manager	

<b>Date</b>	
-------------	--

<b>Machine FG Code.</b>		<b>Machine Serial No.</b>	
-----------------------------	--	-------------------------------	--

A technical construction file for this machine is retained at the following address:

**MONO EQUIPMENT**  
Queensway,  
Swansea West Industrial Park,  
Swansea  
SA5 4EB, UK

**MONO EQUIPMENT** is a business name of **AFE GROUP Ltd**  
Registered in England No.3872673 VAT registration No.923428136

Registered office: Unit 35,  
Bryggen Road, North Lynn Industrial Estate, Kings Lynn Norfolk, PE30 2HZ



## SAFETY SYMBOLS

The following safety symbols are used throughout this product documentation. Before using your new equipment, read the instruction manual carefully and pay special attention to information marked with the following symbols.



### **WARNING**

Indicates a hazardous situation which, if not avoided, will result in death or serious injury.



### **WARNING**

Indicates a hazardous situation which, if not avoided, will result in electric shock.



### **CAUTION**

Indicates a hazardous situation which, if not avoided, will result in minor or moderate injury.

## ELECTRICAL SAFETY AND ADVICE REGARDING SUPPLEMENTARY ELECTRICAL PROTECTION:

Commercial bakeries, kitchens and foodservice areas are environments where electrical appliances may be located close to liquids or operate in and around damp conditions or where restricted movement for installation and service is evident.

The installation and periodic inspection of the appliance should only be undertaken by a qualified, skilled and competent electrician, and connected to the correct supply suitable for the load as stipulated by the appliance data label.

The electrical installation and connections should meet the necessary requirements of the local electrical wiring regulations and any electrical safety guidelines.

### We Recommend:

- Supplementary electrical protection with the use of a residual current device (RCD)
- Fixed wiring appliances incorporate a locally situated switch disconnector to connect to, which is easily accessible for switching off and safe isolation purposes. The switch disconnector must meet the specification requirements of IEC 60947.



The supply to this machine must be protected by a **30mA RCD**

# Contents:

1. Introduction
2. Dimensions
  - 2.1. Two-Pocket Roll Plant
  - 2.2. With Roll Forming Unit
3. Specifications
4. Safety Guide
  - 4.1. General Safety Precautions
5. Installation
  - 5.1. The Two-Pocket Roll Plant
  - 5.2. Connecting the Roll Forming Unit (if purchased)
6. Isolation
7. Operating Instructions – Two-Pocket Roll Plant
  - 7.1. Start Up
  - 7.2. Engineering Settings
    - 7.2.1. HMI Configuration
      - 7.2.1.1 *Offline*
      - 7.2.1.2 *System (Date & Time, Brightness etc.)*
      - 7.2.1.3 *Diagnostics*
    - 7.2.2. Service Menu
  - 7.3. Information Screen
  - 7.4. Alarms Log
  - 7.5. Automatic Mode
  - 7.6. Manual Mode
    - 7.6.1. To Save a Product Recipe
    - 7.6.2. To Edit or Copy a Product Recipe
  - 7.7. Recipe Mode
    - 7.7.1. To Backup All Product Recipes
    - 7.7.2. To Restore All Product Recipes
    - 7.7.3. To Delete Product Recipes
8. Operating Instructions - Roll Forming Unit (if fitted)
9. Two-Pocket Roll Plant Cleaning and Maintenance
  - 9.1. General Advice
  - 9.2. Flour Dusters
  - 9.3. Dough Hopper
  - 9.4. Pre-Scaler
  - 9.5. Filling Chamber and Filling Piston
  - 9.6. Drum and Rounder
  - 9.7. Pressure Roller and Cleaning Brushes
  - 9.8. Oil Reservoir
  - 9.9. The Flour Dust Catcher
10. Roll Forming Unit Cleaning and Maintenance (if fitted)
  - 10.1. General Advice

- 10.2. The Cleaning Position
- 10.3. Belts, Brushes, Rollers & Guides
- 10.4. Belt Tensioning Adjustment
- 10.5. Lubricating the Bearings, the Adjustment Levers & the Support Cross Bar
- 11. Recommended Cleaning Schedule
- 12. Manual Operation – Power OFF
- 13. Hints & Tips
- 14. Electrical information – Two Pocket Roll Plant
- 15. Alarm Messages
- 16. Environmental Disposal
- 17. Service and Spares – Contact Details

# 1. Introduction: ---

MONO's Two-Pocket Roll Plant is designed to effortlessly and reliably produce high volumes of bread rolls with accuracy and consistency and has an output of up to 3,200 rolls per hour. Requiring just one person to operate, the compact Two-Pocket Roll Plant fully automates the dividing and rounding process, producing a wide range of rolls with a weight range of between 30-100g. The highly intuitive colour Touch Screen Controller controls every element of the roll production process and stores up to 60 programs for future use.

With the addition of MONO's optional Roll Forming Unit, the Two-Pocket Roll Plant's repertoire can be extended to include finger rolls, petit pain and burger buns.

## **Key Features:**

- Fully automated process
- Produces up to 3,200 rolls per hour
- Weight range between 30-100g
- Exceptional accuracy of weight, size and shape
- Small footprint fits most bakeries
- User-friendly, colour Touch Screen Controller
- Stores up to 60 programs
- Integrated Flour Duster
- One person operation
- Locking Safety Castors
- Optional Roll Forming Unit to extend the product range

# 2. Dimensions: ---

## 2.1. Two-Pocket Roll Plant:

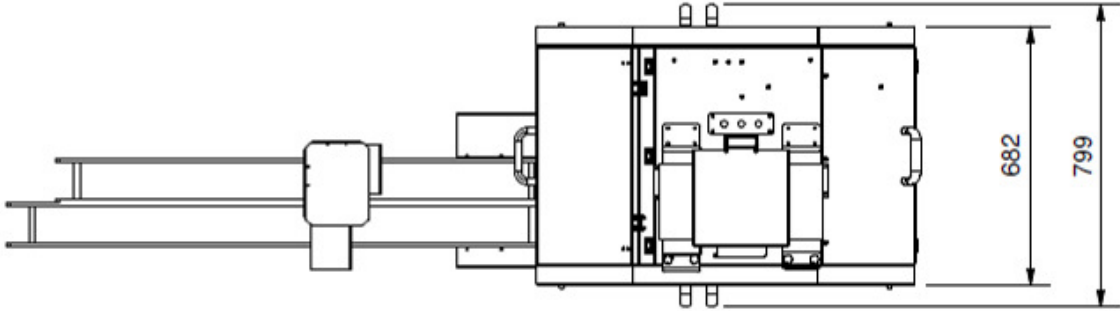
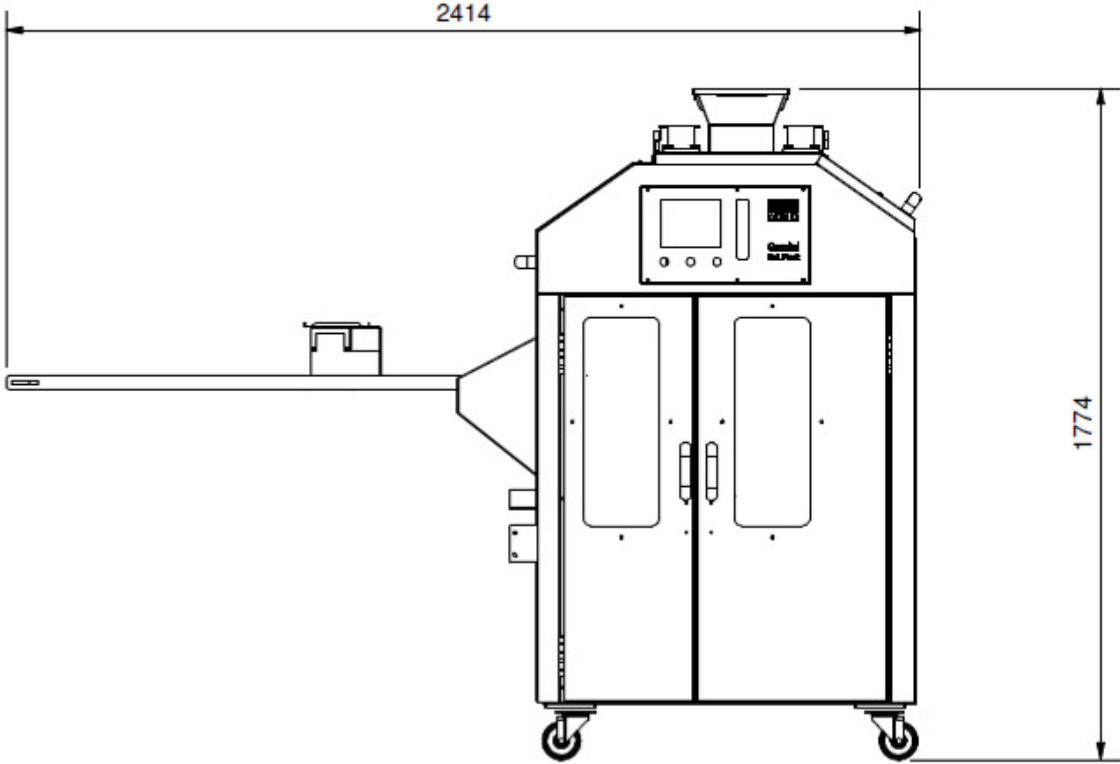

## 2.2. With Roll Forming Unit:

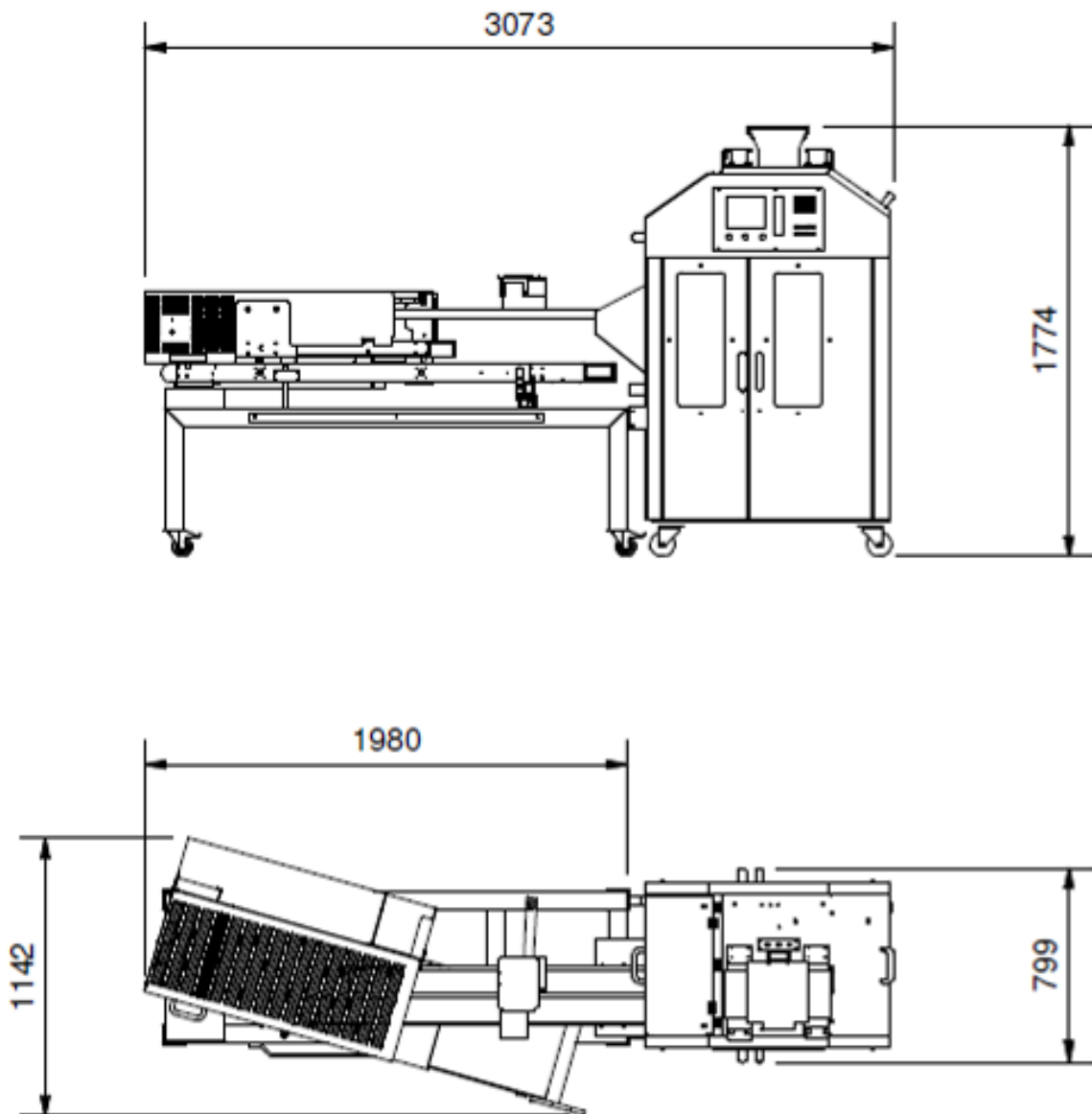



### 3. Specifications:

Two-Pocket Roll Plant	Specification
Length	2414mm
Width	799mm
Height	1,774mm
Weight	590Kg
Roll Weight Range	30-100g
Output Capacity	Up to 3,200 rolls per hour
Piston Diameter	64mm
Supply Voltage	415V, 3Phase +N +E, 50-60Hz, 1.8kW
Fuse Rating	16Amp
Noise Level	Less than 85dB
Two-Pocket Roll Plant with Roll Forming Unit	Specification
Length	3,073mm
Width – Unit Open	1,142mm
Width – Unit Closed	650m
Height	1,774mm
Weight	280Kg
Supply Voltage	2.55kW





The supply to this machine must be protected by a **30mA RCD**

# 4. Safety Guide:

---

## 4.1. General Safety Precautions:

- Ensure this Manual is read thoroughly before operating the machine
- The equipment must be installed by qualified personnel only
- Ensure the mains power supply matches the power requirements of the machine
- All machine operators should be fully trained before operating the machine
-  — Always ensure hands are dry before touching any electrical components including cables, switches and plugs
- Ensure the machine is switched OFF at the mains isolator when not in use
- Never use the machine in a faulty condition and always report any damage immediately
- No one under the age of 16 should be permitted to operate this machine
- No loose clothing, ties or jewellery should be worn when operating the machine
- Only trained personnel should be permitted to remove any part of the machine that requires the use of tools
- Never operate the machine with any panels removed
- Safety guards should not be removed under any circumstances
- A responsible manager should carry out daily Safety Checks on the machine
- Do not strike the Touch Screen Controller with a hard or pointed object, or press the panel with excessive force
-  — Hand contact with moving surfaces may cause friction burns to skin
- **Ensure the machine is switched off at the mains isolator before any cleaning or maintenance work takes place**
-  — **Do NOT attempt to clean the moulding areas when the machine is running**
- **Do NOT insert hands or any other item into the Flour Duster when the machine is running**
- **As flour dust can be highly combustible please ensure only an ATEX approved Safety Vacuum Cleaner is used for cleaning purposes**

# 5. Installation:

## 5.1. The Two-Pocket Roll Plant

- The machine is fitted with 2 fixed and 2 lockable swivel castors for ease of positioning and safety
- The machine can be picked up using a forklift or pallet truck under the main frame between the wheels
- Ensure the machine is standing level on a solid floor
- When installing the machine, the operator should make the following areas accessible:
  - Control panel
  - Side panels
  - Back panel
- This will aid cleaning during use, without the need to move the machine
- The electrical connection is made using a 16 Amps plug



The supply to this machine must be protected by a **30mA RCD**

- The terminal value of the machine is 10 Amps at 415V 3 phases
- An electrical wiring diagram can be found inside the fuse box
- Turn the main isolator switch to “I” position, to power ON

## 5.2. Connecting the Roll Forming Unit (if purchased)

- To connect the Two-Pocket Roll Plant and the Roll Forming Unit simply position the two pieces of machinery together, ensuring the locating plates on both machines are aligned
- Using the black Thumb Screws provided, secure two in each fixing plate on both sides of the machine and turn until finger-tight
- Once secured, connect the power supply lead from the Roll Forming Unit to the Two-Pocket Roll Plant and secure in place using the integrated top and bottom clips



*Use the Two Black Thumb Screws to Secure the Connecting Plates on Both Sides of the Machines*

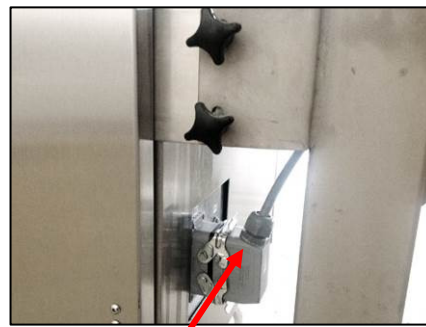

*Connect the Roll Forming Unit Power Supply to the Socket on the Two-Pocket Roll Plant and Clip in Place*

# 6. Isolation: \_\_\_\_\_

In an emergency, switch the plant OFF at the main power supply, the main isolator on the end panel or push the emergency stop button below the main Control Panel.

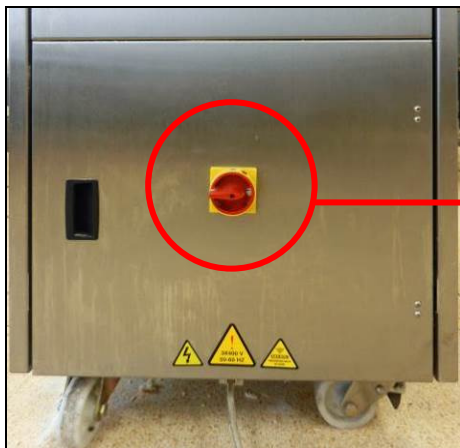

Main Isolator Switch

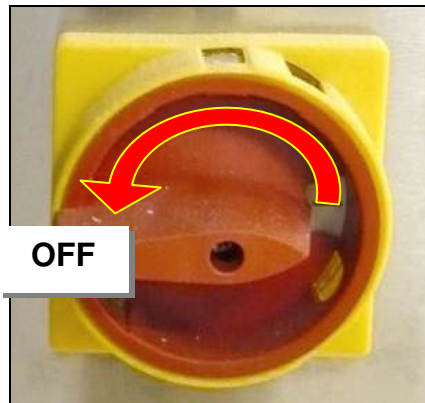

Touch Control Panel



Twist to Release

# 7. Operating Instructions –

## Two-Pocket Roll Plant:

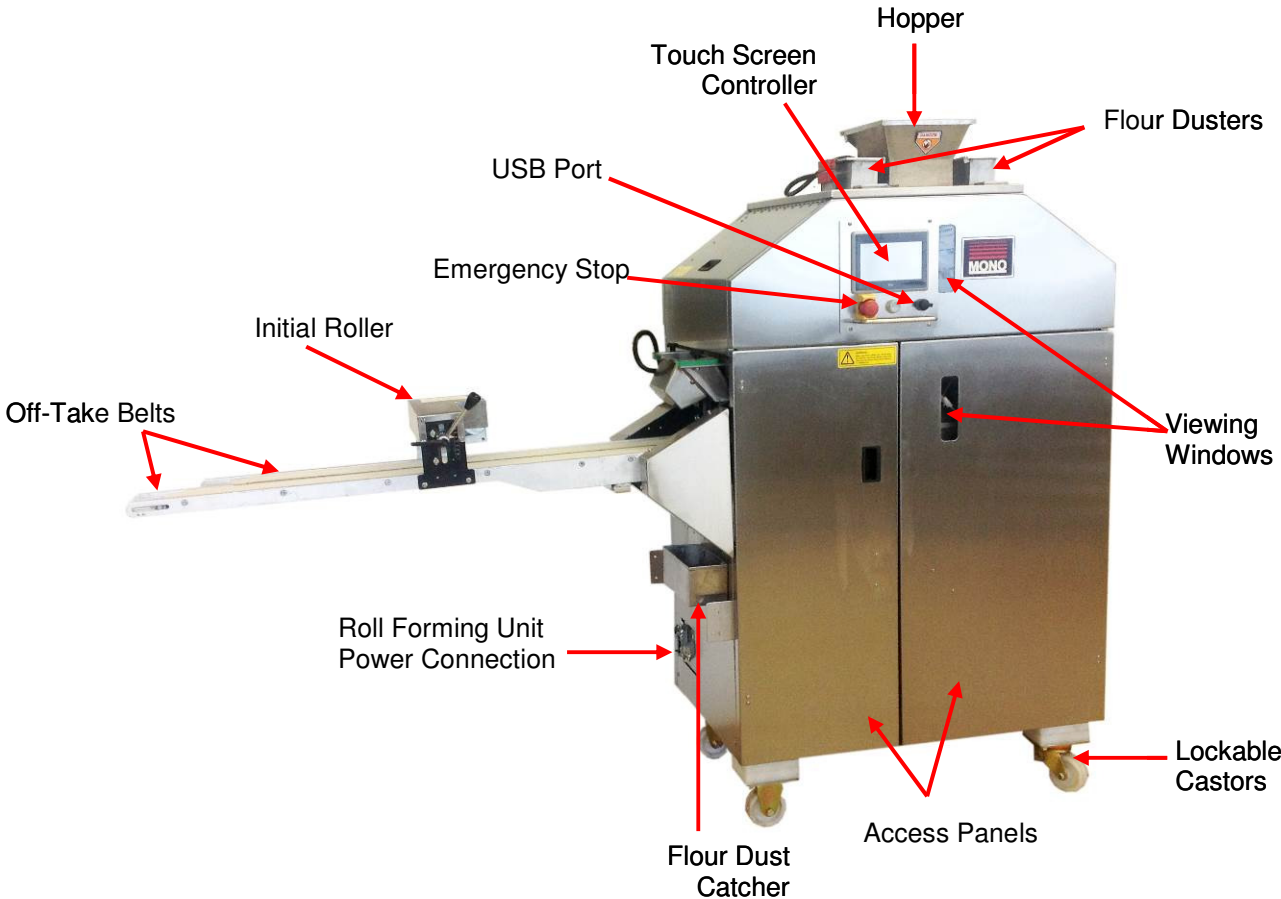

## 7.1. Start-Up:

- When the machine is first switched on the following 'Home Screen' will appear
- Select the green 'Start' button to continue. This will run through the settings and re-calibrate the machine ready for use
- This will then load the main 'Main Program Screen'

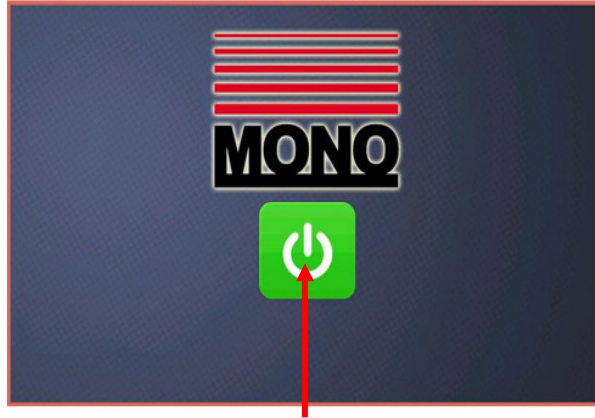

*Home Screen Showing 'Start' Button*

- There are 3 large Icon options on the 'Main Program Screen':
  - **Automatic** (green) – to load previously stored programs
  - **Manual** (blue) – to run one-off programs, to create new programs and store for future use
  - **Recipes** (orange) – to manage programs, edit, delete, upload and download using a USB stick
- At the bottom of the screen are 4 further icons (from left to right):
  - **Settings** (blue) – general settings screen
  - **Information** (green) – power used, life timer, unit price, consumption, pieces produced etc
  - **Alarms** (yellow) – active alarms / historic alarms / alarm log
  - **Standby** (red) – returns to the 'Home Page'



*Main Program Screen*

## 7.2. Engineering Settings:



*Settings*

- Selecting on the 'Settings' button provides access to the main default settings for the machine
- To access, click the blue service button and enter 1972
  
- The 'Settings' menu has 2 main options:
  - **HMI Configuration** – offline settings, system settings , diagnostics
  - **Service Menu** – Belt , pinner & duster settings, IO test, IO diagnostics

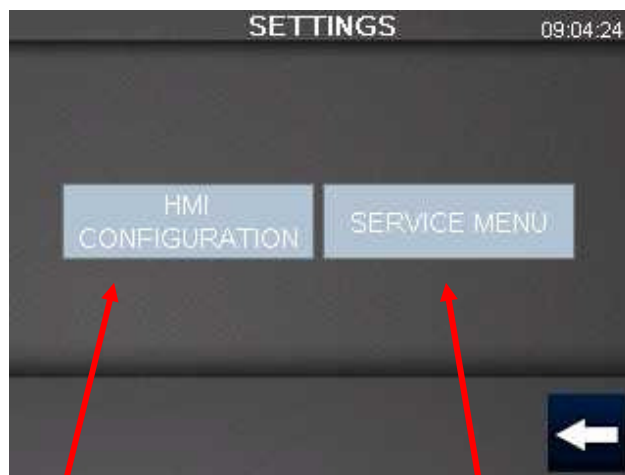

*HMI Configuration*

*Service Menu*

## 7.2.1 HMI Configuration:

The HMI configuration page has 3 main option tabs:

- **Offline**
- **System**
- **Diagnostics**

### 7.2.1.1 Offline:

The Offline tab enables access to settings regarding the HMI only

### 7.2.1.2 System:

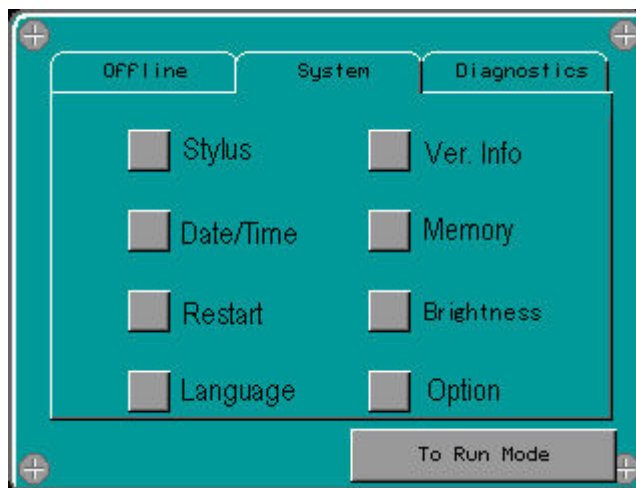

The system tab enables access to:

- **Stylus** – Used for screen calibration
- **Date / Time** – For setting the Date & Time
- **Restart** - To restart the operating system
- **Language** – N/A
- **Ver. Info** – Display system runtime versions
- **Memory** – Memory statistics
- **Brightness** – Screen brightness adjustment
- **Option** – N/A

### 7.2.1.3 Diagnostics:

The Diagnostics tab enables access to:

- **Variables** – N/A
- **Statistics** – Displays communication statistics



## 7.2.2 Service Menu

- Select the 'Service' button to be taken to the main 'Service' screen

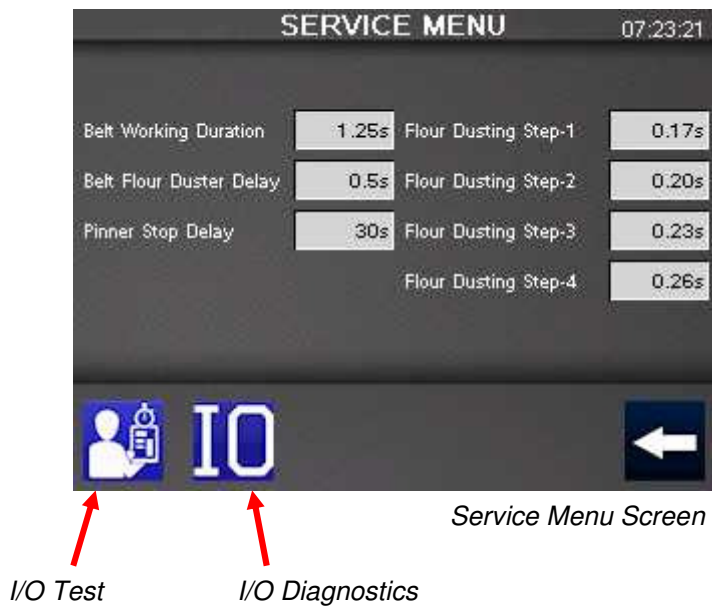

- The 'Service Menu' page displays the working durations in seconds of the main belt and flour dusters and the delay duration in seconds of the belt flour duster and pinner stop delay.
- At the bottom of the 'Service' screen the 'I/O Test' button provides access to the following screen

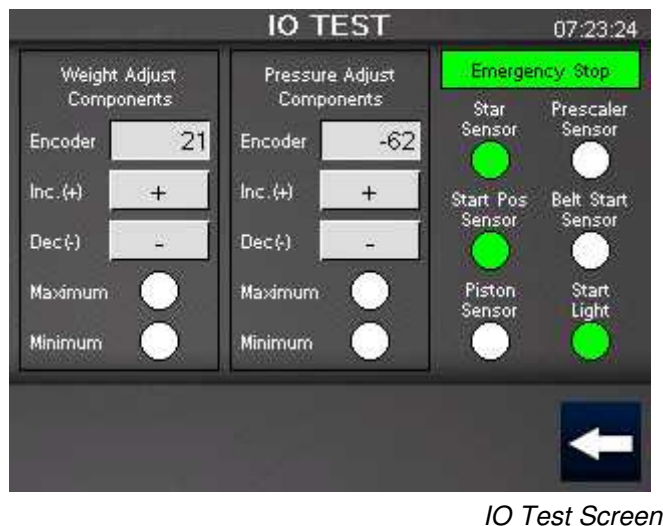

- The black 'Arrow' button takes you back to the previous screen

- At the bottom of the 'Service' screen the 'I/O Diagnostics' button provides access to the following 4 information screens



IO Diagnostics screen 1



IO Diagnostics screen 2



IO Diagnostics screen 3



IO Diagnostics screen 4

### 7.3 Information Screen:

- The 'Information' screen provides basic information on power consumption and products produced:
  - **Life Timer** – the total number of hours the Two-Pocket Roll Plant has been running
  - **Unit Price** – the unit price of electricity being used
  - **Consumption** – the total value of electricity used
  - **Pcs** – the total number of rolls produced since the last 'Reset' took place

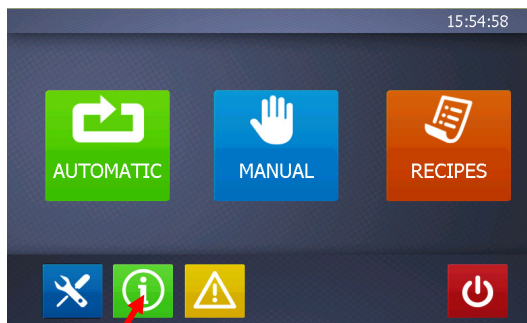

*Information*



*Enter Required Values*

- Select the green 'Information' button and input the relevant values for each field stated above
- To reset the production quantity at any time select the 'Reset' button the left of the 'Pcs' field
- Select the 'Arrow' back button to return to the previous menu

# 7.4. Alarms Log

— Select the yellow 'Alarm' button to enter the Alarms screen

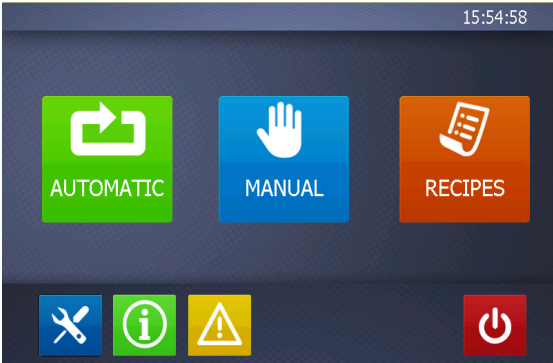

Yellow Alarm Button

- The pop up window will give access to active alarms , historic alarms and alarms log
- To scroll through the pages press the buttons across the bottom of the screen



Alarm Log  
Historic Alarms  
Active Alarms

## 7.5. Automatic Mode

- When the Automatic Mode is selected the following Product Category screen appears:



*Product Category Screen*

- The Product Category Screen has 3 main Roll Type options (from left to right):
  - **Burger Buns** – flattened buns suitable for burgers etc
  - **Finger Rolls** – elongated rolls
  - **Round Rolls** – standard round rolls
- Select the Product Category Type of roll you wish to produce
- This takes you to the 'Product Recipe List' of programs you have previously stored



*Product Recipe List*

*Load Button*

- Select the 'Product Recipe' you wish to load from the list and press the load button on the bottom left of the screen
- If there aren't any programs in the list, you will first need to create them in 'Manual' mode and store them for future use. Please see 'Manual' mode for full details
- Once the correct recipe has been selected press the 'LOAD' button

- The chosen Product Recipe Program will load into the screen below which you can start



*Product Recipe Program Screen*

- The 6 columns shown on the screen relate to different elements of the Product Recipe program (from left to right):
  - **Speed** – the speed that the machine is running at
    - Input value 1 to 10, 1 being the slowest
  - **Dough Cavity Depth** – the depth of the dough rounding cup
    - Input value 20 to 46
  - **Pre-Scaler Flour Duster** – the amount of flour deposited at the pre-scaler stage
    - Input value 0 to 3, 0 is Off
  - **Weight** – the weight of the dough piece
    - Input value 30g to 105g
  - **Conveyor Belt Flour Duster** – the amount of flour deposited on the off-take belts
    - Input value 0 to 4
  - **Rounder Tray Speed** – the speed of the Rounder Tray during the rounding process
    - Input value 10 to 75
- Any of the above settings can also be changed at any time during run-time, but will only remain active whilst running and will not overwrite the previously saved 'Product Recipe' program
- At the bottom of the screen are 4 more buttons (from left to right):

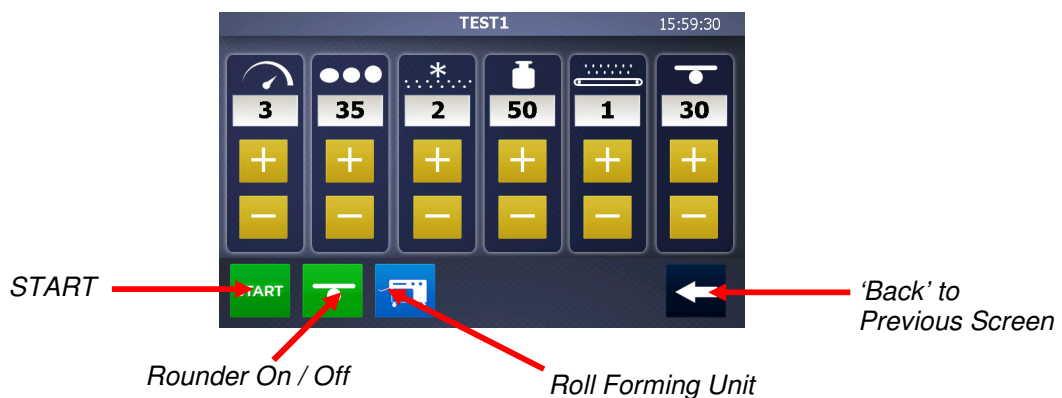

- **START** – start the Product Recipe Program. When pressed this will change to a red **STOP** button which can be used to stop the program
- **Rounder** – to switch the Rounding device ON and OFF
- **Roll Forming Unit** – to enter the Roll Forming Unit setup screen (optional extra)
- **Arrow** – found on the bottom right of the screen – returns to the previous screen

## 7.6. Manual Mode

- Manual Mode is used to run one-off programs and also to design Product Recipe Programs to be saved in Recipes for future use
- When the Manual Mode is selected the following Product Recipe Program screen appears:

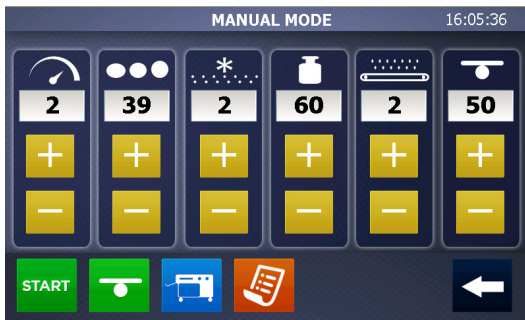

*Product Recipe Program Screen*

- The 6 columns shown on the screen relate to different elements of the Product Recipe program (from left to right):
  - **Speed** – the speed at which the machine is running
  - **Dough Cavity Depth** – the depth of the dough rounding pocket
  - **Pre-Scaler Flour Duster** – the amount of flour deposited at the pre-scaler stage
  - **Weight** – the weight of the dough piece
  - **Conveyor Belt Flour Duster** – the amount of flour deposited on the off-take belts
  - **Rounder Tray Speed** – the speed of the Rounder Tray during the rounding process
- At the bottom of the screen are 5 more buttons (from left to right):
  - **START** – start the Product Recipe Program. When pressed this will change to a red **STOP** button which can be used to stop the program
  - **Rounder** – to switch the Rounding device ON and OFF
  - **Roll Forming Unit** – to enter the Roll Forming Unit setup screen (optional extra)
  - **Recipe** – to save Product Recipe programs
  - **Arrow** – found on the bottom right of the screen – returns to the previous screen

## 7.6.1. To Save a Product Recipe

- Once you are happy with the 'Product Recipe' you can save it for future use by selecting the orange Recipe button



*Product Recipe Program Screen*

- This will send you to the Recipe Handling Screen



*Recipe Handling Screen*

- Select the 'Product Category' under which you wish to store your 'Product Recipe' (from left to right):
  - **Burger Buns** – flattened buns suitable for burgers etc
  - **Finger Rolls** – elongated rolls
  - **Round Rolls** – standard round rolls



- Scroll to the next available space and select the 'Save' button
- Enter the name of the product you wish to save for future use
- Press the 'Arrow' button to return to Main Menu



*Save Recipe Screen*

## 7.6.2. To Edit or Copy a Product Recipe

- Load the Product Recipe you wish to Edit up by following the instructions detailed in Automatic mode featured at 7.5 above
- Once the Product Recipe has loaded and you have the detailed information screen shown below click the back 'Arrow' button



*'Back' to Previous Screen*

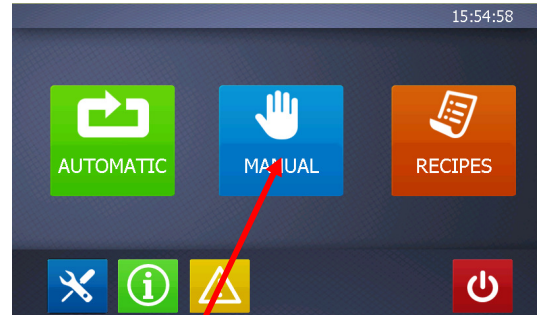

*Select the 'Manual' Button*

- Select the 'Manual' button and make the necessary changes to the Product Recipe by altering the settings as appropriate



*Recipe button*

- Once satisfied with the new settings select the 'Recipe' button
- Select the relevant Product Category group under which the programme is to be saved
- There are now two options available – either update the existing programme with the new Product Recipe values or create a new Product Recipe by saving it under a different name
- To update an existing Product Recipe, select the name of the product in the list so that it is highlighted in blue then click on the 'Save' button
- To create a new Product Recipe, type the name of the new product in the Recipe Name box and then select the 'Save' button

## 7.7. Recipe Mode

- Recipe Mode provides the facility to:
  - **Delete** existing Product Recipe programs from the system
  - **Backup** Product Recipe programs to a USB for backup security
  - **Restore** previously saved programs from USB to the system

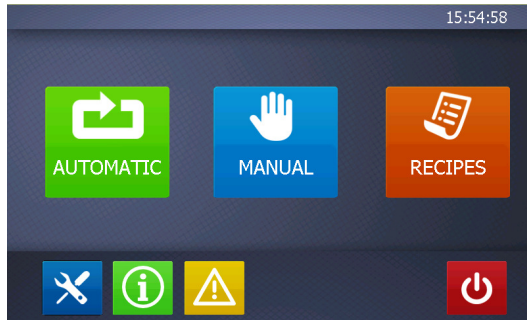

*Main Product Screen*



*Backup and Restore Screen*

- Select the orange Recipes button
- This takes you to the Backup and Restore screen
- There are four options available:
  - **Backup All** – backs up all Product Recipes onto a USB stick
  - **Restore All** – restores all previously saved Product Recipes from a USB stick to the machine
  - **Selective Backup** – backs up a whole Product Type category ie. Burger Buns, Finger Rolls, Round Rolls
  - **Selective Restore** – restores an entire Product Type category ie. Burger Buns, Finger Rolls, Round Rolls

## 7.7.1 To Backup All Product Recipes

- Flip the black plastic cap of the USB port situated below the bottom right hand corner of the screen
- Insert a standard USB stick

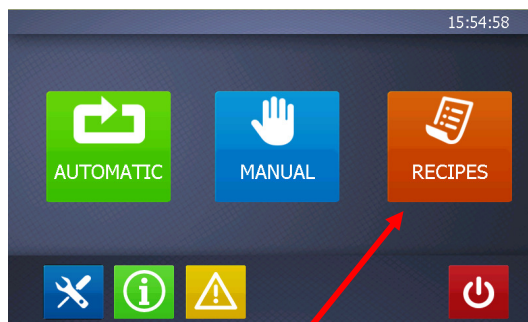

*'Recipe' Button*



*'Backup All' Button*

- Press the 'Recipe' button
- Select the 'Backup All' button
- The top right hand corner of the screen will indicate that the database is being exported in .csv format. When this message disappears the USB stick can be removed
- Replace the black plastic cap on USB port

## 7.7.2. To Restore All Product Recipes

- Flip the black plastic cap of the USB port situated below the bottom right hand corner of the screen
- Insert a standard USB stick



*'Restore All' Button*

- Press the 'Recipe' button
- Select the 'Restore All' button
- The top right hand corner of the screen will indicate that the database is being imported in .csv format. When this message disappears the USB stick can be removed
- Please note that a Restore All will replace all existing Product Recipes in the machine with the information stored on the USB stick
- Replace the black plastic cap on USB port

### 7.7.3 To Delete Product Recipes

- Select the 'Recipe' button
- Select the Relevant Product Category type



- Enter password '3142'
- Select the 'Product Recipe' that needs to be deleted



*'Delete' Button*

- Select the 'Delete' button
- Confirm whether you wish to permanently delete the 'Product Recipe' Yes/ No

## 8. Operating Instructions – --- Roll Forming Unit (if fitted)

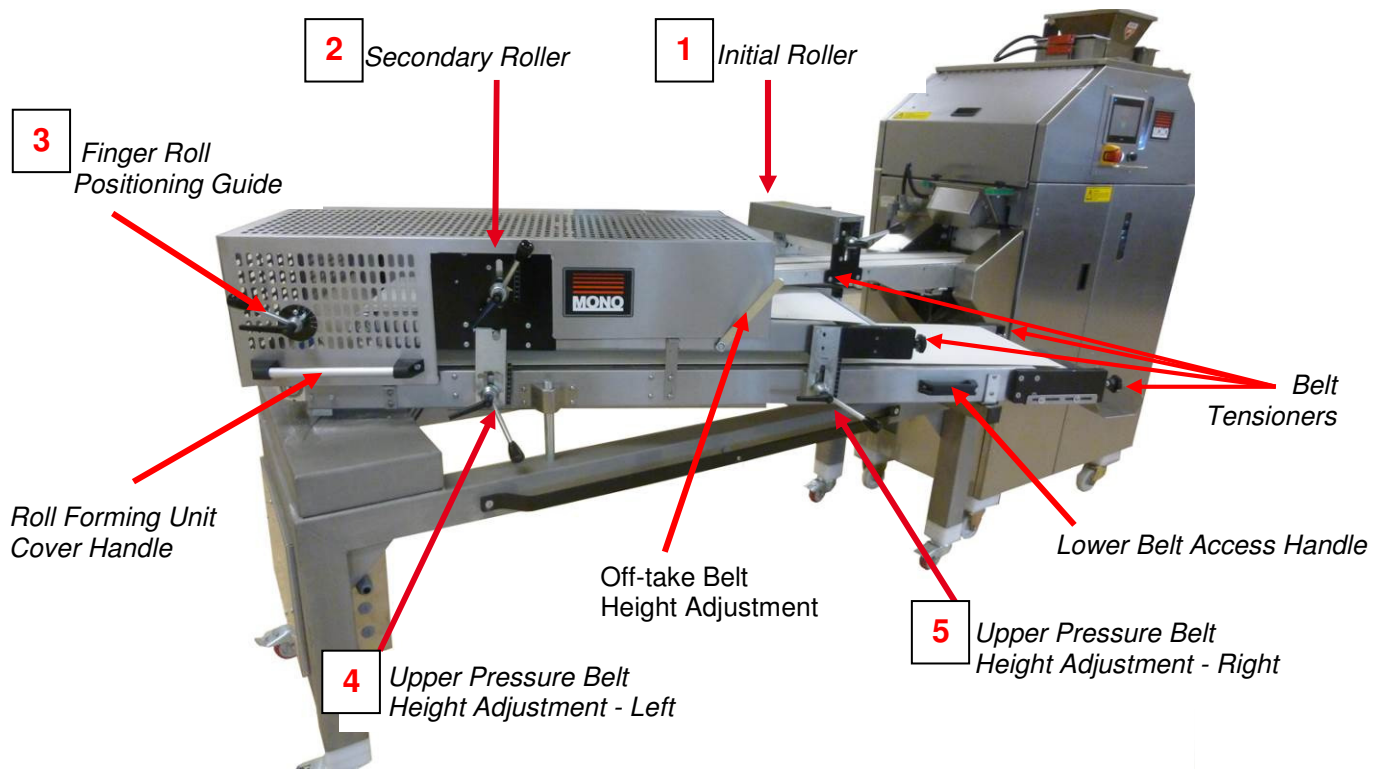

- The Roll Forming Unit is available as an optional extra to the Two-Pocket Roll Plant and provides the additional facility to produce a wider range of roll including Burger Buns and Finger Rolls
- The roll shapes can be created by adjusting a series of rollers and pressure belts which mould the round roll output from the Two-Pocket Roll Plant into either a flattened burger roll or an elongated finger roll
- There are 5 key devices on the Roll Forming Unit to achieve the desired results:
  - 1. Initial Roller** – provides first flattening (burger buns)
  - 2. Secondary Roller** – provides further reduction (burger buns)
  - 3. Finger Roller Positioning Guide** – positions dough piece on bottom belt
  - 4. Upper Pressure Belt Left Side** – height adjustment for final product
  - 5. Upper Pressure Belt – Right Side** – height adjustment for final product
- Also located at the front of each Belt are two Belt Tensioners which can be used to adjust the tension of the top and bottom belts should the need arise
- Once the desired roll size, shape and dimensions have been achieved the values from each of the Rollers and Belts needs to be transferred into the Product Recipe program for future use

- To store the values from the Roll Forming Unit to the Product Recipe programme for future reference, select the blue 'Roll Forming Unit' button at the bottom of the screen

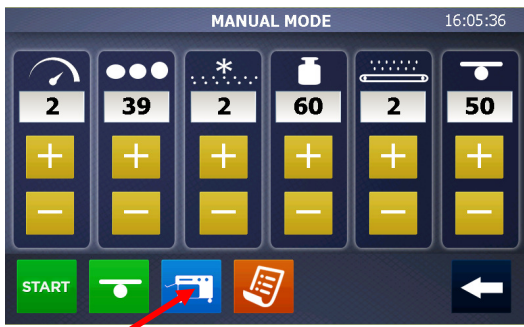

Blue Roll Forming Unit Button

- Following the numbers featured on the Rollers, Guide and Pressure Belts, enter the value of each Lever to the corresponding number on the Roll Forming Values screen

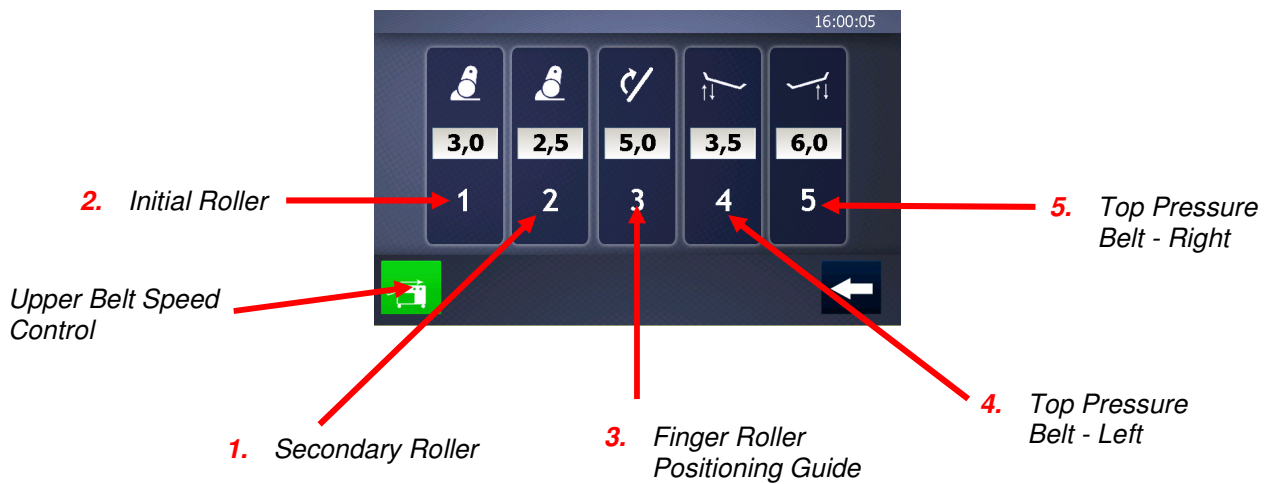

- The green button at the bottom left hand corner of the screen toggles the Upper Belt speed between standard single speed or double speed (x2)



Green = Upper Belt Single Speed



Blue = Upper Belt Double Speed

- Once all values have been entered, select the 'Arrow' button to return to the previous screen

# 9. Two-Pocket Roll Plant - Cleaning & Maintenance

---

**Note: Switch Off and Isolate the Machine from the Mains Power Supply**

**Before Commencing any Cleaning or Maintenance Work**

## 9.1 General Advice:



- Always ensure the machine is disconnected from the main power supply before cleaning
- To obtain optimum performance and results it is essential to follow the recommended Cleaning Schedule
- For speed and efficiency ALWAYS clean the Two-Pocket Roll Plant from the top down
- All surfaces coming into contact with dough should be cleaned daily
- Remove all scraps of dough from the filling chamber and clean with food-based oil from a spray can
- Do not use jets of water to clean the machine or control panel
- Do not use solvents which could damage the paint and synthetic materials
- Only plastic scrapers and brushes should be used – do not use steel scrapers
- Compressed air should not be used to clean the machine, however, the use of an appropriate ATEX approved Safety Vacuum cleaner is recommended. Please see Safety Guidelines for details
- All external surfaces should be wiped down with a damp cloth and cleaner

## 9.2 The Flour Dusters:

- The two Flour Dusters situated either side of the Hopper can be cleaned using a stiff brush
- Both Flour Dusters can be removed from the machine for a more thorough cleaning by sliding the Retaining Plates to the unlocked position and easing the Flour Duster out front side first
- It is also advisable to vacuum clean the Flour Dusters to prevent infestation using an ATEX approved Safety Vacuum Cleaner
- When replacing the Flour Dusters insert the cog-end of the unit first then lower the remainder of the Flour Duster into position, then slide the Retaining Plates back into the locked position



*Slide the Retaining Plate to the Unlocked Position on Each Sides of the Flour Duster*



*Lift the Front of the Flour Duster Upwards to Remove and Insert the Cog-End First in Order to Replace*



### 9.3 The Dough Hopper:

- This should be done after every production run or at the end of each day
- Do NOT leave dough in the hopper as this will be difficult to clean later and may cause a malfunction
- Lift the top access panel
- The integrated gas struts will support the panel in position and prevent it from falling closed
- Clean the hopper and surrounding area thoroughly
- To close, pull the handle down and gently lower the assembly into place, then close the outer access door



*Lift the Outer Access Door Upwards*

### 9.4 The Pre-Scaler:

- Open the Cleaning Plate by unscrewing the cross handled screw
- Once unscrewed, remove the Plate and clean the Pre-Scaler area of any residue dough or flour
- Once clean securely screw the Cleaning Plate back in position

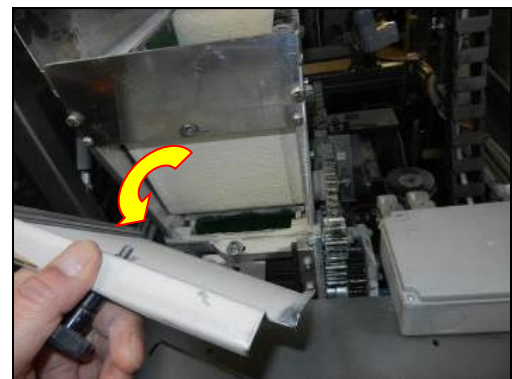
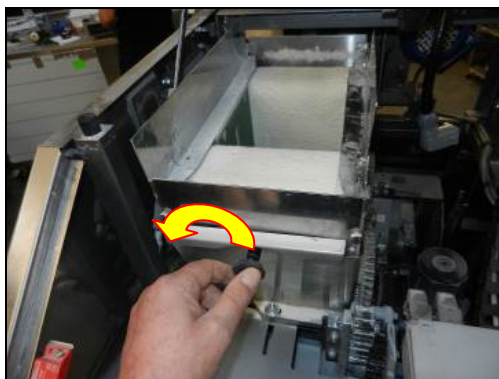

## 9.5 The Filling Chamber and Filling Piston:

- Loosen the Retaining Knob positioned on the top left hand side of the Piston Plate sufficiently to allow the Plate to be removed
- Grab the handle on the Piston Plate and pull towards you to remove

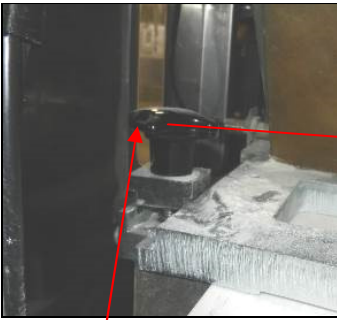

Loosen Retaining Knob

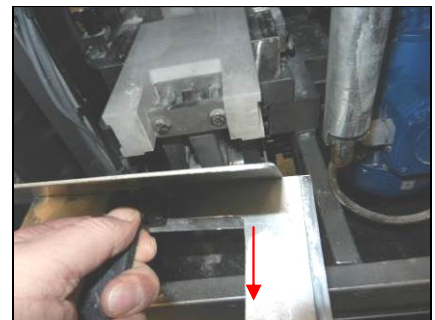
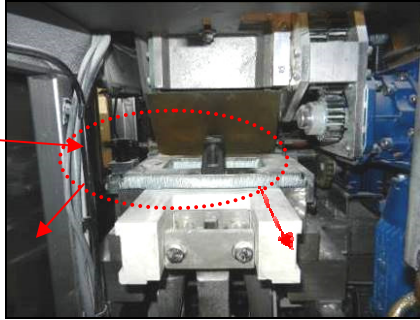

Remove Piston Plate to Access

- Lift Piston upwards over the roller and remove completely

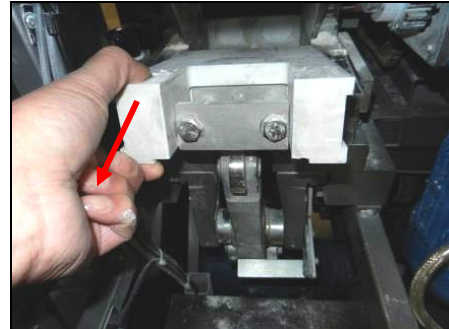
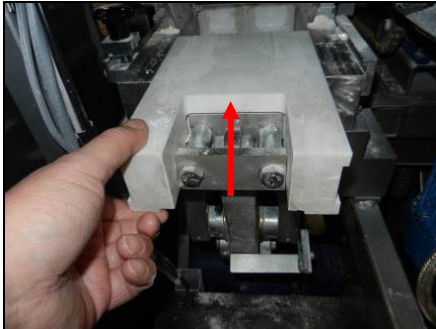

- Clean the Piston thoroughly and return to its position
- Clean the filling chamber
- Ensure that the two perspex side panels are clear of flour dust
- Replace the Piston Plate and hand tighten the retaining knob

## 9.6 The Drum and Rounder:

- Open the access door upwards
- Press the Release Button to release the Handle
- Rotate the Handle anti-clockwise until it stops to release the retaining pin
- Grabbing both handles firmly pull the Rounding Unit forwards. The Unit is quite heavy but is supported by gas struts which prevents it from falling back into place



*Press the Button to Release the Handle*

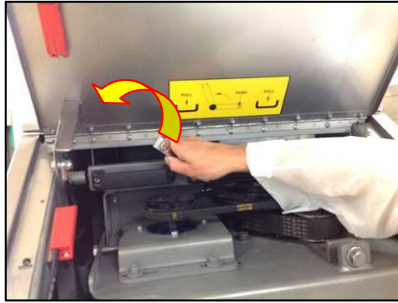

*Rotate the Handle Completely to the Left*



*Grab hold of Both Handles and Pull Forwards*

- Clean all accessible areas including the Base Plate, Side Guides, Rounding Plate and Chambers with a plastic scraper or brush
- Remove the Piston Plate to clean the pre-scaling area from this side of the machine

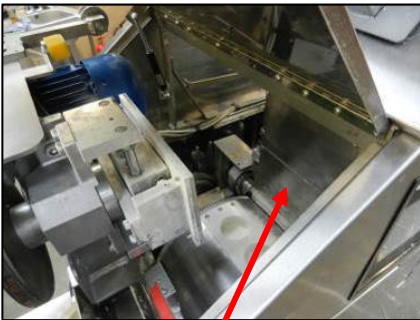

*Lift Piston Plate to Clean*

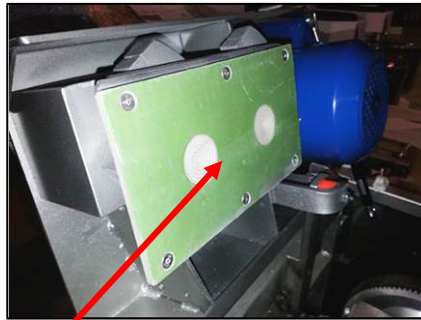

*Rounding Plate*



*Rounding Chambers*

- The metal pieces of the drum should be oiled weekly to ensure easy movement
- The Rounding Plate, especially the grooves can be cleaned with a stiff brush
- For maintenance, the Rounding Plate can also be removed by pivoting the plate and releasing the 6 countersunk screws. This will need to be done if the groves are no longer sharp.

## 9.7 The Pressure Roller and Cleaning Brushes

- The Pressure Roller and Cleaning Brushes are easily accessed via the left hand door
- To remove each component pull the Locking Pin downwards and slide the Roller or Brush from its position
- Clean both items thoroughly to remove any residual dough or flour with a scraper
- Flour the Pressure Roller before replacing
- When replacing, ensure the Locking Pins are located to secure the Roller and Brush in the correct position

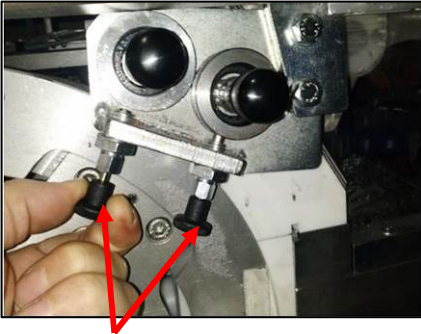

*Pull Downwards to Release The Locking Pins*



*Pull the Handle of the Pressure Roller to Remove*

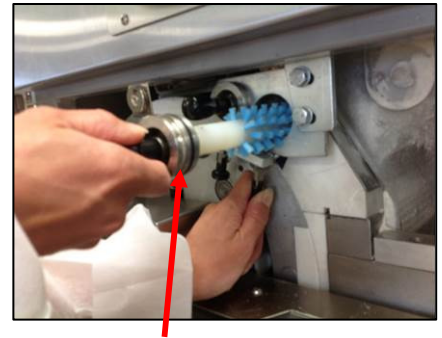

*Pull the Handle of the Brush to Remove*

- The lower Brush is removed by turning the Retaining Knob to the right and pulling the Roller Brush out smoothly
- Once removed, this gives access to the metal platform immediately below.
- Clean both the platform and Brush thoroughly and replace by inserting the Roller Brush onto the receiving rod and rotating until it engages with the retaining pin at the back. Turn anti-clockwise to lock in place

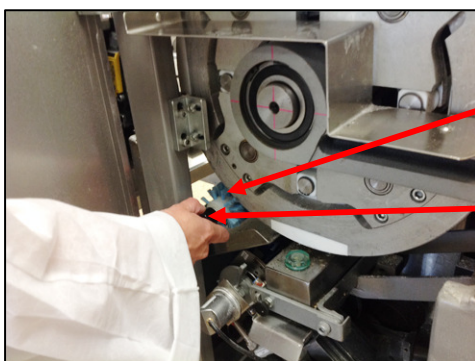

*Lower Brush*

*Retaining Knob*

## 9.8 Oil Reservoir:

- Turn the knob on the Retaining Bar located in front of the Oil Reservoir in a clockwise direction to release the Reservoir
- Grab both sides of the Oil Reservoir and pull it towards you to remove it
- Clean any residue oil from the surface and Oil Cap

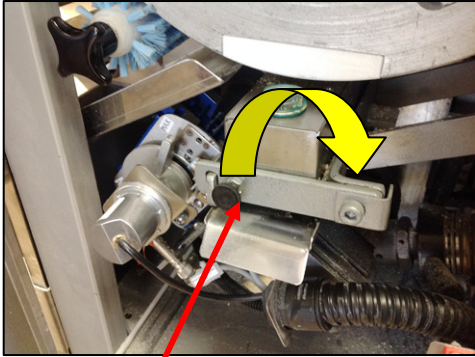

*Lift the Knob on the Oil Reservoir Retaining Bar Clockwise to Release*

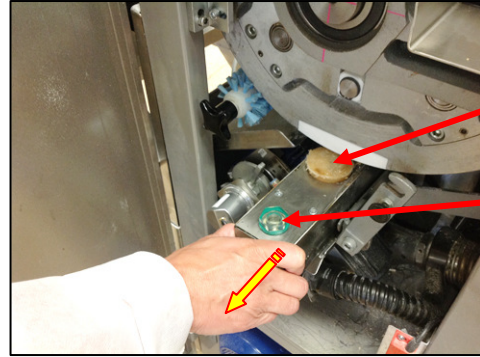

*Gently pull the Oil Reservoir Towards You to Remove*

- Dough residue on the oiling pads should be checked daily and removed as required.
- The oiling pads should be changed when worn; otherwise changing them every 2 to 3 years should be sufficient
- To replace them remove the top lid of the oil reservoir for easy access
- Please ensure the pressure springs are replaced after changing the pads
- The Oil Reservoir should be filled between  $\frac{1}{2}$  or  $\frac{3}{4}$  with food-safe divider oil.
- Once cleaned and replenished with oil, return the Oil Reservoir to its position and lock in place with the Retaining Bar by clicking it back in the locked position

## 9.9. The Flour Dust Catcher

- The Flour Duster Catcher is located below the main Off-Take Arms of the machine
- Simply lift the unit upwards off the locating pins using the keyhole locators
- Clean the Flour Dust Catcher thoroughly and replace



*Flour Dust Catcher Positioning*

### **Note:**

Once the above cleaning procedures have been actioned, open all access doors and ensure any residue dough pieces and flour dust are removed from around the inside of the machine. If vacuuming please ensure you use an ATEX approved Safety Vacuum Cleaner to avoid the potential for combustion.

Failure to adhere to the Cleaning and Maintenance instructions detailed in this document may affect the performance of the machine and ultimately the machine's warranty.

# 10. Roll Forming Unit - Cleaning and Maintenance (if fitted):

---



**Note:** Switch Off and Isolate the Two-Pocket Roll Plant from the Mains Power Supply Before any Cleaning or Maintenance Work is Carried out on the Roll Forming Unit

## 10.1 General Advice:

- Always ensure the Two-Pocket Roll Plant is disconnected from the mains power supply before cleaning the Roll Forming Unit
- To obtain optimum performance and results it is essential to follow the recommended Cleaning Schedule
- For speed and efficiency ALWAYS clean the Roll Forming Unit from the top down
- All surfaces coming into contact with dough should be cleaned daily
- Remove all scraps of dough from the rollers, brushes and belt systems
- Do not use jets of water to clean any part of the machine
- Do not use solvents which could damage the paint and synthetic materials
- Only plastic scrapers and brushes should be used – do not use steel scrapers
- Compressed air should not be used to clean the machine, however, the use of an appropriate ATEX approved Safety Vacuum cleaner is recommended. Please see Safety Guidelines for details
- All external surfaces should be wiped down with a damp cloth and cleaner

## 10.2. The Cleaning Position

- If the Roll Forming Unit's lower belt has not been pulled out, do so to gain access to the belts

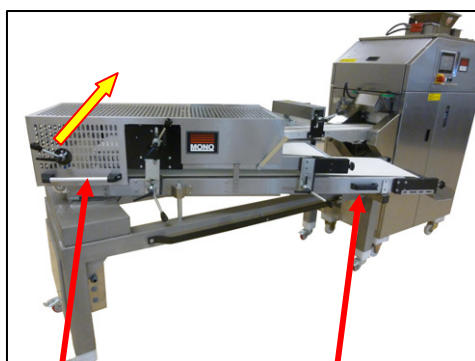

*Lower Belt Access Handle*

*Roll Forming Unit Cover Handle*

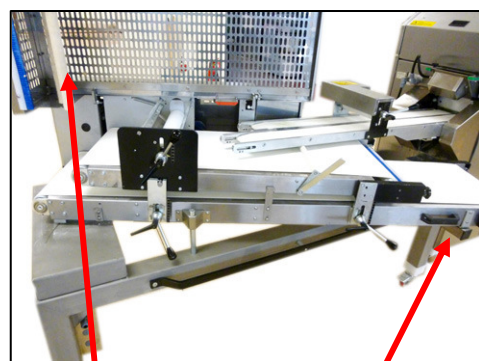

*Shows Lower Belt Pulled Out and Cover Open*

### 10.3. Belts, Brushes, Rollers & Guides

- Using the Roll Forming Unit Cover Handle, lift upwards to gain access to the Upper Belt, Brushes and Rollers etc
- Clean any flour or dough residue from the Two-Pocket Roll Plant's Off-take Arms and both Upper and Lower Belts

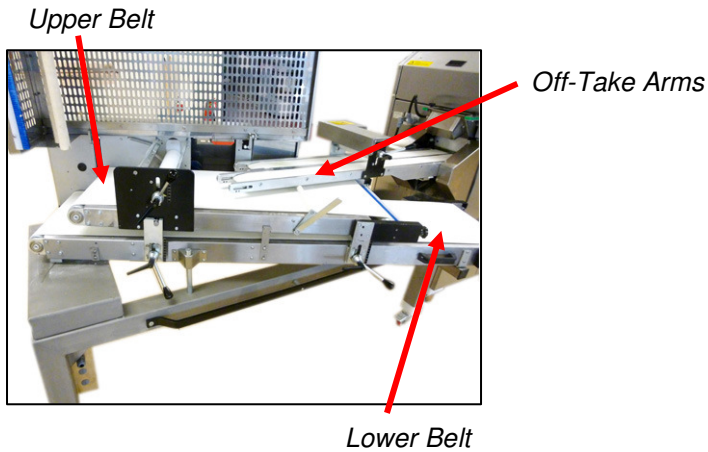

- Clean both sets of Blue Brushes found at the end of the Roll Forming Unit Cover and at the front of the Top Belt assembly, ensuring any flour or dough residue is removed
- Clean any dough remnants from the edge of the belts

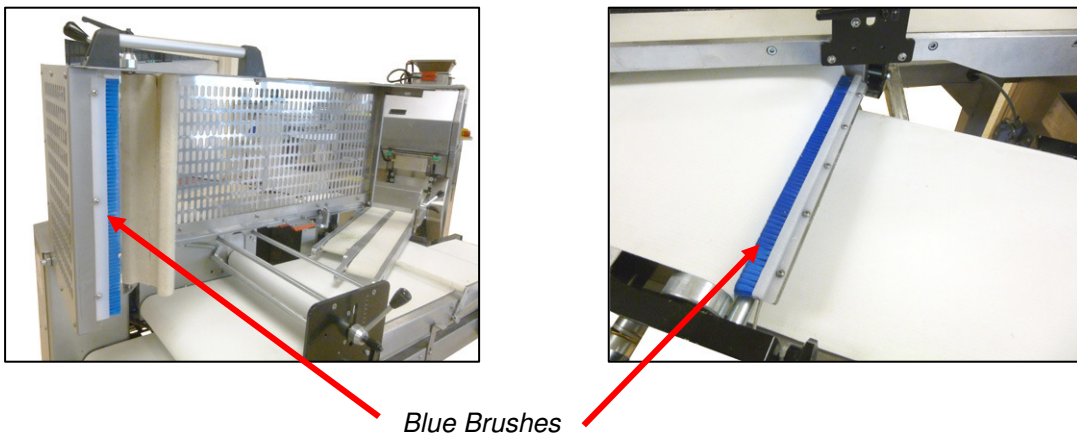

- Clean any dough and flour deposits from the edges of the belts and the collecting tray at the front of the Lower Belt
- Clean the Initial Roller and ensure it turns freely



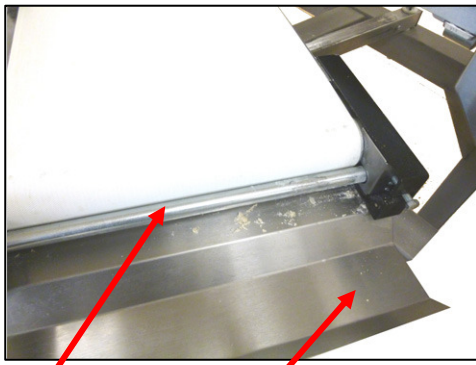

*Edge of Belt & Collecting Tray*

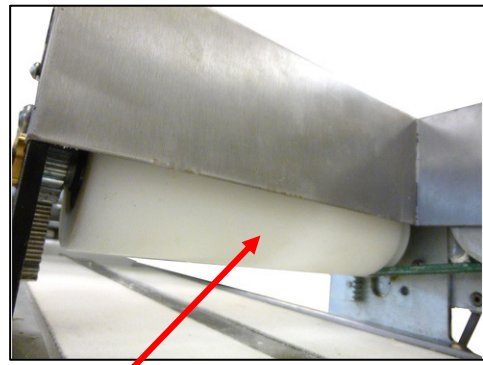

*Initial Roller*

- Clean the 'Roll Positioning Flap' and ensure no dough has stuck to the material
- Clean the 'Finger Roll Positioning Guide' so that the Upper Belt can run freely without obstruction

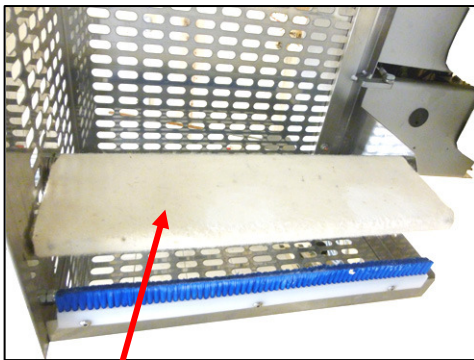

*Roll Positioning Flap & Brush*

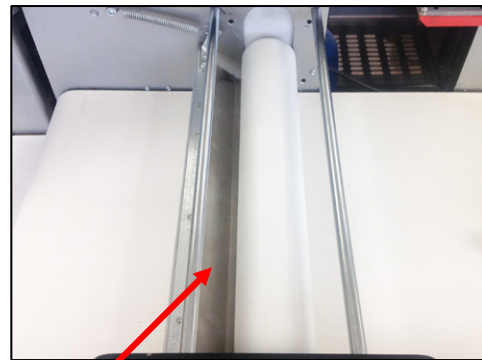

*Finger Roll Positioning Guide*

#### **10.4. Belt Tensioning Adjustment**

- Occasionally the Upper and Lower Belts of the Roll Forming Unit may need tensioning
- This should only be undertaken by a trained maintenance person
- Care should be taken when undertaking this process to ensure the belts are tensioned \_ on the right and left hand sides to ensure the correct alignment is retained

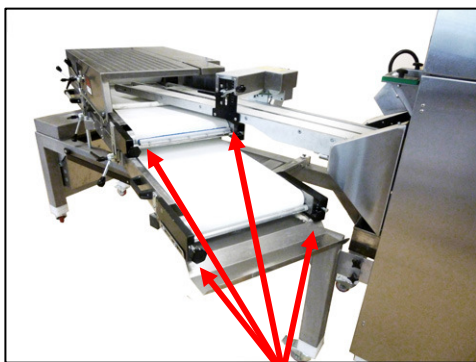

*Belt Adjustment Knobs*

- Failure to have equal tension right and left may result in the conveyor belts running unevenly and loose tracking

- The correct level of tensioning is achieved when a person's hand can just be inserted under the belt and the metal work frame

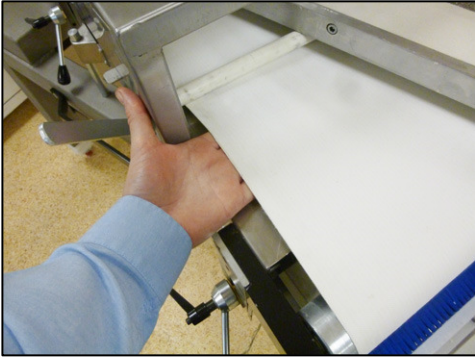

*Upper Belt Tensioning*



*Lower Belt Tensioning*

- Check the general condition of the belts to ensure there are no rips or tears. Report any damages so the belt can be replaced

### **10.5. Lubricating the Bearings, the Adjustment Levers & the Support Cross Bar**

- Any operational noise generated during normal running of the machine may be due to the bearings needing lubrication or replacement
- Oil the bearings to see if the noise stops. If the noise persists after lubrication, then the bearings may need replacing

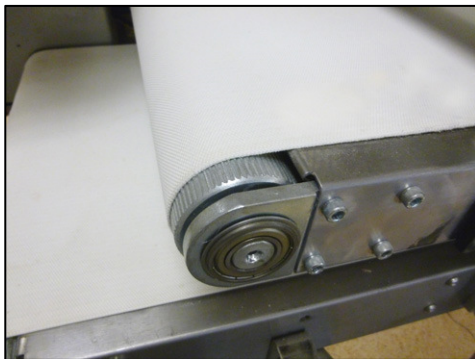

*Typical Bearings*

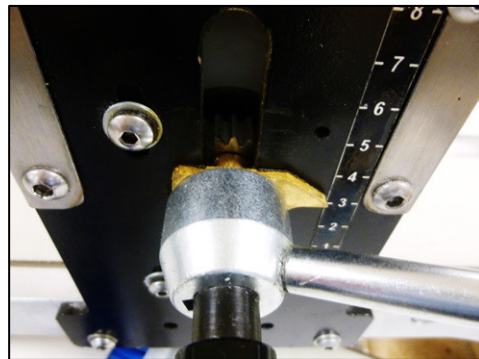

*Adjustment Levers*

- The adjustment levers should be free and easy to move and position. If any of the levers become tight in operation, it may be necessary to lubricate the mechanism

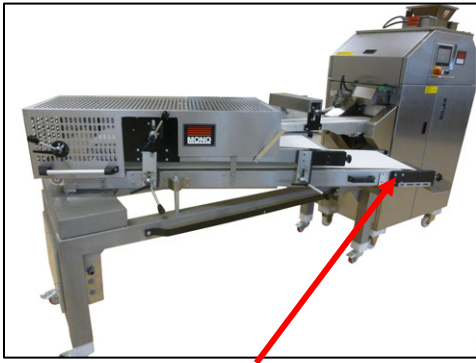

*Roll Forming Unit with Upper Belt Open*



*Support Cross Bar*

- Pull the Roll Forming Unit's Upper Belt mechanism to the open position to gain access to the Support Cross Bar which may need cleaning and lubricating from time to time

# 11. Recommended Cleaning Schedule:

- In order to maintain the high quality of roll production it is essential that regular cleaning of the Two-Pocket Roll Plant and Roll Forming Unit (if fitted) is carried out. Failure to do so may dramatically affect the quality of the output

		<h2 style="color: red;">Cleaning Schedule</h2> <p>Two-Pocket Roll Plant &amp; Roll Forming Unit (if fitted)</p>	
Part		Daily	Weekly
	Flour Dusters		
	Hopper System		 
	Pre-Scaler	 	
	Filling Chamber & Piston System	 	
	Drum & Rounder	 	
	Roller & Brushes	 	
	Roll Forming Unit	  	
	All External Surfaces	 	
	All Internal Surfaces		
<b>Cleaning Materials:</b>			
			
<b>Brush</b>	<b>Scraper</b>	<b>Vacuum Cleaner</b>	<b>Damp Cloth</b>
	<ul style="list-style-type: none"> <li>- Always ensure that the machine is switched OFF at the mains power supply before any cleaning or maintenance work takes place</li> <li>- Before beginning daily work, start the machine for 2-3 minutes without dough to ensure any loose residue is dislodged from the system</li> </ul>		

**Note:**



- Before beginning any type of maintenance or cleaning ensure the machine is disconnected from the mains power supply.
- If vacuuming ensure only an appropriate ATEX approved Safety Vacuum Cleaner is used to avoid the potential flour combustion
- A copy of the above Cleaning Schedule can also be found on the inside of the right hand door of the Two –Pocket Roll Plant

## 12. Manual Operation – Power OFF:

- With the help of a crank handle, the drive can be rotated manually with the power off
- The manual crank handle is clipped to the machine behind the end safety door. It should be unclipped and inserted into the drive in the side of the machine.
- When turning, the correct machine rotation direction is "left" (direction of arrow below).
- Remove Handle and Replace in the Clips Before Turning Power on.

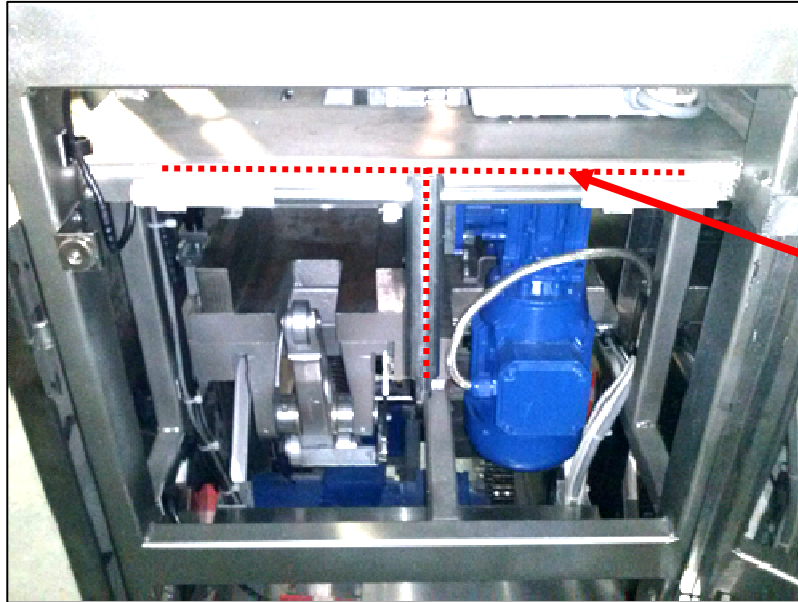

*Manual Crank Handle  
(Stowed)*

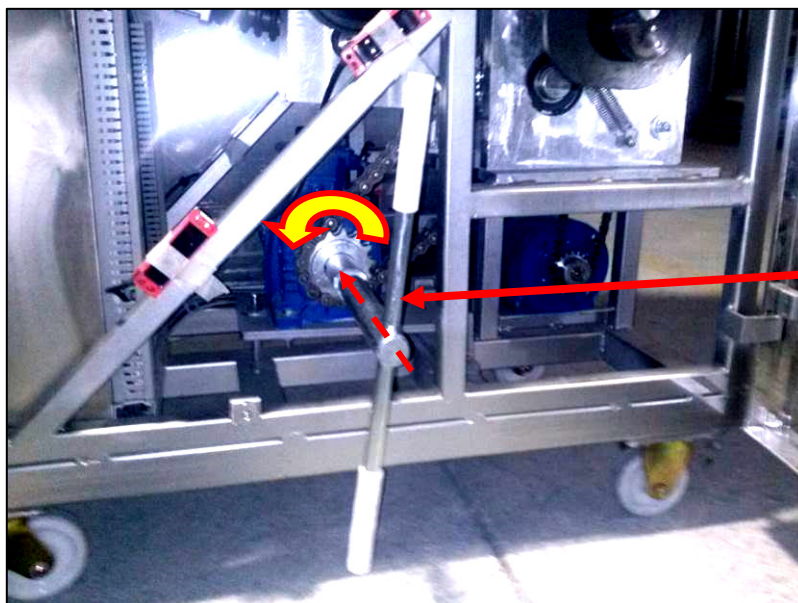

*Manual Crank Handle  
(Working Position)*

## 13. Hints & Tips:

---

- ✓ For best results, ensure the dough piece is gently stretched into an elongated shape before loading into the Hopper
- ✓ For best results, it is advised not to cut the dough into too many pieces
- ✓ The Product Recipe settings on Two-Pocket Roll Plant are based on the current QPIG which are the optimum settings to produce the best quality product
- ✓ Always check the weight of the dough pieces at the start of production and tweak the settings if required. Continue to check the weights at regular intervals to ensure consistency
- ✓ Transfer the Roll Forming Unit values from the Screen to the actual belt settings to ensure the correct shape is achieved before operating the machine.
- ✓ For finger roll production, ensure that the Upper Belt runs at a faster speed than the Lower Belt
- ✓ The Two-Pocket Roll Plant and Roll Forming Unit works well with a wide range of doughs and it shouldn't be necessary to remove water from the recipes in order for it to work effectively
- ✓ The Two-Pocket Roll Plant and Roll Forming Unit have been designed to provide full access to the internal workings for thorough cleaning
- ✓ As flour dust can be highly combustible please ensure ONLY an ATEX approved Safety Vacuum Cleaner is used for cleaning purposes
- ✓ For a quick guide to the cleaning process refer to the Cleaning Schedule which can be found on the inside of the left hand door of the main Two-Pocket Roll Plant

# 14. Electrical Information – Roll Plant:



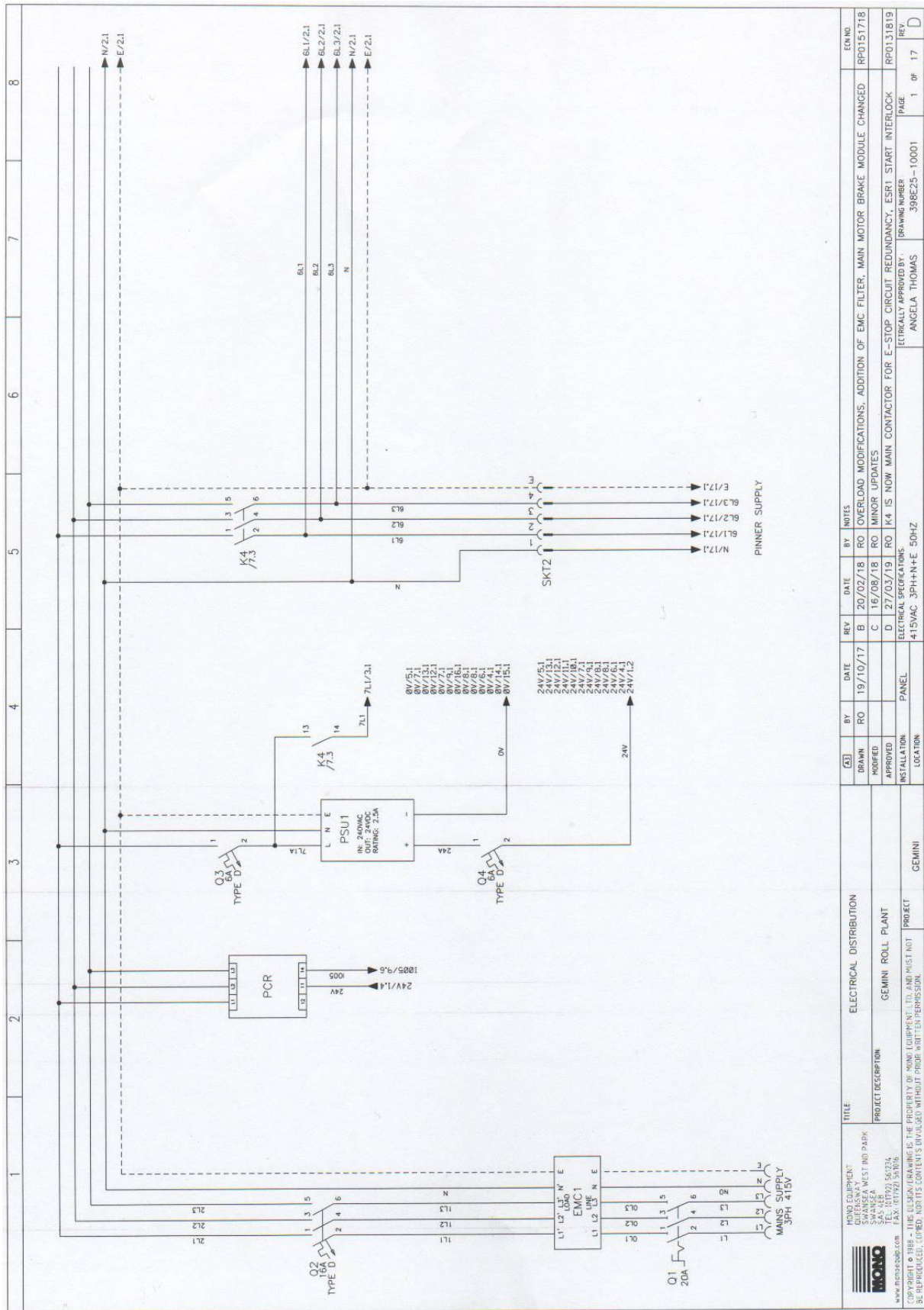

MONO EQUIPMENT		TITLE		REV		DATE		BY		NOTES		E/CN NO	
QUERKSNAY WEST IND PARK SWANSEA SAS HER 001 66374 www.monozoo.com FAX: 01792 58306		ELECTRICAL DISTRIBUTION		RO	19/10/17	B	20/02/18	RO	20/02/18	RO	ADDITION OF EMC FILTER, MAIN MOTOR BRAKE MODULE CHANGED	RP0151718	
MONO		PROJECT DESCRIPTION		APPROVED		C	16/08/18	RO	16/08/18	RO	MINOR UPDATES	RP0131819	
COPYRIGHT © 1988 - THIS DRAWING IS THE PROPERTY OF MONO EQUIPMENT LTD. AND MUST NOT BE REPRODUCED, COPIED, NOR ITS CONTENTS DISCLOSED WITHOUT PRIOR WRITTEN PERMISSION.		GEMINI ROLL PLANT		INSTALLATION	PANEL	D	27/03/19	RO	K4 IS NOW MAIN CONTACTOR FOR E-STOP CIRCUIT REDUNDANCY. ESR1 START INTERLOCK	ELECTRICAL SPECIFICATIONS: 415VAC, 3PH+H+E, 50HZ		PAGE	
		PROJECT		LOCATION				DRAWING NUMBER		398E25-10001		REV	
		GEMINI						ANGELA THOMAS		1 OF 17		D	





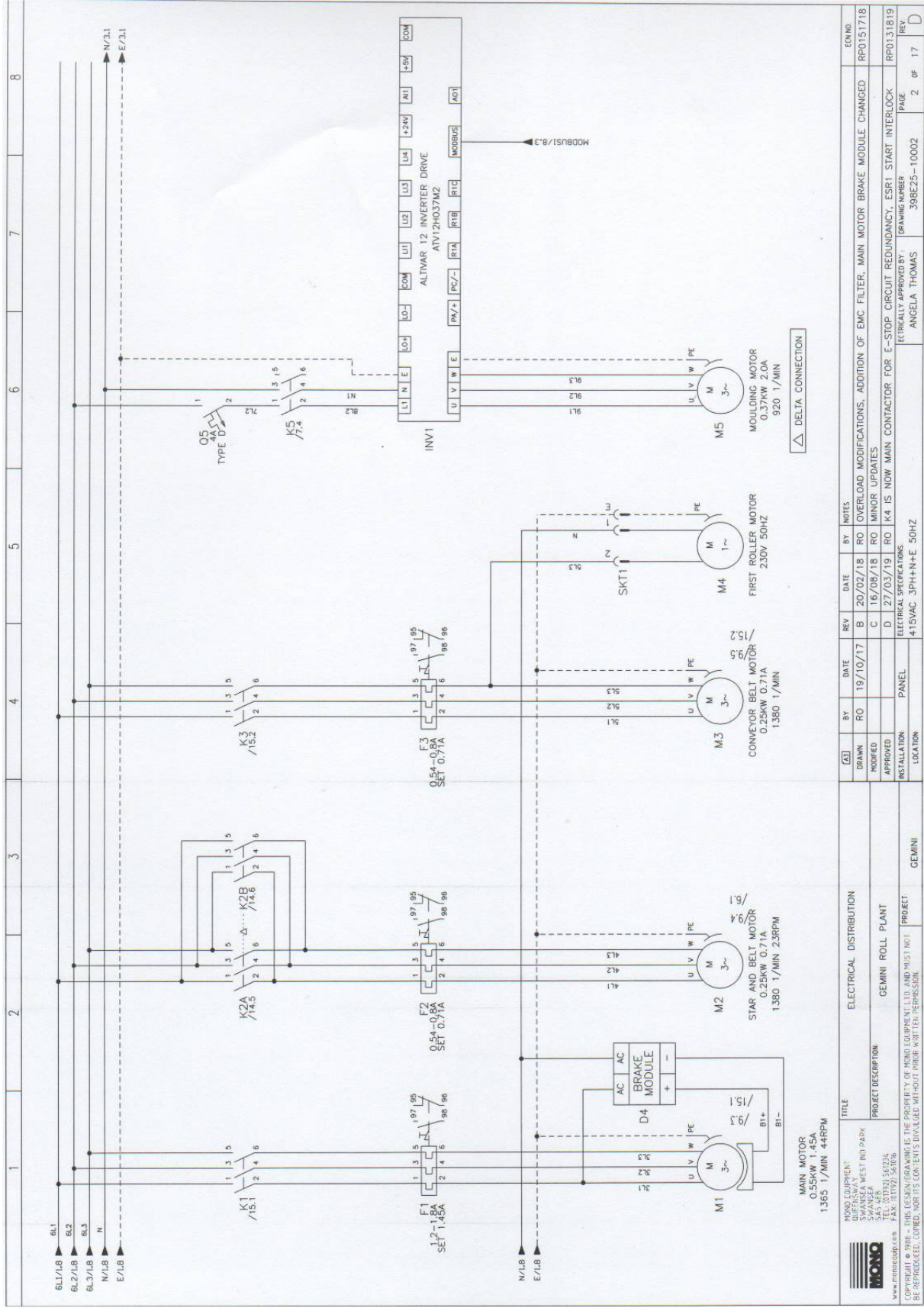

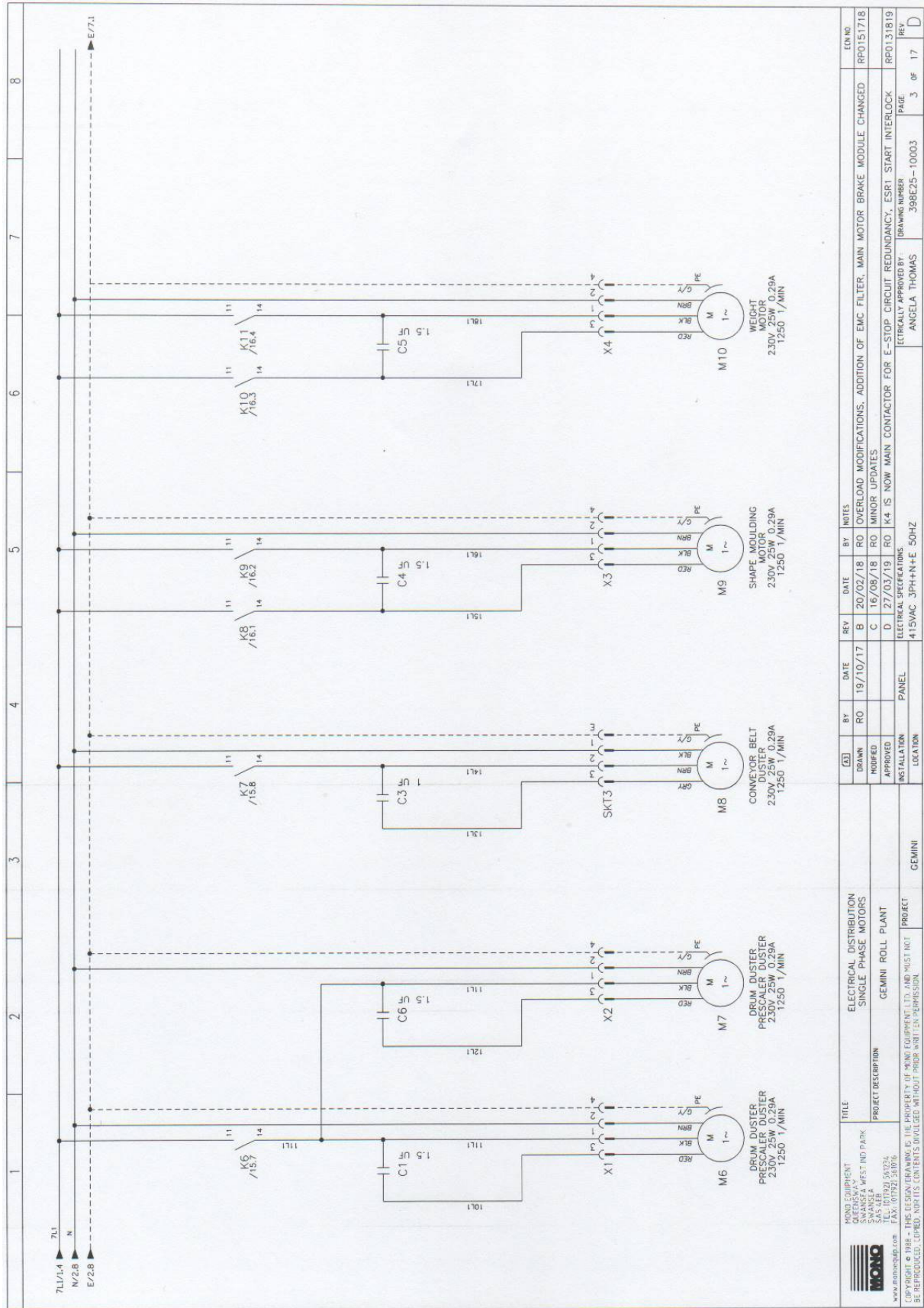

MONO EQUIPMENT		TITLE		BY		REV		DATE		NOTES		E/CN NO		
QUEENSWAY WEST IND PARK SWANSEA S45 4EP www.monoquip.com FAX: 01792 561016		ELECTRICAL DISTRIBUTION SINGLE PHASE MOTORS		RO	RO	B	C	19/10/17	20/02/18	16/08/18	RO OVERLOAD MODIFICATIONS; ADDITION OF EMC FILTER; MAIN MOTOR BRAKE MODULE CHANGED	RP0151718		
		PROJECT DESCRIPTION		APPROVED	DRAWN	D	D				RO MINOR UPDATES	RP0131819		
		GEMINI ROLL PLANT		INSTALLATION	PANEL			27/03/19			K4 IS NOW MAIN CONTACTOR FOR E-STOP CIRCUIT REDUNDANCY. ESRI START INTERLOCK	3	17	
		GEMINI		LOCATION							ELECTRICAL SPECIFICATIONS 415VAC 3PH+1N+E 50HZ	388225-10003	3	17
											TERRICALLY APPROVED BY ANGELA THOMAS	REV	3	17
												D		



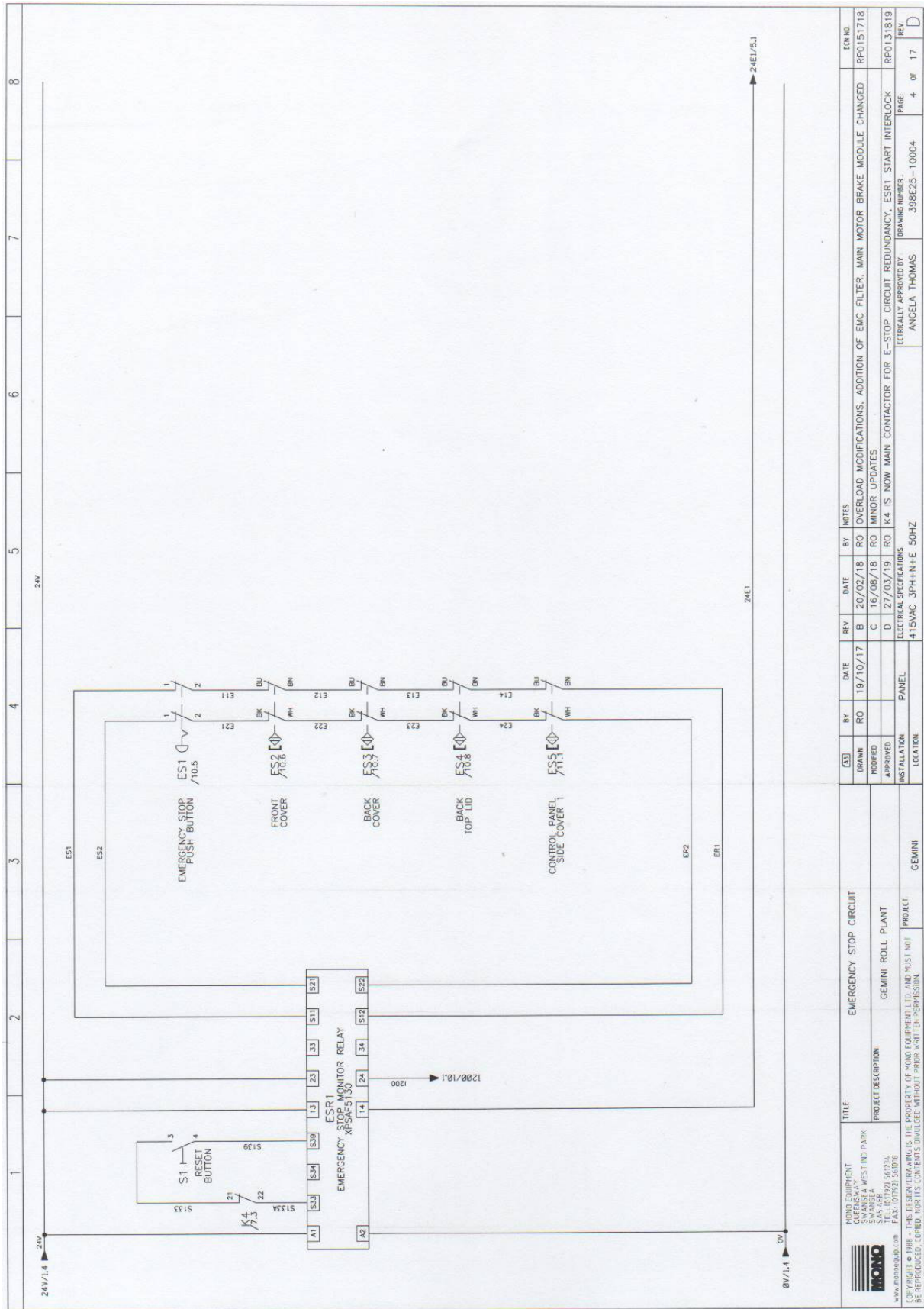

MONO EQUIPMENT		TITLE		REV		DATE		BY		NOTES		EON NO	
GREENSBAY WEST END PARK SWANSEA		EMERGENCY STOP CIRCUIT		RO	19/10/17	B	20/02/18	RO	OVERLOAD MODIFICATIONS, ADDITION OF EMC FILTER, MAIN MOTOR BRAKE MODULE CHANGED	RP0151718		RP0151718	
S45 HER 001 547324 www.monogroup.com FAX: 01792 363976		PROJECT DESCRIPTION		MODIFIED		C	16/08/18	RO	MINOR UPDATES	PAGE		4 OF 17	
COPYRIGHT © THIS - THIS DESIGN DRAWING IS THE PROPERTY OF MONO EQUIPMENT LTD. AND MUST NOT BE REPRODUCED, COPIED, NOR ITS CONTENTS DIVULGED WITHOUT WRITTEN PERMISSION.		PROJECT		APPROVED		D	27/03/19	RO	K4 IS NOW MAIN CONTACTOR FOR E-STOP CIRCUIT REDUNDANCY, ESR1 START INTERLOCK	DRAWING NUMBER		398E23-10004	
		GEMINI		INSTALLATION	PANEL	ELECTRICAL SPECIFICATIONS		TECHNICALLY APPROVED BY:		ANGELA THOMAS		REV D	
						4 IS MAC 3PH+N+E 50HZ							



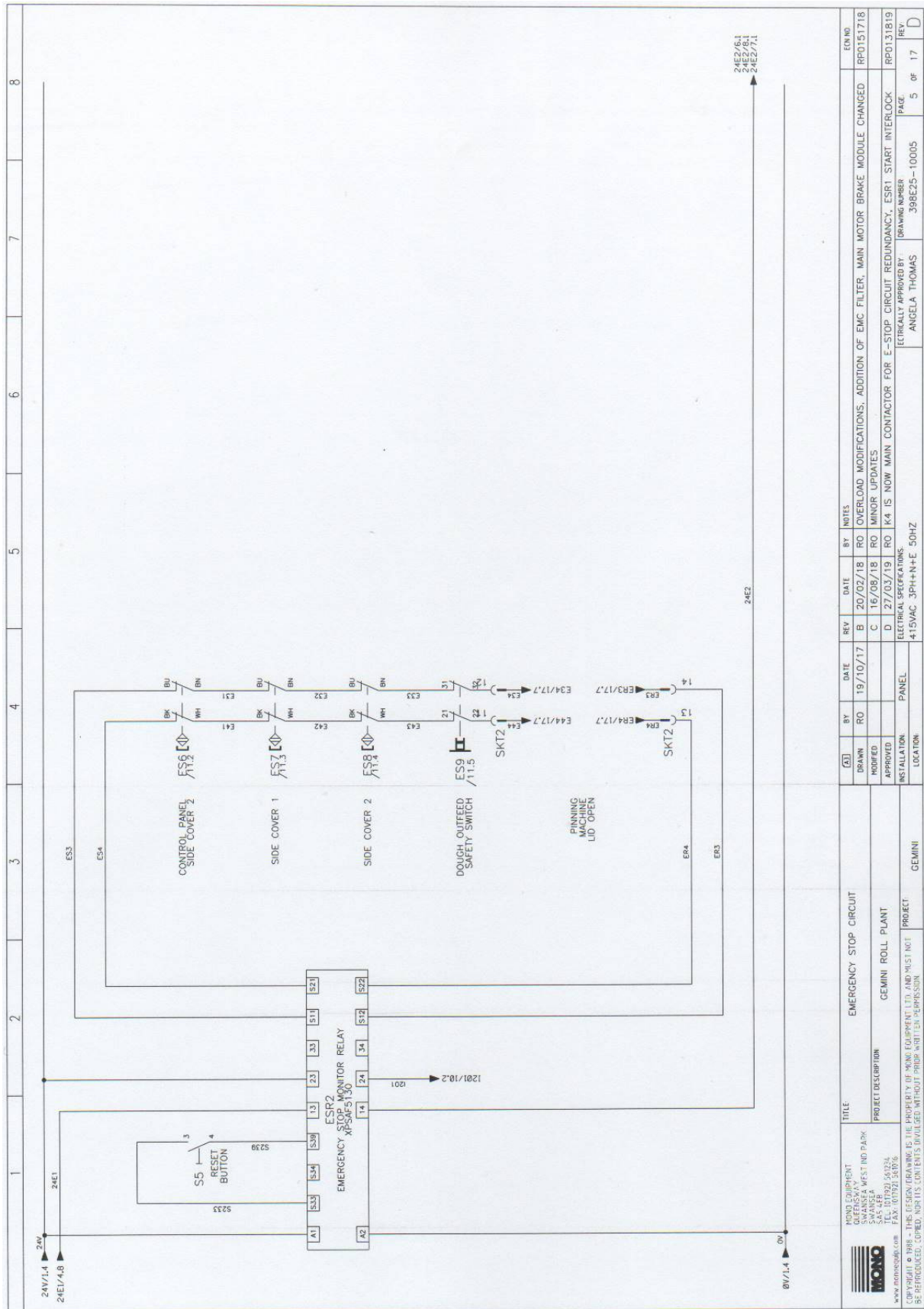

REV	DATE	BY	NOTES	ECN NO
B	20/02/18	RO	OVERLOAD MODIFICATIONS, ADDITION OF EMC FILTER, MAIN MOTOR BRAKE MODULE CHANGED	RP0151718
C	16/08/18	RO	MINOR UPDATES	
D	27/03/19	RO	K4 IS NOW MAIN CONTACTOR FOR E-STOP CIRCUIT REDUNDANCY, ESR1 START INTERLOCK	RP0131819
TECHNICAL SPECIFICATIONS				REV
415VAC, 3PH+NE, 50HZ				REV
APPROVED BY				REV
ANGELA THOMAS				REV
PAGE				REV
398E2S-1000S				REV
5 of 17				REV
D				REV

  

DATE	BY	LOCATION	TITLE
19/10/17	RO	PANEL	EMERGENCY STOP CIRCUIT
	RO	GEMINI	GEMINI ROLL PLANT
			PROJECT DESCRIPTION
			GEMINI ROLL PLANT
			PROJECT
			AND MUST NOT
			PERMISSION
			BE REPRODUCED, COPIED, NOR ITS CONTENTS DIVULGED WITHOUT WRITTEN PERMISSION

MONO EQUIPMENT QUEENSLAND'S WEST END PARK SWANSEA S45 UER 031 541324 S45 UER 031 541324 FAX: 037521 581036 www.monoequip.com	MONO
--	------



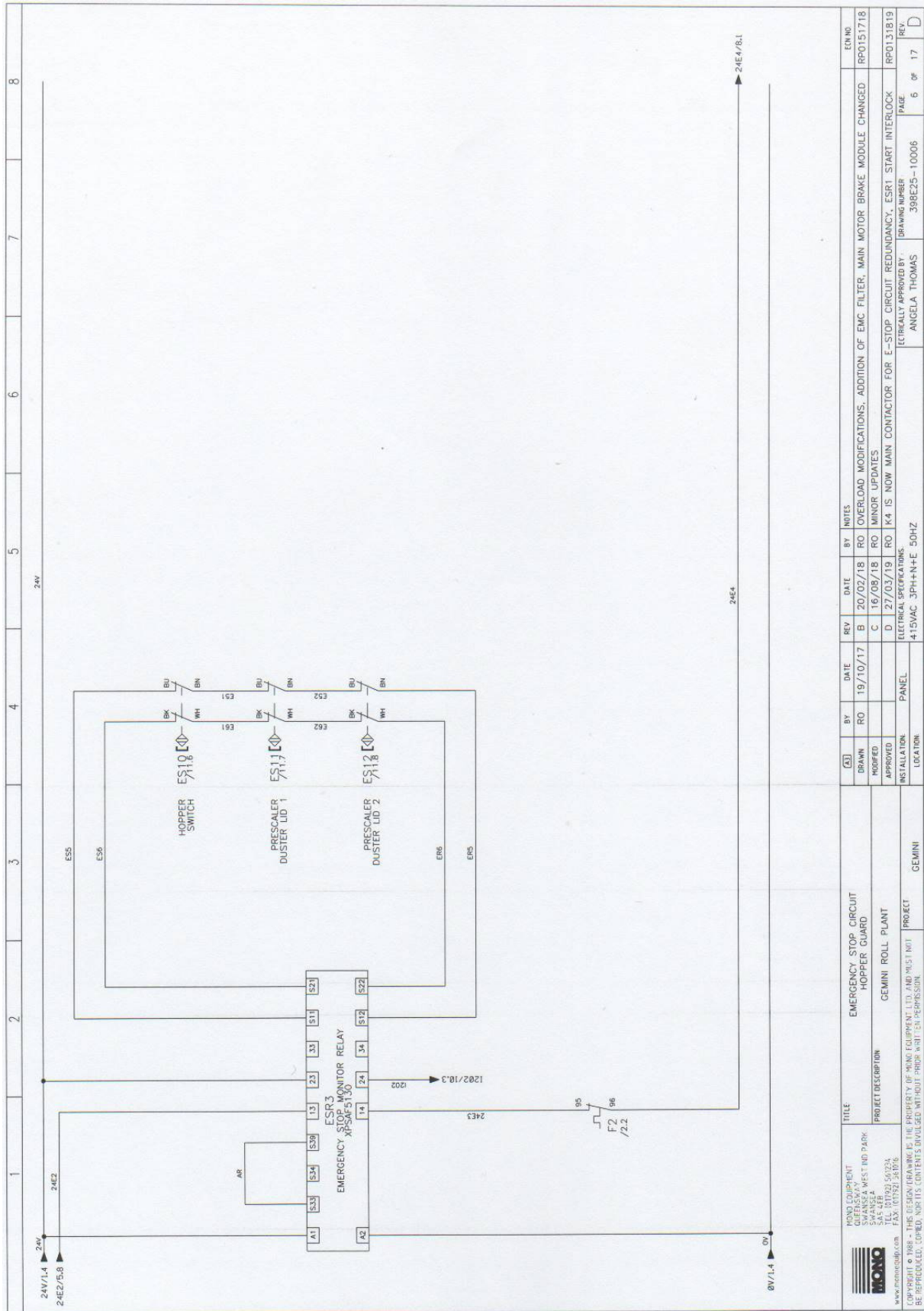

MONO EQUIPMENT		TITLE		BY		DATE		REV		NOTES		EON NO	
MONO EQUIPMENT QUEENSLAND WEST END PARK SWANSEA SAS UNIT 03 651734 SAS UNIT 04 651734 FAX: (07) 552 24 006 www.monoquip.com		EMERGENCY STOP CIRCUIT HOPPER GUARD		RO	19/10/17	B	20/02/18	RO	OVERLOAD MODIFICATIONS, ADDITION OF EMC FILTER, MAIN MOTOR BRAKE MODULE CHANGED	RP0151718			RP0151718
		PROJECT DESCRIPTION GEMINI ROLL PLANT		RO	16/08/18	C	16/08/18	RO	MINOR UPDATES				
		PROJECT GEMINI		RO	27/03/19	D	27/03/19	RO	K4 IS NOW MAIN CONTACTOR FOR E-STOP CIRCUIT REDUNDANCY, ESR1 START INTERLOCK	RP0131819			RP0131819
		INSTALLATION		LOCATION				ELECTRICAL SPECIFICATIONS 4.15VAC 3PH 4N+E 50HZ				PAGE 6 of 17	
								TECHNICALLY APPROVED BY ANGELA THOMAS				DRAWING NUMBER 388235-10006	
												REV D	



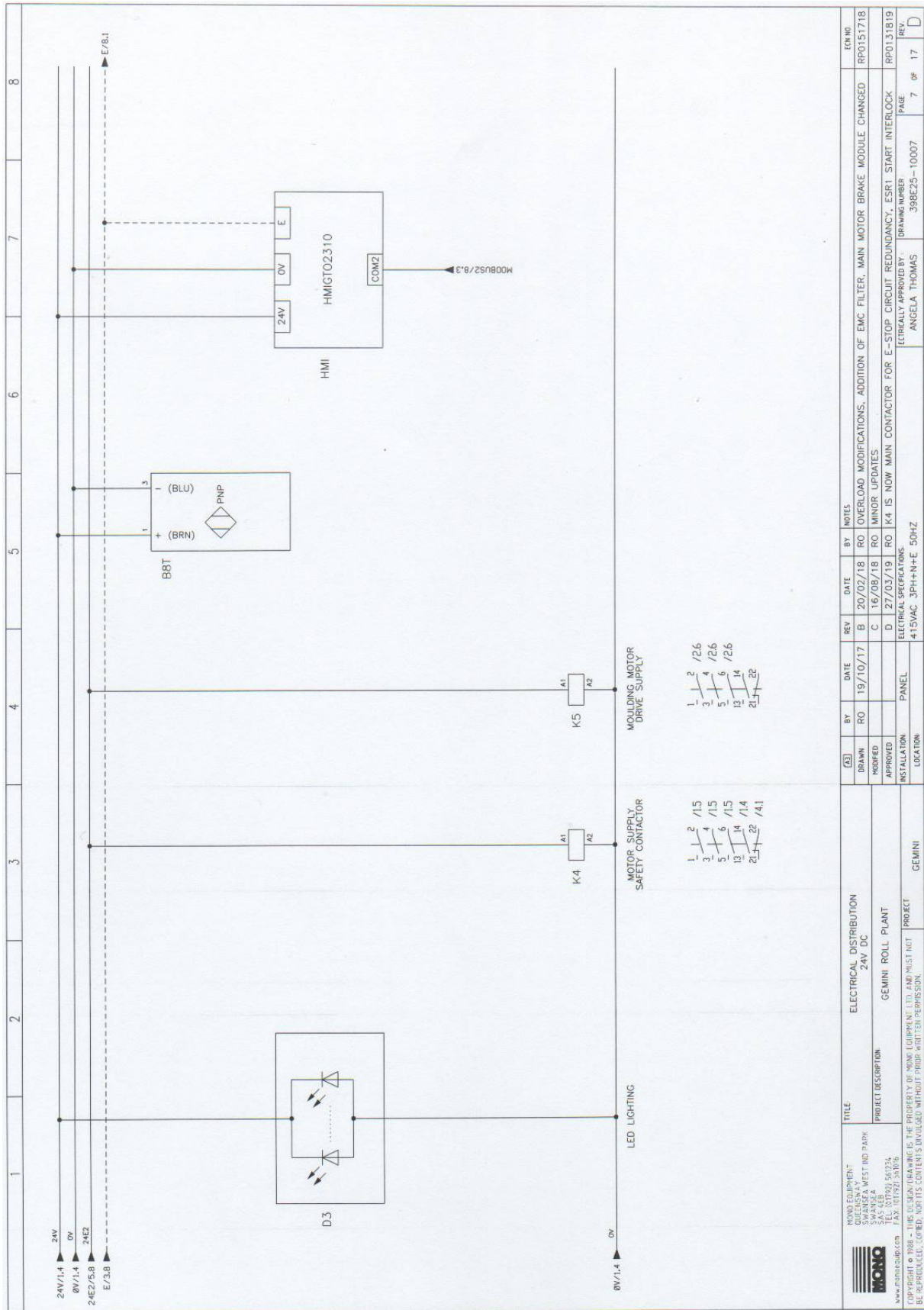

MONO EQUIPMENT		TITLE		REV		DATE		BY		NOTES		EQUIP NO	
QUEENSLAND WEST IND PARK SWANSEA		ELECTRICAL DISTRIBUTION		RO	19/10/17	B	20/02/18	RO	20/02/18	RO	OVERLOAD MODIFICATIONS, ADDITION OF EMC FILTER, MAIN MOTOR BRAKE MODULE CHANGED	RP0151718	
SAS TEL 081 545734		GEMINI ROLL PLANT		RO		C	16/08/18	RO		RO	MINOR UPDATES	RP0131819	
www.monosolab.com		PROJECT DESCRIPTION		APPROVED		D	27/03/19	RO		RO	K4 IS NOW MAIN CONTACTOR FOR E-STOP CIRCUIT REDUNDANCY, ESR1 START INTERLOCK	REV	
COPYRIGHT © 1988 - THIS DOCUMENT REMAINS THE PROPERTY OF MONO EQUIPMENT LTD. AND MUST NOT BE REPRODUCED, COPIED, NOR ITS CONTENTS DISCLOSED WITHOUT PRIOR WRITTEN PERMISSION.		PROJECT		INSTALLATION		ELECTRICAL SPECIFICATIONS		PANEL		TECHNICALLY APPROVED BY		PAGE	
		GEMINI		LOCATION		415VAC, 3PH+HFE, 50HZ				ANGELA THOMAS		7 OF 17	
												D	



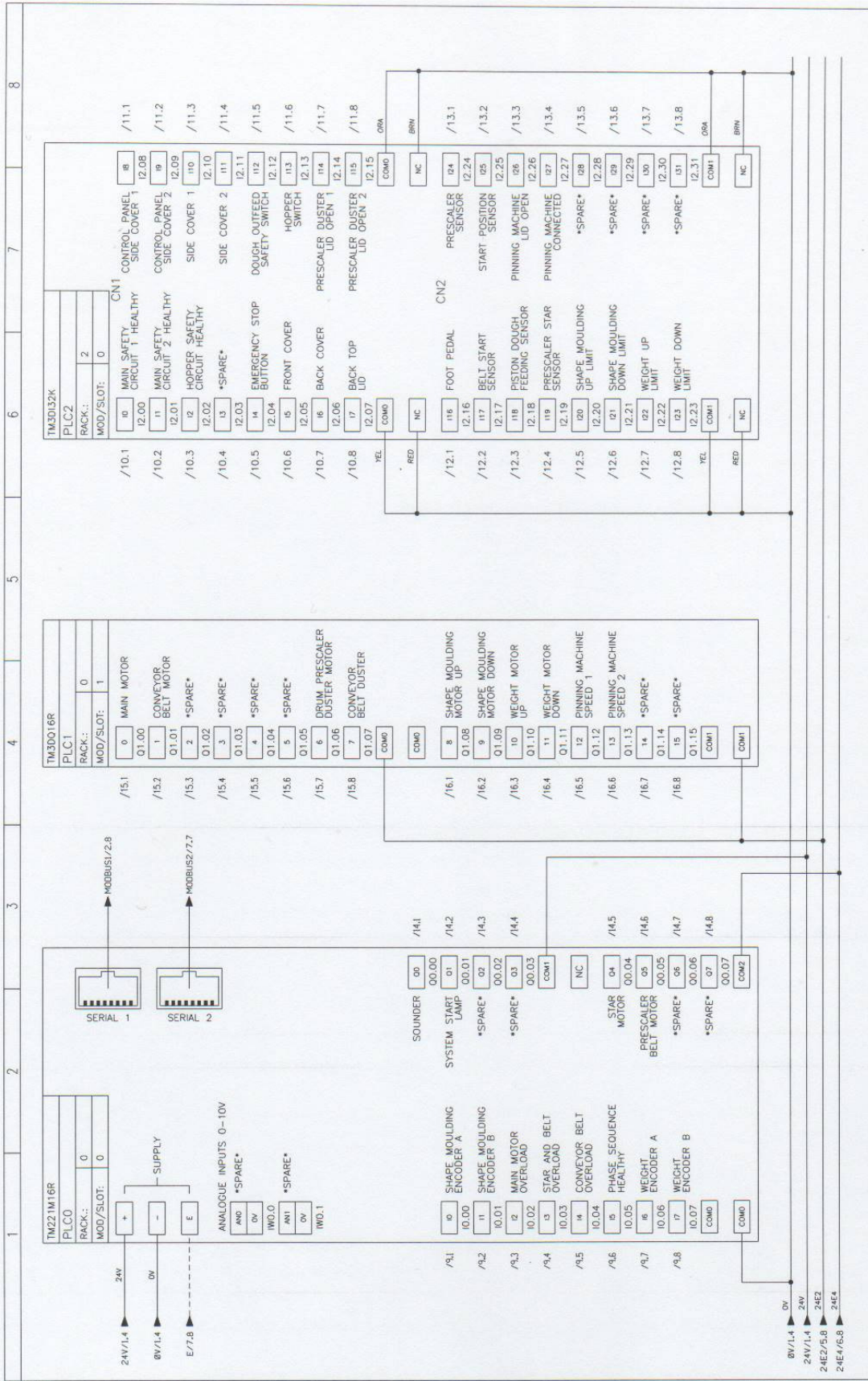

1 2 3 4 5 6 7 8

NO.	DATE	REV	BY	DATE	REV	BY	NOTES	ECN NO.
B	20/02/18	RO	OVERLOAD MODIFICATIONS, ADDITION OF EMC FILTER, MAIN MOTOR BRAKE MODULE CHANGED	RP0151718				
C	16/08/18	RO	MINOR UPDATES	RP0151718				
D	27/03/19	RO	K4 IS NOW MAIN CONTACTOR FOR E-STOP CIRCUIT REDUNDANCY, ESRI START INTERLOCK	RP0131819				

  

DESCRIPTION	LOCATION	DATE	BY
INSTALLATION	PANEL		
TECHNICAL APPROVED BY:	ANGELA THOMAS		
DRAWING NUMBER	39825-10008		
PAGE	8	OF	17

MODULE	NO.	DESCRIPTION	WIRING	TERMINAL
TM221M16R	0	MAIN MOTOR	/15.1	01.00
	1	CONVEYOR BELT MOTOR	/15.2	01.01
	2	*SPARE*	/15.3	01.02
	3	*SPARE*	/15.4	01.03
	4	*SPARE*	/15.5	01.04
	5	*SPARE*	/15.6	01.05
	6	DRUM, PRESCALER DUSTER MOTOR	/15.7	01.06
	7	CONVEYOR BELT DUSTER	/15.8	01.07
	COMO			
	COMO			
TM3D016R	8	SHAPE MOULDING MOTOR UP	/16.1	01.08
	9	SHAPE MOULDING MOTOR DOWN	/16.2	01.09
	10	WEIGHT MOTOR UP	/16.3	01.10
	11	WEIGHT MOTOR DOWN	/16.4	01.11
	12	PINNING MACHINE SPEED 1	/16.5	01.12
	13	PINNING MACHINE SPEED 2	/16.6	01.13
	14	*SPARE*	/16.7	01.14
	15	*SPARE*	/16.8	01.15
	COMO			
	COMO			
TM3D012K	10	MAIN SAFETY CIRCUIT 1 HEALTHY	/10.1	12.00
	11	MAIN SAFETY CIRCUIT 2 HEALTHY	/10.2	12.01
	12	HOPPER SAFETY CIRCUIT HEALTHY	/10.3	12.02
	13	*SPARE*	/10.4	12.10
	14	EMERGENCY STOP BUTTON	/10.5	12.11
	15	FRONT COVER	/10.6	12.12
	16	BACK COVER	/10.7	12.13
	17	BACK TOP LID	/10.8	12.14
	COMO			
	COMO			



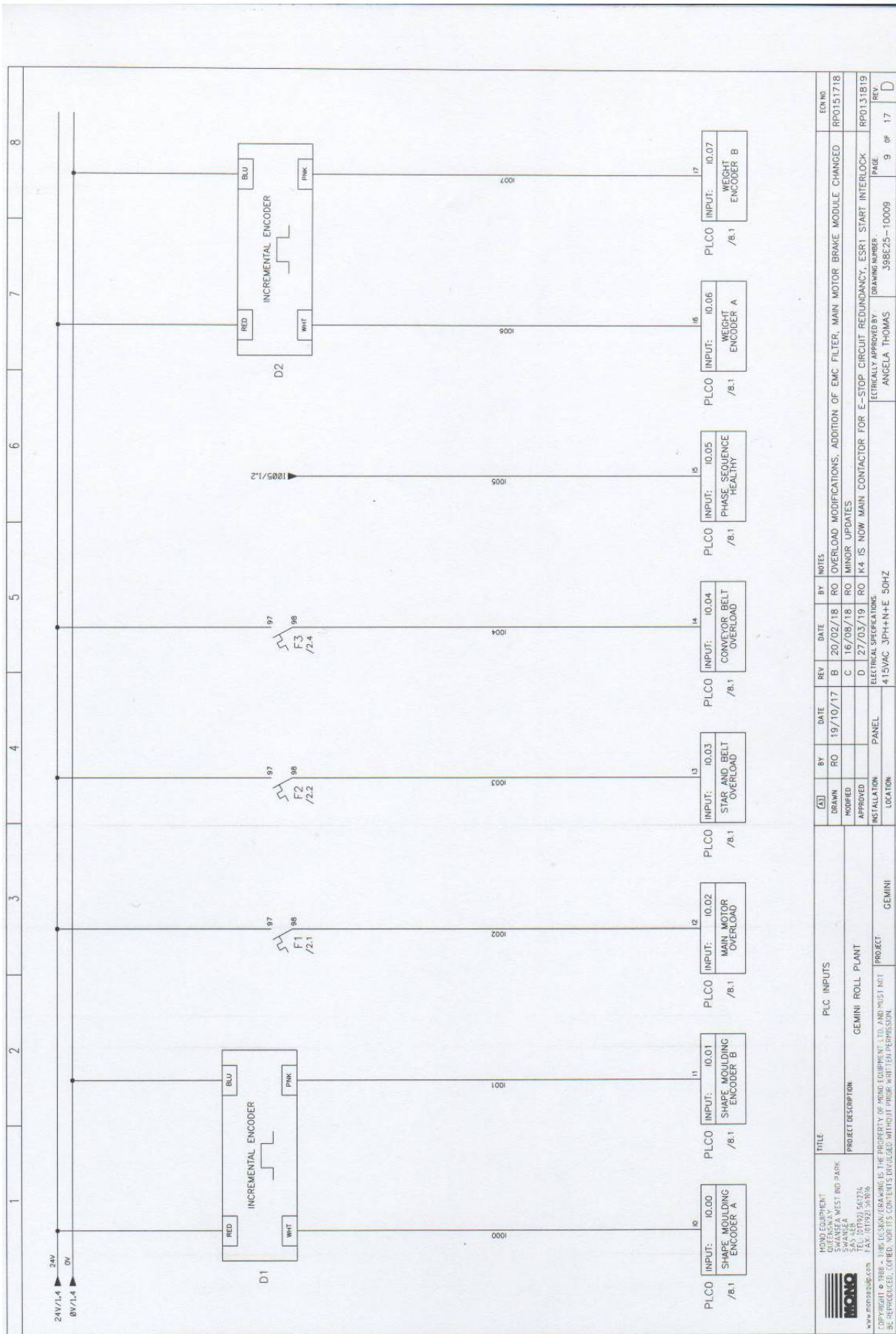

REV	DATE	BY	DATE	REV	DATE	BY	NOTES	ECN NO
B	20/02/18	RO	19/10/17	B	20/02/18	RO	OVERLOAD MODIFICATIONS, ADDITION OF EMC FILTER, MAIN MOTOR BRAKE MODULE CHANGED	RP015718
C	16/08/18	RO		C	16/08/18	RO	MINOR UPDATES	
D	27/03/19	RO		D	27/03/19	RO	K4 IS NOW MAIN CONTACTOR FOR E-STOP CIRCUIT REDUNDANCY, ESR1 START INTERLOCK	RP0131819

<table border="1"> <tr> <td>DRAWN</td> <td></td> </tr> <tr> <td>APPROVED</td> <td></td> </tr> </table>	DRAWN		APPROVED		<table border="1"> <tr> <td>INSTALLATION</td> <td>PANEL</td> </tr> <tr> <td>LOCATION</td> <td>GEMINI</td> </tr> </table>	INSTALLATION	PANEL	LOCATION	GEMINI
DRAWN									
APPROVED									
INSTALLATION	PANEL								
LOCATION	GEMINI								
TITLE: MONO EQUIPMENT GEMINI ROLL PLANT									
PROJECT DESCRIPTION: GEMINI ROLL PLANT									
PROJECT: GEMINI									

MONO EQUIPMENT QUEENSLAND WEST END PARK SWANSEA SAS 5138 001 561734 FAX: 011921 261619 www.monoside.com	ELECTRICAL SPECIFICATIONS 415VAC, 3PH+H+NE, 50HZ
COPYRIGHT © 1988 - THE USUKAN DRAWING IS THE PROPERTY OF MONO EQUIPMENT LTD. AND MUST NOT BE REPRODUCED, COPIED, NOR ITS CONTENTS DIVULGED WITHOUT PRIOR WRITTEN PERMISSION.	TECHNICALLY APPROVED BY: ANGELA THOMAS DRAWING NUMBER: 398E25-10009
PAGE: 9 OF 17	REV: D





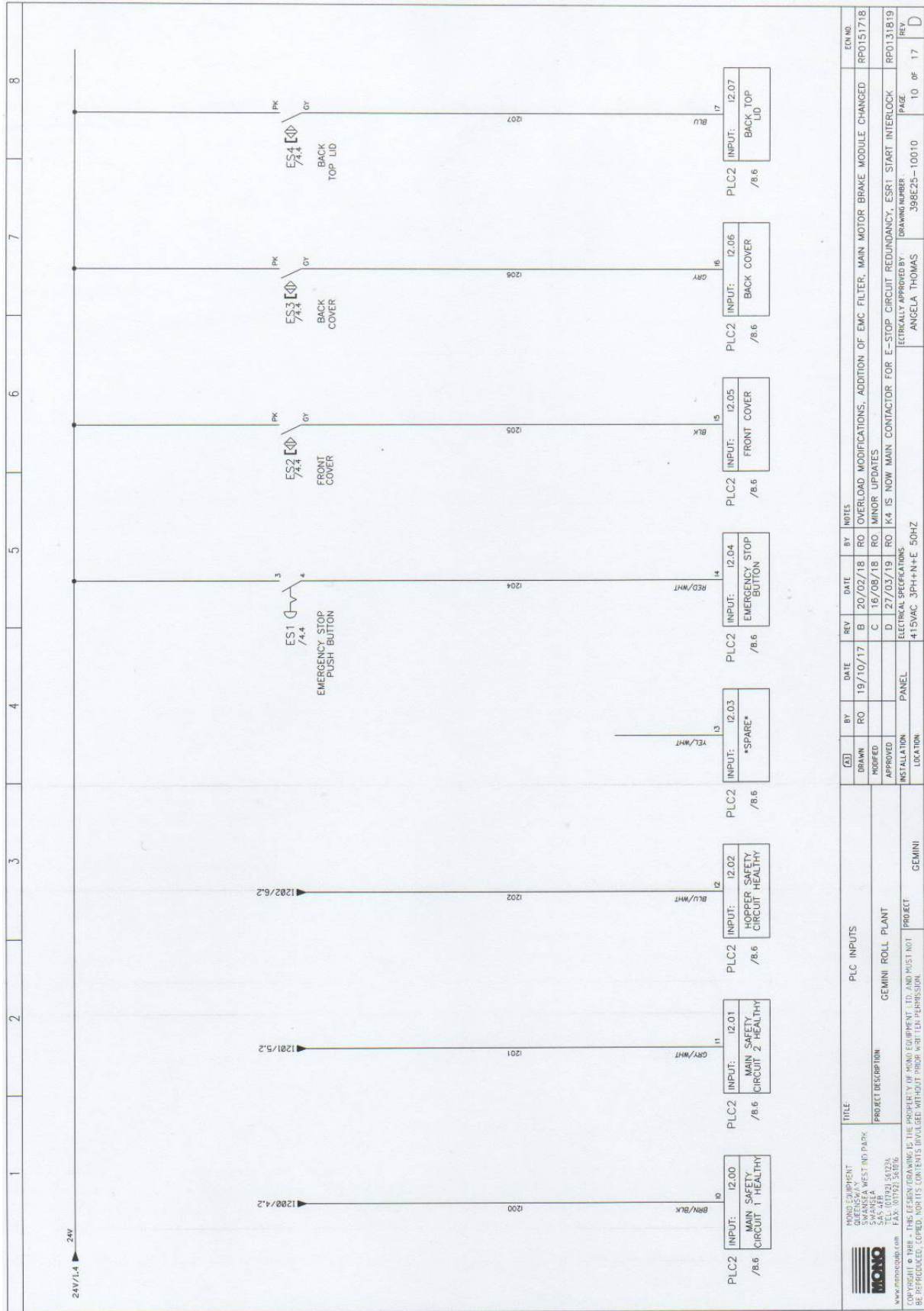

MONO EQUIPMENT		TITLE		BY		DATE		REV		DATE		BY		NOTES		ECN NO.	
QUEENSLAND WEST RD PARK SWANSEA		PLC INPUTS		RO	RO	19/10/17	19/10/17	B	20/02/18	RO	20/02/18	RO	20/02/18	RO	OVERLOAD MODIFICATIONS; ADDITION OF EMC FILTER; MAIN MOTOR BRAKE MODULE CHANGED	RP0151718	
SAS 4/101 54124		GEMINI ROLL PLANT		APPROVED	APPROVED			C	16/08/18	RO	16/08/18	RO	16/08/18	RO	MINOR UPDATES	RP0131819	
www.monocorp.com		PROJECT DESCRIPTION		INSTALLATION	INSTALLATION			D	27/03/19	RO	27/03/19	RO	27/03/19	RO	K4 IS NOW MAIN CONTACTOR FOR E-STOP CIRCUIT REDUNDANCY; ESRT START INTERLOCK	REV	
COPYRIGHT © 1988 - THIS DESIGN BEARING IS THE PROPERTY OF MONO EQUIPMENT LTD. AND MUST NOT BE REPRODUCED, COPIED, NOR ITS CONTENTS DIVULGED WITHOUT PRIOR WRITTEN PERMISSION.		PROJECT LOCATION		GEMINI										ELECTRICALLY APPROVED BY: ANGELA THOMAS		DRAWING NUMBER: 398E25-100110	
																PAGE: 10 OF 17	



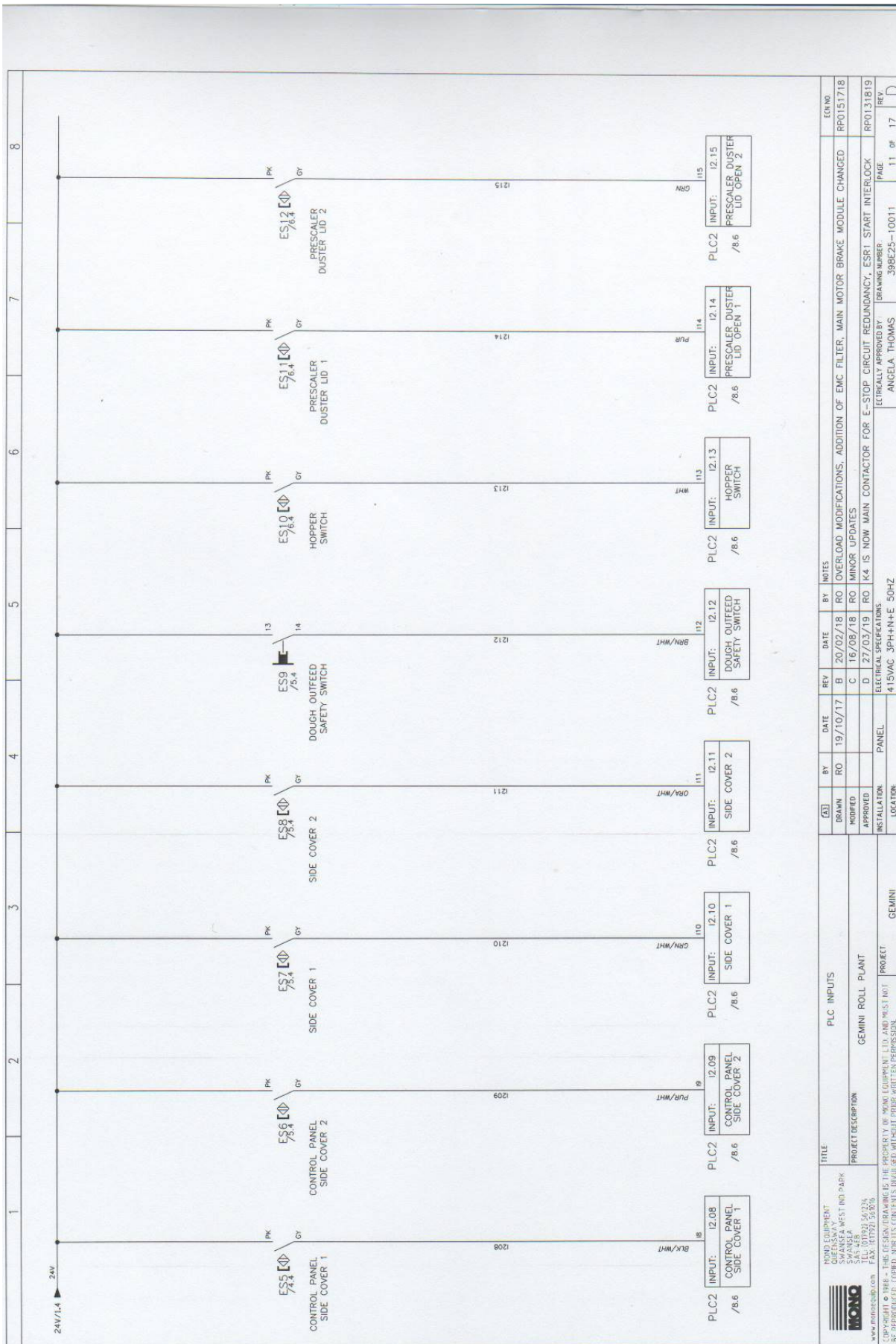

REV	DATE	BY	DATE	REV	DATE	BY	DATE	NOTES	REV	DATE	BY	DATE	NOTES	REV	DATE	BY	DATE	NOTES	
B	20/02/18	RO	19/10/17	B	20/02/18	RO	19/10/17	OVERLOAD MODIFICATIONS, ADDITION OF EMC FILTER, MAIN MOTOR BRAKE MODULE CHANGED											
C	16/08/18	RO		C	16/08/18	RO		MINOR UPDATES											
D	27/03/19	RO		D	27/03/19	RO		K4 IS NOW MAIN CONTACTOR FOR E-STOP CIRCUIT REDUNDANCY, ESR1 START INTERLOCK											
E				E				ELECTRICAL SPECIFICATIONS											
								4 ISVAC 3PH-4HE 50HZ											



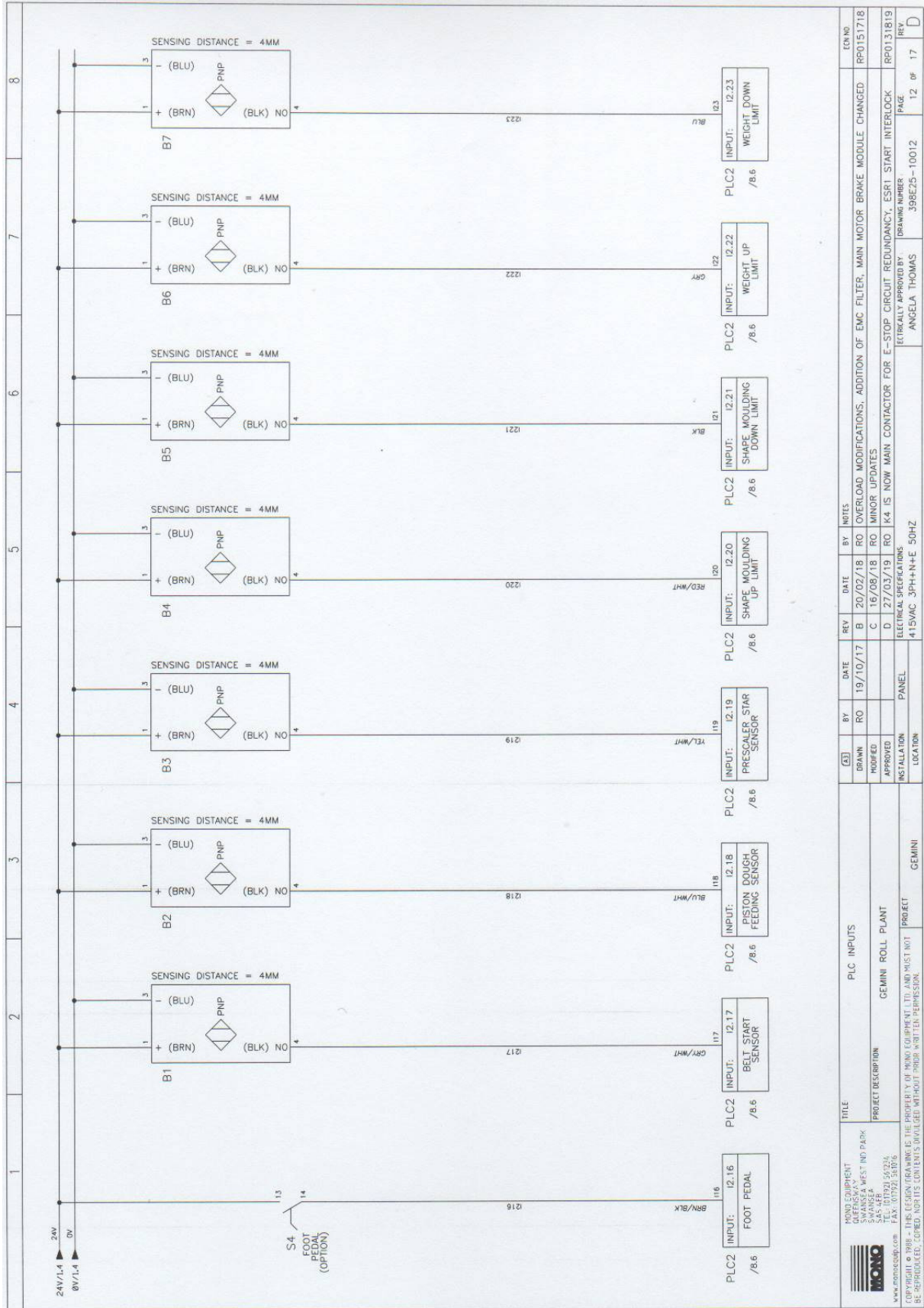

PLC2 INPUT		DATE	REV	BY	NOTES
12.16	FOOT PEDAL				
12.17	BELT START SENSOR				
12.18	PISTON DOUGH FEEDING SENSOR	19/10/17	B	RO	OVERLOAD MODIFICATIONS, ADDITION OF EMC FILTER, MAIN MOTOR BRAKE MODULE CHANGED
12.19	PRESCALE STAR SENSOR	16/08/18	C	RO	MINOR UPDATES
12.20	SHAPE MOULDING UP LIMIT	27/03/19	D	RO	K4 IS NOW MAIN CONTACTOR FOR E-STOP CIRCUIT REDUNDANCY, ESRI START INTERLOCK
12.21	SHAPE MOULDING DOWN LIMIT				
12.22	WEIGHT UP LIMIT				
12.23	WEIGHT DOWN LIMIT				

  

ENCL NO	REV	DATE	BY	NOTES
RP0151718				
RP0131819				

DESCRIPTION	LOCATION
MONO EQUIPMENT QUEENSLAND WEST END PARK SWANSEA	GEMINI
PROJECT DESCRIPTION	GEMINI ROLL PLANT
INSTALLATION	PANEL
TECHNICALLY APPROVED BY	ANGELA THOMAS
DRAWING NUMBER	39823-10012
PAGE	12 OF 17
REV	D



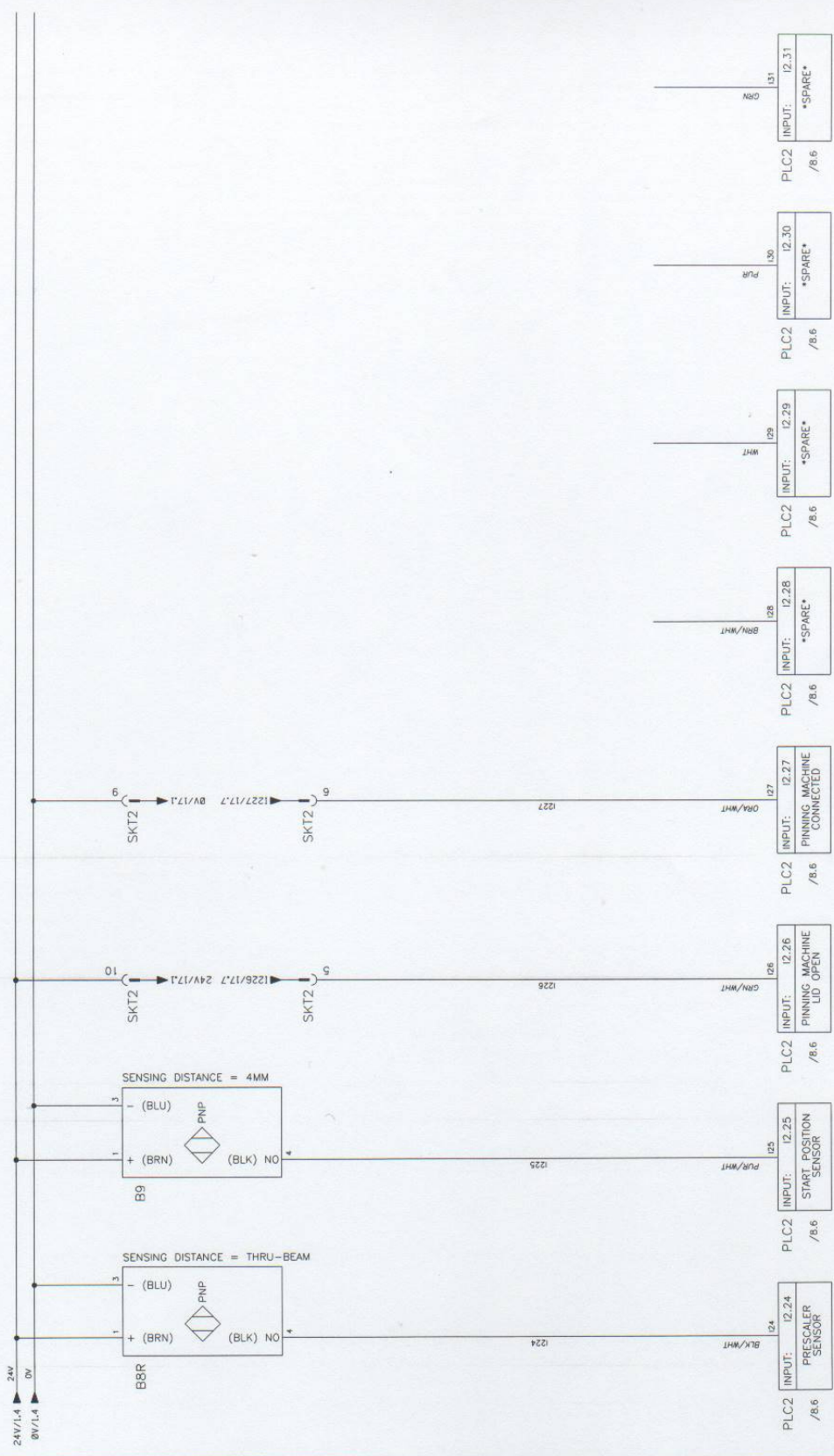

PLC2 INPUT:	DATE	BY	NOTES
12.24	19/10/17	RO	RO OVERLOAD MODIFICATIONS, ADDITION OF EMC FILTER, MAIN MOTOR BRAKE MODULE CHANGED
12.25	16/08/18	RO	MINOR UPDATES
12.26	27/03/19	RO	K4 IS NOW MAIN CONTACTOR FOR E-STOP CIRCUIT REDUNDANCY; ES1 START INTERLOCK
12.27			ELECTRICAL SPECIFICATIONS
12.28			415VAC, 3PH+N+E 50HZ
12.29			
12.30			
12.31			

PLC2 INPUT:	DATE	BY	NOTES
12.24	19/10/17	RO	RO OVERLOAD MODIFICATIONS, ADDITION OF EMC FILTER, MAIN MOTOR BRAKE MODULE CHANGED
12.25	16/08/18	RO	MINOR UPDATES
12.26	27/03/19	RO	K4 IS NOW MAIN CONTACTOR FOR E-STOP CIRCUIT REDUNDANCY; ES1 START INTERLOCK
12.27			ELECTRICAL SPECIFICATIONS
12.28			415VAC, 3PH+N+E 50HZ
12.29			
12.30			
12.31			

PLC2 INPUT:	DATE	BY	NOTES
12.24	19/10/17	RO	RO OVERLOAD MODIFICATIONS, ADDITION OF EMC FILTER, MAIN MOTOR BRAKE MODULE CHANGED
12.25	16/08/18	RO	MINOR UPDATES
12.26	27/03/19	RO	K4 IS NOW MAIN CONTACTOR FOR E-STOP CIRCUIT REDUNDANCY; ES1 START INTERLOCK
12.27			ELECTRICAL SPECIFICATIONS
12.28			415VAC, 3PH+N+E 50HZ
12.29			
12.30			
12.31			



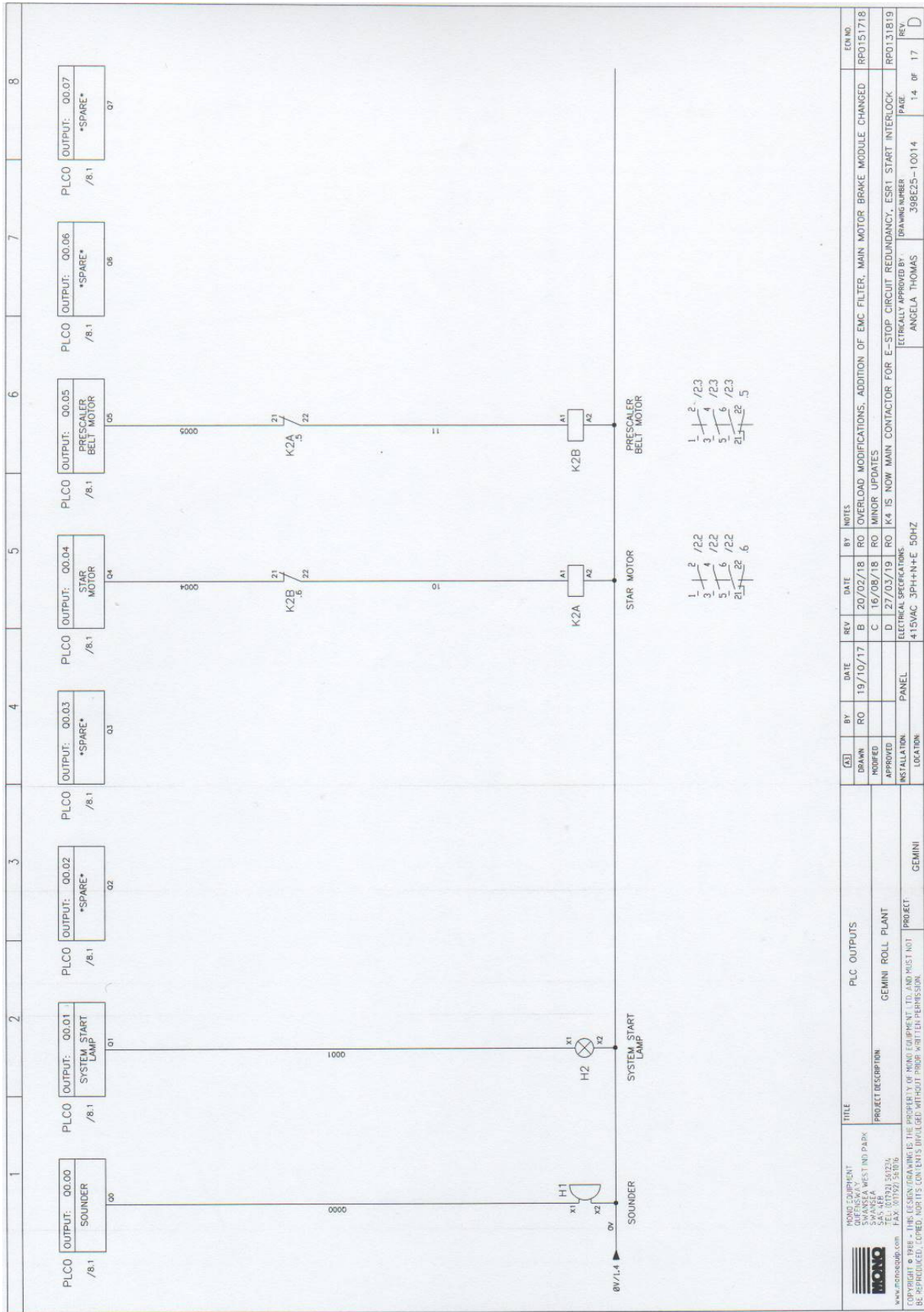

MONO EQUIPMENT		PLC OUTPUTS		BY		DATE		REV		NOTES		EON NO.	
GEMINI ROLL PLANT		GEMINI ROLL PLANT		RO	RO	19/10/17	20/02/18	B	16/08/18	RO	OVERLOAD MODIFICATIONS, ADDITION OF EMC FILTER, MAIN MOTOR BRAKE MODULE CHANGED	RP0151718	
PROJECT DESCRIPTION		GEMINI ROLL PLANT		RO	RO	27/03/19	27/03/19	D	RO	RO	MINOR UPDATES	RP0131819	
GEMINI		GEMINI		INSTALLATION		PANEL		ELECTRICAL SPECIFICATIONS:		TECHNICALLY APPROVED BY:		PAGE	
GEMINI		GEMINI		GEMINI		GEMINI		415VAC 3PH+N+E 50HZ		ANGELA THOMAS		388225-10014 1.4 OF 17	
GEMINI		GEMINI		GEMINI		GEMINI		GEMINI		GEMINI		GEMINI	



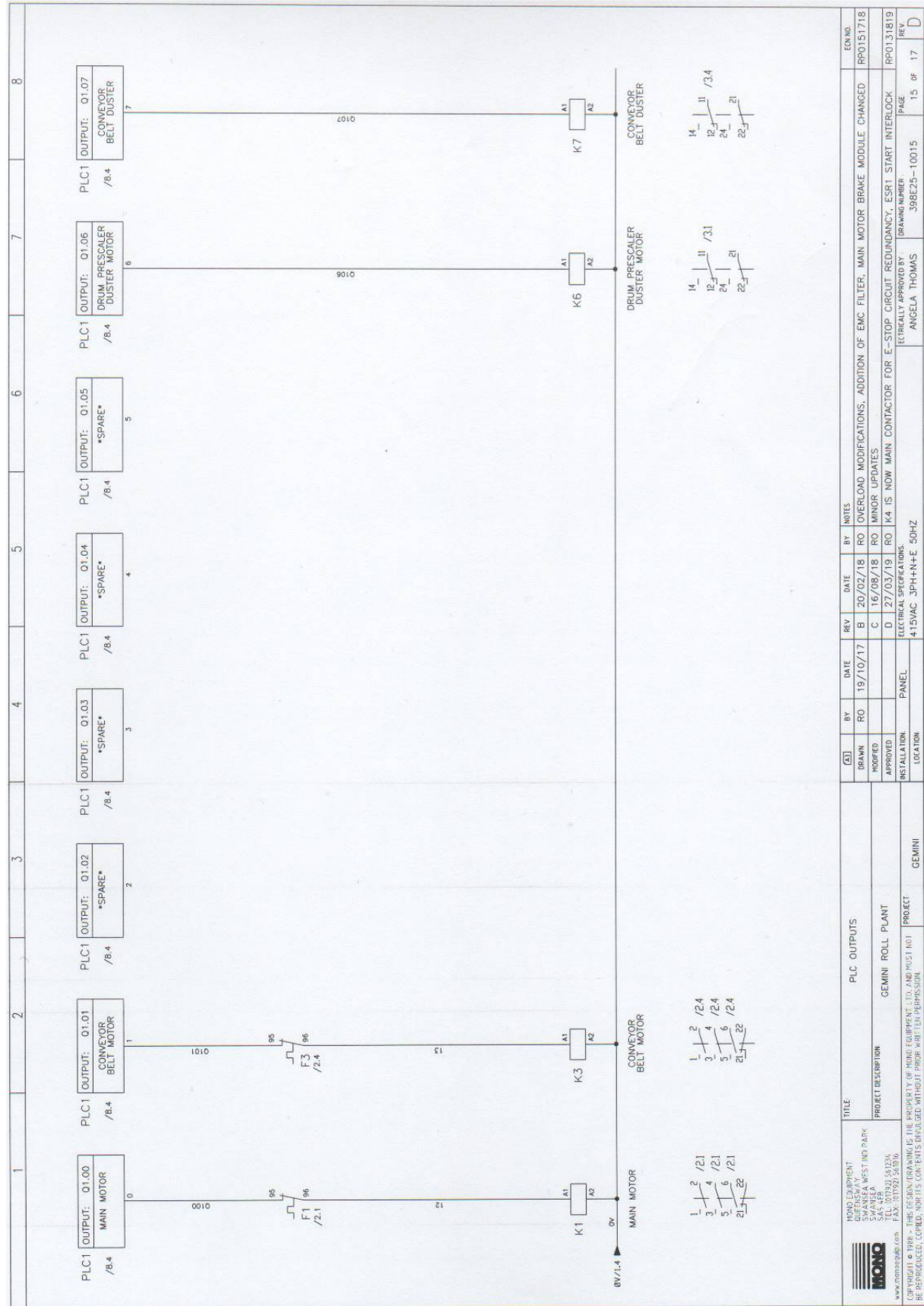

TITLE		PLC OUTPUTS		NOTES	
MONO EQUIPMENT QUEENSWAY WEST IND PARK SWANSEA SAS HER 301 6410X SAS HER 301 6410X FAX: 01792 58306 www.monogroup.com		GEMINI ROLL PLANT		BY RO	DATE 19/10/17
PROJECT DESCRIPTION GEMINI ROLL PLANT		GEMINI		REV B	DATE 20/02/18
PROJECT GEMINI		GEMINI		REV C	DATE 16/08/18
INSTALLATION LOCATION		GEMINI		REV D	DATE 27/03/19
ELECTRICAL SPECIFICATIONS: 415VAC 3PH3W+E 50HZ		GEMINI		BY RO	DATE 16/08/18
TECHNICALLY APPROVED BY ANGELA THOMAS		GEMINI		RO	RO
DRAWING NUMBER: 38823-10015		GEMINI		RO	RO
PAGE 15 OF 17		GEMINI		RO	RO
REV D		GEMINI		RO	RO
EON NO. RP0151718		GEMINI		RO	RO
EON NO. RP0131819		GEMINI		RO	RO



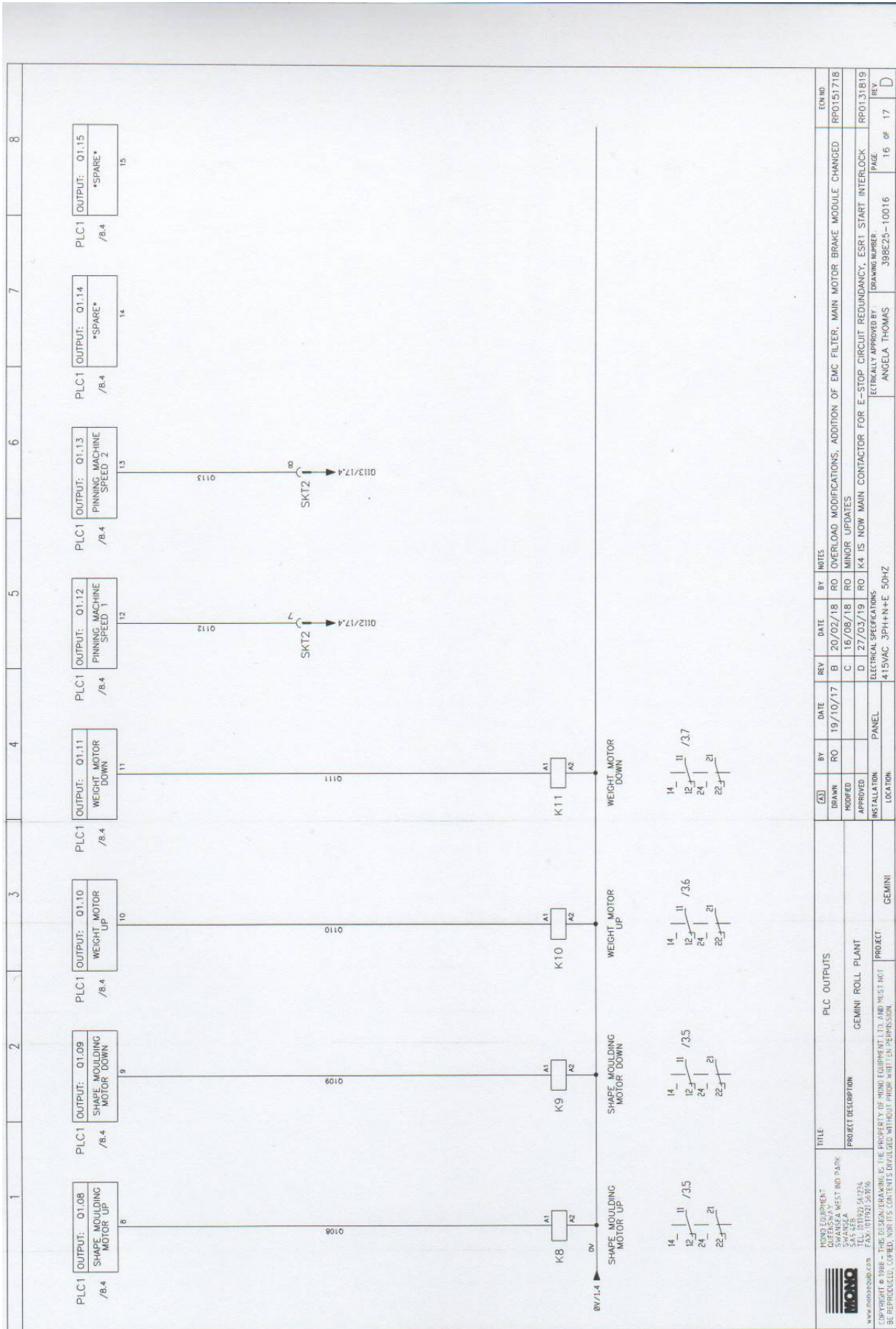

TITLE		PLC OUTPUTS		REV		DATE		BY		NOTES		EON NO	
MONO EQUIPMENT		GEMINI ROLL PLANT		(3)	RO	19/10/17	20/02/18	RO	RO	OVERLOAD MODIFICATIONS, ADDITION OF EMC FILTER, MAIN MOTOR BRAKE MODULE CHANGED	RP0151718		
QUEENSLAND WEST IND P&M		GEMINI ROLL PLANT		DRAWN	RO	16/08/18	16/08/18	RO	RO	MINOR UPDATES	RP0131819		
SWANSEA		GEMINI ROLL PLANT		APPROVED				RO	RO	K4 IS NOW MAIN CONTACTOR FOR E-STOP CIRCUIT REDUNDANCY, ESRT START INTERLOCK	REV		
SAS WEB 031 54724		GEMINI ROLL PLANT		INSTALLATION	PANEL			RO	RO	ELECTRICAL SPECIFICATIONS	PAGE		
www.monosquip.com		GEMINI ROLL PLANT		LOCATION				RO	RO	415VAC 3PH+1N+E 50HZ	16 of 17		
COPYRIGHT © 1988 - THE DESIGN DRAWING IS THE PROPERTY OF MONO EQUIPMENT LTD. AND MUST NOT BE REPRODUCED, COPIED, NOR ITS CONTENTS DISCLOSED WITHOUT PRIOR WRITTEN PERMISSION.		GEMINI ROLL PLANT						RO	RO	TECHNICALLY APPROVED BY: ANGELA THOMAS	D		

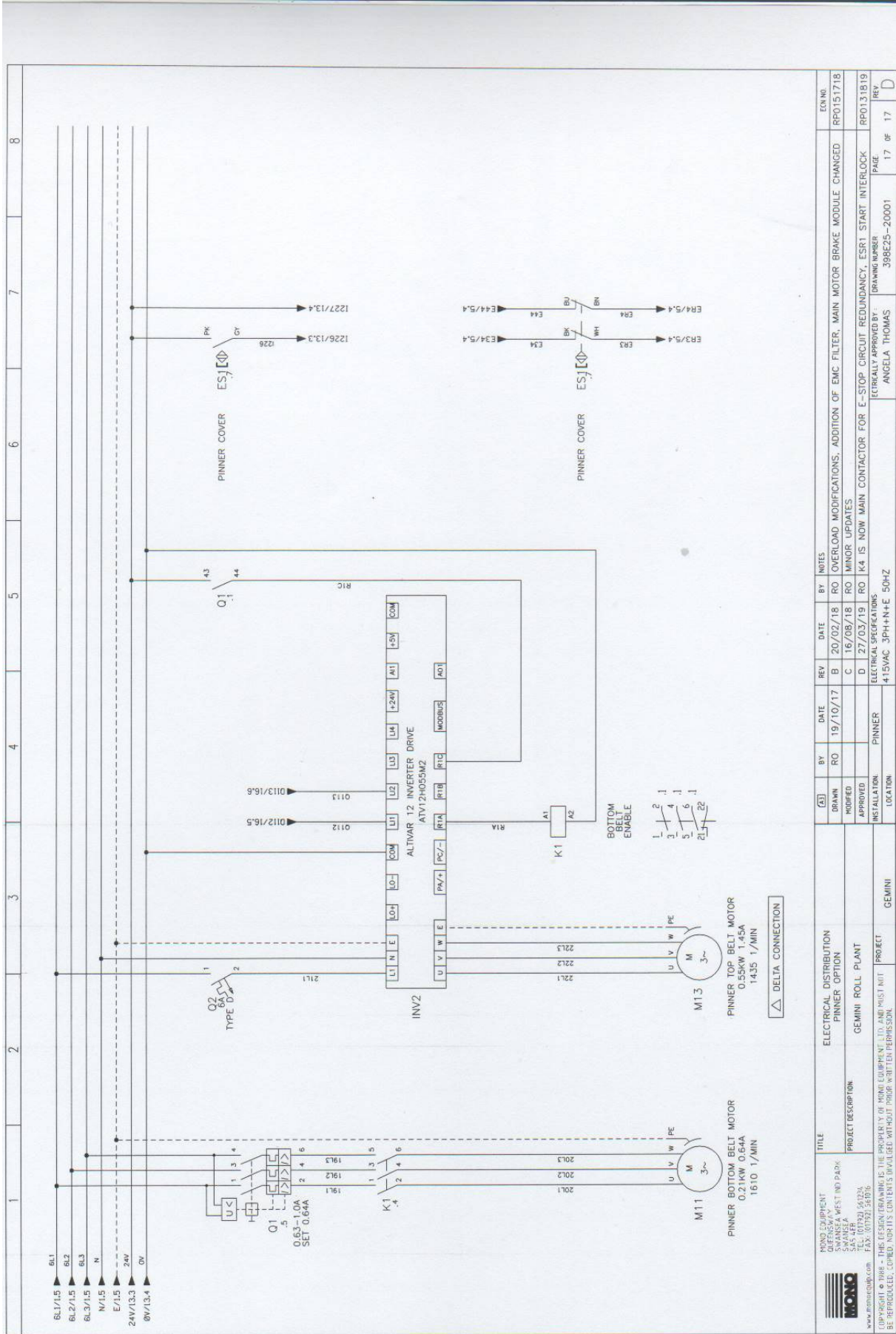

NO.	DATE	REV	BY	DATE	REV	BY	NOTES	ENGINO
1	19/10/17	B	RO	20/02/18	B	RO	LOWERLOAD MODIFICATIONS, ADDITION OF EMC FILTER, MAIN MOTOR BRAKE MODULE CHANGED	RP0151718
2	16/08/18	C	RO	16/08/18	C	RO	MINOR UPDATES	RP0151718
3	27/03/19	D	RO	27/03/19	D	RO	K4 IS NOW MAIN CONTACTOR FOR E-STOP CIRCUIT REDUNDANCY, ESR1 START INTERLOCK	RP0131819
ELECTRICALLY APPROVED BY:								REV
DRAWING NUMBER								17
LOCATION								OF
GEMINI								17
PROJECT								17
PRODUCT								17
ELECTRICAL SPECIFICATIONS								17
PINNER								17
415VAC 3PH+N+E 50HZ								17
398E25-20001								17
ANGELA THOMAS								17
PAGE								17
REV								17
D								17





# 15. ALARM MESSAGES: ---

<b>HMI ALARM MESSAGE</b>	<b>DESCRIPTION</b>	<b>CORRECTIVE ACTION</b>
<b>BACK COVER OPEN</b>	Back cover magnetic safety switch open	Close back cover
<b>BACK TOP LID OPEN</b>	Back top lid magnetic safety switch open	Close back top lid
<b>BELT START SENSOR TIME-OUT</b>	Belt start sensor not activated within time period	Check: Belt start sensor is adjusted correctly to pick up striker Belt start sensor is operating correctly
<b>BOTH SHAPE MOULDING LIMITS ACTIVE</b>	Shape moulding up and down sensors are activated	Check: Sensors are operating correctly Foreign object activating sensor
<b>BOTH WEIGHT LIMITS ACTIVE</b>	Weight up and down sensors are activated	Check: Sensors are operating correctly Foreign object activating sensor
<b>COMMUNICATIONS TIMEOUT</b>	HMI cannot communicate with the PLC	Check: Communications cable is plugged in correctly at both ends The communications cable is not damaged The PLC is in RUN mode
<b>CONTROL PANEL SIDE COVER 1 OPEN</b>	Control panel side 1 cover magnetic safety switch open	Close Control panel side 1 cover
<b>CONTROL PANEL SIDE COVER 2 OPEN</b>	Control panel side 2 cover magnetic safety switch open	Close Control panel side 2 cover
<b>CONVEYOR BELT MOTOR OVERLOAD</b>	Conveyor belt motor overload tripped	Check for mechanical obstructions Check cable connections / cable damage Reset overload
<b>DOUGH OUTFEED SECURITY SWITCH ACTIVATED</b>	Dough outfeed safety fork switch open	Close dough outfeed safety fork switch
<b>EMERGENCY STOP BUTTON ACTIVATED</b>	Emergency stop push button pressed	Release emergency stop push button
<b>FRONT COVER OPEN</b>	Front cover magnetic safety switch open	Close front cover
<b>HOPPER LID OPEN</b>	Hopper lid magnetic safety switch open	Close hopper lid
<b>HOPPER SAFETY RELAY ACTIVATED</b>	Hopper safety circuit not enabled	Check: Hopper lid switch magnetic safety switch Prescaler duster lid 1 magnetic safety switch Prescaler duster lid 2 magnetic safety switch

<b>INVERTER DRIVE AXIS ERROR [ID=?]</b>	Shape moulding motor inverter drive fault detected	Power cycle machine to clear fault If fault persists, call service stating fault ID
<b>INVERTER DRIVE COMMS ERROR</b>	Shape Moulding motor inverter drive cannot communicate with the PLC	Check: Communications cable is plugged in correctly at both ends The communications cable is not damaged The PLC is in RUN mode
<b>INVERTER DRIVE CONTROL ERROR</b>	Shape moulding motor inverter drive control fault detected	Power cycle machine to clear fault
<b>INVERTER DRIVE ERROR [ID=?]</b>	Shape moulding motor inverter drive error detected	Power cycle machine to clear fault If error persists, call service stating error ID
<b>MAIN MOTOR OVERLOAD</b>	Main motor overload tripped	Check for mechanical obstructions Check cable connections / cable damage Reset overload
<b>MAIN SAFETY RELAY 1 ACTIVATED</b>	Main safety circuit 1 not enabled	Check: Emergency stop push button Front cover magnetic safety switch Back cover magnetic safety switch Back top lid magnetic safety switch Control panel side cover 1 magnetic safety switch
<b>MAIN SAFETY RELAY 2 ACTIVATED</b>	Main safety circuit 2 not enabled	Check: Control panel side cover 2 magnetic safety switch Side cover 1 magnetic safety switch Side cover 2 magnetic safety switch Dough outfeed safety fork switch Pinning machine lid open
<b>PHASE SEQUENCE FAULT</b>	Mains supply phase out of sequence	Swap phase in mains plug
<b>PINNING MACHINE NOT CONNECTED</b>	Pinning machine plug not connected	Connect pinning machine OR Fit pinner link plug
<b>PINNING MACHINE TOP LID OPEN</b>	Pinning machine lid magnetic safety switch open	Close pinning machine lid

<b>PISTON DOUGH FEEDING SENSOR TIME-OUT</b>	Piston dough feeding sensor not activated within time period	Check: Piston dough feeding sensor is adjusted correctly to pick up Striker. Piston dough feeding sensor is operating correctly
<b>PRESCALER DUSTER LID 1 OPEN</b>	Prescaler duster lid 1 magnetic safety switch open	Close prescaler duster lid 1
<b>PRESCALER DUSTER LID 2 OPEN</b>	Prescaler duster lid 2 magnetic safety switch open	Close prescaler duster lid 2
<b>PRESCALER STAR SENSOR TIME-OUT</b>	Prescaler star sensor not activated within time period	Check: Prescaler star sensor is adjusted correctly to pick up striker Prescaler star sensor is operating correctly
<b>RECIPE ERROR (G?/R?/O?/S?/E?)</b>	Recipe load/save operation error detected	Call service stating error details
<b>SAVE ALARM LOG - USB MISSING ERROR</b>	USB memory stick not present/not operational when trying to save alarm log to USB	Confirm USB memory stick is inserted into USB port Use another USB memory stick
<b>SAVE ALARM LOG ERROR (C?/S?/E?/F?)</b>	Error detected when trying to save alarm log to USB	Call service stating error details
<b>SHAPE ENCODER TIME-OUT</b>	Shape moulding encoder count not changed within time period	Check: Shape moulding motor is operational Shape moulding encoder is coupled to drive shaft Shape moulding encoder connections are correct Shape moulding encoder is operating correctly
<b>SHAPE MOULDING DOWN TIME-OUT</b>	Shape moulding down sensor not activated within time period	Check: Shape moulding down sensor is adjusted correctly to pick up striker Shape moulding motor is operational Shape moulding down sensor is operating correctly
<b>SHAPE MOULDING DOWN WRONG SENSOR</b>	Shape moulding up sensor activated when motor commanded in down direction	Check: Shape Moulding motor is operational Shape moulding motor direction is correct Foreign object activating sensor

<b>SHAPE MOULDING UP TIME-OUT</b>	Shape moulding up sensor not activated within time period	<p>Check:</p> <p>Shape moulding up sensor is adjusted correctly to pick up striker</p> <p>Shape moulding motor is operational</p> <p>Shape moulding up sensor is operating correctly</p>
<b>SHAPE MOULDING UP WRONG SENSOR</b>	Shape moulding down sensor activated when motor commanded in up direction	<p>Check:</p> <p>Shape Moulding motor is operational</p> <p>Shape moulding motor direction is correct</p> <p>Foreign object activating sensor</p>
<b>SIDE COVER 1 OPEN</b>	Side 1 cover magnetic safety switch open	Close side 1 cover
<b>SIDE COVER 2 OPEN</b>	Side 2 cover magnetic safety switch open	Close side 2 cover
<b>STAR AND BELT MOTOR OVERLOAD</b>	Star and belt motor overload tripped	<p>Check for mechanical obstructions</p> <p>Check cable connections / cable damage</p> <p>Reset overload</p>
<b>START POSITION SENSOR TIME-OUT</b>	Start position sensor not activated within time period	<p>Check:</p> <p>Start position sensor is adjusted correctly to pick up striker</p> <p>Main motor is operational</p>
<b>SYSTEM START-UP</b>	Information message for alarm log	N/A
<b>WEIGHT DOWN TIME-OUT</b>	Weight down sensor not activated within time period	<p>Check:</p> <p>Weight down sensor is adjusted correctly to pick up striker</p> <p>Weight motor is operational</p> <p>Weight down sensor is operating correctly</p>
<b>WEIGHT DOWN WRONG SENSOR</b>	Weight up sensor activated when motor commanded in down direction	<p>Check:</p> <p>Weight motor is operational</p> <p>Weight motor direction is correct</p> <p>Foreign object activating sensor</p>
<b>WEIGHT ENCODER TIME-OUT</b>	Weight encoder count not changed within time period	<p>Check:</p> <p>Weight motor is operational</p> <p>Weight encoder is coupled to drive shaft</p> <p>Weight encoder connections are correct</p> <p>Weight encoder is operating correctly</p>

**WEIGHT UP TIME-OUT**

Weight up sensor not activated within time period

Check:

Weight up sensor is adjusted correctly to pick up striker

Weight motor is operational

Weight up sensor is operating correctly

**WEIGHT UP WRONG SENSOR**

Weight down sensor activated when motor commanded in up direction

Check:

Weight motor is operational

Weight motor direction is correct

Foreign object activating sensor

## 16. Environmental Disposal: ---

- Care should be taken when disposing of the machine when it comes to the end of its working life
- All parts should be disposed of in the most appropriate, environmentally-friendly manner possible, either by recycling or other means of disposal which complies with local regulations
- Only dispose of the machine safely and legally
- The Environmental Protection Act 1990 applies in the UK

# 17. Service & Spares – ---

## Contact Details:

If a fault arises with the Two-Pocket Roll Plant or the Roll Forming Unit (if fitted), please do not hesitate to contact MONO's Customer Service Department, quoting the machine's **Serial Number** which can be found on the Manufacturer's Plate and on the front cover of this document.



**MONO Equipment**  
Queensway  
Swansea West Industrial Estate  
Swansea.  
SA5 4EB  
United Kingdom

### Contact:

[spares@monoequip.com](mailto:spares@monoequip.com)  
+44 (0)1792 564039

[techsupport@monoequip.com](mailto:techsupport@monoequip.com)  
+44 (0)1792 564 041

[service@monoequip.com](mailto:service@monoequip.com)  
+44 (0)1792 564 048

Switchboard: +44 (0)1792 561 234