



www.monoequip.com

Enter **Serial Nos.** here

DECK 1

DECK 2

DECK 3

DECK 4

DECK 5

FAN (IF FITTED)

In the event of an enquiry please quote these serial numbers.

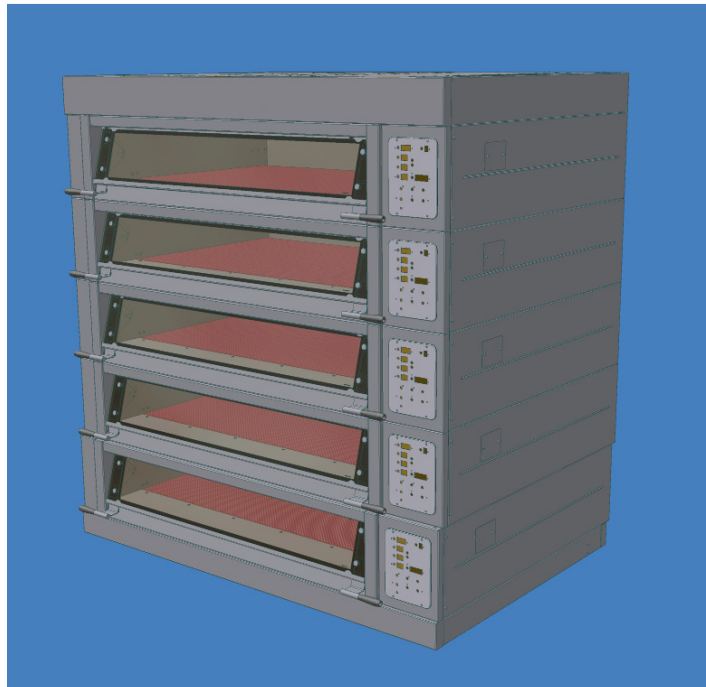

OPERATION AND MAINTENANCE MANUAL

MODULAR DECK OVEN (classic control)

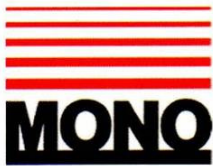

DECLARATION OF CONFORMITY

We hereby declare that this machine complies with the essential health and safety requirements of :-

- The Machinery Directive 2006 / 42 / EC
- The Low voltage Directive 2014 / 35/ EC
- The requirements of the Electromagnetic Compatibility Directive 2004 / 108EC, 91 / 263 / EEC, 92 / 31 / EEC
Incorporating standards
EN55014-1:2006+A1:2009+A2:2011
EN55014-2:1997+A1:2001+A2:2008
- The General Safety of Machinery and food processing Standards applicable
- Materials and Articles intended to come into contact with food Regulation (EC) No. 1935 / 2004

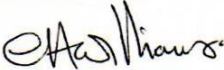
Signed	
G.A.Williams – Quality Manager	

Date	
-------------	--

Machine FG Code.		Machine Serial No.	
-----------------------------	--	-------------------------------	--

A technical construction file for this machine is retained at the following address:

MONO EQUIPMENT
Queensway,
Swansea West Industrial Park,
Swansea
SA5 4EB
UK

MONO EQUIPMENT is a business name of **AFE GROUP Ltd**
Registered in England No.3872673 VAT registration No.923428136

Registered office: Unit 9, Bryggen Road,
North Lynn Industrial Estate,
Kings Lynn,
Norfolk,
PE30 2HZ

SAFETY SYMBOLS

The following safety symbols are used throughout this product documentation. Before using your new equipment, read the instruction manual carefully and pay special attention to information marked with the following symbols.



WARNING

Indicates a hazardous situation which, if not avoided, will result in death or serious injury.



WARNING

Indicates a hazardous situation which, if not avoided, will result in electric shock.



CAUTION

Indicates a hazardous situation which, if not avoided, will result in minor or moderate injury.

ELECTRICAL SAFETY AND ADVICE REGARDING SUPPLEMENTARY ELECTRICAL PROTECTION:

Commercial bakeries, kitchens and foodservice areas are environments where electrical appliances may be located close to liquids or operate in and around damp conditions or where restricted movement for installation and service is evident.

The installation and periodic inspection of the appliance should only be undertaken by a qualified, skilled and competent electrician, and connected to the correct supply suitable for the load as stipulated by the appliance data label.

The electrical installation and connections should meet the necessary requirements of the local electrical wiring regulations and any electrical safety guidelines.

We Recommend:

- Supplementary electrical protection with the use of a residual current device (RCD)
- Fixed wiring appliances incorporate a locally situated switch disconnecter to connect to, which is easily accessible for switching off and safe isolation purposes. The switch disconnecter must meet the specification requirements of IEC 60947.



The supply to this machine must be protected by a **30mA RCD**



Failure to adhere to the cleaning and maintenance instructions detailed in this booklet could affect the warranty of this machine.

The oven should only be used for baking bread, pastries and cakes (for other products please contact your oven supplier)

ERROR MESSAGES

IF THESE NUMBERS APPEAR IN THE TEMPERATURE WINDOW PLEASE CHECK THE FOLLOWING:

888 – Indicates that the control board area is above 70 degrees.
*Check that the cooling slots/fan at the top of the control panel are not blocked by any bakery items (oven glove etc).
If not, call an engineer to check the problem*

999 – Indicates a problem with the thermocouple.
Call an engineer to check for connection problems or faulty thermocouple.

CONTENTS

Section - 1.0	Introduction
Section - 2.0	Overall Dimensions
Section - 3.0	Specifications
Section - 4.0	Safety
Section - 5.0	Installation
Section - 6.0	Isolation
Section - 7.0	Cleaning
Section - 8.0	Operating Conditions
Section - 9.0	Principles Of Operation (and baking advice)
Section - 10.0	Operating Instructions
Section - 11.0	Troubleshooting
Section - 12.0	Service Information Replacing light bulbs
Section - 13.0	Spares Information

THIS SECTION IS FOR ENGINEERS ONLY AND THE CUSTOMER SHOULD NOT ATTEMPT TO MAKE ALTERATIONS.

Section - 14.0	Electrical Information
----------------	------------------------

1.0 INTRODUCTION

The electric modular Deck Oven is an easy to use practical, good-looking oven, giving an excellent heat recovery rate and an even bake across a wide range of bread and confectionery products.

- **Good looking and totally reliable**

Conceived with the no nonsense requirements of both the independent and in-store baker in mind, and designed to visually please as well as give reliable service for many years. This oven will more than satisfy the most discerning customer.

- **Top quality specification**

The external and internal contact surfaces are stainless steel.

Each modular deck is fitted with durable reinforced deck tiles, and an increase in high-grade insulation and high temperature ceramic sealant, makes the oven more efficient.

The oven comes with a patented integral steaming system, which reduces energy consumption and the overall size of the oven (no drain required). The system produces real steam with the advantages of spray steam. Pre-steam is also available to reduce the affects of long loading times.

No drainage is required.

Supplied with an LED screen. All programmable parameters have separate indicators for easy programming and extra bake time, if required.

An energy saving 7-day timer is also standard.

The simplified electrical circuits aid reliability with overheat protection (on controllers and oven) to ensure long life of controllers, all housed in splash-proof electrical enclosures.

The lights are low voltage, sealed from the chamber and easily accessed from outside the oven.

An “i” button can be used to upgrade firmware without the need of dismantling the panels.

Fitted with a choice of hinged easy to clean double glazed doors (using low energy-loss reflective glass for high visibility) or metal doors, means low energy consumption and the high kW rating gives good recovery.

(0-100% heating available both top and bottom)

2.0 OVERALL DIMENSIONS

ALL DIMENSIONS ARE APPROXIMATE

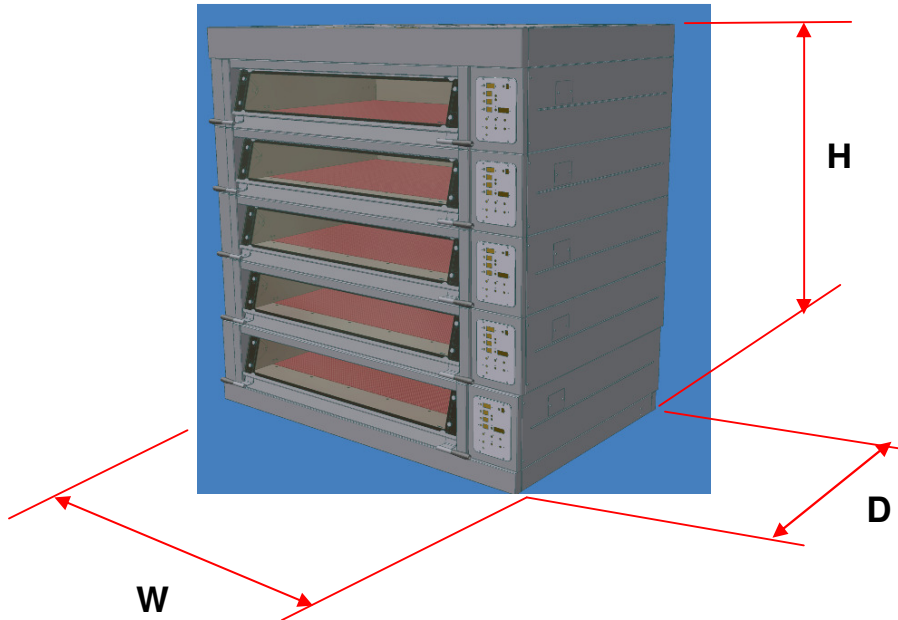

5 DECK oven **H** = 2135mm

4 DECK oven **H** = 2020mm

3 DECK oven **H** = 2020mm

Ovens available with 1,2,3, 4, and 5 modules

812mm deep modules **D** = 1300mm

3 Tray wide oven **W** = 1890mm

2 Tray wide oven **W** = 1416mm

1 Tray wide oven **W** = 940mm

3.0 SPECIFICATIONS

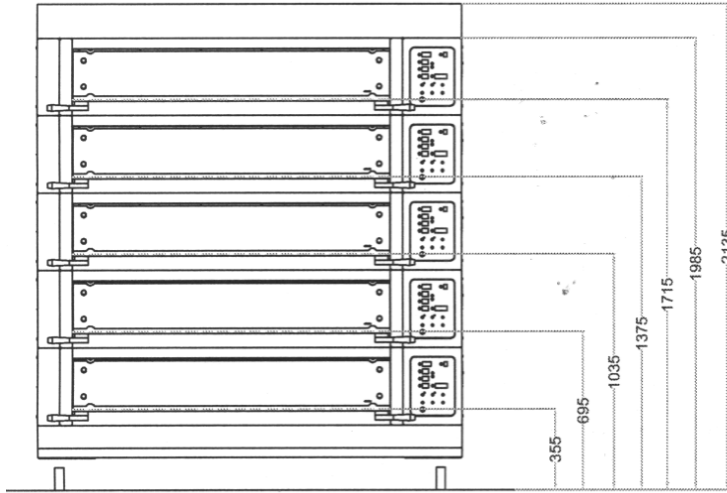

**5 DECK OVEN
DECK PLATE HEIGHTS**

**4 DECK OVEN
DECK PLATE HEIGHTS**

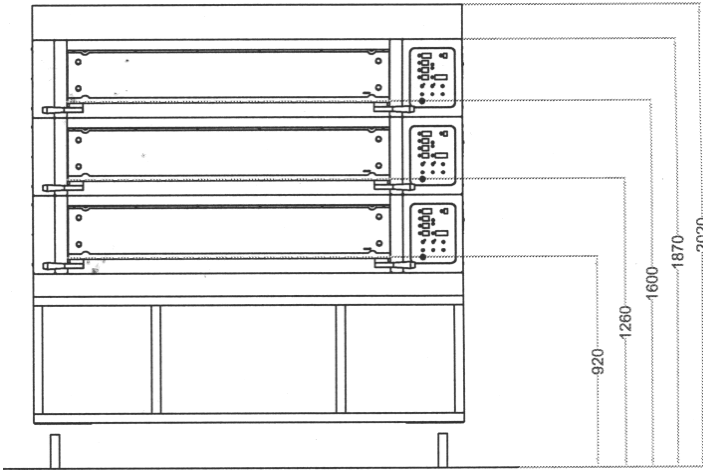
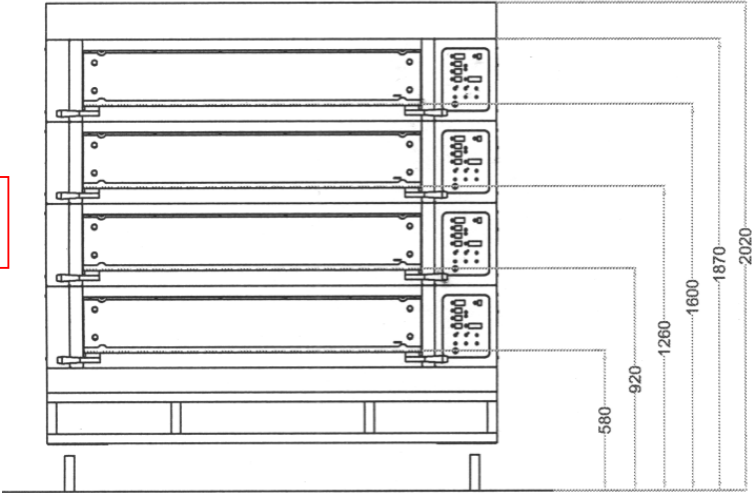

**3 DECK OVEN
DECK PLATE HEIGHTS**

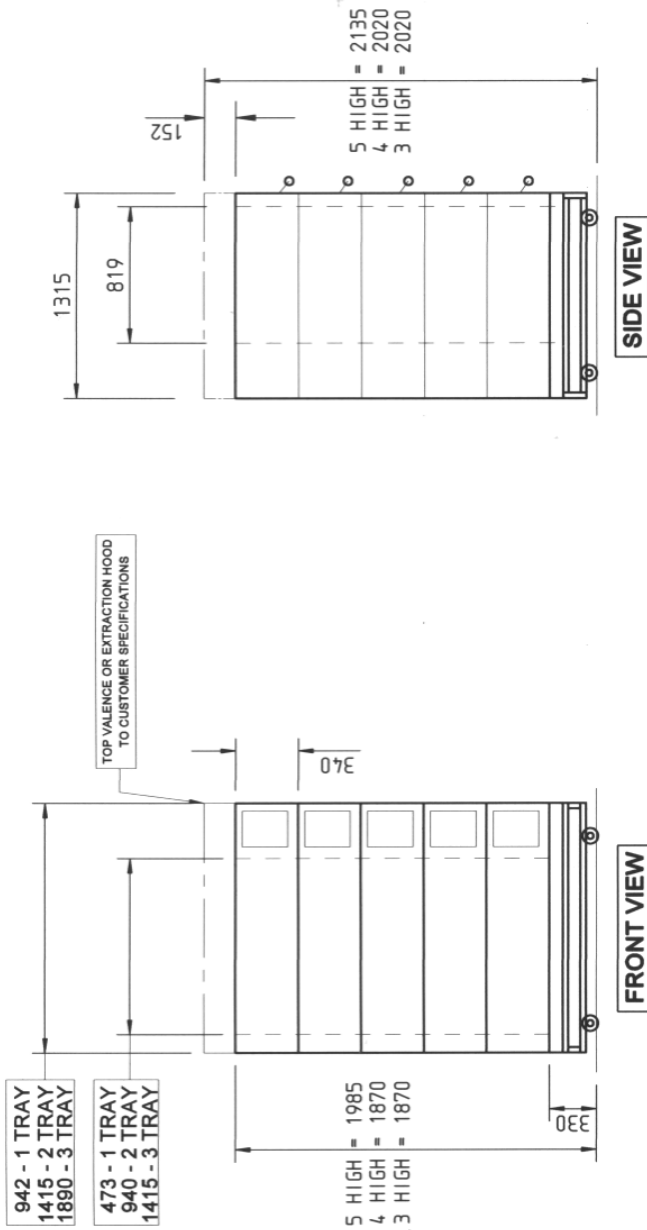

DIMENSIONS IN MILLIMETRES
FOR WEIGHTS SEE SPECIFICATION NOTES

NOMINAL TRAY WIDTH	EXTERNAL AREA	INTERNAL SURFACE AREA	No. OF TRAYS (per deck)
3 tray	2.48Mtr ²	1.16Mtr ²	609 x 813 609 x 406 457 x 762 457 x 660
2 tray	1.85Mtr ²	0.77Mtr ²	2 3 3 3
1 tray	1.24Mtr ²	0.39Mtr ²	1 2 2 2 1 1 1 1

MONO MODULAR DECK OVEN

ELECTRICAL LOADINGS:



The supply to this machine must be protected by a **30mA RCD**

Mk 2 Modular Uk/European Deck Oven Electrical Loadings

- 3 Tray Wide , 400V 3 phase N plus earth 50hz (230 V elements) ----- 9Kw , 14 amps per phase per deck
- 2 Tray Wide , 400V 3 phase N plus earth 50hz (230 V elements) ----- 6 Kw , 9 amps per phase per deck
- 1 Tray Wide, 400V 3 phase N plus earth 50hz (230 V elements) ----- 3 Kw , 5 amps per phase per deck

<u>Number of decks</u>	<u>Number of trays wide</u>	<u>Total current</u>	
5	3	70 amps/phase	Fuse at 80 amps
4	3	56 amps/phase	Fuse at 63 amps
3	3	42 amps/phase	Fuse at 50 amps
2	3	28 amps/phase	Fuse at 32 amps
1	3	14 amps/phase	Fuse at 20 amps

<u>Number of decks</u>	<u>Number of trays wide</u>	<u>Total current</u>	
5	2	45 amps/phase	Fuse at 50 amps/phase
4	2	36 amps/phase	Fuse at 40 amps/phase
3	2	27 amps/phase	Fuse at 32 amps/phase
2	2	18 amps/phase	Fuse at 20 amps
1	2	9 amps/phase	Fuse at 10 amps/phase
5	1	25 amps/phase	Fuse at 32 amps/phase
4	1	20 amps/phase	Fuse at 25 amps/phase
3	1	15 amps/phase	Fuse at 16 amps/phase
2	1	10 amps/phase	Fuse at 16amps/phase
1	1	5 amps/phase	Fuse at 6 amps/phase

Single phase

- 3 Tray Wide, 230V 1 phase N plus earth 50hz (230 V elements) ---- 9Kw, 40 amps per deck
- 2 Tray Wide, 230V 1 phase N plus earth 50hz (230 V elements) ---- 6 Kw, 27 amp per deck
- 1 Tray Wide, 230V 1 phase N plus earth 50hz (230 V elements) ---- 3 Kw, 13 amp per deck

NOISE LEVEL: Less than 80 Db

WEIGHT:

(ALL WEIGHTS ARE APPROXIMATE)

Total oven weight	– 2 tray wide, 3 deck	= 1569lbs	(711kg)
(Including base frame)	– 3 tray wide, 3 deck	= 2345lbs	(1064kg)
	– 1 tray wide, 3 deck	= TBA	

Weight per oven chamber module	– 2 tray wide	= 421lbs	(191.5kg)
	– 3 tray wide	= 575lbs	(261kg)
	– 1 tray wide	= TBA	

Weight per oven canopy module	– 2 tray wide	= 31lbs	(14kg)
	– 3 tray wide	= 38lbs	(17kg)
	– 1 tray wide	= TBA	

Weight per fan module	– 2 tray wide	= 62lbs	(28kg)
	– 3 tray wide	= 62lbs	(28kg)
	– 1 tray wide	= TBA	

Weight of product (max) per deck	– 2 tray wide	= 86lbs	(39kg)
	– 3 tray wide	= 131lbs	(60kg)
	– 1 tray wide	= TBA	

4.0 SAFETY



All maintenance must be made with the oven disconnected from the power supply and then only by fully trained authorized persons.

- Check all cover panels, and any pipefittings are securely positioned.
- Check oven door handles are not damaged.



- **Do not operate a deck's steaming system with oven door open.**
- Always use oven gloves when loading or unloading the oven.
- When products are removed from the oven, ensure:
 - (a) Tins are knocked out and stored directly onto a tin storage trolley or rack (Do not leave hot tins on the floor or on tables).
 - (b) Trays are put into a rack and the rack is wheeled to a safe cooling area.

- Do not store items on top of the oven.
- Do not store items behind the oven.



- Beware of hot surfaces. Do not touch oven front or door with bare skin.
- All operatives must be fully trained
- People undergoing training must be under direct supervision
- The oven should only be used for baking bread, pastries and cakes (for other products please contact your oven supplier)
- No unauthorized modifications should be made to the oven.



- **Do not walk on the roof of the oven**

- **DISPOSAL**

Care should be taken when the oven comes to the end of its working life. All parts should be disposed of in the appropriate place, either recycling or other means as the law permits at the time.



NOTE: BAKERY STAFF MUST NOT UNDER ANY CIRCUMSTANCES REMOVE PANELS TO ACCESS ANY PART OF THE DECK OVEN.

Panels should only be removed by a Mono maintenance engineer (or other fully trained maintenance contractor) for repairs or maintenance, after isolating oven from power supply.

The Bakery Manager or the Bakery Supervisor must carry out the above daily safety checks

5.0 INSTALLATION

GENERAL

- A hard smooth level floor is recommended on which to position the oven and access for maintenance should be considered.
The oven is not designed to be "built in" so sufficient clearance must be left in front of the access panels (right hand side) to allow for servicing.
- If not chosen as an oven option, it is recommended that an extraction hood be placed above the oven to disperse excess steam and heat, which could have an adverse effect on the bakery ceiling and ambient temperature.



The supply to this machine must be protected by a **30mA RCD**

- A wall isolator **must** be available in order to completely isolate the oven.
THIS ISOLATOR MUST BE CLEARLY ACCESSIBLE TO THE OVEN OPERATOR

- A chain retainer should be fitted, that is shorter than the power cables, to protect them from strain if the oven is moved. (Fit to the wall or floor and the base, using hole provided in castor fixing corner plates).
- Installation must be made by a trained authorized engineer and all utilities must conform to all local regulations.
- **The oven must be "run in" as stated in the initial start up instructions.**

IMPORTANT OPERATION

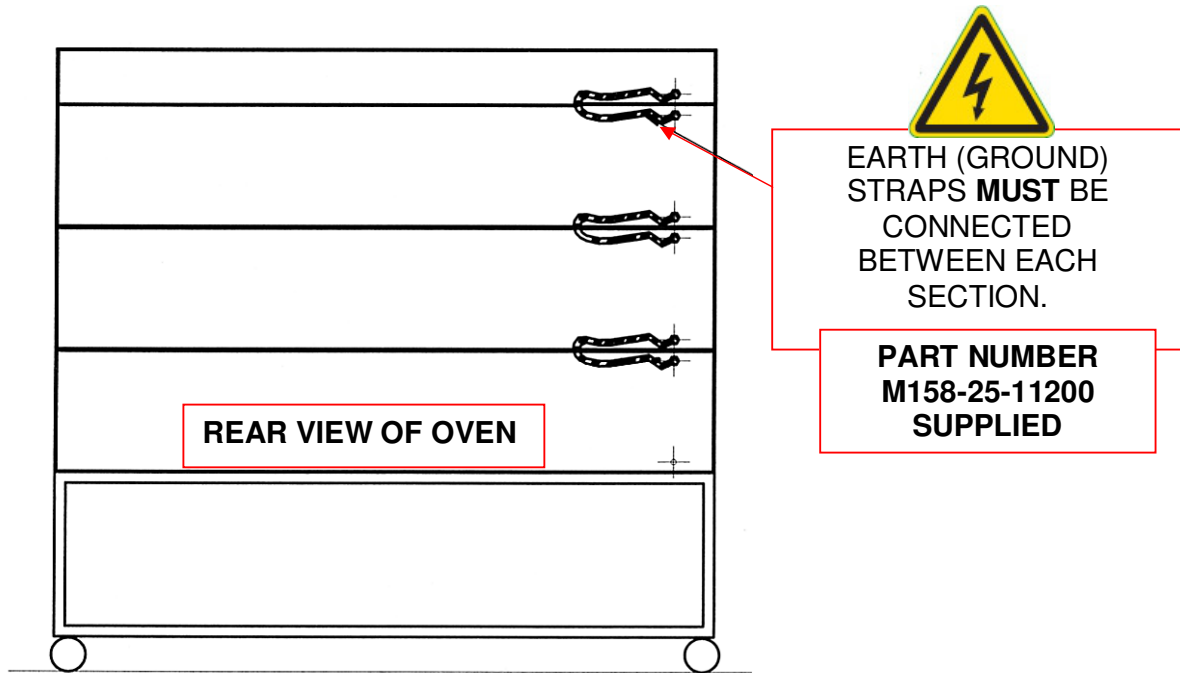

WATER SUPPLY REQUIREMENTS

The set up procedure on the next page must be followed to allow the steaming system to function correctly

- All ovens with steam require a ½” NPT hot or cold water supply at a pressure of 2 - 3 bar (29 – 44 psi). Located approximately 250mm from the right and 100mm from the top of the stand when facing the front of the oven.
- Only one water supply is required per oven. The connections should comply with local water regulations. A manifold supplies all decks from one connection point.
- For proper operation of the steam system it is recommended that the water supply follows the following specifications:

Hardness 2-4 grains per gallon

PH range 7.0 to 8.0

Chloride concentration 0 –30 ppm

Consult your water treatment company for proper water filtration system information.

- No drain is required for this oven.
- A non-return check-valve is supplied fitted to the water inlet manifold.

WATER SYSTEM SETUP PROCEDURE

It is imperative that the water delivery to the deck oven is checked for the steam system to operate correctly

1. Flush out the main feed pipe to be used, until water runs clear and free from debris.
2. Connect main feed to oven.
3. Connect flexible hoses to each deck.
4. Place a container under the test valve.
5. Slowly open test valve fully and with the water flowing check the regulator is set to 0.75 bar. If not adjust using the screw above the valve.
 - **Never use the oven above this setting**
6. When the pressure has stabilised shut the test valve.

REPEAT 4,5 AND 6 AT THE END OF INSTALLATION.

NOTE. DYNAMIC PRESSURE, NOT STATIC, IS BEING MEASURED.

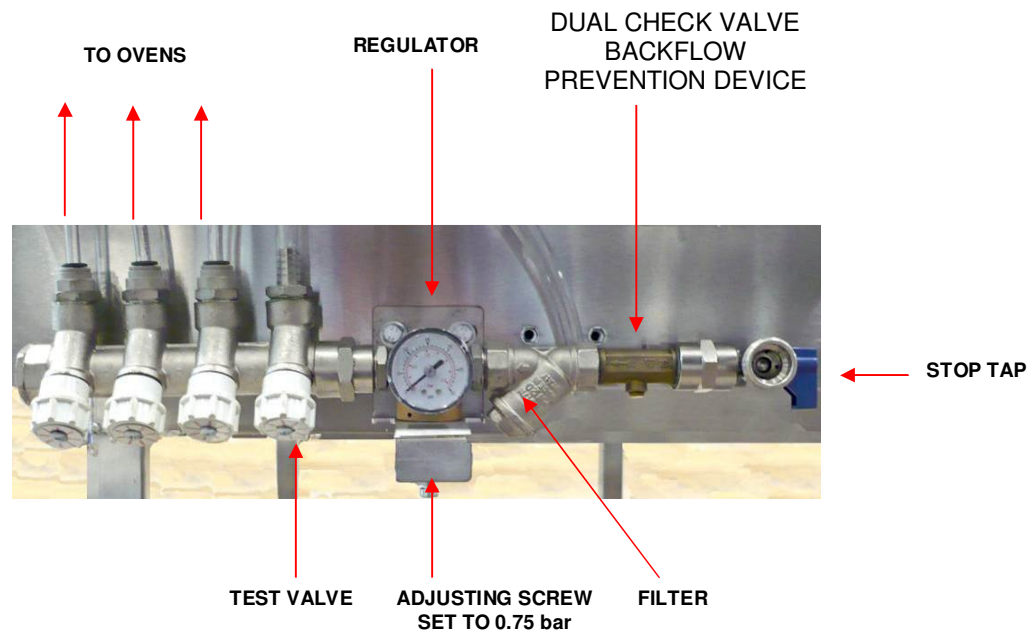

WATER REGULATOR SET UP
LOCATED ON REAR OF OVEN

Exhaust Connections (IF CANOPY FITTED)

- Ideally an exhaust duct should rise 2 metres above the bakery roof protected from wind and birds by a duct protector.
- It should be of a suitable material to take the high temperatures and humidity expected.
- It should be flexible and easily removable at the oven connection point. *This allows the oven to be moved for cleaning when required.*

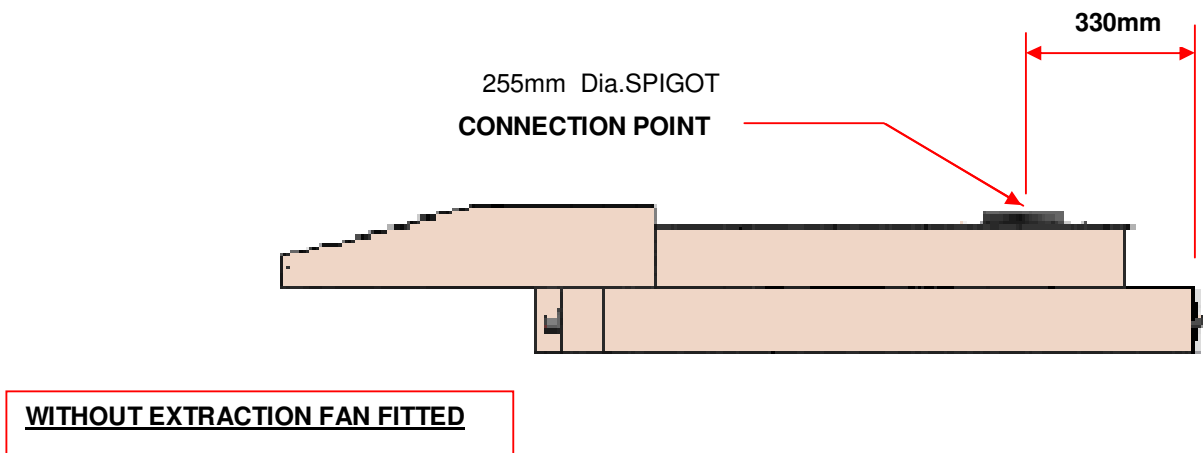
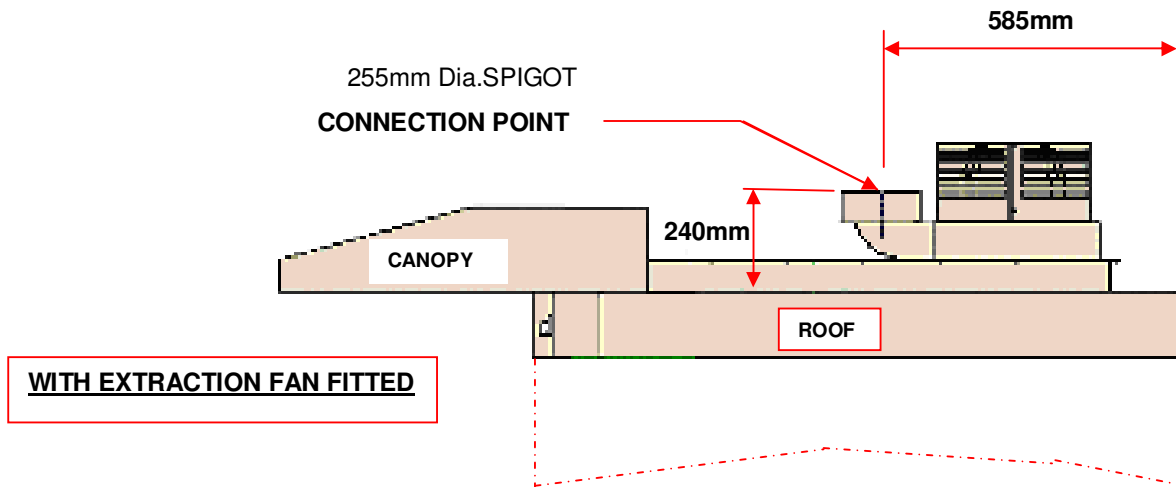

INITIAL START UP

THIS PROCEDURE MUST BE ADHERED TO FOR THE OVEN WARRANTY TO BE VALID.

In order for the oven to give good reliable service the deck tiles must be initially brought up to temperature as stated below.

After this running in period the oven can be used as required.

Tile seasoning sequence

1. To initialise the sequence press the top and bottom heat buttons together, keep depressed while powering oven on. After the controller beeps and the software version is displayed release the buttons.
2. The controller now displays the target temperature in the bake temperature window and the seasoning routine time remaining is shown in the bake time window.
3. The target temperature display will increase in pre set increments over a 5 hours 45 minute period and the countdown timer will show time remaining.
4. At the end of the sequence the controller switches into standby mode and the oven can then be used normally.
5. During this process the damper will open on the hour and remain open for 30 minutes to vent the moisture from the oven chamber.

Note – to stop the tile seasoning sequence switch the oven off at the main electrical supply Isolator then switch back on, controller reverts to standby.

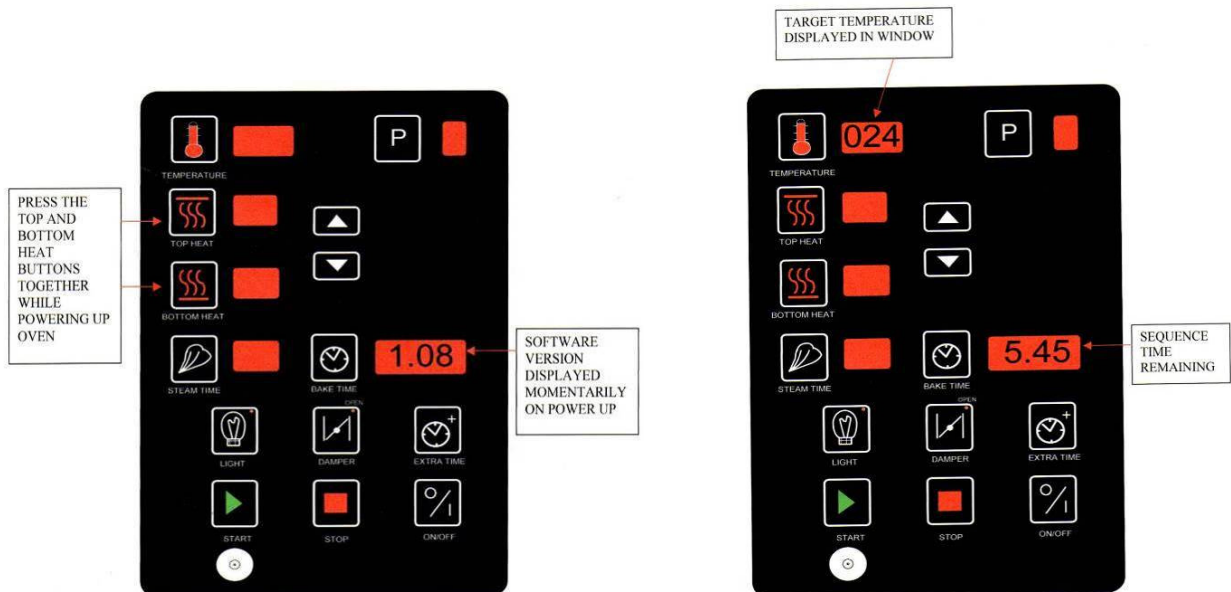

6.0 ISOLATION



WARNING

THE “POWER OFF” BUTTON ON THE FRONT OF THE OVEN DOES NOT ISOLATE THE POWER SUPPLY.



A WALL ISOLATOR MUST BE AVAILABLE IN ORDER TO COMPLETELY ISOLATE THE OVEN.

THIS ISOLATOR MUST BE CLEARLY ACCESSIBLE AND KNOWN TO THE OVEN OPERATOR

TO STOP THE OVEN IN AN EMERGENCY SWITCH OFF AT THE MAIN WALL ISOLATOR

7.0 CLEANING

DAILY CLEANING INSTRUCTIONS



ISOLATE OVEN FROM MAINS SUPPLY BEFORE CLEANING.

- After the oven has been allowed to cool, (this could take several hours), sweep any debris out.
Use a vacuum cleaner with metal attachments (able to take heat) if available.
- Brush down and wipe oven front, back and sides with a damp cloth.
- Spot clean with a damp cloth, which has been soaked in a solution of mild detergent, and hot water, paying particular attention to ensure excess water is not applied around the area of the electrical panels.

NOTE: TAKE CARE WATER DOES NOT ENTER CONTROL PANEL MOUNTING OR ROOF MOUNTED FAN.

WEEKLY CLEANING INSTRUCTIONS



ISOLATE OVEN FROM MAINS SUPPLY BEFORE CLEANING.

- Complete daily cleaning as above.
- Scrub oven wheels with a mild detergent and hot water using nylon cleaning brush (excess water will rust metal).
- Ensure the oven roof area is clear of debris and dust build up.
(DO NOT STAND ON THE OVEN ROOF)



8.0 OPERATING CONDITIONS

- It is recommended that a space of at least 6 feet be left in front of the oven for ease of operation and safety.
- Bakery utensils must not be used to operate the control panel buttons.

9.0 PRINCIPLE OF OPERATION

NOTE: REFER TO YOUR OWN COMPANY'S RECIPE MANUAL FOR OVEN TEMPERATURE SETTINGS.

PLEASE ALSO REFER TO THE BAKING ADVICE ON THE NEXT PAGE

Products are baked in an insulated heated chamber. The temperature is regulated by a thermocouple having an LED read-out on the front control panel. Baking heat is radiant with top and bottom heat being adjusted by means of separate controls. This enables heat to be "balanced" according to product requirement.

STEAM is provided from an integral steam unit, and is introduced into the chamber on demand. This is automatically controlled by the programmed parameters. **Once steamed the oven will not steam until the steam unit has recovered heat, typically 3-8 minutes depending on the amount of steam selected.**

All ovens are fitted with a **steam damper** that evacuates steam humidity into a vent at the side of the oven.

Baking Advice

For the best results from deck Ovens

Loading

1. **Do not place the products too close together.** *If the loaves are close to each other after oven spring (expansion), the loaves sides will be soft and may collapse on cooling.*
2. **Place the product evenly within the oven.** *Product bunched together will be paler than those widely spaced.*
3. **Product should not be placed too close to the edge of the tile.** *As it expands towards the front one side of the loaf may enter the cooler air by the door.*
4. **Door opening should be kept to a minimum** *because cold air enters the oven cooling the sidewalls and roof causing the finished product to be lighter locally at the front and wasting heat. If loading times are consistently long you can alter the front top heat to put more heat at the front.*
5. **If the loading takes a long time product can form a skin,** *which causes an imbalance and a less attractive finish. By using the pre-steam function before loading this can be minimised. This function turns the elements off and injects steam to increase the humidity.*
6. **If whilst baking, the bake is found to be consistently dark or light at the front** *the front top element can also be adjusted for local fluctuations in voltage.*

Bake settings

1. A good starting point for baking breads in Mono deck ovens is **225C (437F)**
Top heat 60-65 bottom heat 40.
2. For cookies etc the heat in the oven can be turned almost off, however it may still be necessary to place the trays with cookies etc onto upturned trays on the oven sole.
3. **Steam** should be kept to a minimum, for energy efficiency, depending on the product and finish. **Times between 9 and 12 seconds should be adequate.**
4. It is a good idea not to focus on the temperature recovery this can vary from oven to oven.

Is the product baked in the time and to the quality you require?

Below are some tips for modifying the bake so you get the product that you require.

- If your product is **light on top**.

Either decrease the bottom heat and extend bake time or increase the top heat.

- If the product **sides are pale** and the **top dark**.

When the products are spaced well apart drop the top heat and extend the bake.

- **If the bake time is too long.**

First increase the top heat to speed recovery.

If this does not give sufficient savings increase the bake temperature.

- **To thicken the crust**

Set the damper to open longer. Different ovens will require different lengths of time.

10.0 OPERATING INSTRUCTIONS

CLASSIC DECK OVEN CONTROLLER

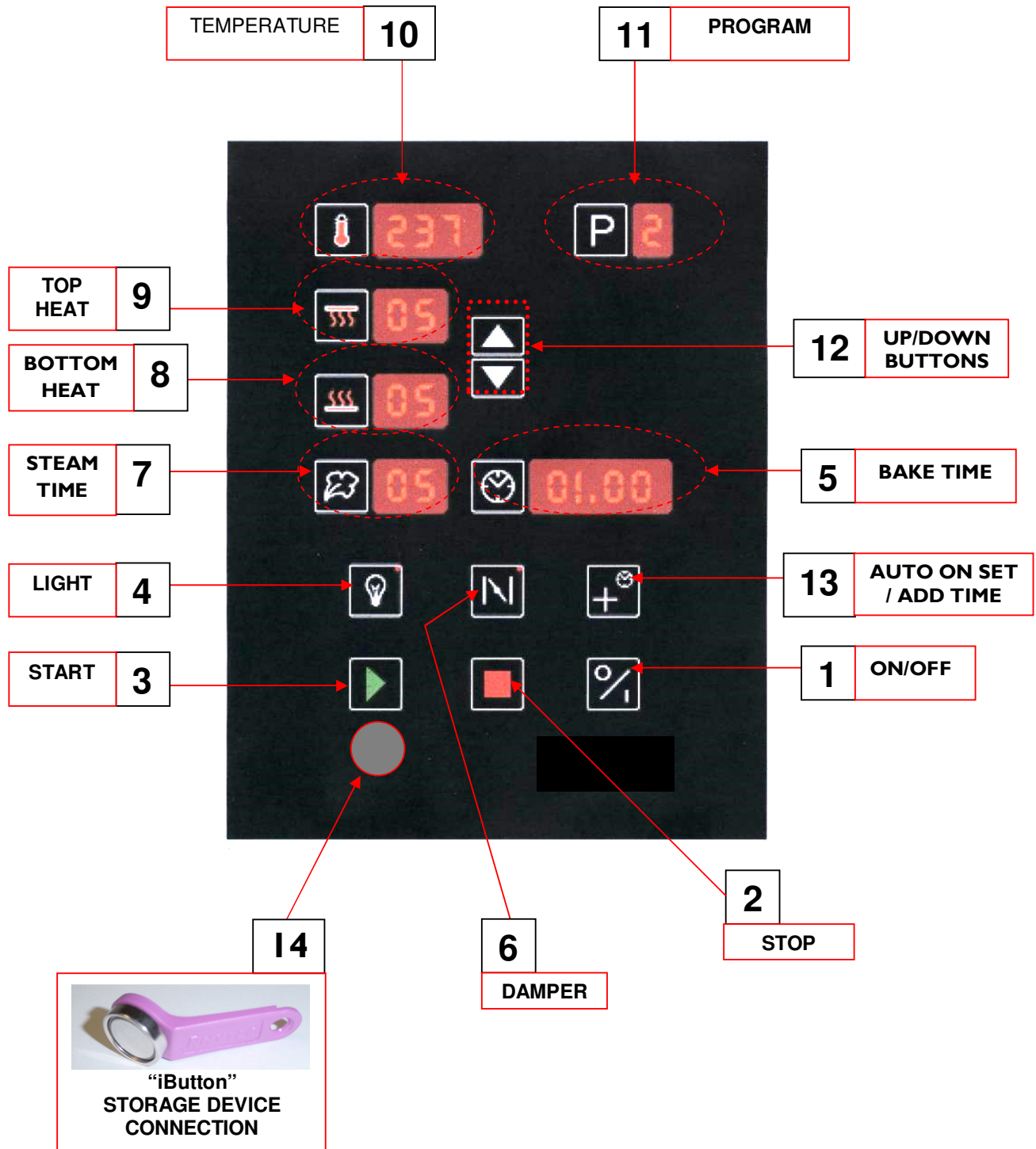

1. **ON/OFF**
*Turns controller on from standby mode.
Also used to exit setup mode.*
2. **STOP**
*Stops bake cycle.
Also used to go to function setup menu on power up (with button 3)*
3. **START**
*Starts bake cycle.
Also used to go to setup menu on power up (with button 2)
Also silences "2 minutes from end of bake" alarm when sounding.*
4. **LIGHT**
Interior light on/off.
*Red light shows when light is on.
Press to turn on and press again to turn off.*
5. **BAKE TIME/ADD TIME**
*Used to access set bake time and current time and day setup.
Also used to jump to day/hours/minutes when setting time and setting auto on time.*

IF 7 DAY TIMER ENABLED
*During bake cycle, Used to add extra bake time (1 minute each press).
At end of bake, press for two minutes and then once for each extra minute required.*
6. **DAMPER**
*Press to open damper. Press again to close damper.
(only works during bake).
Closes when stop pressed at end of bake and while steaming.
Red light shows when in open position.*
7. **STEAM TIME**
Press to access steam time and pre-steam mode.
If pre-steam function is enabled.
*Press once (reds dots appear). Use up down keys (12) to change to required setting. P0 = no pre-steam, P1 = 1 second, P2 = 2 seconds.
Press again to set steam time using up and down keys (12).
Press button again to save or wait 10 seconds to auto-save.*
If pre-steam function is not enabled.
*Press to set steam time using up and down keys (12).
Press button again to save or wait 10 seconds to auto-save.*
8. **BOTTOM HEAT**
*Press to set the bottom heat cycle percentage. Use up and down keys (12) to adjust the value.
Press button again to save or wait 10 seconds to auto-save.*
9. **TOP HEAT**
*Press to set the top heat cycle percentage. Use up and down keys (12) to adjust the value.
Press button again to save or wait 10 seconds to auto-save.*

10. TEMPERATURE

Press to set the bake temperature required. Use up and down keys (12) to adjust the value.

Press button again to save or wait 10 seconds to auto-save.

11. PROGRAM

Use up and down keys (12) to go to required program.

Press “p” for 5 seconds and all displays will flash.(A beep confirms settings are now saved)

12. UP/DOWN BUTTONS

Used to adjust values when required.

13. AUTO ON SET / ADD TIME

IF 7 DAY TIMER ENABLED

Used to access auto switch on times.

IF 7 DAY TIMER DISABLED

During bake cycle, Used to add extra bake time (1 minute each press).

At end of bake, press for two minutes and then once for each extra minute required.

14. “i BUTTON” CONNECTION

Used with special “iButton” storage device to change firmware of control board. (SEE NEXT PAGE FOR DETAILS)



“i Button” storage device

NOTE

Whenever power is connected to the board, 8 minutes must elapse before the oven will steam.

This allows the bottom elements to heat enough for steaming.

This will always happen if the power is disconnected and connected again, even if the oven is hot.

FIRMWARE UPDATE USING IBUTTON

Place unit into standby state so that the clock is displayed.

Place iButton onto probe.

Controller will upload data from iButton.

The bake temperature window will display a countdown (from 128 down to 0) as data is uploaded.

The top heat window displays the number of failed reads from the iButton. If this count reaches 08 then the upload will terminate (see Error conditions below).

Once the data has been uploaded and checked, the unit will enter a programming state.

The bake temperature window will display 'Prg'. This process should take around 8 secs to complete.

Note: during this programming phase, power must not be removed from the unit. Or the ibutton removed from the reader probe

If the power is interrupted, the re-programming of the Flash memory will be incomplete and the unit will cease to function. The only way to recover from this is to re-program the unit via a pc with a programming cable.

When the programming has completed, the unit will reset and **display the new firmware version in the time window**. This will be continuously displayed until the iButton is removed from the probe. The unit will then display the clock and continue to function as normal.

Error conditions

Error codes will be displayed in the bake temperature window if an upload fails.

In all the following situations, no changes will be made to the unit. Firmware is only updated if the upload from the iButton has been successful.

If an error is displayed and the iButton is still connected, the unit will wait for disconnection before resetting and functioning as normal. Another upload attempt may be made.

If the iButton is removed from the probe whilst uploading is in progress, the upload will terminate and the unit will reset.

E01:

If the unit fails to successfully read the iButton eight times in succession, then an E01 fault will be displayed in the bake temperature window. This might be caused by poor contact between the probe and the iButton, or bad data on the iButton.

Try cleaning the surface of the probe – any small amount of debris can affect the connection.

E02:

This error will be displayed if the file information on the iButton is incorrect or the iButton is blank (unprogrammed).

E03:

This error will be displayed if the iButton file CRC (cyclical redundancy check) does not match that calculated by the unit following a download i.e. bad iButton file.

OPERATION

1. With oven in standby mode (power on) press “on” button (1).
2. Press program button (11)
Using up and down keys (12) choose the set program required.

Oven will heat to the temperature required. Oven is ready for use when the display shows the temperature of the program chosen and if steam is required the display stops flashing.

Note:

If the oven is already hot and the set temperature is lower than the current temperature of the oven, the door should be opened to allow the temperature to drop.

3. Load oven as required.
To preserve heat, do not leave doors open more than needed to load oven.
4. Press start (3)
Press (13) at anytime during the bake to add 1 minute to the bake time.

DAMPER (6) Press to open damper. Press again to close damper
Red light shows when in open position.
(Closes if left open for 90 minutes)

5. IF ENABLED IN SETUP. 2 minutes from the end of the bake the buzzer will sound for 10 seconds. *Press start (3) to silence if required.*

6. At the end of the bake the buzzer will sound again. Press stop (2).

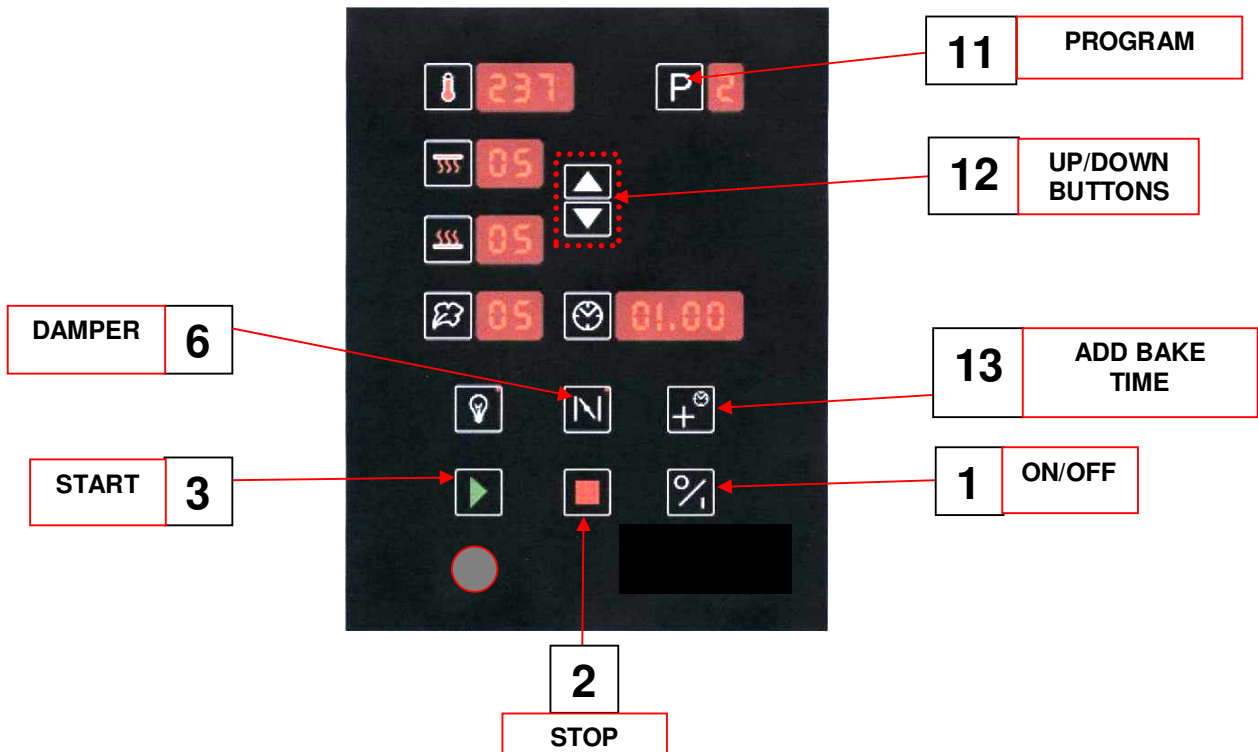

IF EXTRA TIME IS REQUIRED AT THE END OF THE BAKE (AFTER PRESSING STOP).

Press bake time (**13**) to set 2 minutes and 1 minute for each additional press.

After required time has been set, either press start (**3**) or wait 5 seconds and the bake countdown will start automatically.

NOTE

Steam is not available when using this extra time baking.

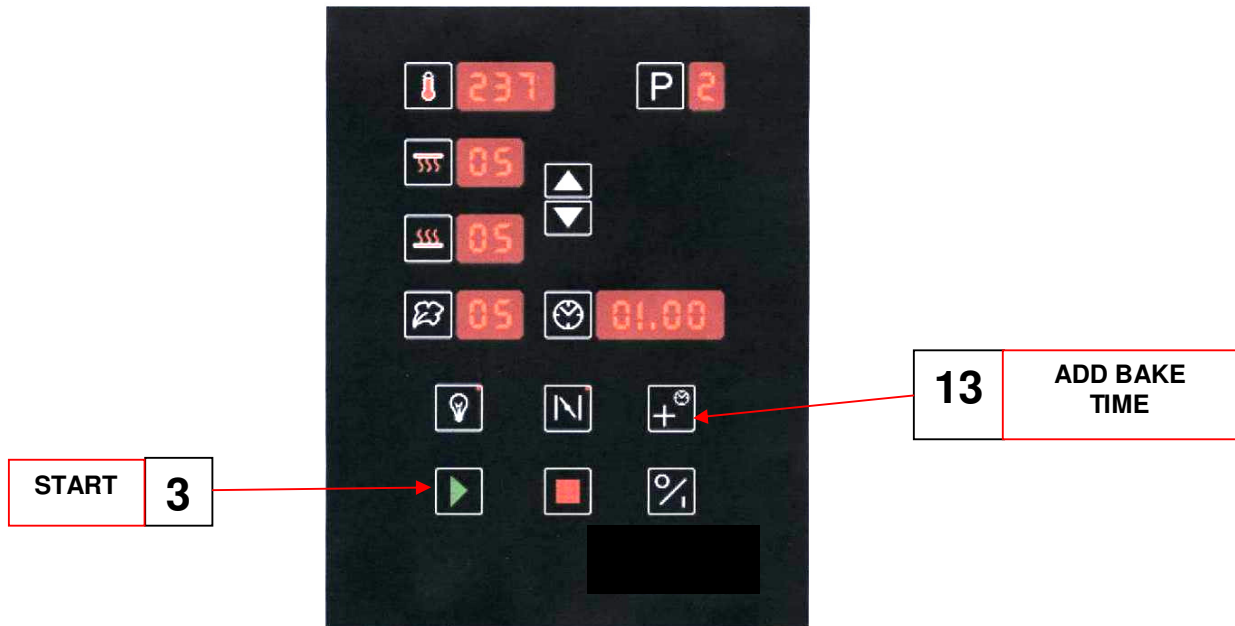

DAY AND TIME SET UP

Turn the power supply on.

This will put the oven in "standby mode" with only the clock showing.

Press clock button (5) and dots will flash under the hours in the time window.

Change value using up and down keys (12).

Press clock button (5) again and dots will flash under the minutes in the time window.

Change value using up and down keys (12).

Press clock button (5) again and day number will show.

Change value using up and down keys (12).

(usually day 1 is used as Monday)

To save the settings press clock button (5) within 5 seconds.

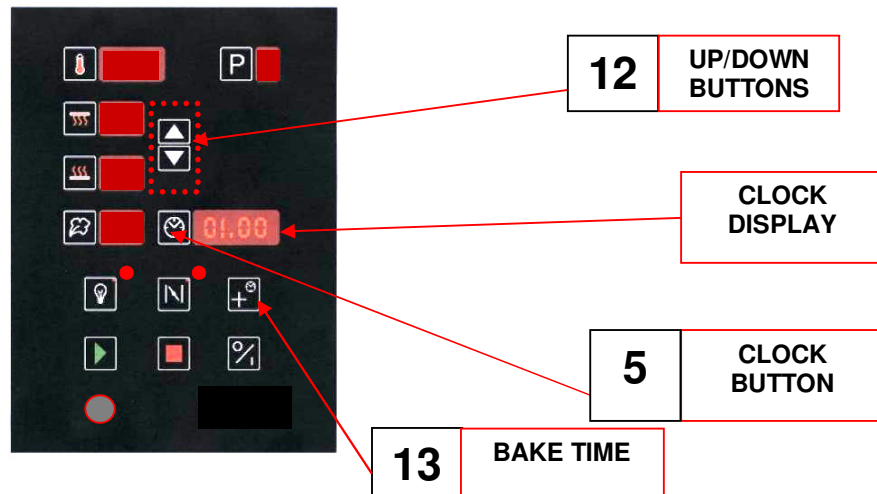

SETTING 7 DAY TIMER (if F15 enabled in parameters)

To set a timer event -

1. Switch the controller into standby(press the I/O button), I.e. only the current time displayed in the bake time window.

2. Press the bake time button (13) - timer day of week is displayed in temp window (dots appear next to day) to alter set day use the up/down arrow buttons (12)

3. Press the clock button (5), dots appear next to the hour display - to alter set hours use the up/down arrow button.

4. Press the clock button (5), dots appear next to the minute display - to alter set minutes use the up/down arrow buttons (12).

note - if you do not alter the hours/minutes within 6 seconds of selecting, the timer setup will default back to day setting

I.e. dots appear next to the P - in the temp window, just press the bake time button to get back to the time setup again.

Setting a time of 00.00 in the timer setup is a non event so will not switch on the controller.

5. Press the bake time button (13) to save and exit the timer setup .

SET UP MODE

To enter set up mode press both **start (3)** and **stop (2)** buttons and then **turn the power supply on at the same time.**

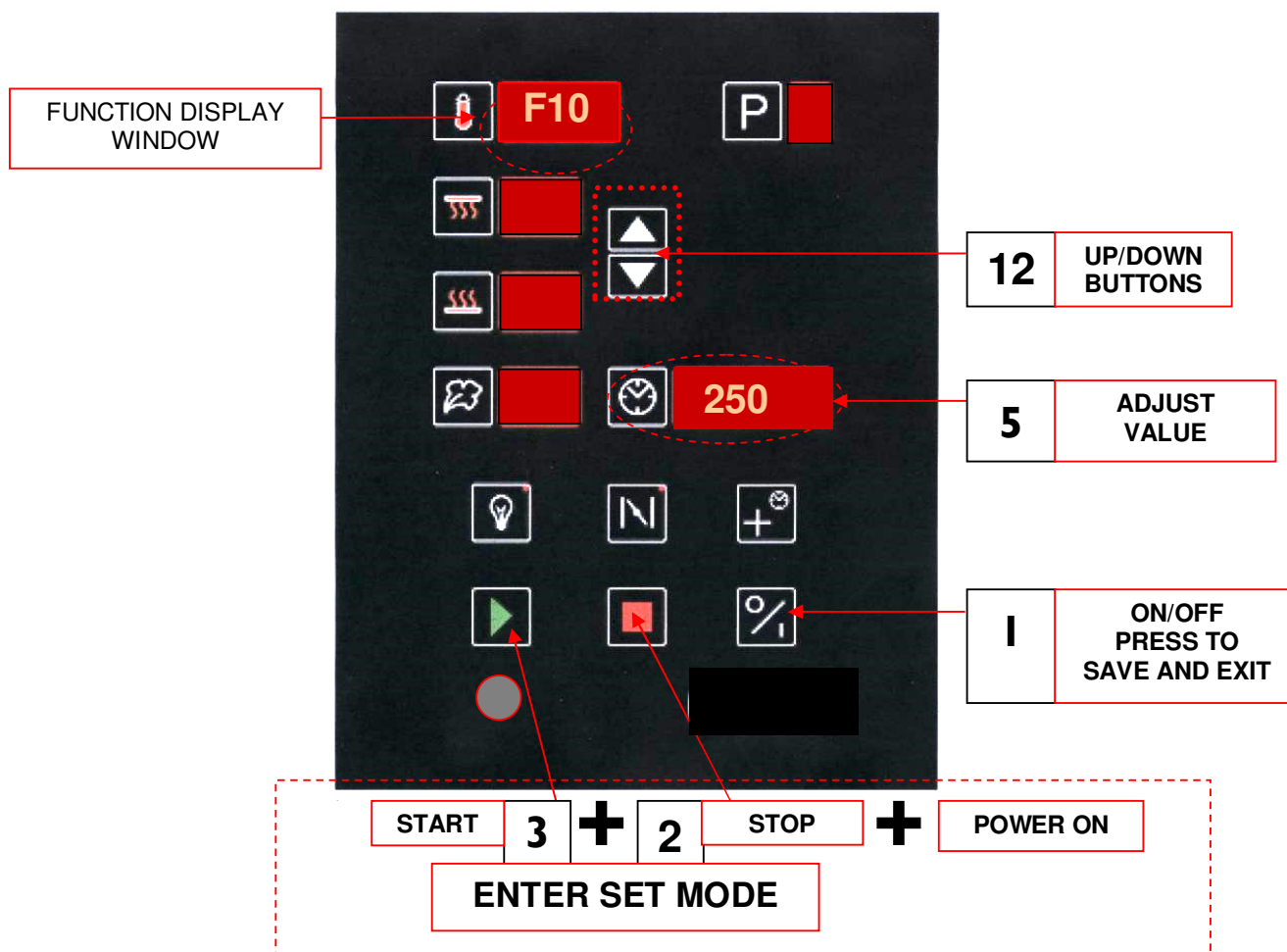

Change to the function required using up and down keys (12).
(see next page for function list)

Press clock button (5). (Dots appear on display)

Change value using up and down keys (12).

Press clock button (5) to save setting.

To exit set up mode and save changes press on/off (1).

NOTE

Any changes to the functions are only saved when exiting using on/off (1)

SET UP PARAMETER FUNCTION LIST (“F” SETTINGS)

- F1 - MONO CONSTANT** (FACTORY SET AT 210)
- F2 - TOP HEAT GAIN** (FACTORY SET AT 50)
- F3 - BOTTOM HEAT GAIN** (FACTORY SET AT 50)
- F4 - FRONT TOP ELEMENT OFFSET VALUE** (0-50) (FACTORY SET AT 25)
- F5 - DEG “C”, DEG”F”** (0=C, 1=F)
- F6 - “2 MINUTE FROM END OF BAKE ALARM** (ENABLE=1, DISABLE=0)
- F7 - PRE-STEAM** - (ENABLE=1, DISABLE=0)
- F8 - STEAM** - (ENABLE=1, DISABLE=0)
- F9 - BAKE TEMPERATURE OFF-SET** (+ - 25 DEG C)(set to -10)
- F10 - MAXIMUM SET TEMPERATURE LIMIT** (250 DEG “C” DEFAULT)
MAXIMUM TEMPERATURE 290 DEG “C”
- F11 - BAKE CONTROLS LOCKOUT** – (ENABLE=1, DISABLE=0)
(TO PREVENT OPERATOR CHANGING SET BAKE PARAMETERS)
- F12 SLEEP MODE DELAY TIME** - 60 MINUTES MAX. 0 = DISABLED

After switching on the controller, *before the sleep delay time is initiated (if enabled in F12)*, the set bake temperature must be reached, steam recovery time elapsed and a bake cycle started and stopped.

Once the stop bake button (2) has been pressed at the end of a bake, the sleep delay timer counts down until it has timed out. At this point the controller switches into sleep mode (*SLP displayed in temperature window*) and the oven will drop to a pre-set fall back temperature of 170 deg c, *which it will maintain*.

Note – *dampers closes when oven goes into sleep mode.*

Pressing any button during the sleep mode delay time will not affect the countdown, *apart from the O/I button which switches the controller off*. Pressing the start/stop bake buttons will reset the countdown timer.

Pressing any button while in sleep mode (*apart from lights on/off(4) – which operates as normal and the panel O/I on/off(1), which will turn the controller off*) will bring it out of sleep mode, at which point the oven will heat up to its previous set bake temperature (typical recovery time from 170 deg c to 230 deg c is 15 minutes approx)

Note – *if no buttons on the controller are pressed after exiting sleep mode, the controller will switch back into sleep mode, after the sleep delay time has expired.*

- F13 - INTERIOR LIGHT AUTO-TIMEOUT** - ON/OFF.
BETWEEN 1 AND 20 MINUTES (0 = disabled)
- F14 - 0-9 PROGRAMS**
Sets the number of programs available to the operator
- F15 - 7 DAY TIMER** - (ENABLE=1, DISABLE=0)
IF ENABLED, “SET BAKE” TIME ACTS AS EXTRA TIME BUTTON.
IF DISABLED, “AUTO ON SET” ACTS AS EXTRA TIME BUTTON.
- F16 - 8 HOUR COUNT DOWN TIMER** - (ENABLE=1, DISABLE=0)
AFTER 8 HOURS THE OVEN WILL TURN OFF (NOT DURING A BAKE CYCLE).
BEFORE SWITCH OFF, DISPLAYS WILL FLASH AND ALARM WILL SOUND.
IF ANY BUTTON IS PRESSED AT THIS TIME, AN HOUR WILL BE ADDED TO THE TIMER.
- F17 - LAMP OUTPUT SOFT START** - (ENABLE/DISABLE)
- F18 - STEAM TYPE** - (PLATE = 0, TROUGH = 1)
- F19 - STEAM TARGET TEMPERATURE** - (50 – 250 DEG C)

**ANY CHANGES MADE WILL ONLY BE SAVED BY PRESSING THE
ON/OFF BUTTON (1) WHEN EXITING**

CONTROLLER LAYOUT

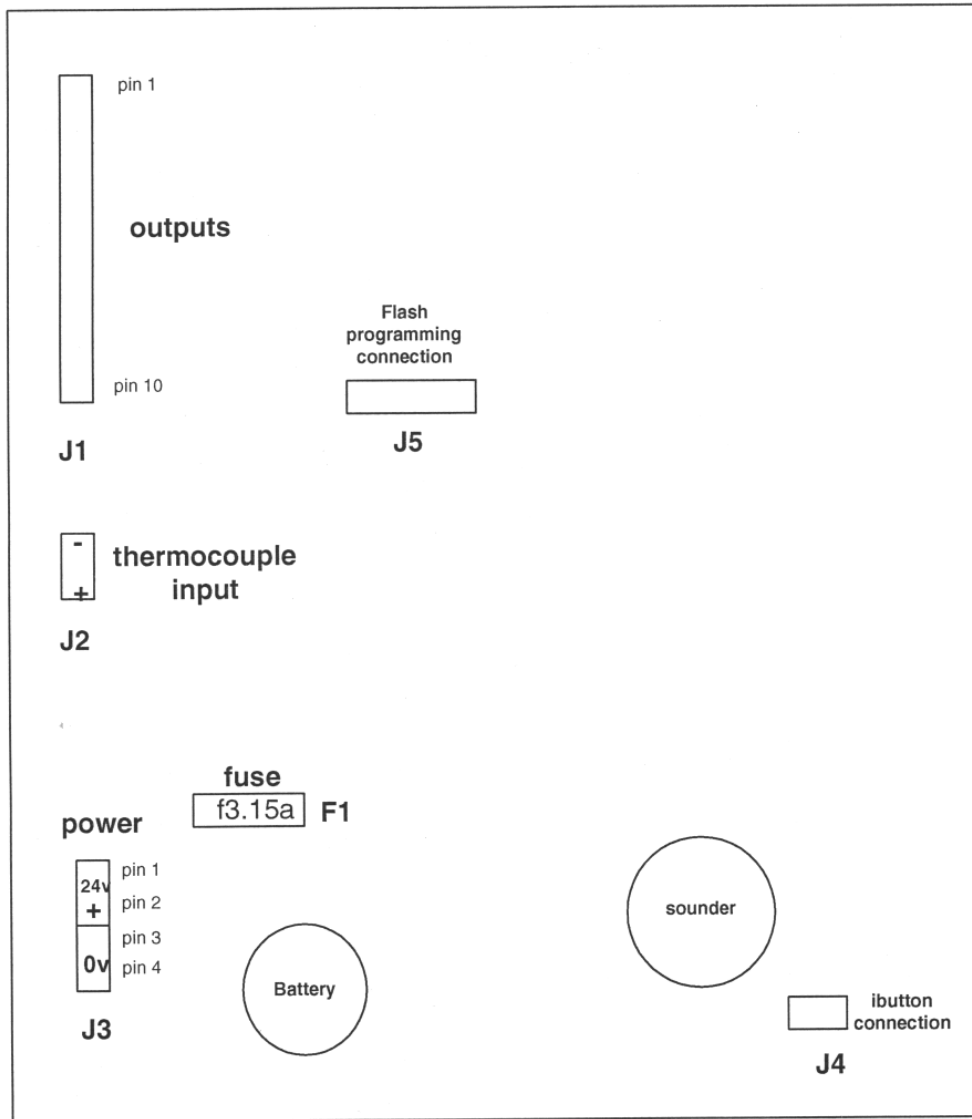

OUTPUTS

- PIN 1 – 24v
- PIN 2 – TOP HEAT OUTPUT
- PIN 3 -- TOP FRONT HEAT OUTPUT
- PIN 4 – BOTTOM HEAT OUTPUT
- PIN 5 – STEAM OUTPUT
- PIN 6 – DAMPER OUTPUT
- PIN 7 – LIGHT OUTPUT
- PIN 8 – CANOPY FAN RELAY OUTPUT
- PIN 9 – 24v
- PIN 10 – 24v

J4 MOVED 03/07

9 14-02-19

11.0 TROUBLESHOOTING

▪ NONE OF THE DECKS SWITCHED ON.

- Is main oven power on?
- Check if bakery main power supply time clock is working (if fitted).
- Is 7-day timer clock set correctly to bring oven on at the required time?

▪ ONE DECK HAS NOT SWITCHED ON.

- Check if individual deck timer is set to bring it on at the required time.

▪ UNEVEN OR PATCHY BAKE

- Door is being opened too often or too long whilst loading.
(front pale, back burnt).
- Faulty element.
- Top or bottom deck elements not functioning.
- Uneven loading.
- No supply voltage across a phase.
- Adjustment to front element control needed

▪ TEMPERATURE GOING WELL OVER SET TEMPERATURE

When empty the temperature of a deck oven can exceed the set baking temperature. This overheat is marginal when the deck is full of product. If the elements are continuing to work after the set temperature has been reached call Adamatic service. (Please allow up to 60deg.F difference before diagnosing a fault condition),

▪ POOR RECOVERY OF SET TEMPERATURE WHEN LOADED

- The doors may have been left open too long during loading, allowing heat to escape.
- The damper may have been left open during loading or baking allowing heat to escape.
- Top and/or bottom heat may not be working or set at a low value.
- No supply voltage across a phase.

ERROR MESSAGES

IF THESE NUMBERS APPEAR IN THE TEMPERATURE WINDOW PLEASE CHECK THE FOLLOWING:

888 – Indicates that the control board is above 80 degrees

999 – Indicates a problem with the thermocouple.
Check for connection problems or faulty thermocouple.

12.0 SERVICE

If a fault arises, please do not hesitate to contact the Customer Service Department, quoting the **machine serial number** on the silver information plate of the machine and on the front cover of this manual

MONO
Queensway
Swansea West Industrial Estate
Swansea.
SA5 4EB
UK

email: spares@monoequip.com
Web site: www.monoequip.com

Tel. Spares +44(0)1792 564039
Main +44(0)1792 561234
Fax. 01792 561016

LIGHT REPLACEMENT



DISCONNECT FROM POWER SUPPLY BEFORE REPLACING LIGHT BULBS

24v 20w LAMP PART NUMBER ... B855-94-008



1

HEX HEAD SOCKET SCREWS

UNSCREW PLATE NEXT TO LIGHT TO BE REPLACED



2

SLIDE FITTING OUT



3

REMOVE LIGHT FROM HOLDING SLOT AND UNCLIP FROM CABLE



4

REPLACE LIGHT AND REFIT ALL PARTS

RECONNECT POWER SUPPLY AND TEST



13.0 SPARES INFORMATION

OVEN SPARES

FROSTED GLASS	M257-02-00027
PLAIN GLASS	M257-02-00028
DOOR BUMPER STOP	M257-03-00027
BAKING TILE 3 ACROSS	M257-02-00046
2 ACROSS	M257-02-00047
1 ACROSS	M257-02-00048
HINGE PIN RHS	M257-03-00005
HINGE PIN LHS	M257-03-00009
BLACK DOOR HANDLE	A900-27-192
DOOR SPRING	M257-03-00017
WIRE ROPE	M257-03-00024
SPRING RETAINING PIN	M257-03-00025
PULLEY	M257-03-00015
PULLEY SPINDLE	M257-03-00013
DAMPER DRIVE COUPLING	M257-07-00007
ELEMENT GASKET	M245-02-01300
24 v 20w DICHROIC LAMP	B855-94-008

ELEMENT SPARES

3 ACROSS

TOP HEAT ELEMENT 1.0kW	B854-04-093
TOP HEAT ELEMENT 0.6kW	B854-04-091
BOTTOM HEAT ELEMENT 0.75kW	B854-04-092

2 ACROSS

TOP HEAT ELEMENT 0.65kW	B854-04-102
TOP HEAT ELEMENT 0.4kW	B854-04-100
BOTTOM HEAT ELEMENT 0.5kW	B854-04-101

1 ACROSS

TOP HEAT ELEMENT 0.325kW	B854-04-111
TOP HEAT ELEMENT 0.2kW	B854-04-109
BOTTOM HEAT ELEMENT 0.25kW	B854-04-110



14.0 ELECTRICS

PARTS LIST FOR DRAWINGS FOLLOWING – 3 TRAY WIDE

F1	HEATERS MCB	B872-22-007	Single phase only
F2	HEATERS MCB	B872-22-007	
F3	HEATERS MCB	B872-22-007	
F4	CONTROL POWER SUPPLY MCB	B872-22-062	
F5	OVERHEAT THERMOSTAT	B888-30-014	
T1	CONTROL CIRCUIT POWER SUPPLY	B801-93-005	
K1	TOP HEAT CONTACTOR	B801-08-021	
K2	BOTTOM HEAT CONTACTOR	B801-08-021	
Y1	WATER SOLENOID (10mm pipe)	A900-34-349(up to May 2007)	
	WATER SOLENOID (8mm pipe)	A900-34-365 (after May 2007)	
H1	INTERIOR LIGHT	B855-94-008	
B1	OVEN THERMOCOUPLE	B873-95-003	
U1	MAIN LED PRINTED CIRCUIT BOARD	M257-25-00000	
D1	DAMPER SOLENOID	B749-83-004	
R1	TOP HEAT ELEMENT 1.0kW	B854-04-093	
R2	TOP HEAT ELEMENT 0.6kW	B854-04-091	
R3	TOP HEAT ELEMENT 0.6kW	B854-04-091	
R4	TOP HEAT ELEMENT 0.6kW	B854-04-091	
R5	TOP HEAT ELEMENT 0.6kW	B854-04-091	
R6	TOP HEAT ELEMENT 0.6kW	B854-04-091	
R7	TOP HEAT ELEMENT 0.6kW	B854-04-091	
R8	BOTTOM HEAT ELEMENT 0.75kW	B854-04-092	
R9	BOTTOM HEAT ELEMENT 0.6kW	B854-04-091	
R10	BOTTOM HEAT ELEMENT 0.6kW	B854-04-091	
R11	BOTTOM HEAT ELEMENT 0.6kW	B854-04-091	
R12	BOTTOM HEAT ELEMENT 0.6kW	B854-04-091	
R13	BOTTOM HEAT ELEMENT 0.6kW	B854-04-091	
R14	BOTTOM HEAT ELEMENT 0.6kW	B854-04-091	
S1	SOUNDER	B723-92-002 (ONLY COLOUR OVENS)	

PARTS LIST FOR DRAWINGS FOLLOWING – 2 TRAY WIDE

F1	HEATERS MCB	B872-22-006	Single phase only
F2	HEATERS MCB	B872-22-006	
F3	HEATERS MCB	B872-22-006	
F4	CONTROL POWER SUPPLY MCB	B872-22-062	
F5	OVERHEAT THERMOSTAT	B888-30-014	
T1	CONTROL CIRCUIT POWER SUPPLY	B801-93-005	
K1	TOP HEAT CONTACTOR	B801-08-021	
K2	BOTTOM HEAT CONTACTOR	B801-08-021	
Y1	WATER SOLENOID (10mm pipe)	A900-34-349(up to May 2007)	
	WATER SOLENOID (8mm pipe)	A900-34-365 (after May 2007)	
H1	INTERIOR LIGHT	B855-94-008	
B1	OVEN THERMOCOUPLE	B873-95-003	
U1	MAIN LED PRINTED CIRCUIT BOARD	M257-25-00000	
D1	DAMPER SOLENOID	B749-83-004	
R1	TOP HEAT ELEMENT 0.65kW	B854-04-102	
R2	TOP HEAT ELEMENT 0.4kW	B854-04-100	
R3	TOP HEAT ELEMENT 0.4kW	B854-04-100	
R4	TOP HEAT ELEMENT 0.4kW	B854-04-100	
R5	TOP HEAT ELEMENT 0.4kW	B854-04-100	
R6	TOP HEAT ELEMENT 0.4kW	B854-04-100	
R7	TOP HEAT ELEMENT 0.4kW	B854-04-100	
R8	BOTTOM HEAT ELEMENT 0.5kW	B854-04-101	
R9	BOTTOM HEAT ELEMENT 0.4kW	B854-04-100	
R10	BOTTOM HEAT ELEMENT 0.4kW	B854-04-100	
R11	BOTTOM HEAT ELEMENT 0.4kW	B854-04-100	
R12	BOTTOM HEAT ELEMENT 0.4kW	B854-04-100	
R13	BOTTOM HEAT ELEMENT 0.4kW	B854-04-100	
R14	BOTTOM HEAT ELEMENT 0.4kW	B854-04-100	
S1	SOUNDER	B723-92-002 (ONLY COLOUR OVENS)	

PARTS LIST FOR DRAWINGS FOLLOWING – 1 TRAY WIDE

F1	HEATERS MCB	B872-22-005	Single phase only
F2	HEATERS MCB	B872-22-005	
F3	HEATERS MCB	B872-22-005	
F4	CONTROL POWER SUPPLY MCB	B872-22-062	
F5	OVERHEAT THERMOSTAT	B888-30-014	
T1	CONTROL CIRCUIT POWER SUPPLY	B801-93-005	
K1	TOP HEAT CONTACTOR	B801-08-021	
K2	BOTTOM HEAT CONTACTOR	B801-08-021	
Y1	WATER SOLENOID (10mm pipe)	A900-34-349(up to May 2007)	
	WATER SOLENOID (8mm pipe)	A900-34-365 (after May 2007)	
H1	INTERIOR LIGHT	B855-94-008	
B1	OVEN THERMOCOUPLE	B873-95-003	
U1	MAIN LED PRINTED CIRCUIT BOARD	M257-25-00000	
D1	DAMPER SOLENOID	B749-83-004	
R1	TOP HEAT ELEMENT 0.35kW	B854-04-111	
R2	TOP HEAT ELEMENT 0.2kW	B854-04-109	
R3	TOP HEAT ELEMENT 0.2kW	B854-04-109	
R4	TOP HEAT ELEMENT 0.2kW	B854-04-109	
R5	TOP HEAT ELEMENT 0.2kW	B854-04-109	
R6	TOP HEAT ELEMENT 0.2kW	B854-04-109	
R7	TOP HEAT ELEMENT 0.2kW	B854-04-109	
R8	BOTTOM HEAT ELEMENT 0.25kW	B854-04-110	
R9	BOTTOM HEAT ELEMENT 0.2kW	B854-04-109	
R10	BOTTOM HEAT ELEMENT 0.2kW	B854-04-109	
R11	BOTTOM HEAT ELEMENT 0.2kW	B854-04-109	
R12	BOTTOM HEAT ELEMENT 0.2kW	B854-04-109	
R13	BOTTOM HEAT ELEMENT 0.2kW	B854-04-109	
R14	BOTTOM HEAT ELEMENT 0.2kW	B854-04-109	
S1	SOUNDER	B723-92-002 (ONLY COLOUR OVENS)	

TOP CANOPY MK 2 DECK OVEN MCB WIRING

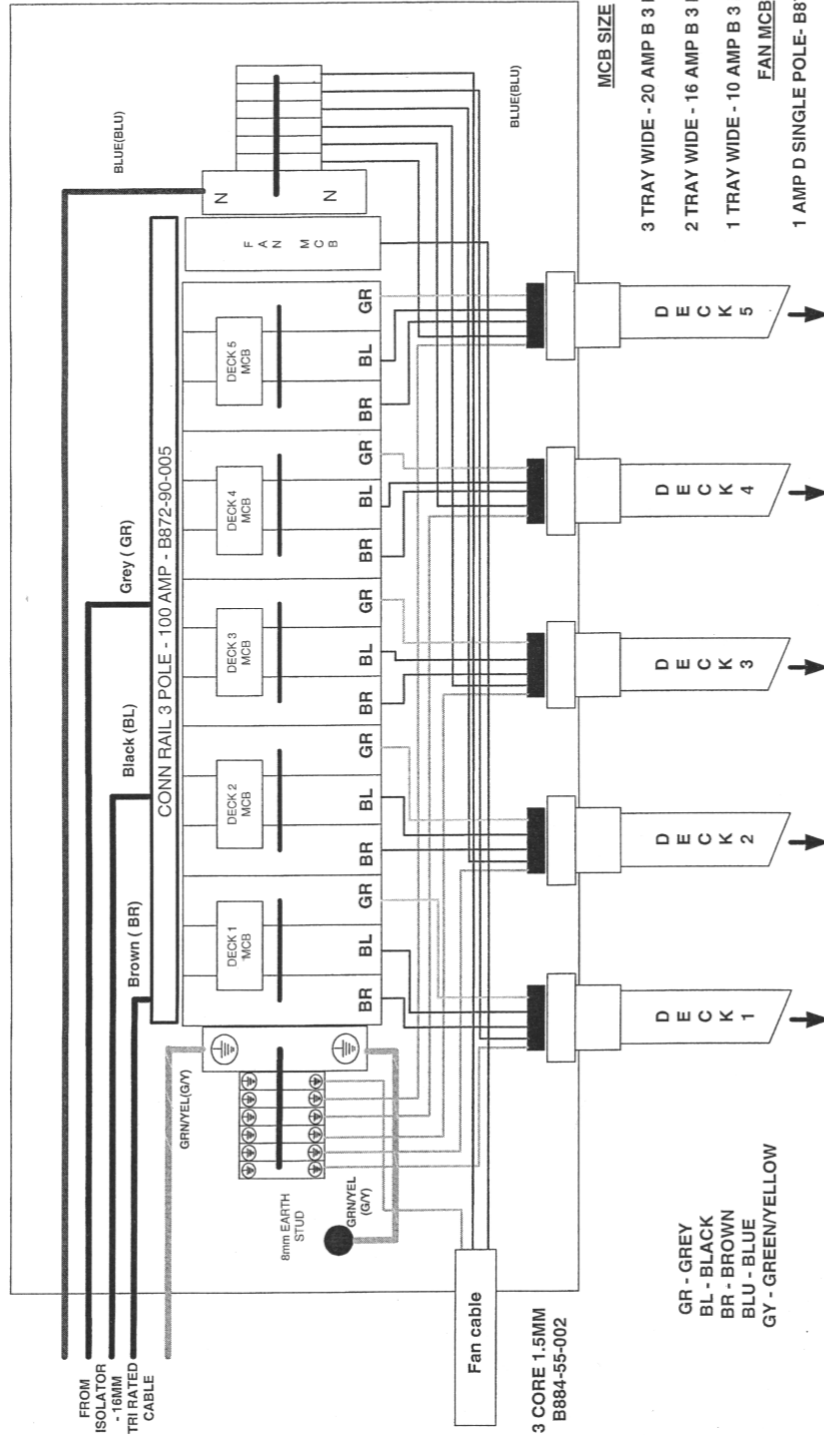

- MCB SIZE**
- 3 TRAY WIDE - 20 AMP B 3 POLE- B872-22-027
 - 2 TRAY WIDE - 16 AMP B 3 POLE- B872-22-026
 - 1 TRAY WIDE - 10 AMP B 3 POLE- B872-22-025
- FAN MCB**
- 1 AMP D SINGLE POLE- B872-22-060

WIND EQUIPMENT SWANSEA WEST IND PARK SWANSEA SA4 4AB TEL: (01792) 812300 FAX: (01792) 812118 Email: engineering@windsocap.com	TITLE: UK/EUROPE TOP SECTION MCB WIRING DISTRIBUTION UNIT	
	DRAWN: ADT	ELECTRICAL APPROVED BY:
DATE: 19-2-07	DRAWING NO.: M257E25-52300	REV:
ELECTRICAL SPECIFICATIONS: 400V 50/60 HZ 3 PHASE + N+E	ADT	REV:

MAINS CABLE TO EACH DECK(TB1) 2.5MM 5 CORE TYPE B B843-57-003

GR - GREY
 BL - BLACK
 BR - BROWN
 BLU - BLUE
 GY - GREEN/YELLOW

DX UK Modular MK2 Deck Oven Interlink Detail

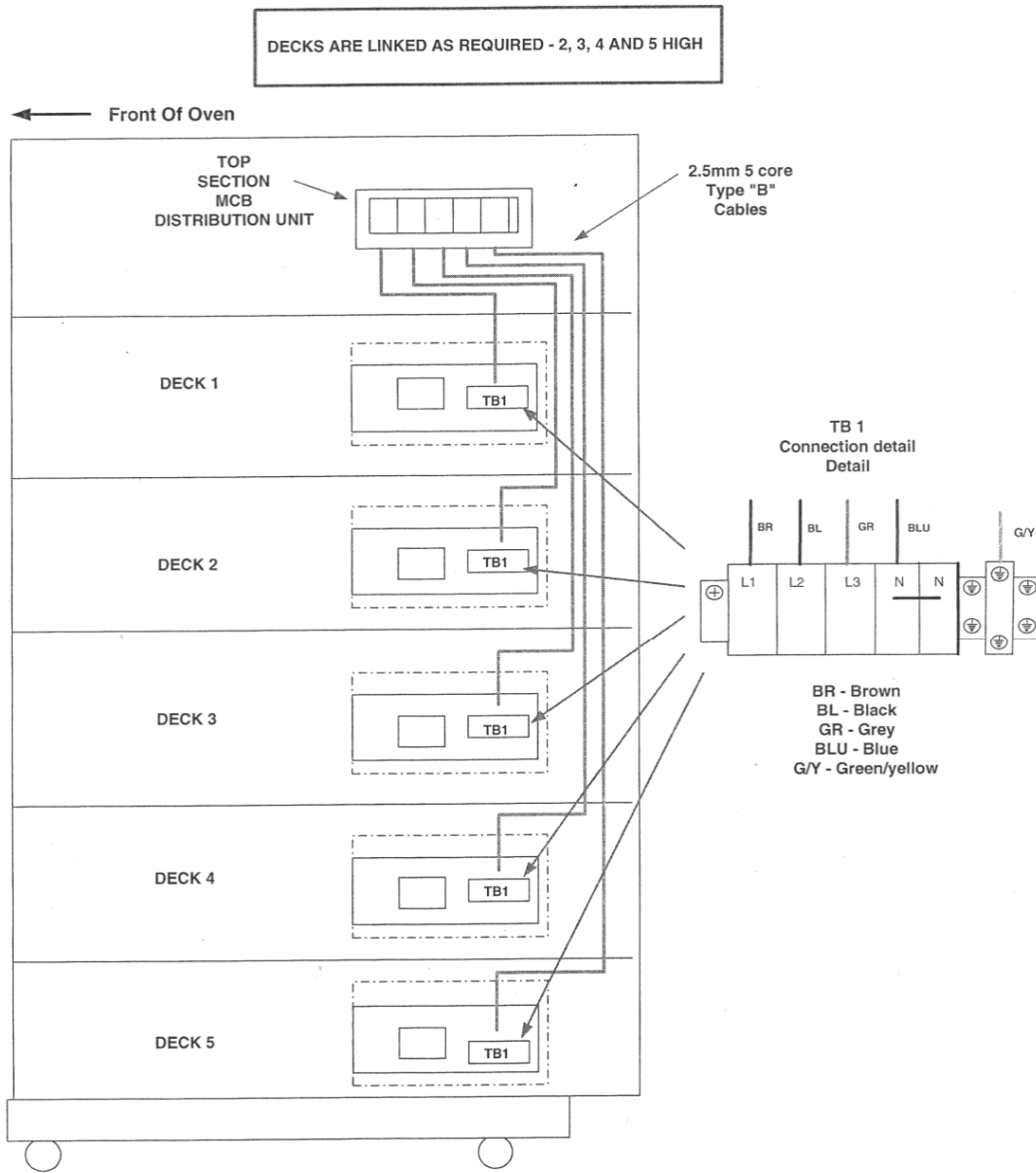

<p style="font-size: 8px; margin: 0;"> MONO EQUIPMENT QUEENSWAY SWANSEA WEST IND PARK SWANSEA SAG AER TEL: (01792) 861504 FAX: (01792) 861016 Email: engineering@monoquip.com </p>	<p style="font-size: 8px; margin: 0;"> TITLE: UK/EUROPE MODULAR MK 2 DECK OVEN INTERLINK DETAIL </p>		
<p style="font-size: 8px; margin: 0;"> ELECTRICAL SPECIFICATIONS: 400V 50/60 HZ 3 PHASE + N+E </p>	<p style="font-size: 8px; margin: 0;"> DRAWN: ADT </p>	<p style="font-size: 8px; margin: 0;"> ELECTRICALLY APPROVED BY: ADT </p>	
	<p style="font-size: 8px; margin: 0;"> DATE: 19-2-07 </p>	<p style="font-size: 8px; margin: 0;"> DRAWING NO. M257E25-52500 </p>	<p style="font-size: 8px; margin: 0;"> REV: - </p>

IF IN ANY DOUBT - ASK

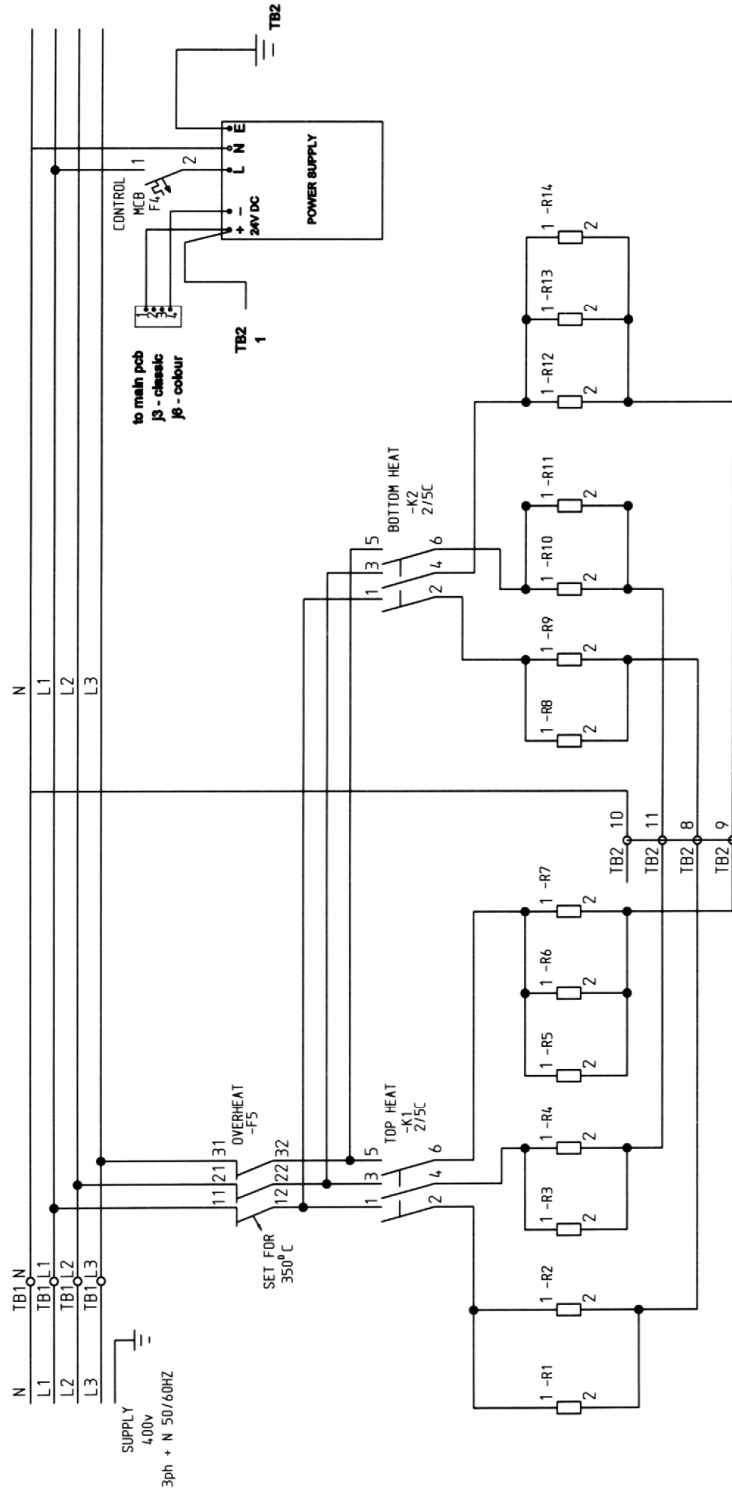

REV	SIG	DATE	REVISION	ECN NO.
<p>MONO EQUIPMENT 115 WILSON ROAD WEST IND PARK SWANSEA SA5 4EB. TEL: 01792 581234 FAX: 01792 581016</p>				
<p>TITLE: MODULAR DECK OVEN POWER CIRCUIT TOP-BOTTOM HEAT</p>				
<p>DRAWN: RAC</p>				
<p>ELECTRICALLY APPROVED BY:- AT</p>				
<p>ELECTRICAL SPECIFICATIONS:- 400V 3PH & N + E 50/60 HZ</p>				
<p>DATE: 7/3/07</p>				
<p>DRAWING NO.: M257E25-30000</p>				
<p>REV: —</p>				

COPYRIGHT © 1998 - THIS DESIGN/DRAWING IS THE PROPERTY OF MONO EQUIPMENT LTD. AND MUST NOT BE REPRODUCED, COPIED, NOR ITS CONTENTS DISCLOSED WITHOUT PRIOR WRITTEN PERMISSION.

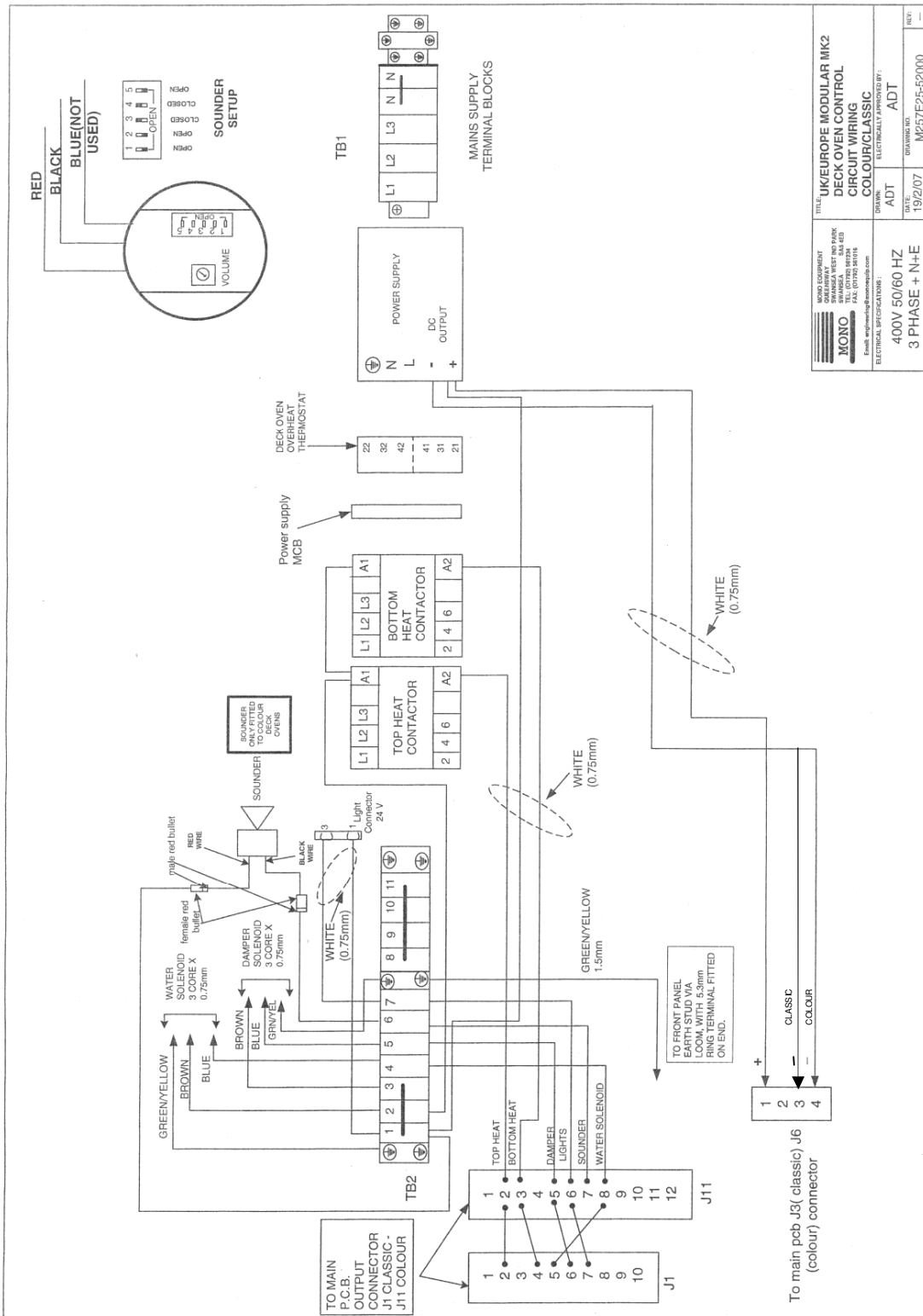

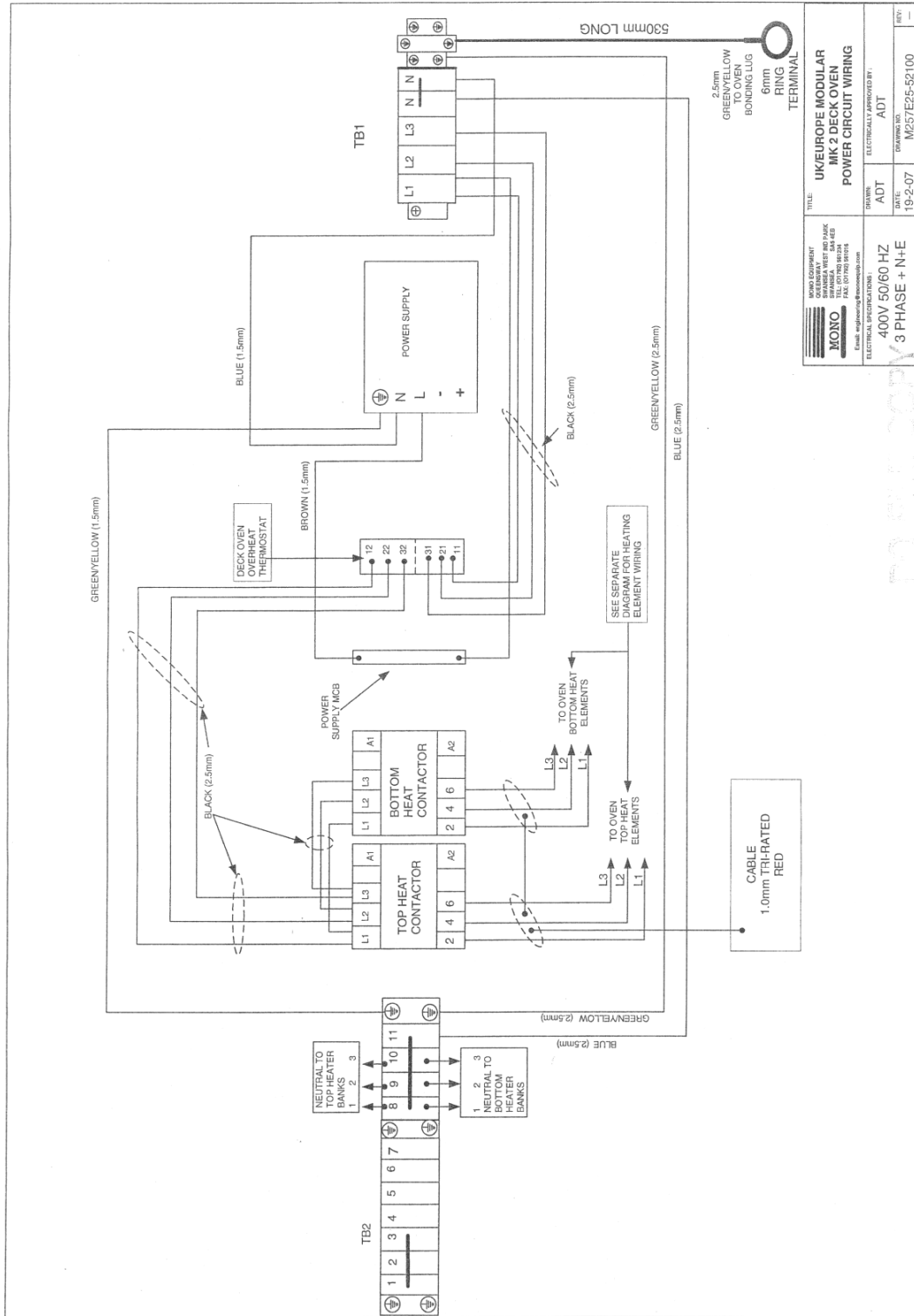

MONO <small>WORLDWIDE EQUIPMENT 11/11 SHARADA WEST, 80 D'AVANCE STREET, KARAIKUDI, TAMIL NADU 625 020 INDIA TEL: 0471 2503131 FAX: 0471 2503132 Email: engineering@monocorp.com</small>	TITLE: UN/EUROPE MODULAR MK2 DECK OVEN POWER CIRCUIT WIRING	DRAWN: ADT DATE: 19-2-07	ELECTRICAL APPROVED BY: ADT DRAWING NO: M257E25-52100 REV: —
	ELECTRICAL SPECIFICATIONS: 400V 50/60 HZ 3 PHASE + N+E		

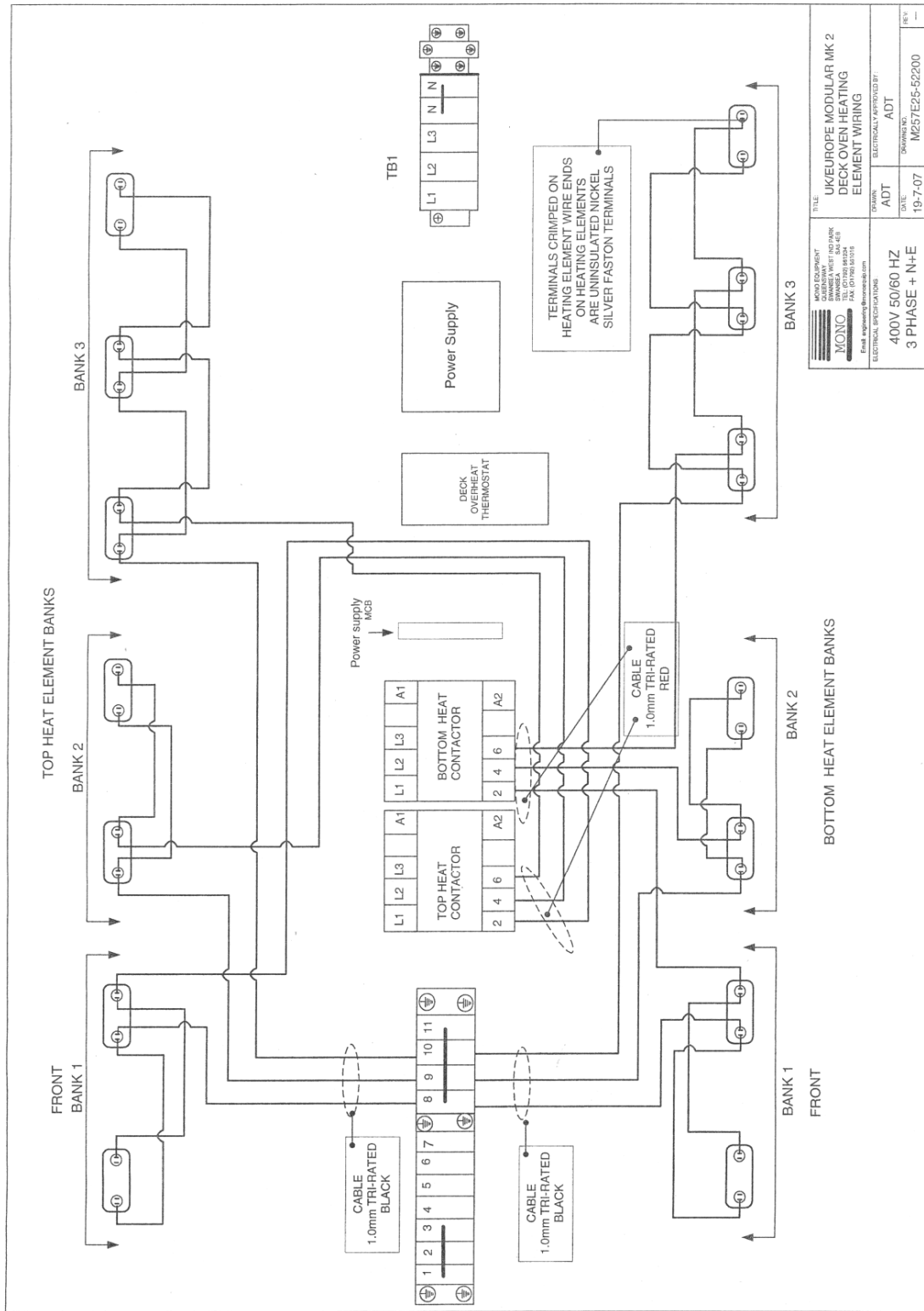

MODULAR DECK MK 2 MAIN ISOLATOR WIRING

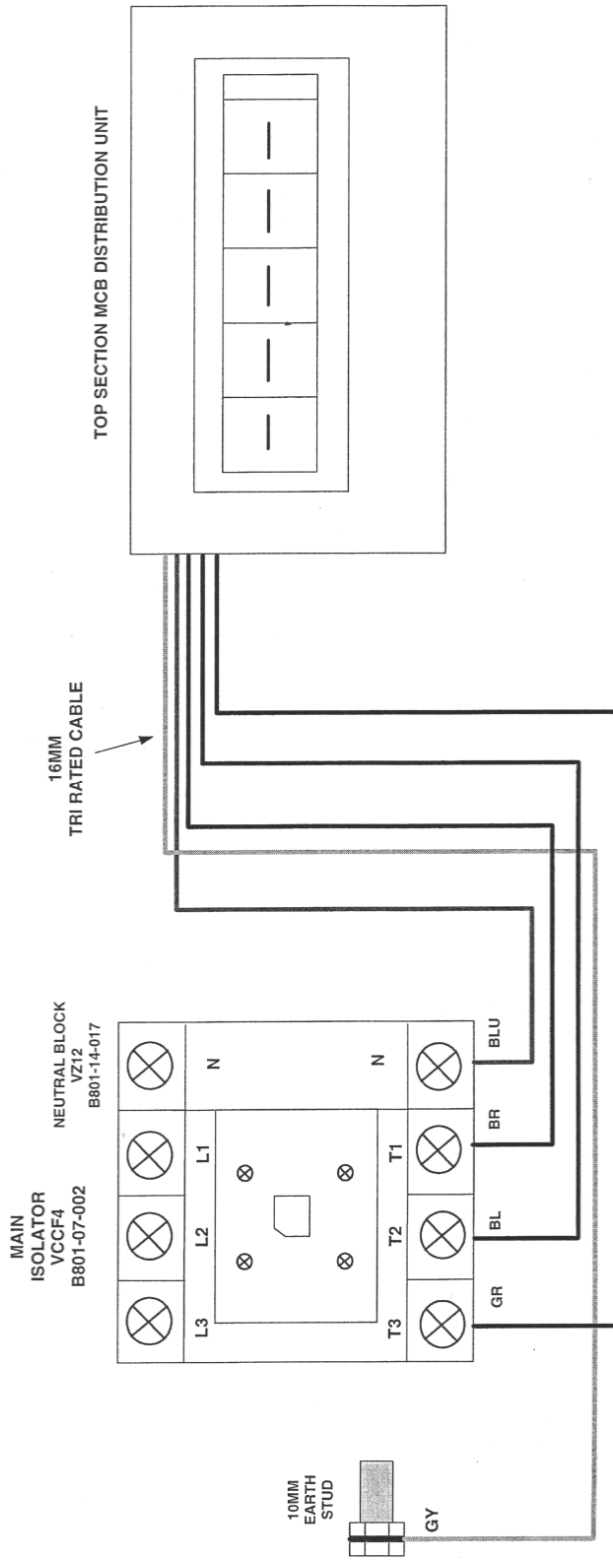

- GR - GREY
- BL - BLACK
- BR - BROWN
- BLU - BLUE
- GY - GREEN/YELLOW

<p>MONO COMPANY SULFORDWAY SALFORD GRANVILLE SHEFFIELD S18 4AB TEL: 01755 801714 Email: engineering@monocompany.com</p>	<p>TITLE: UK/EUROPE MODULAR MK 2 DECK OVEN ISOLATOR WIRING</p>	
	<p>DRAWN: ADT</p>	<p>ELECTRICALLY APPROVED BY: ADT</p>
<p>ELECTRICAL SPECIFICATIONS: 400V 50/60 HZ 3 PHASE + N+E</p>	<p>DATE: 19-2-07</p>	<p>DRAWING NO.: M257E25-52400</p>
		<p>REV: —</p>

DX UK/Europe Modular MK2 Colour Smart Controller Connections Layout

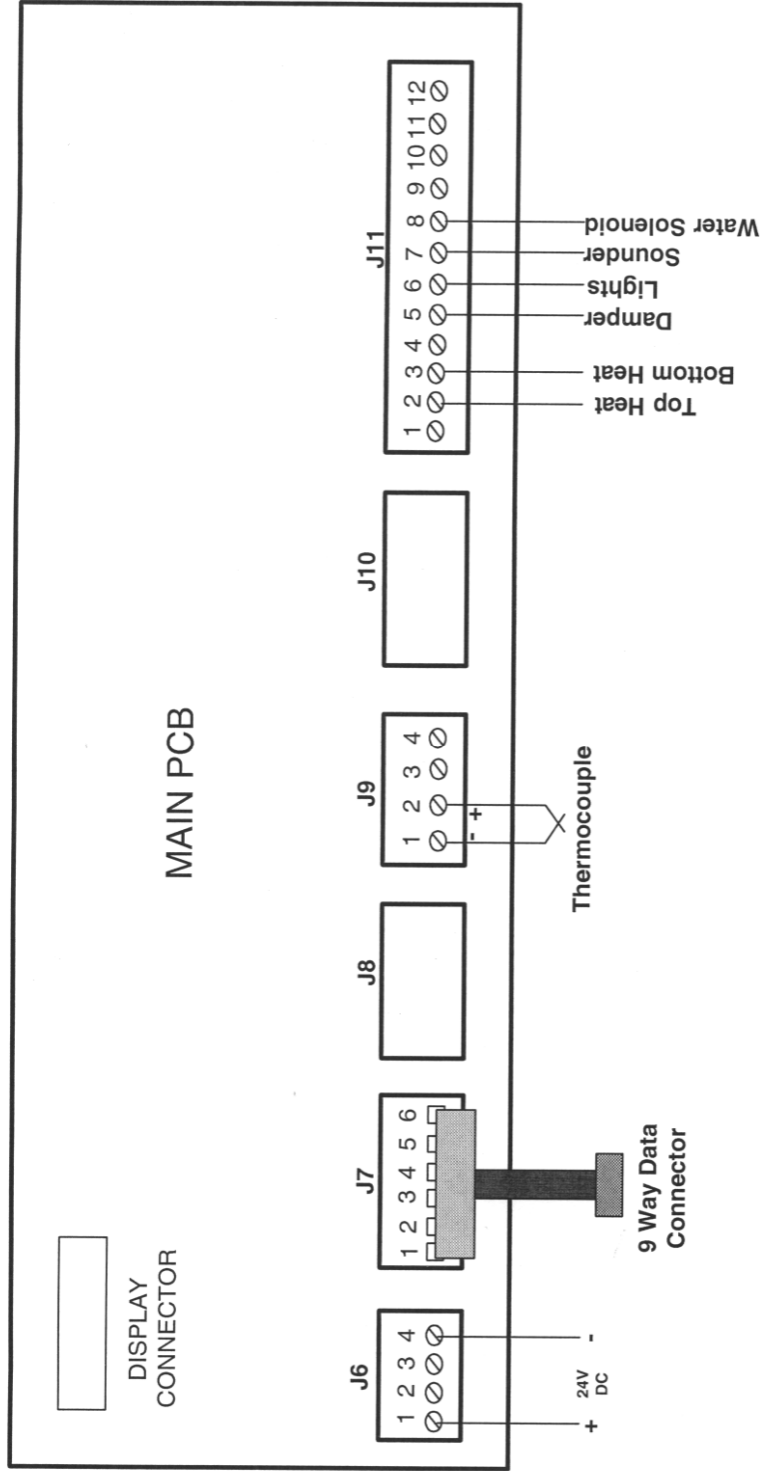

 <p>MONO EQUIPMENT 15 SWANSEA WEST IND PARK SWANSEA SA5 4EB TEL: (01792) 581234 FAX: (01792) 581016 Email: engineering@monoequip.com</p>	TITLE: UK/EUROPE MODULAR MK 2 DECK OVEN COLOUR CONTROLLER CONNECTION LAYOUT	
	DRAWN: ADT DATE: 19-2-07	ELECTRICALLY APPROVED BY: ADT DRAWING NO. M257E25-52600
ELECTRICAL SPECIFICATIONS: 400V 50/60 HZ 3 PHASE + N+E		REV: —

Canopy fan wiring Mk 2 Modular Deck UK/Europe

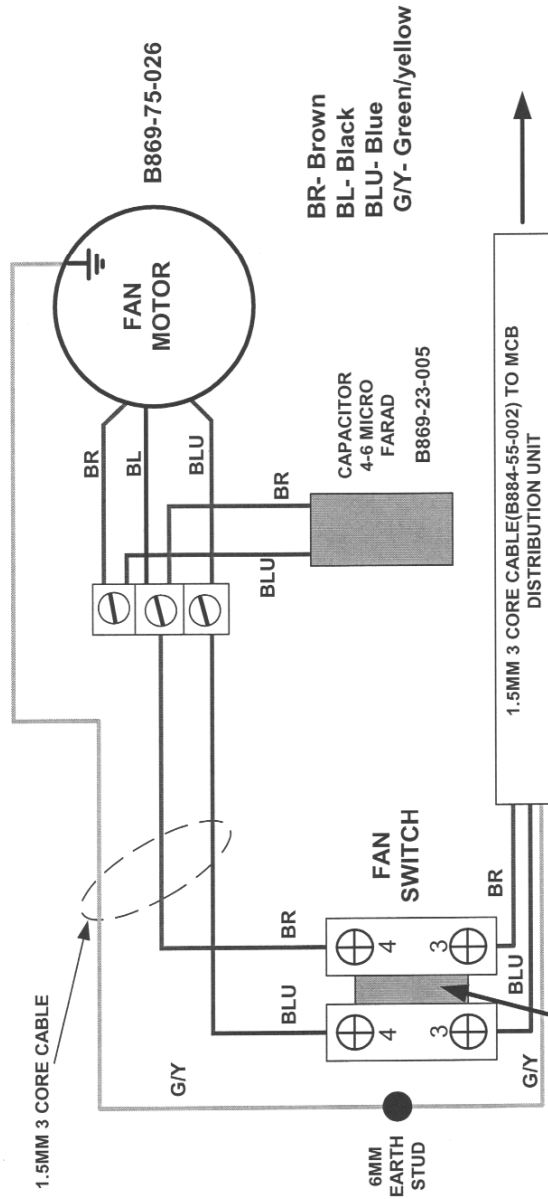

<p>MONO EQUIPMENT QUERNSEWAY SWANSEA WEST IND PARK SWANSEA SA3 4EB TEL: (01792) 581016 FAX: (01792) 581016 Email: engineering@monoequip.com</p>	<p>TITLE: DX MODULAR MK 2 UK/ EUROPE CANOPY FAN WIRING</p>	
	<p>MONO</p>	<p>ELECTRICAL SPECIFICATIONS: 230V 50/60 HZ 1 PHASE + N+E</p>
<p>Electrical Specifications:</p>	<p>DRAWN: ADT DATE: 19-2-07</p>	<p>ELECTRICALLY APPROVED BY: ADT DRAWING NO. M257E25-52700 REV: —</p>

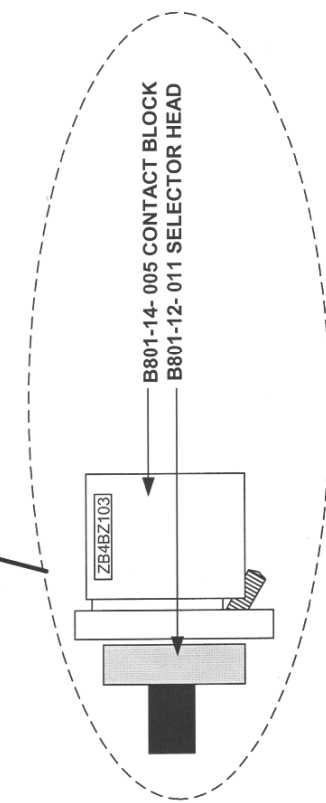

**ELECTRICAL PANEL MAIN COMPONENTS
3 PHASE**

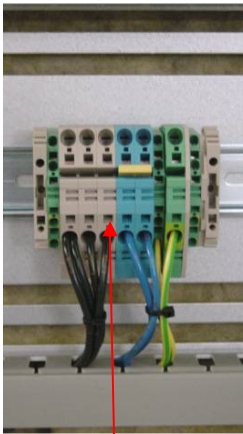
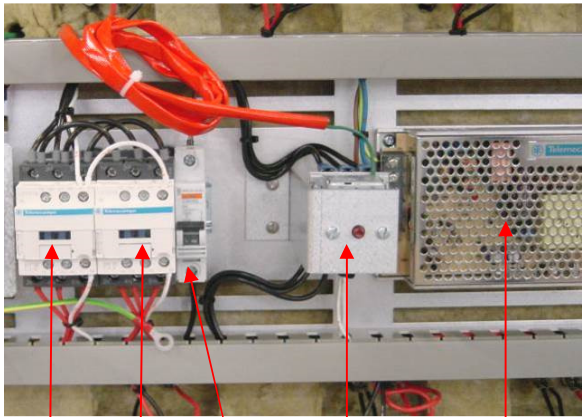
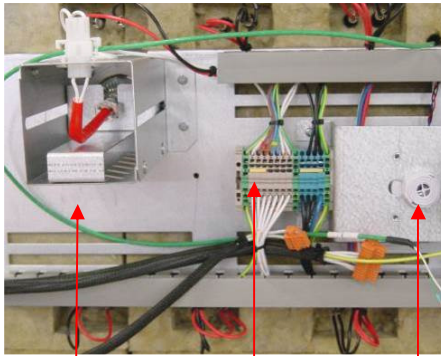
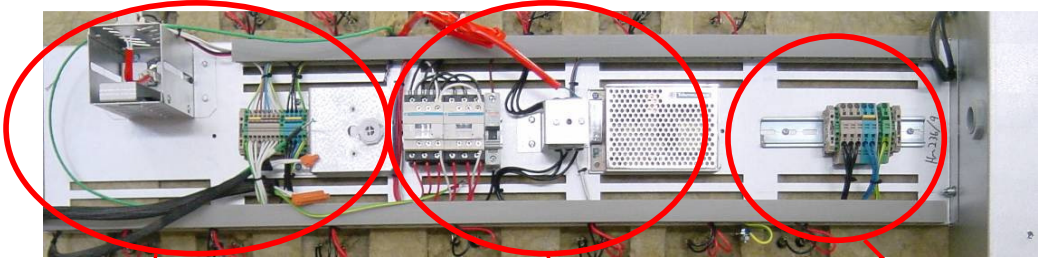

H1

TB2

S1

K1

K2

F4

F5

POWER SUPPLY

TB1

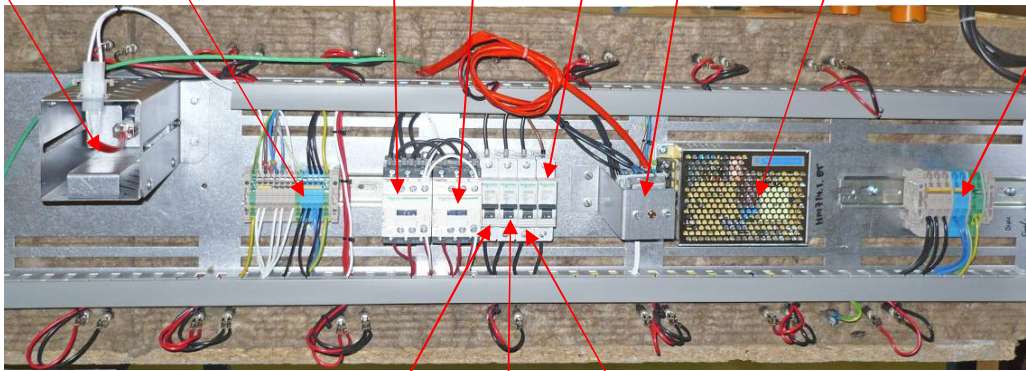

F1

F2

F3

**ELECTRICAL PANEL MAIN COMPONENTS
1 PHASE**

I PHASE

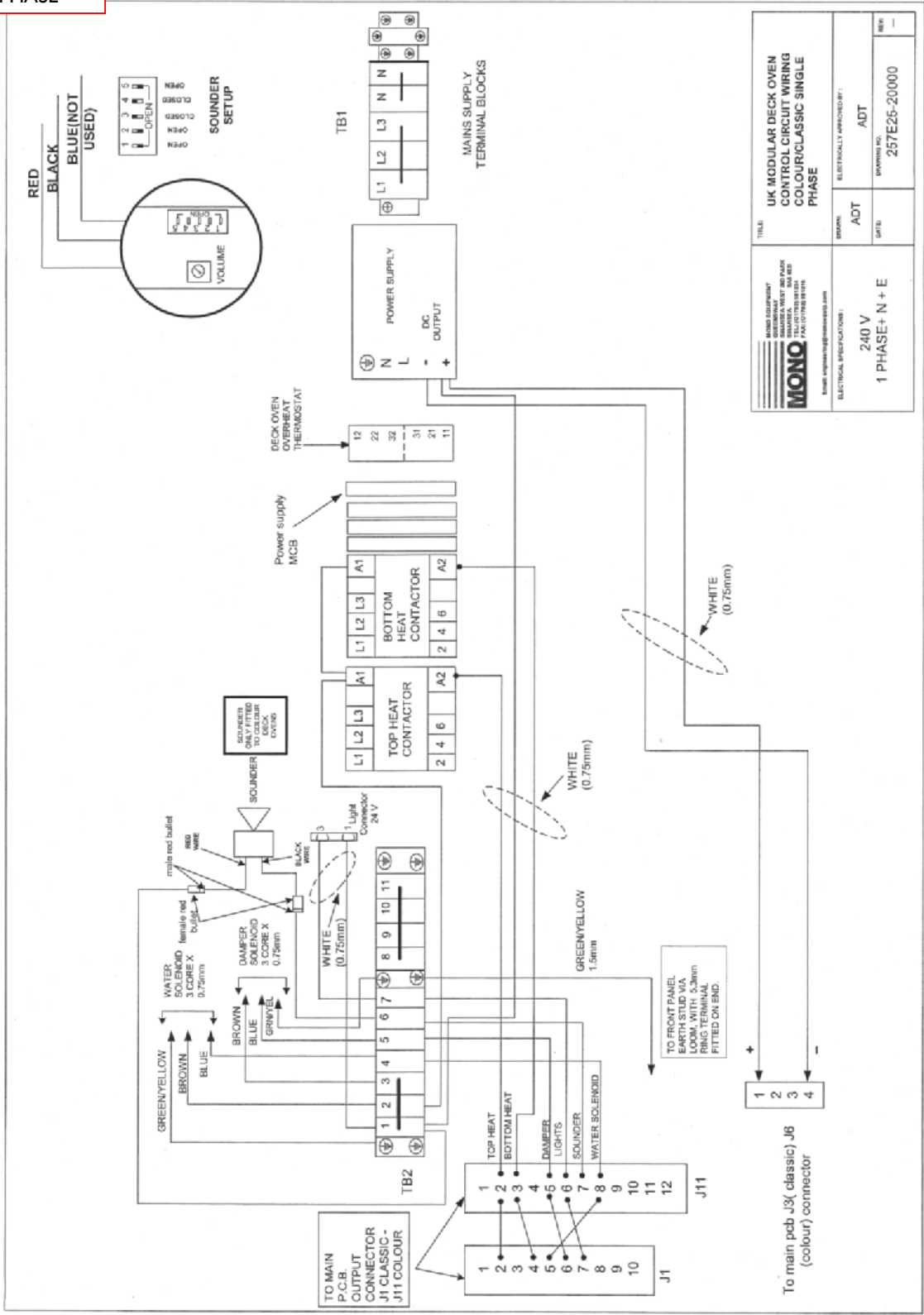

<p>MONO EQUIPMENT 100 MILLERS WAY HULL ROAD TULLOCH INDUSTRIAL ESTATE TULLOCH, DUMFRIES PA61 1YB SCOTLAND</p> <p>ELECTRICAL SPECIFICATIONS</p> <p>240 V 1 PHASE+ N + E</p>		<p>TITLE: UK MODULAR DECK OVEN CONTROL CIRCUIT WIRING COLOUR CLASSIC SINGLE PHASE</p> <p>DRAWN: ADT</p> <p>CHECKED: ADT</p> <p>DATE: 25/10/2019</p> <p>DRAWING NO: 257E25-20000</p> <p>REV: -</p>
--	--	---

I PHASE

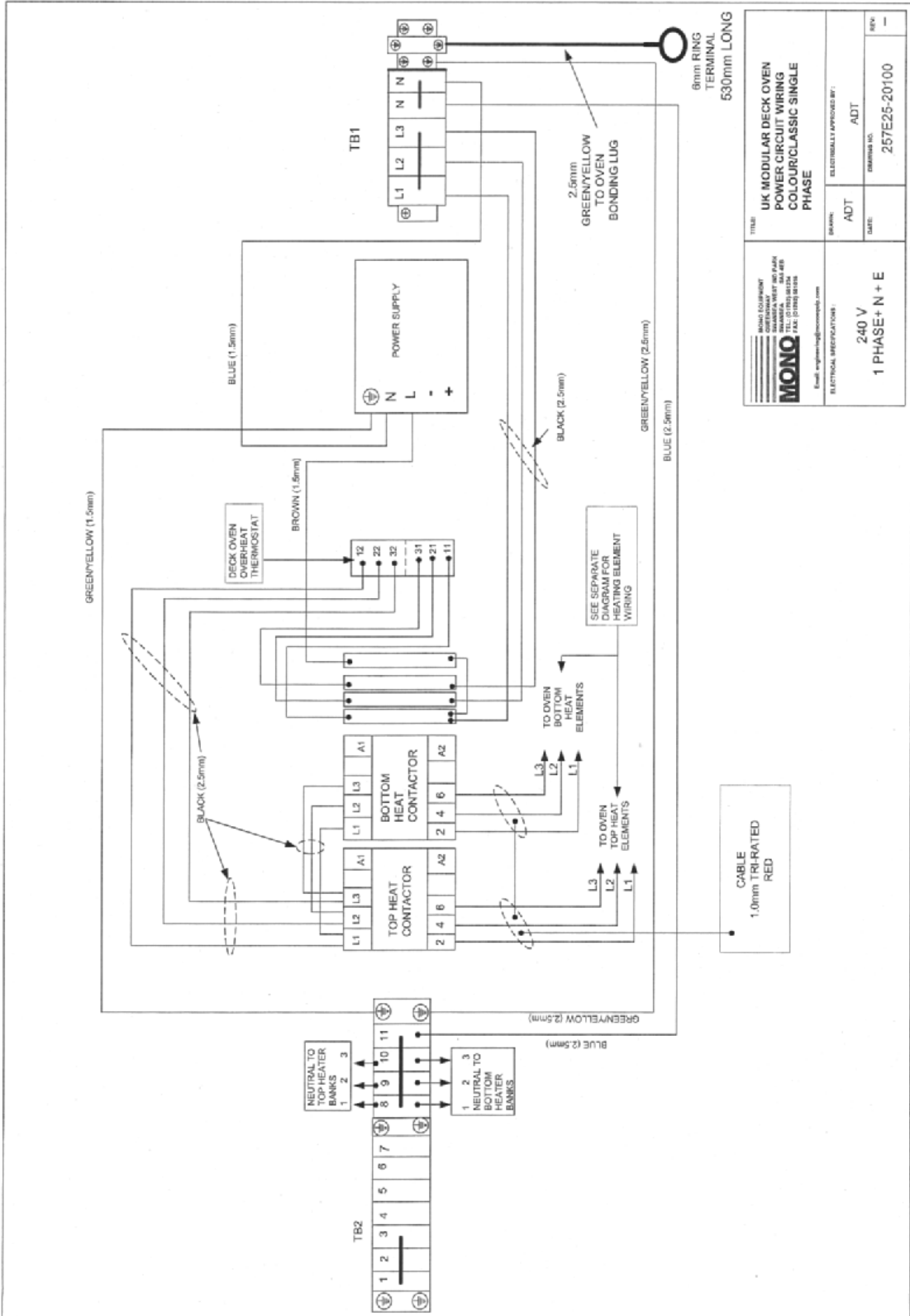

<p>MONO EQUIPMENT SHEWAN WATTS ELECTRICALS TEL: 01753 674466 FAX: 01753 674466 Email: support@shewanwatts.co.uk</p>	ELECTRICALLY APPROVED BY:	
	DATE:	DRAWING NO:
ELECTRICAL SPECIFICATIONS:		REV:
240 V 1 PHASE + N + E		257E25-20100
TITLE:		DATE:
UK MODULAR DECK OVEN POWER CIRCUIT WIRING COLOUR/CCLASSIC SINGLE PHASE		DRAWING NO:
SHEWAN WATTS ELECTRICALS		REV:

I PHASE

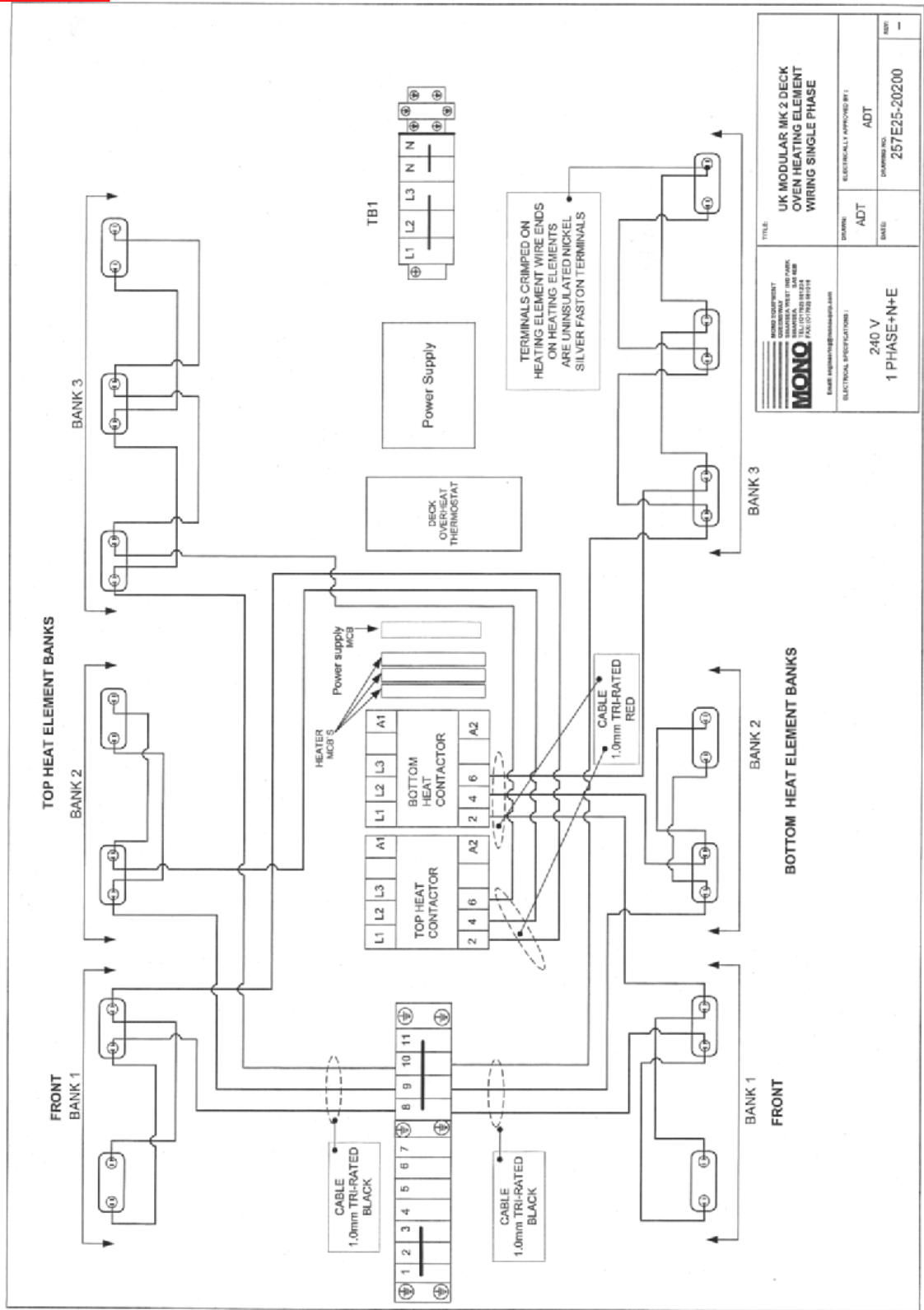

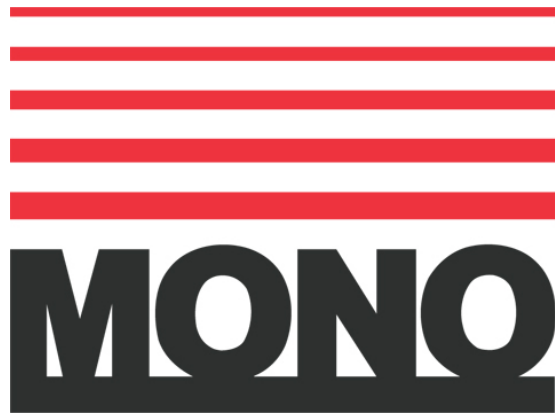

MONO Equipment
Queensway,
Swansea West Industrial Park,
Swansea,
SA5 4EB
UK

Tel. +44(0)1792 561234
Spares +44(0)1792 564039
Fax. +44(0)01792 561016
Email:mono@monoequip.com

www.monoequip.com

As it is our policy to improve our machines continuously, we reserve the right to change specifications without prior notice.

▪ **DISPOSAL**

Care should be taken when the machine comes to the end of its working life. All parts should be disposed of in the appropriate place, either recycling or other means as the law permits at the time.