



[www.monoequip.com](http://www.monoequip.com)

Enter **Serial No.** here. \_\_\_\_\_

In the event of an enquiry please quote this serial number.



## OPERATING AND MAINTENANCE MANUAL

# **FG177 PROVER CABINET**

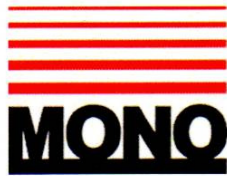

## DECLARATION OF CONFORMITY

We hereby declare that this machine complies with the essential health and safety requirements of :-

- The Machinery Directive 2006 / 42 / EC
- The Low voltage Directive 2014 / 35/ EC
- The requirements of the Electromagnetic Compatibility Directive 2004 / 108EC, 91 / 263 / EEC, 92 / 31 / EEC  
Incorporating standards  
EN55014-1:2006+A1:2009+A2:2011  
EN55014-2:1997+A1:2001+A2:2008
- The General Safety of Machinery and food processing Standards applicable
- Materials and Articles intended to come into contact with food Regulation (EC) No. 1935 / 2004

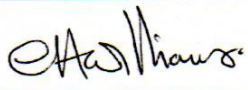
<b>Signed</b>	
G.A.Williams – Quality Manager	

<b>Date</b>	
-------------	--

<b>Machine FG Code.</b>		<b>Machine Serial No.</b>	
-----------------------------	--	-------------------------------	--

A technical construction file for this machine is retained at the following address:

**MONO EQUIPMENT**  
Queensway,  
Swansea West Industrial Park,  
Swansea  
SA5 4EB  
UK

**MONO EQUIPMENT** is a business name of **AFE GROUP Ltd**  
Registered in England No.3872673 VAT registration No.923428136

Registered office: Unit 9, Bryggen Road,  
North Lynn Industrial Estate,  
Kings Lynn,  
Norfolk,  
PE30 2HZ

# IMPORTANT NOTES

## ELECTRICAL SAFETY AND ADVICE REGARDING SUPPLEMENTARY ELECTRICAL PROTECTION:

Commercial bakeries, kitchens and foodservice areas are environments where electrical appliances may be located close to liquids or operate in and around damp conditions or where restricted movement for installation and service is evident.

The installation and periodic inspection of the appliance should only be undertaken by a qualified, skilled and competent electrician, and connected to the correct supply suitable for the load as stipulated by the appliance data label.

The electrical installation and connections should meet the necessary requirements of the local electrical wiring regulations and any electrical safety guidelines.

### We Recommend:

- Supplementary electrical protection with the use of a residual current device (RCD)
- Fixed wiring appliances incorporate a locally situated switch disconnecter to connect to, which is easily accessible for switching off and safe isolation purposes. The switch disconnecter must meet the specification requirements of IEC 60947.



The supply to this machine must be protected by a **30mA RCD**

## **SAFETY SYMBOLS**

The following safety symbols are used throughout this product documentation and manual (available at [www.monoequip.com](http://www.monoequip.com)).

Before using your new equipment, read the instruction manual carefully and pay special attention to information marked with the following symbols



### **WARNING**

Indicates a hazardous situation which, if not avoided, will result in death or serious injury.



### **WARNING**

Indicates a hazardous situation which, if not avoided, will result in electric shock.



### **CAUTION**

Indicates a hazardous situation which, if not avoided, will result in minor or moderate injury.

**Failure to adhere to the cleaning and maintenance instructions detailed in this booklet could affect the warranty of this machine.**

As it is our policy to improve our machines continuously, we reserve the right to change specifications without prior notice.

# **CONTENTS**

---

<b>Section - 1.0</b>	<b>Introduction</b>
<b>Section - 2.0</b>	<b>Overall Dimensions</b>
<b>Section - 3.0</b>	<b>Specifications</b>
<b>Section - 4.0</b>	<b>Safety</b>
<b>Section - 5.0</b>	<b>Installation</b>
<b>Section - 6.0</b>	<b>Isolation</b>
<b>Section - 7.0</b>	<b>Cleaning Instructions</b> <ul style="list-style-type: none"><li><input type="checkbox"/> Daily</li><li><input type="checkbox"/> Weekly</li></ul>
<b>Section - 8.0</b>	<b>Operating Conditions</b>
<b>Section - 9.0</b>	<b>Operating Instructions</b>
<b>Section - 10.0</b>	<b>Trouble shooting</b>
<b>Section - 11.0</b>	<b>Spares Information</b>
<b>Section - 12.0</b>	<b>Electrical Information</b>

# **1.0 INTRODUCTION**

---

This Mono prover forms part of a complete oven and prover combination.

It can be supplied as the stand of a bake off oven, making it space saving, or on its own as a free standing piece of equipment under a worktop etc.

It is thermostatically controlled and, with a manual water fill button, creates the atmosphere you require for your dough before baking.

Available in various tray sizes with either solid or glass doors.



**GLASS DOORS**



**SOLID DOORS**

## 2.0 OVERALL DIMENSIONS

---

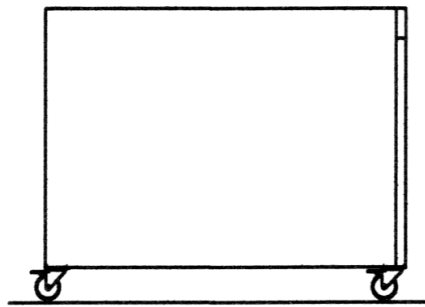
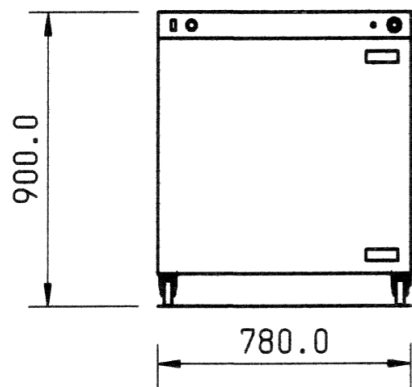

SINGLE DOOR

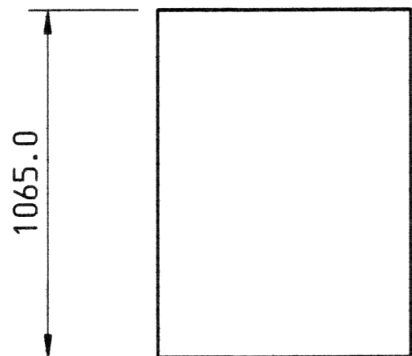

**HEIGHT:** 900mm  
**DEPTH:** 1065mm  
**WIDTH:** 780mm

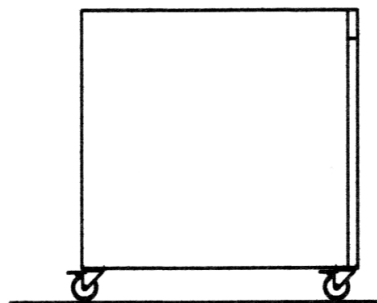
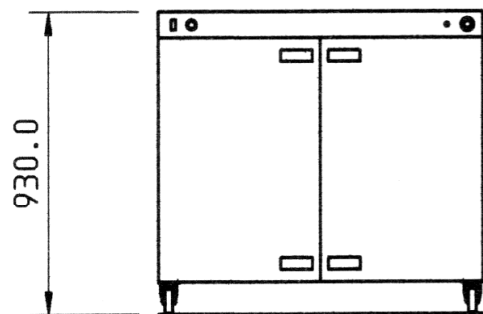

DOUBLE DOOR

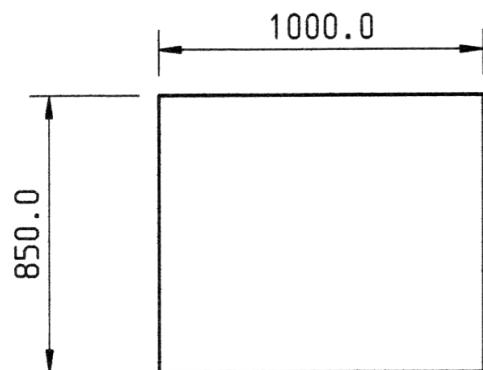

**HEIGHT:** 930mm  
**DEPTH:** 850mm  
**WIDTH:** 1000mm

## **3.0 SPECIFICATIONS**

---

**Capacity:** 8 to 10 trays depending on model

**Power:**



The supply to this machine must be protected by a **30mA RCD**

**Single element** = 230v, 1 ph, 50hz, 1kw, 4.5amps

**Double element** = 230v, 1 ph, 50hz, 2kw, 8.8amps

**Weight:**                      **Single element** = 80kg

**Double element** = 110kg

**Noise Level:**              Less than 85 dB.



As it is our policy to improve our machines continuously, we reserve the right to change specifications without prior notice.



## 4.0 SAFETY



**NOTE:  
BEFORE CLEANING OR REMOVING ANY PANEL FOR REPAIRS ETC..  
ISOLATE OVEN FROM MAINS SUPPLY AND ALLOW TO COOL**

- 1 Check cabinet for damage.
- 2 The prover **must** be sited on a flat, level floor.
-  3 When used with an oven on top, the oven must be correctly positioned.
- 4 Check the wheels are locked in position properly.
- 5 Ensure all panels are in place and fixed with bolts or screws.
- 6 The Bakery Manager or the Bakery Supervisor must carry out daily safety checks.
- 7 All repairs and maintenance of electrical units must only be carried out by authorised electricians.
-  8 All connections to the prover must be made in accordance with the statutory requirements of the country of installation.
- 9 It is the customer's responsibility to install and maintain an adequate water supply.

*Customers operating the prover in hard water areas must ensure that an efficient water treatment device protects the water supply to the prover.*

*--MONO is happy to advise on a suitable unit--*



- 10 While the prover is in operation, and for some time after use, it is inadvisable to touch the underside or lower surrounds because of conducted heat. Also ensure the floor area underneath is kept clear.

## **5.0 INSTALLATION**

---

- 1** The prover should always be positioned on **a flat, level floor**. This is essential for safety reasons and also to ensure the correct operation of the steaming reservoir.
  
- 2** The prover should be sited so that its door(s) can be opened to its full extent. This will enable the prover to be loaded and unloaded easily
  
- 3** In the interests of hygiene, we strongly recommend that you clean the inside and outside of your prover with hot water and approved mild detergent before using it for the first time.

*Although the utmost care is taken during assembly and pre-delivery inspection, there is always a possibility of residue settling in the prover.*

## **6.0 ISOLATION**

---

**To stop the prover in an emergency,  
switch off at the wall isolator.**

## **7.0 CLEANING INSTRUCTIONS**

---



**ISOLATE MACHINE FROM MAINS SUPPLY AND ALLOW TO COOL, BEFORE COMMENCING CLEANING**

### **Daily cleaning instructions**

- 1 Brush and scrape off any flour and dough adhering to the cabinet inner surfaces. Use only a stiff brush or plastic scraper.
- 2 Wash over handles and spot clean prover with a sterilising solution. Do not allow water to enter control panel switches.



**ISOLATE MACHINE FROM MAINS SUPPLY AND ALLOW TO COOL, BEFORE COMMENCING CLEANING**

### **Weekly cleaning instructions**

- 1 Follow daily cleaning instructions.
- 2 Remove the water tray in the bottom and clean the floor of the prover. Be careful not to bend the exposed element.
- 3 Replace the water tray carefully.
- 4 Regularly check the castors are free running and wash with soapy water to release the wheels if needed

## **8.0 OPERATING CONDITIONS**

---

- 1 The prover should always be positioned on a flat, level floor. This is essential for safety reasons and also to ensure that the steaming reservoir is safely and easily replenished with water.
  
- 2 The prover should be sited so that its door(s) can be opened to its full extent. This will enable the prover to be loaded and unloaded easily.
  
- 3 For best results ensure cleaning and operating instructions are followed meticulously.
  
- 4 It is the customer's responsibility to install and maintain an adequate water supply.

*Customers operating the prover in hard water areas must ensure that an efficient water treatment device protects the water supply to the prover.*

*--MONO is happy to advise on a suitable unit--*

# 9.0 OPERATING INSTRUCTIONS

## CONTROLS

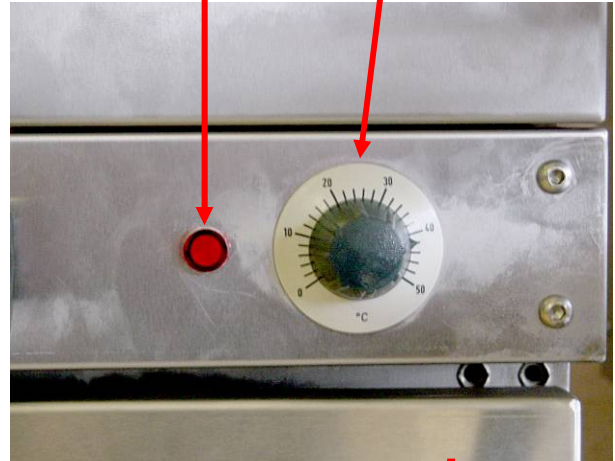
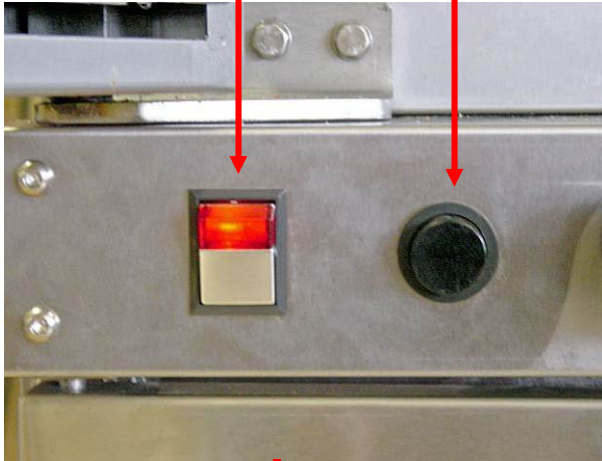
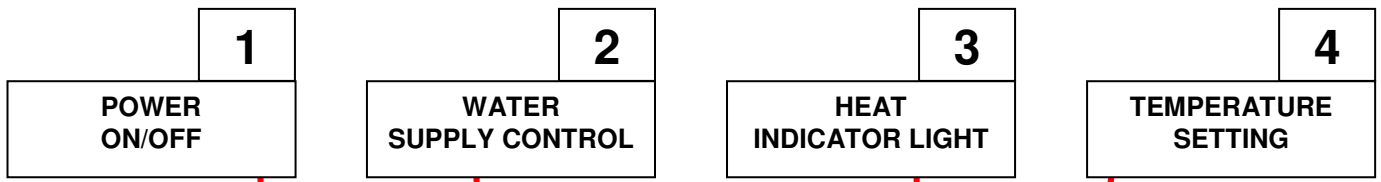

TIMER CONTROL  
(WHEN FITTED)



## OPERATION WITHOUT TIMER FITTED

1. Connect the water at the rear (washing machine type hose).  
Connect the power to a suitable socket.
2. Press power switch **(1)** to on position and open the door(s)
3. Press the water supply control button **(2)** and watch until the water level is about halfway up the sides of the water tray in the bottom.  
Release the button and close the door(s).
4. Turn the temperature-setting button **(4)** to the required temperature,  
*(Usually about 40 degrees).*  
The heat indicator light **(3)** will come on.
5. When the light goes out it means the prover is ready for use.  
*(Usually about 30minutes depending on the ambient temperature etc.)*
6. Check the water level every hour when the prover is in use and top up using water supply button **(2)** when required.

### **NOTE**

**IN ORDER TO MAINTAIN THE HUMIDITY LEVEL WITHIN THE CABINET, THE DOOR SHOULD BE ONLY OPENED BRIEFLY DURING USE.**

## OPERATION WITH TIMER FITTED

1. Connect the water at the rear (washing machine type hose).  
Connect the power to a suitable socket.
2. Press power switch **(1)** to on position and open the door(s)
3. Press the water supply control button **(2)** and watch until the water level is about halfway up the sides of the water tray in the bottom.  
Release the button and close the door(s).
4. Turn the temperature setting button **(4)** to the required temperature,  
*(usually about 40 degrees).*  
The heat indicator light **(3)** will come on.
5. When the light goes out it means the prover is ready for use.  
*(Usually about 30minutes depending on the ambient temperature etc.)*
6. Check the water level every hour when the prover is in use and top up using water supply button **(2)** when required.
7. If auto-switching mode is required then the operator must insure there is water in the tray before leaving the prover set.  
Set the timer to required settings as follows:

### **NOTE**

**IN ORDER TO MAINTAIN THE HUMIDITY LEVEL WITHIN THE CABINET.THE DOOR SHOULD BE ONLY OPENED BRIEFLY DURING USE.**



# TIMER SETTING

## Instruction Manual (GB)

### Time switch

#### Connection diagram



#### 1. Safety instructions

- ⚠ The installation and assembly of electrical equipment must be only carried out only by a skilled Person! Otherwise fire danger or danger of an electric shock exists!
- ⚠ Connect the supply voltage/frequency as stated on the product label!
- ⚠ Warranty void if housing opened by unauthorised person!
- ⚠ The electronic circuit is protected against a wide range of external influences. Incorrect operating may occur if external influences exceed certain limits!

#### 2. Initial operation

- The time switch is delivered in sleep-mode, the display is switched off.
- Press **OK**-button for 1 second.
- The current date and time is already programmed and European daylight savings time is activated.
- Select the desired language by pressing **↔**-buttons and confirm it by pressing **OK**. (Remark: By pressing **↔** you move one step backwards from the current position)
- If required, date, time and daylight savings time mode can be adjusted also by pressing **↔**-buttons and a subsequent confirmation with **OK**.

#### 3. Menu overview

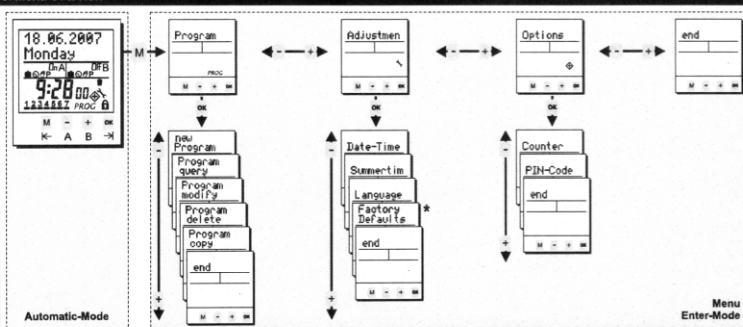

#### 4. Symbol legend

<b>On</b>	Channel is switched ON
<b>Off</b>	Channel is switched OFF
	For the current date the "holiday program" / "permanent by date" is activated
	Standard programming step
	Current state is based on a manual over-ride. The state will be cancelled with the next programming step.
<b>P</b>	Current state is based on a manual over-ride. The state is permanent until terminated manually (7).
	Days of the week Monday, Tuesday, ... Sunday; The underscores indicate if the program is active for the days above.
	Current state is based on a switching time with pulse function
	Element within sub-menu "program delete"
	The time switch is locked; to unlock the device the PIN has to be entered (12).

#### 5. Key function

- M** 1. To access the Enter-mode (program, adjustments, options) from the automatic-mode.  
2. To revert to the beginning of the current (sub-) menu.
- ↔** 1. To adjust the flashing digit.  
2. To scroll through a choice
- A/B** 1. Automatic-mode: To switch the channel ON or OFF until the next programming step occurs.  
2. Automatic-mode: A push longer than 3 sec. = Permanent switching status (7).
- OK** 1. To activate the time switch when operated without power supply.  
2. To confirm the selection or the entered data.

#### 6. Handling advice

- The time switch is programmable without external power supply after pressing the **OK**-button.
- To revert one step or one level back while in the Enter-Mode press **M**.
- After completion of a (sub-) menu confirming **end** will return the device into the automatic-mode.
- With **↔** the choice changes from **end** to **continue**. By confirming **continue** the time switch returns to the beginning of the current (sub-) menu.
- When confirming **end** before completion, the time switch returns to the automatic-mode without saving the entered data.

#### 7. Channel ON / OFF / Permanent P

- Channel ON / OFF**  
By pushing **A/B**-buttons (**↔**-buttons) a manual switch of the channels take place. The resulting switching status is marked with the hand-symbol and remains until the next programming step occurs. (temporary over-ride)  
**Permanent switching status P**  
By pressing the corresponding channel button **A/B** for more than 3 sec. the channel is permanently switched ON or OFF. The status remains until the next manual switching occurs (> 3 sec.). (permanent over-ride)

#### 8. New Program (See also the example (9))

Step A. to C. please refer to point 9. (Example "New Program")

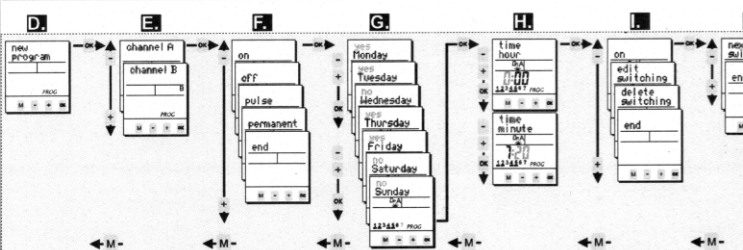

#### 9. Example „New Program“ (For a regular switching time)

- If power supply is disconnected press **OK** for one second. The display appears in Automatic-Mode.
- Press **M**, the time switch is now in the Enter-Mode.
- Confirm **Program** with **OK**.
- Confirm **new program** with **OK**.
- Choose the desired channel with **↔** and confirm with **OK**.
- For regular switching times choose **on** or **off** with **↔**-buttons and confirm with **OK**.
- Within this level you activate the days of the week (1...7) on which the switching time should happen. With **↔** you activate "yes" or deactivate "no" the corresponding date. Confirm each day with **OK**.
- Adjustment of the time: Hours **↔** and **OK** Minutes **↔** and **OK**.
- Verify the entered switching time: If the flashing summary of the programming step is correct, verify **on** or **off** with **OK**. After verification you have the choice between **edit/delete** and **end** with **↔**.
- If you want to proceed with programming, confirm **next switching** with **OK**. To leave the programming menu confirm **end**.

#### 10. Pulse

- Program** → **new program** → **channel A/B** → **↔**
- The pulse function provides you the opportunity of programming a switching time with a defined duration. As soon as the pulse-duration has expired the time switch switches OFF automatically (the duration of the pulse is up to 59:59 mm:ss). The programming is carried out like a standard switching time (see point 8 / 9) with following differences
- Choose **Pulse** function (9F).
  - Define the duration of the pulse (pulstime minute / pulstime second).
  - Program the days of the week
  - Program the switching time (time hour / time minute)
- Validation: Confirm the blinking summary of the pulse program

#### 11. Program permanent

- Program** → **new program** → **channel A/B** → **permanent** → ...
- One permanent by date programming step (holiday function) for each channel is possible. During the desired period (The function is valid for the whole days) the channel can be switched off (**permanent off**) or on (**permanent on**).
  - The programming of this function is as described in (8 / 9).
  - The choice **permanent** will not be offered anymore within the menu **new program** when already in use. The switching time can be modified and deleted within **Program modify** (13) and **Program delete** (12) respectively.

#### 12. Additional adjustments

Menu	Main menu	Application
<b>Program query</b>	<b>Program</b>	To query the programming steps and remaining memory locations
<b>Program copy</b>	<b>Program</b>	Copy from one channel to another. Memory of the channel won't be overwritten; the copied switching steps appear additionally. ⚠ Permanent by date function is not copied!
<b>Program delete</b>	<b>Program</b>	Deletion of switching time(s). The program for all channels, single channels and single programming steps within on channel can be deleted.
<b>Date-Time</b>	<b>Adjustment</b>	Adjustment of date and time
<b>Summertime</b>	<b>Adjustment</b>	Adjustment of the daylight saving time mode (ON/OFF)
<b>Language</b>	<b>Adjustment</b>	Choice of languages
<b>Factory Defaults*</b>	<b>Adjustment</b>	Reset to the state of delivery. ⚠ Date, time and switching program will be lost!
<b>Counter</b>	<b>Options</b>	Displays the hour counter and pulse counter for each channel and the time switch itself.
<b>PIN-Code</b>	<b>Options</b>	The time switch can be locked with a 4-digit PIN-Code. The code can be adjusted, activated and deactivated. If you have forgotten the Code please call customer service.
<b>Reset-Function</b>		Press all front keys for 2 seconds. The time switch is reset. The values for date and time will be deleted and have to be re-entered. The switching program has not been deleted!

#### 13. Program modify

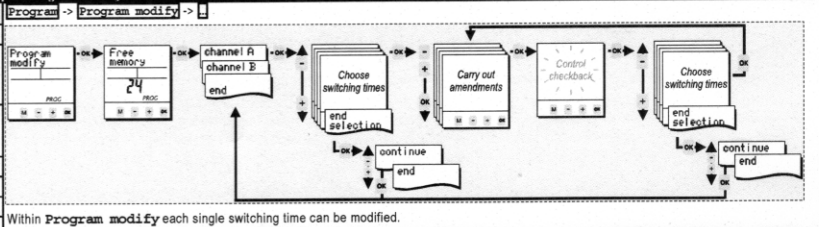

Within **Program modify** each single switching time can be modified.

#### 14. Data-key\*

- With a Data-key following activities are possible:
- **Save data**: Writes the data from the time switch into the memory of the Data-key.
  - **Program timeswitch**: Writes the data located inside the Key into the memory.
  - **Key function**: The time switch will solely apply programming steps from the Data-key. The switching program of the time switch is suppressed.
  - **Key readout**: To query the switching program of the Data-key.

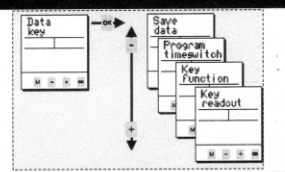

\*OPTIONAL

## **10.0 TROUBLESHOOTING**

---

### **1. Skinning.**

**Cause:**

Drying of products due to lack of humidity.

**Result:**

Pinched small products.

**Solution:**

- Is water connected?
  - Ensure door is firmly closed, during operation.
  - Do not allow product to stand in the bakery before loading the prover.
  - Control panel knob not operating
- 

### **2. Humidity (too high or too low)**

- Humidity will vary if door is opened frequently or the prover has not warmed up enough at the start of operation.
- Humidity will also vary according to the amount of product in the prover.

Please take account of these factors.

## OVERHEAT STAT RESET BUTTON



If the chamber heat thermostat fails, and the temperature goes above 75 deg C, the overheat stat will operate.

The cause should be investigated and corrected and then the overheat stat should be reset.

### TURN OFF THE POWER TO THE PROVER.

To reset the stat, the rear panel must be removed (4 screws).

Press the reset button and replace the back panel before turning the power back on.

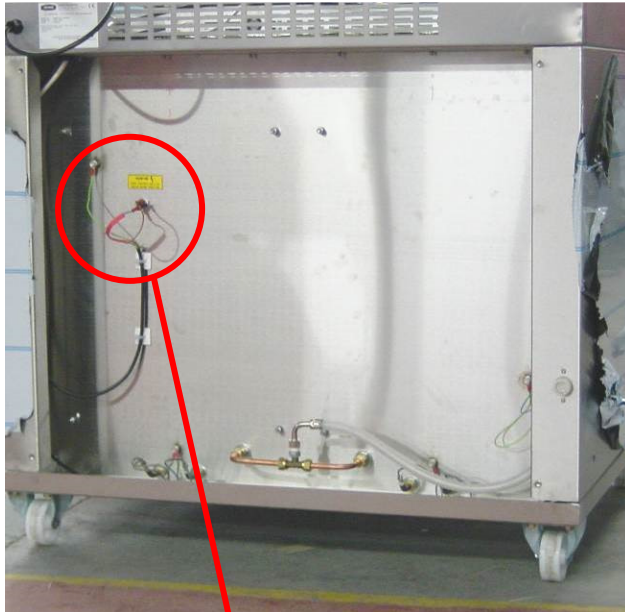

REAR VIEW WITH  
BACK SHEET REMOVED

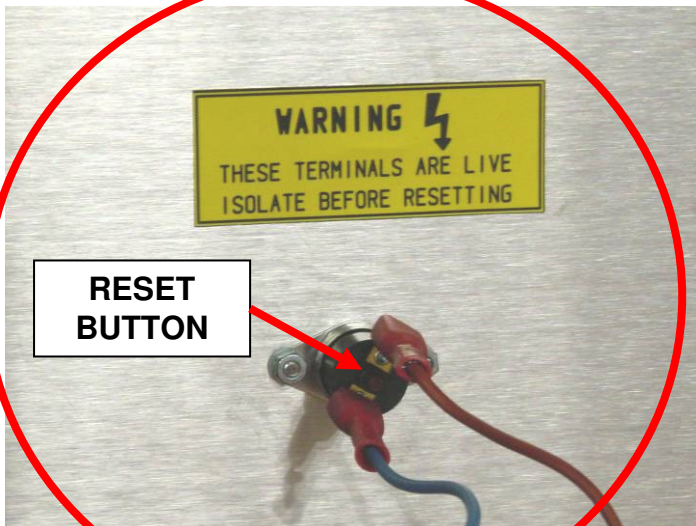

RESET  
BUTTON

RESET BUTTON POSITION

## **11.0 SPARES INFORMATION**

---

B842-07-001	ON/OFF SWITCH
B873-30-010	THERMOSTAT
B842-07-016 <i>B842-07-017</i>	WATER FILL SWITCH <i>BLACK CAP FOR SWITCH</i>
B994-83-001	WATER SOLENOID
B854-04-085	ELEMENT
B872-22-014	MCB
B842-43-001	HEAT ON INDICATOR
B842-34-010	7 DAY TIMER (IF FITTED)
B842-30-004	THERMAL SWITCH 70C

If a fault arises, please do not hesitate to contact the Customer Service Department, quoting the **machine serial number** on the silver information plate of the machine and on the front cover of this manual.

### **SPARES and OVERSEAS SUPPORT:**

**MONO**  
Queensway  
Swansea West Industrial Estate  
Swansea. SA5 4EB UK

email: [spares@monoequip.com](mailto:spares@monoequip.com)  
Web site: [www.monoequip.com](http://www.monoequip.com)

Tel. 01792 561234  
Fax. 01792 561016

# 12.0 ELECTRICAL INFORMATION

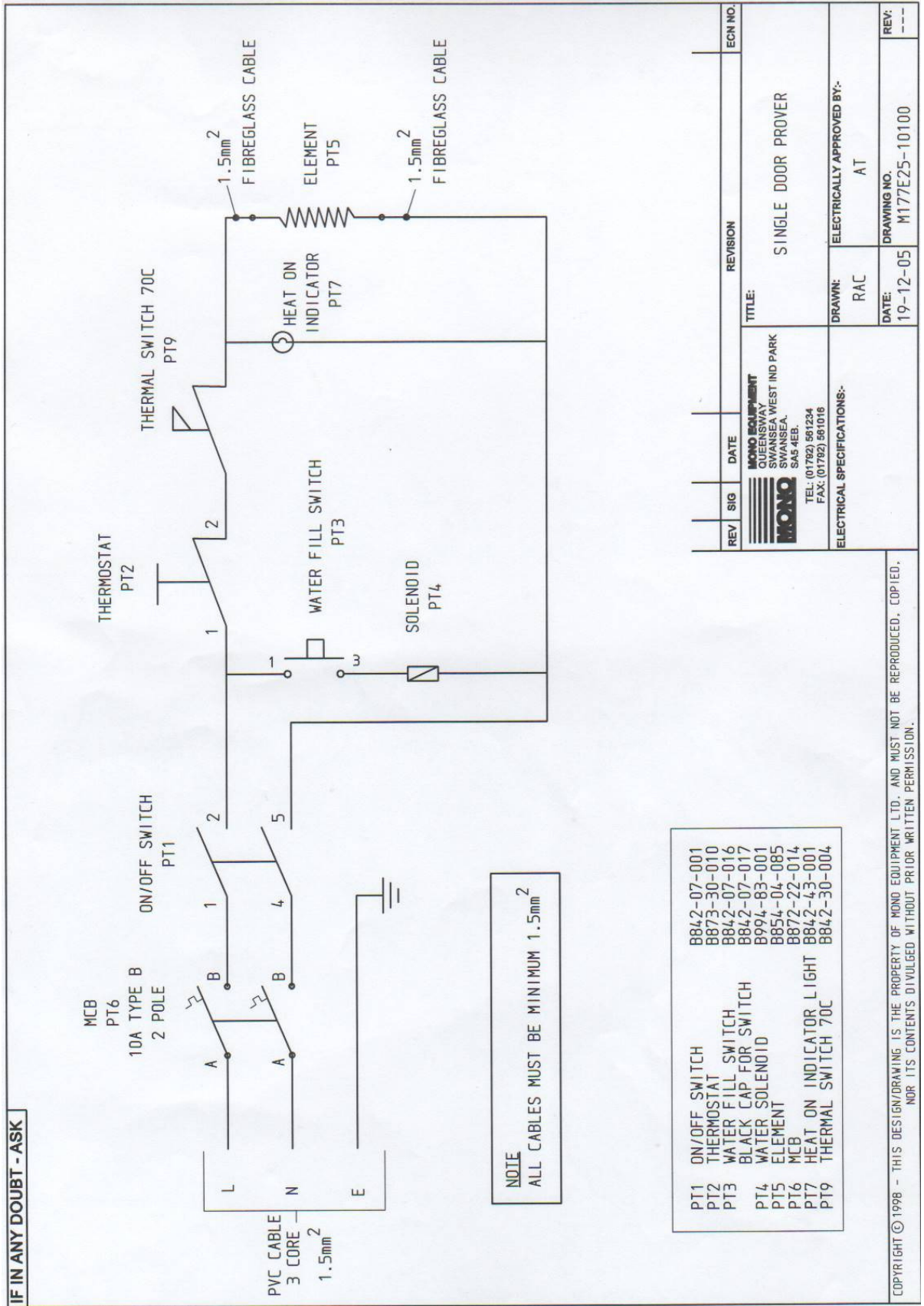

IF IN ANY DOUBT - ASK

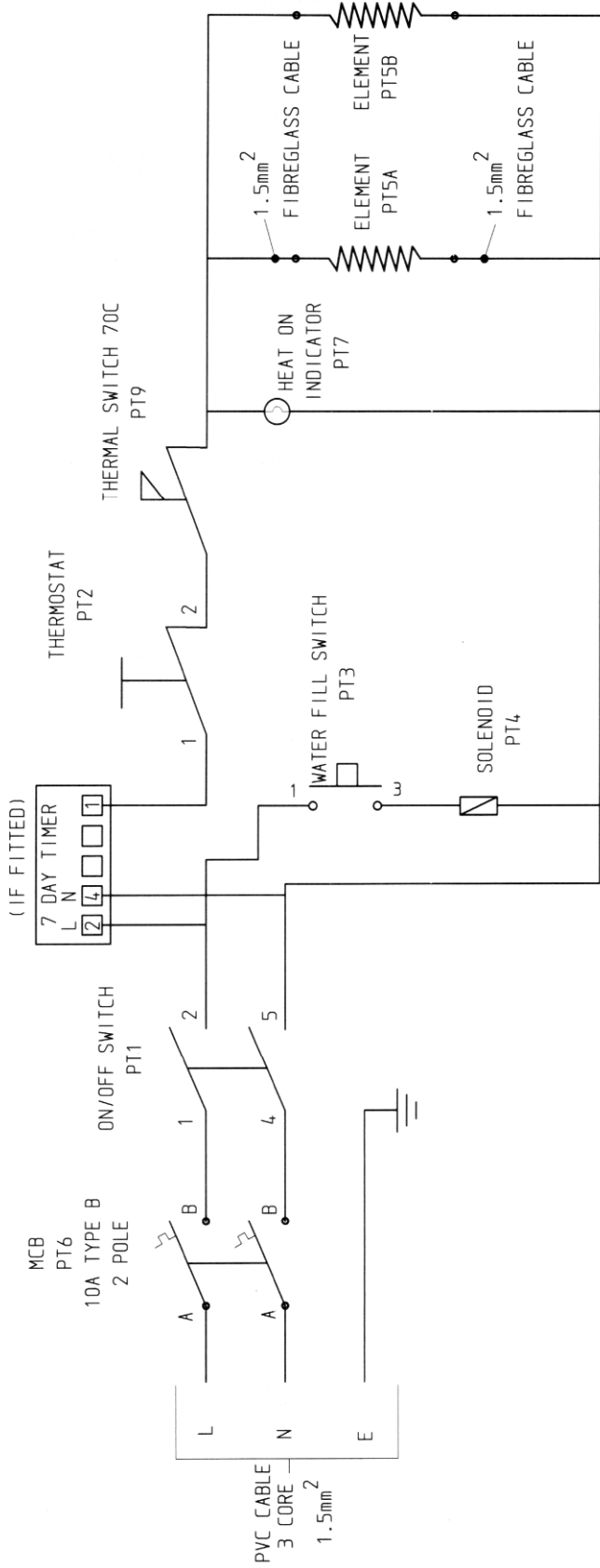

- PT1 ON/OFF SWITCH B842-07-001
- PT2 THERMOSTAT B873-30-010
- PT3 WATER FILL SWITCH B842-07-016
- PT4 BLACK CAP FOR SWITCH B842-07-017
- PT5 WATER SOLENOID B994-83-001
- PT6 ELEMENT B854-04-085
- PT7 MCB B872-22-014
- PT8 HEAT ON INDICATOR LIGHT B842-63-001
- PT9 THERMAL SWITCH 70C B842-34-010

REV	SIG	DATE	REVISION	ECN NO.
A	JC	19-5-09	PT 8 WAS B842-34-009.	124/09
<p><b>MONO EQUIPMENT</b> WILKINSON WEST IND PARK SWANSEA SA5 4EB. TEL: (01792) 561234 FAX: (01792) 561016</p>				
ELECTRICAL SPECIFICATIONS:-				
DRAWN: RAC				
ELECTRICALLY APPROVED BY:- AT				
DATE: 19-12-05				
DRAWING NO. M177E25-10000				
REV: A				

COPYRIGHT © 1998 - THIS DESIGN/DRAWING IS THE PROPERTY OF MONO EQUIPMENT LTD. AND MUST NOT BE REPRODUCED, COPIED, NOR ITS CONTENTS DIVULGED WITHOUT PRIOR WRITTEN PERMISSION.



## **MONO Equipment**

Queensway, Swansea West Industrial Park, Swansea, SA5 4EB UK

**Tel. 01792 561234**

Fax. 01792 561016

Email: [mono@monoequip.com](mailto:mono@monoequip.com)

**[www.monoequip.com](http://www.monoequip.com)**

As it is our policy to improve our machines continuously, we reserve the right to change specifications without prior notice.

### □ **DISPOSAL**

**CARE SHOULD BE TAKEN WHEN THE MACHINE COMES TO THE END OF ITS WORKING LIFE. ALL PARTS SHOULD BE DISPOSED OF IN THE APPROPRIATE PLACE, EITHER BY RECYCLING OR OTHER MEANS OF DISPOSAL THAT COMPLIES WITH LOCAL REGULATIONS.**

(IN UK, ENVIRONMENTAL PROTECTION ACT 1990 APPLIES)