

www.monoequip.com

Enter **Serial No.** here. _____

In the event of an enquiry please quote this serial number.



MXT ROTARY RACK OVEN

SET UP AND OPERATION OF OVEN

(With programming instructions)

GAS

ECOTOUCH CONTROL



DECLARATION OF CONFORMITY

We hereby declare that this machine complies with the essential health and safety requirements of :-

- The Machinery Directive 2006 / 42 / EC
- The Low voltage Directive 2014 / 35 / EU
- The requirements of the Electromagnetic Compatibility Directive EN 55014-1:2006 + A1:2009 + A2:2011
EN 55014-2:1997 + A1:2001 + A2:2008
- The General Safety of Machinery and food processing Standards applicable
- Materials and Articles intended to come into contact with food Regulation (EC) No. 1935 / 2004
- Tested in accordance with BSEN 203-1:2014, BESN203-2-2:2006 and BSEN 203-3:2009

Signed			
	G.A. Williams – Quality Manager		
Date			
Machine FG Code.		Machine Serial No.	

A technical construction file for this machine is retained at the following address:

MONO EQUIPMENT
Queensway,
Swansea West Industrial Park,
Swansea
SA5 4EB, UK

MONO EQUIPMENT is a business name of **AFE GROUP Ltd**
Registered in England No.3872673 VAT registration No.923428136

Registered office: Unit 9, Bryggen Road,
North Lynn Industrial Estate,
Kings Lynn,
Norfolk,
PE30 2HZ

SAFETY SYMBOLS

The following safety symbols are used throughout this product documentation. Before using your new equipment, read the instruction manual carefully and pay special attention to information marked with the following symbols.



WARNING

Indicates a hazardous situation which, if not avoided, will result in death or serious injury.



WARNING

Indicates a hazardous situation which, if not avoided, will result in electric shock.



CAUTION

Indicates a hazardous situation which, if not avoided, will result in minor or moderate injury.

ELECTRICAL SAFETY AND ADVICE REGARDING SUPPLEMENTARY ELECTRICAL PROTECTION

Commercial bakeries, kitchens and food service areas are environments where electrical appliances may be located close to liquids, or operate in and around damp conditions, or where restricted movement for installation and service is evident.

The installation and periodic inspection of the appliance should only be undertaken by a qualified, skilled and competent electrician, and connected to the correct supply suitable for the load as stipulated by the appliance data label.

The electrical installation and connections should meet the necessary requirements of the local electrical wiring regulations and any electrical safety guidelines.

We Recommend:

- Supplementary electrical protection with the use of a residual current device (RCD)
- Fixed wiring appliances incorporate a locally situated switch disconnector to connect to, which is easily accessible for switching off and safe isolation purposes. The switch disconnector must meet the specification requirements of IEC 60947.

Your attention is drawn to:

BS 7671:2018 – Guidance Note 8 – 8.13 : Other locations of increased risk

It is recognised that there may be locations of increased risk of electrical shock other than those specifically addressed in Part 7 of BS 7671. Examples of such locations could include laundries where there are washing and drying machines in close proximity, and water is present, and commercial kitchens with stainless steel units, where once again, water is present. Where, because of the perception of additional risks being likely, the installation designer decides that an installation or location warrants further protective measures, the options available includes:

- Automatic Disconnection of Supply (ADS) by means of a residual current device having a residual operating current not exceeding 30 mA;
- Supplementary protective equipotential bonding; and
- Reduction of maximum fault clearance time.

The provision of RCDs and supplementary bonding must be specified by the host organisation's appointed installation designer or electrical contractor and installed by a suitably qualified and competent electrician so as to comply with Regulations 419.2 and 544.2.



The supply to this machine must be protected by a **30mA RCD**

CONTENTS

	PAGE	
Section - 1	Introduction	8
Section - 2	Overall Dimensions	9
Section - 3	Specifications	10
Section - 4	Safety	14
Section - 5	Installation	16
Section - 6	Isolation	18
Section - 7	Cleaning Instructions	19
Section - 8	General Maintenance Instructions	20
Section - 9	Operation	20
	9- 1.0 baking using favourites	23
	9- 2.0 baking using manual menu	26
	9- 3.0 baking using programmes	29
	9- 4.0 creating a program	32
	9- 5.0 setting 7-day timer	38
	9- 6.0 settings	39
	9- 7.0 using usb port/stick	46
	9- 8.0 diagnostics	49
Section - 10	Troubleshooting	50
	Setting air slots	51
Section - 11	Spares and Services	52
Section - 12	Electrical information	53
Section - 13	Spares	61

Failure to adhere to the cleaning and maintenance instructions detailed in this booklet could affect the warranty of this machine.



NOTE

All reference to RIGHT HAND ovens means that main door is hinged on the right and the control panel is on the left.



RIGHT HAND

All reference to LEFT HAND ovens means that main door is hinged on the left and the control panel is on the left.

1.0 INTRODUCTION

The **MONO MXTG** rotary rack oven is a compact, gas fired oven with a computerized touch control panel. The oven is designed to accommodate a single rotating rack of up to eighteen trays capacity.

Ecotouch ovens are supplied with **TOUCH** displays for the user-friendly control panels. This can show pictures of product types or program numbers that have been set by the user. When not being used, the screen can show your company logo. A voice prompt facility is also available for the basic instructions like “Bake over”.

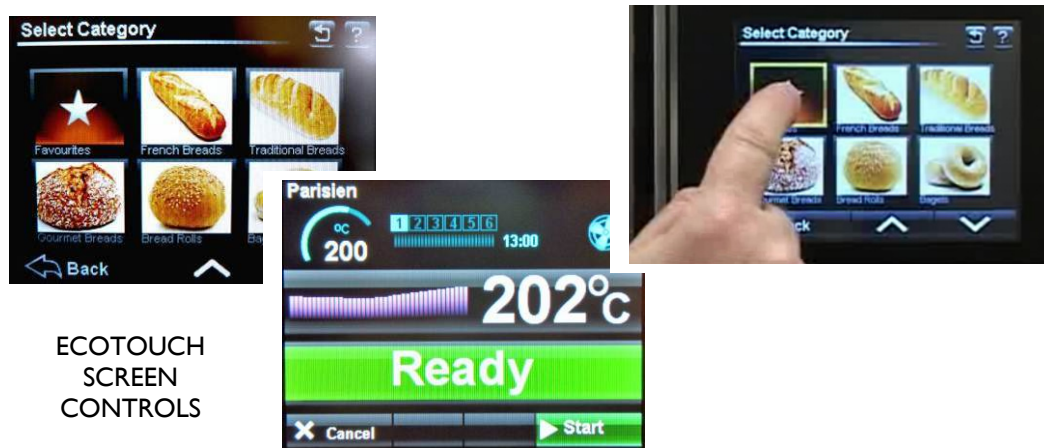

The oven is of stainless steel construction, with easily cleaned interior and exterior surfaces and smart appearance.

The fan and rack rotator have generously rated, totally enclosed, motors and a sealed for life gearbox.

The high-speed fan, heating and steam systems give efficient air circulation to produce a professional bake across a range of products via a diagonal cross-flow system with efficient air circulation.

The steam system is connected to a standard water supply. Steam is generated within the oven chamber by means of a multi-point, water injection cascade. The amount of steam to be generated is controlled by means of a programmable time period on the control panel. No drain is required for the baking and steaming process of this oven.

Programmed damper control is provided as part of the programming controls.

The oven door incorporates a large glass panel and LED lights to afford an excellent view of the baking progress. To optimise bakery layout the main oven door can be hinged on either side; even if oven is relocated after initial installation.

2.0 OVERALL DIMENSIONS

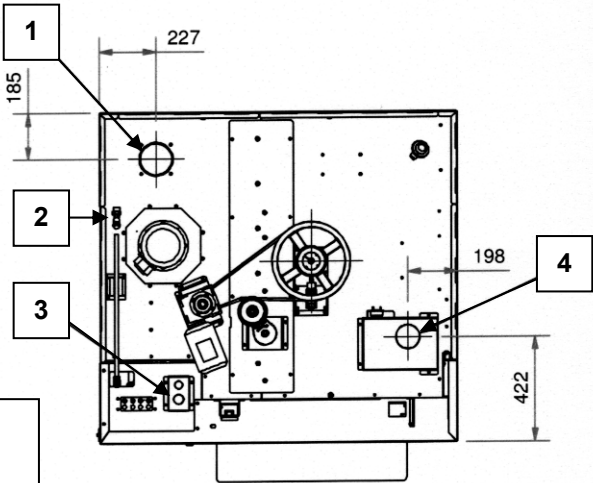
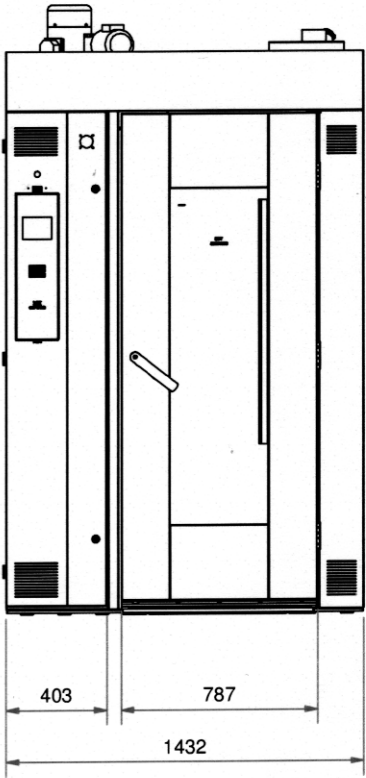
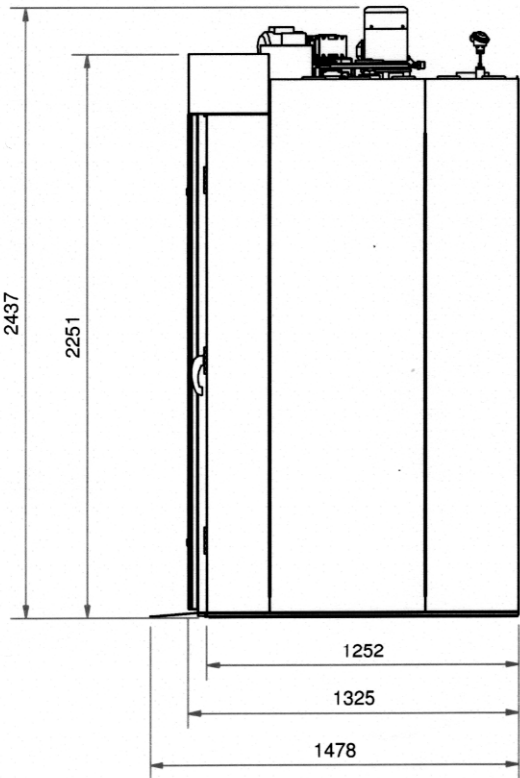

- 1. FLUE GAS CONNECTION 130mm DIA.
 - 2. WATER CONNECTION 3/4" BSP
 - 3. POWER CABLE INLET
 - 4. STEAM DIVERTER BOX CONNECTION 100mm DIA.
- MAX. RACK DIAGONAL = 885mm
 DOOR SWING RADIUS = 790mm

3.0 SPECIFICATIONS

Designation: Oven

Classification: Category I_{2H} Type B₂₃

Electrical

Power supply: 400Volt, 3 phase, E + N, 50Hz
1.9kW, 8 amps per phase.



The supply to this machine must be protected by a **30mA RCD**

Connection point: See section - *Dimensions*

Mechanical

Width/depth/height: See section - *Dimensions*

Maximum tray size: 762mm (30") x 457mm (18")

Air circulation: Radial fan driven by electric powered motor

Steam system: Mass energy storage, no drain

Rack rotation: Electric powered motor/gearbox driven via belt drive
Hanger inside baking chamber

No materials containing asbestos have used in the construction of this oven.

Gas system

Fuel: Natural gas (G20)

Operating pressure: 20mbar

Rated output, high: 50kW

Combustion air: 50m³/h (approx.)

Burner inlet connection: See section – *Dimensions*

Gas Connection

Ovens will be supplied with a 2 stage bespoke burner that will be set-up prior to dispatch. The burner is suitable for use with natural gas only.

The burner outputs at 50kW

Heat output	Gas pressure at connection point	Gas flow with burner in operation
50kW	20.0 mbar	5.16 m ³ /h



Note: Burner installation and start-up should be carried out by an authorized technician. Local regulations for gas installations must be followed. Do not use the burner with other gas types than indicated on the type plate. Repair and maintenance to be carried out by an authorized service engineer.

Flue gas connection

Connection on oven : Outside diameter 130mm dia

Draft Conditions: There must be a negative pressure of 1-5mm WG in the combustion chamber. If the pressure is higher than 0mm WG in service, a flue gas fan must be installed.

Temperature: The gas exhaust flue must be capable of withstanding a temperature of at least 400 deg C.

Heat output	Flue gas temperature	Flue gas quantity
50kW	400 deg C	150 m ³ /h

Note: None of the flue gas ducts should slope downwards or be horizontal (if no flue gas fan is installed). The slope must be upwards towards the chimney.

Avoid too many sharp elbows

Initial burning-off procedure

All ovens undergo the burn-off procedure in the factory before being dispatched.

Flue system

Flue connection: See section - *Dimensions*

Rack rotation

The rack hanger is driven by an electric motor situated on the mid left-hand side of the oven roof. Power transmission to the rack-hanger's central drive shaft is by means of a single tensioned V-belt that affords slippage of the transmission in the event of a blockage to rack rotation.

Air circulation system

An electrically powered radial fan re-circulates air within the oven. Heated air enters the fan at the upper left-hand side of the oven and is driven within the roof structure to the vertically orientated air door at the rear corner of the baking chamber. Adjustable openings in the air door allow the amount of air entering the baking chamber at various heights to be adjusted to get the optimum baking result.

The air door openings are set at the factory and should not require resetting. The factory settings are given in section – *Setting the Air Slots* for reference. Should these factory setting fail to give a satisfactory baking performance then instructions for adjusting the openings are given.

Steam system

The steam generating system is completely contained within the oven and situated at its left hand side in the lowermost region of the air duct, outside of the baking chamber. Only cold water, at a pressure of 2 bar (29 PSI) – 4 bar (58 PSI), needs to be connected to the oven for the purpose of steam generation, domestic pressure is usually within this parameter.

The pressure reducing valve on the oven is factory set at 1.5 bar (22 PSI).

From a cold oven start the steam system will typically require 30 minutes to accumulate sufficient energy to produce satisfactory steaming performance; and during repeated baking cycles it automatically re-energises itself during the bake cycle. No drain is required for the steam system.

Under normal conditions of use this oven is not considered a pressure vessel.

Gas Heating System

The gas heating system consists of the gas supply pipework, a pre-mix burner, air-to-air heat exchanger and flue outlet.

The gas burner is factory-fitted and must be connected to a natural gas fuel supply only. Every burner is pre-set and no adjustment should be attempted. Gas is mixed with air supplied from the room the appliance is situated in and burned to produce hot gaseous products of combustion that flow through the internal passages of the heat exchanger and are kept separated from the oven's re-circulating air.

Heat is transferred to the baking chamber through the interaction of re-circulating air passing over the hot surfaces of the heat exchanger.

After passing through the heat exchanger the products of combustion discharge from the oven through the flue outlet terminating at roof level towards the rear left side of the oven. This oven is intended to be connected to a flue in accordance with the specification and local authority guidelines.

Electrical connection

The oven is fitted with built-in automatic fuses, situated in the uppermost region of the compartment behind the control door. The fuses are marked and can be accessed when the control door is opened.

Ventilation

To ensure the correct operation of the roof-mounted components the ambient temperature should not exceed 50°C. The oven requires zero clearance on left, right and rear vertical faces for operation or maintenance.

Extraction

Airborne emissions from the baking process, such as steam, oil, etc., will be discharged from the overpressure duct and the damper duct; both situated at roof level towards the front of the oven. Discharge will also occur from the front of the oven upon opening the door at the end of a bake.

See also section – *Installation*.



Noise

Emission of airborne noise is less than 70dB

4.0 SAFETY



***In the interest of safety and efficient operation of the oven, it is essential that this manual should be made available to the operator before work is commenced.
The following points should be observed and followed at all times.***

- 1 This oven is designed for baking bread, confectionery and savoury bakery products. Do not use it for other items without consulting with **MONO**.
- 2 This appliance is not intended for outdoor use.
- 3 This appliance is not intended for residential use.
- 4 It is essential for proper and safe operation of the oven that users are familiar with its operation and use.
Read the instructions provided in this document before use.
- 5  **EVERY OVEN INSTALLATION MUST BE APPROVED BY THE LOCAL AUTHORITY**
Neither the manufacturer, nor the vendors are liable in respect of accidents or damage where the purchaser/installer has not obtained such approval.
- 6 Connection of the oven to the local gas supply is the responsibility of the installer, who should be a “Gas Safe” registered engineer using components that conform to the current industry standards.
- 7 It is the responsibility of the installer to ensure that an adequate supply of combustion air to the oven (see *Specifications* section for details) and the evacuation of combustion products are permanently in place.
- 8 An emergency isolation valve must be fitted in the gas supply and be well marked and accessible to operators.
- 9 No change is permitted to the gas group or family from that which is specified for this oven.
- 10 Parts of the oven that are protected by paint are not to be adjusted.
Do not adjust these parts.
- 11 Unauthorised service or repairs to these ovens may cause personal injury or damage to the equipment, which may invalidate warranty agreements.
- 12 Only qualified engineers appointed by MONO EQUIPMENT should carry out service and repairs to this equipment.
- 13  Electrical panels and electrical distributor boxes should not be opened until the main supply to the oven has been turned off.
- 14 When choosing and installing a flue, the precautions and instructions in this manual must be observed.

15 All connections to this oven must be made in accordance with the statutory and technical regulations of the country in which the oven is installed.



16 When work is being carried out inside the oven, the electrical mains isolator must be turned off and locked.



17 Whenever there is someone working inside the oven, the baking compartment door should be wedged open and a suitable warning notice hung on the door to prevent it being accidentally closed.



18 While the oven is in operation, and for some time after having been in operation, it is dangerous to touch the window glass or the metal surfaces in its vicinity. The oven must be allowed to cool before any form of cleaning is started.

19 Use only **MONO** spare parts for this oven.

20 The construction of the oven must not be changed.

21 Customers operating this oven in a hard water area must ensure that an efficient water-softening device protects the water supply to the equipment.

22 Oven gloves should be worn when moving products in or out of the oven.

23 The owner of the oven is **legally obliged to instruct staff** using the oven in its operation and in these safety regulations. The instruction manual for the oven must not be removed from the oven work area.



WARNING: WHEN DOING ANY MAINTENANCE ON TOP, KEEP CLEAR OF THE RECTANGULAR FLUE PIPE TOWARDS THE FRONT RIGHT HAND SIDE OF THE ROOF. VERY HOT AIR IS EJECTED.

24 Moving parts remain unguarded on the oven roof as this area is out of reach of the operator and therefore deemed safe. Care must be taken to avoid these motorised parts when maintenance tasks are performed.

25 Unless trays/containers for the purpose of holding the oven products are supplied with the oven by the manufacturer, it is the responsibility of the customer to ensure that the nature and surface conditions of materials likely to come into contact with food shall be such that they cannot contaminate or spoil the food.

26 This appliance is only for professional use and must be used by qualified people.

27 Up until August 2017 the oven's main door has a safety release foot-plate on its inner side allowing the door to be opened from inside in an emergency lock-in situation.

EMERGENCY INTERNAL-DOOR RELEASE

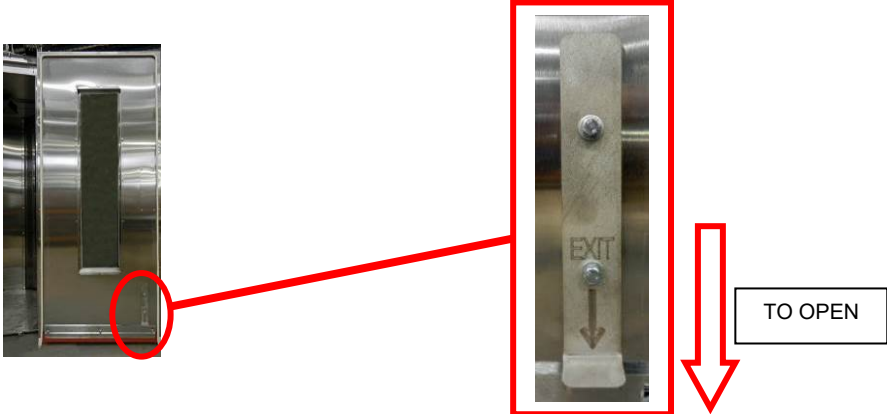

After August 2017 the oven's main door has a safety release handle on its inner side allowing the door to be opened from inside in an emergency lock-in situation.

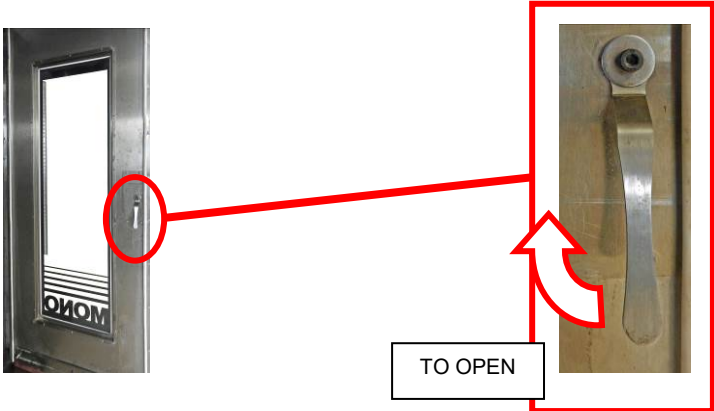

5.0 INSTALLATION

- 1 The **MONO MXTg** oven is designed to operate as a freestanding unit, and must not be bolted down or fixed to the floor in any way.
- 2 The concrete floor beneath the oven must be smooth, flat and clear of any obstructions, and must be at least 150mm (6") thick.
- 3 The foundation must be flush with the overall bakery floor because racks are wheeled up a ramp (supplied with the oven) into the baking chamber.
- 4 A minimum headroom clearance of 3 metres (180") between the floor and the bakery ceiling must be maintained at all times. A minimum clearance of 100mm (4") is to be maintained between bakery walls and oven rear and sides.
Ovens may be installed next to each other without clearance between them.

5 WATER SUPPLY

The water supply to the oven shall be fitted with protective means against backflow in the water supply and installed according to the national regulations in force. Minimum pressure should be 2 bar - 4bar.

Domestic pressure is usually within this parameter.

Customers in hard water areas must ensure that an efficient water treatment device protects the supply to the oven. It is the customers' responsibility to install and maintain an adequate water supply to the oven, which should comply with local water regulations.

Connect to a suitable water supply, making sure that the pipes are flushed out to remove all foreign bodies i.e. flux or solder.

NOTE

Set up of the pressure regulator should not be required as it is factory set to the optimum setting 1.5 bar to provide the best steam during a bake.

- 6 Pipework from the gas supply to the oven shall be arranged so as to not require removal of the burner for routine maintenance tasks.
- 7 Parts of the oven that are protected by paint are not to be adjusted.
Do not adjust these parts.
- 8 Pipework connections shall be achieved either by threaded joints conforming to EN10226-1 (taper-parallel threads) or EN10226-2 (taper-taper threads), each sealed with compound or tape suitable for the gas specified for this oven, or by compression fittings.

OVEN EVACUATION

It is recommended that evacuation of the oven baking chamber products is achieved with a hood covering the entire oven top and projecting beyond the front of the oven by 600mm. the extraction rate from the hood should be approximately 1700m³/h.

The oven is a Type B appliance requiring an 8" flue to evacuate the products of combustion to the outside of the room containing the oven and the combustion air to be drawn from that room.

The customer is responsible for providing adequate levels of make-up air.

GAS CONNECTION

Ovens will be supplied with a bespoke burner that will be set-up prior to dispatch. The burner is suitable for use with natural gas only.

The burner output is 50kW.

Heat output	Gas pressure at connection point	Gas flow with burner in operation
50kW	20.0 mbar	5.16 m ³ /h

Note: Burner installation and start-up should be carried out by an authorized technician. Local regulations for gas installations must be followed.

Do not use the burner with other gas types than indicated on the type plate.

Repair and maintenance to be carried out by an authorized service engineer.

Burner reset

The burner reset button is located above the control panel. After 3 failed attempts of igniting, the button will illuminate signalling that the burner has locked out.

To reset, press the button until the light goes out.

The burner will then attempt to ignite 3 more times.

If the burner continuously fails, contact a qualified gas engineer.

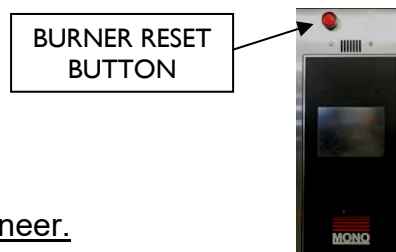

FLUE GAS CONNECTION

Connection on oven : Outside diameter 130mm dia

Draft Conditions: There must be a negative pressure of 1-5mm WG in the combustion chamber. If the pressure is higher than 0mm WG in service, a flue gas fan must be installed.

Temperature: The gas exhaust flue must be capable of withstanding a temperature of at least 400 deg C.

Heat output	Flue gas temperature	Flue gas quantity
50kW	400 deg C	150 m ³ /h

Note: None of the flue gas ducts should slope downwards or be horizontal (if no flue gas fan is installed). The slope must be upwards towards the chimney. Avoid too many sharp elbows

INITIAL BURNING-OFF PROCEDURE

All ovens undergo a burn-off procedure in the factory before being dispatched.

6.0 ISOLATION

In case of an emergency, switch oven off at the mains electrical isolator switch and gas mains tap.

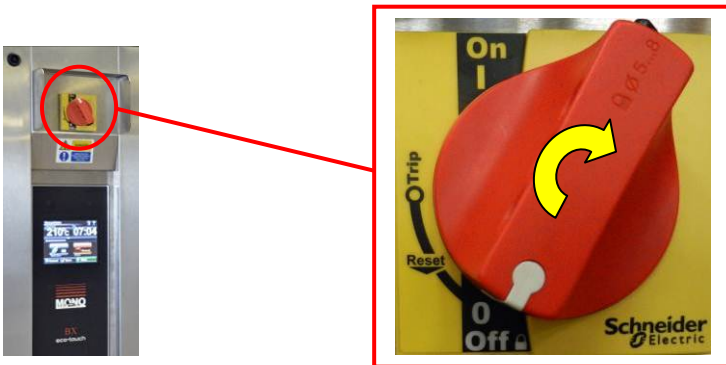

**MAINS ELECTRICAL
ISOLATOR SWITCH**
On main control door.



NOTE:

AS SOME PARTS STAY ELECTRICALLY LIVE AFTER THE ISOLATOR SWITCH ABOVE IS OPERATED, ENSURE THE OVEN IS DISCONNECTED FROM THE CONSUMER POWER SUPPLY (MAINS) IF WORKING ON THE ELECTRICAL BOX AND PANEL.



**TYPICAL GAS
ISOLATING VALVE**
Installed near oven.

7.0 CLEANING INSTRUCTIONS ---

Caution

Do not use high-pressure equipment to clean the oven.

The oven has been designed with sealed components, which are used wherever possible. The minimum of routine cleaning is required, but it is essential that it be properly and regularly carried out.

1. Sweep out debris from the oven floor daily.
2. Clean up spillages of product on the oven floor.
3. Wipe off splashes on door window.

Do not use alkaline or abrasive detergents when cleaning the oven.
Do not use detergents on the control panel overlay – wipe with a damp cloth only.

Note: *Buildup of spillages may result caused by incorrectly placed racks. Also check for damage to door seals, particularly if operators are careless with rack handling.*

GAS BURNER

For cleaning, service and maintenance of the burner please contact an authorised expert company.

8.0 GENERAL MAINTENANCE ---

To maintain the warranty conditions, the oven must undergo service at specific intervals. Below is the service program with the given intervals:

Every 3 months

Lubrication:

Door lock

Heat resistant grease

Every 12 months

Check/adjust:

Door lock mechanism

Internal door release mechanism

Lighting, including cables

Damper function

Drive belt tension

Limit positions

Water connection tightness

Solenoid valve operation

Rack hanger bearing

Function check

Chamber temperature calibration

Gas heated oven:

Servicing of the gas burner, heat exchanger and flue should be carried out at least once every 12 months by a suitably qualified person.

Lighting

If the lighting in the door fails to operate, contact the Mono service dept. It cannot be replaced by the user.



Section 9

TOUCH SCREEN OPERATING INSTRUCTIONS

BASIC OPERATION

ALL OPERATIONS ARE ACTIVATED BY TOUCHING AREAS ON THE SCREEN, WHICH WILL PASS YOU ON TO THE NEXT INFORMATION PANEL.

DO NOT USE EXCESSIVE FORCE.

(THE PRESSURE REQUIRED TO OPERATE THE PANEL CAN BE ALTERED IN THE SETTINGS SECTION)



STANDBY
THE OVEN TURNS OFF.
TOUCH THE SCREEN TO GO TO
THE OPTION SCREEN.

SLEEP
THE OVEN STAYS AT 100c AND
HEATS TO LAST PROGRAM
TEMPERATURE WHEN THE
SCREEN IS TOUCHED.
OPTION SCREEN THEN SHOWS.

9 -1 BAKING USING FAVOURITES MENU

TOUCH TO OPEN THE FAVOURITES SELECT SCREEN

1



OPTION SCREEN

TOUCH THE NAME OF THE PRODUCT REQUIRED

2



SELECT SCREEN

TOUCH THE "FULL LOAD" OR "HALF LOAD" AS REQUIRED

3

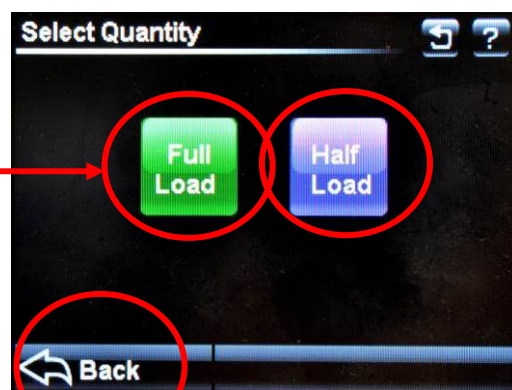

LOAD SCREEN

TO RETURN TO THE PREVIOUS SCREEN TOUCH THE "BACK" BUTTON AT ANY TIME

IF THE OVEN IS NOT UP TO TEMPERATURE IT WILL SHOW THE HEATING SCREEN.

WAIT FOR THE OVEN TO REACH TEMPERATURE

IF THE OVEN IS TOO HOT FOR THE TEMPERATURE CHOSEN, THE SCREEN WILL TELL YOU TO OPEN THE DOOR TO AID COOLING.

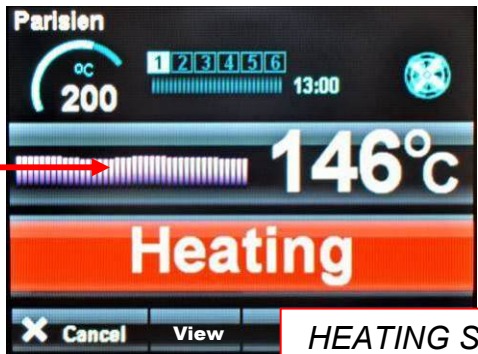

HEATING SCREEN

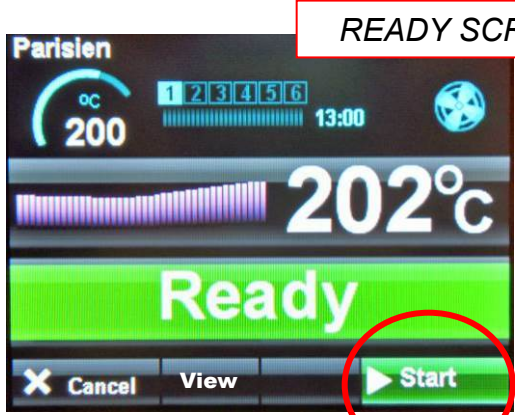

READY SCREEN

WHEN OVEN IS AT THE CORRECT TEMPERATURE THE "READY" SCREEN WILL SHOW.

1. OPEN DOOR AND LOAD PRODUCT.
2. CLOSE THE DOOR FULLY.
3. TOUCH "START"

TIP
TO HELP TO KEEP THE OVEN HOT, TRY NOT TO KEEP THE DOOR OPEN MORE THAN NEEDED

4



BAKE IN PROGRESS SCREEN

THIS SCREEN WILL SHOW WHILE THE PRODUCT IS BAKING

BAKE PHASE (WHEN USED)

ACTUAL OVEN TEMPERATURE

SET TEMPERATURE

TEMPERATURE PROFILE BAR

BAKE TIME PROGRESS BAR



BAKE TIME LEFT

NOTE
The actual temperature shown will rise and fall above and below the set temperature as the oven cools and reheats. This is not a fault

BAKE OVER SCREEN



5

AT THE END OF THE BAKE TIME A SOUNDER WILL BE HEARD AND "BAKE OVER" WILL FLASH. TOUCH "**STOP**" AND OPEN THE DOOR TO REMOVE THE PRODUCT.

TO KEEP THE OVEN BAKING FOR EXTRA MINUTES THE "+ 10 MIN" BUTTON CAN BE TOUCHED. (THIS TIME CAN BE ALTERED IN SET UP)

TOUCHING "VIEW" BUTTON DURING A BAKE



TOUCHING "**VIEW**" BUTTON DURING A BAKE WILL SHOW THE SETTINGS FOR THE BAKE IN PROGRESS. TOUCH "**CANCEL**" TO GO BACK TO THE PREVIOUS SCREEN.

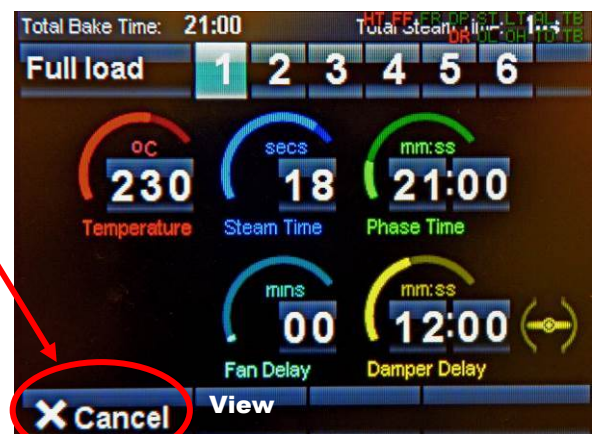

VIEW SCREEN

9 - 2 BAKING USING MANUAL MENU

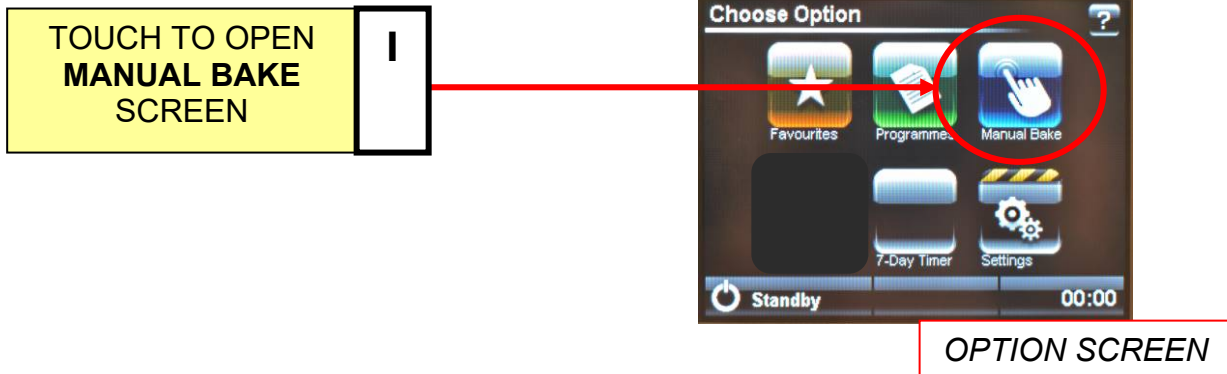

SET BAKE TIME AND TEMPERATURE

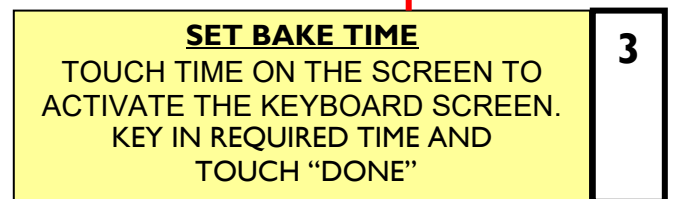
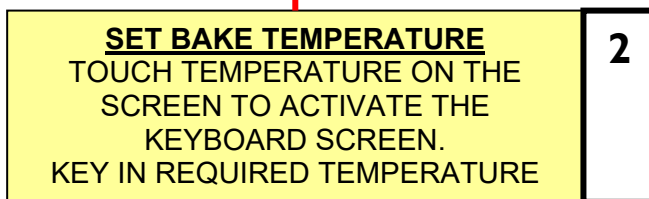
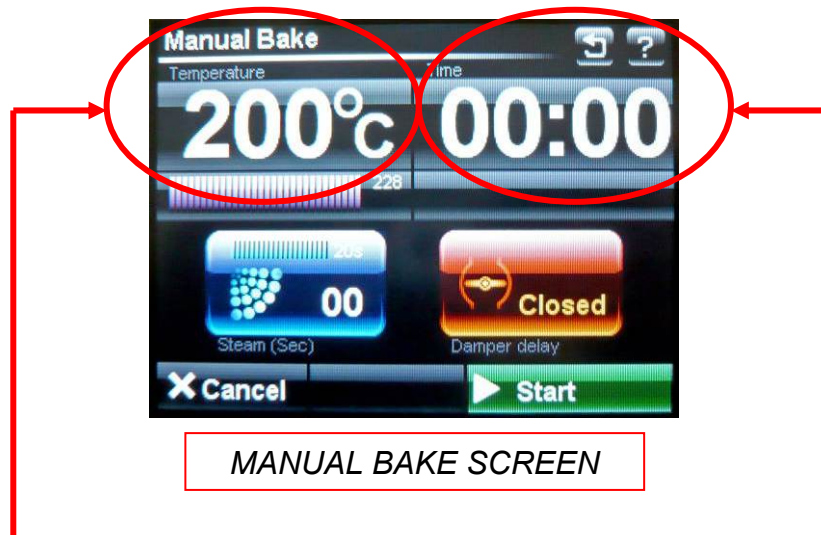

NOTE:

TIME DOES NOT HAVE TO BE SET IN MANUAL MODE. (ONLY TEMPERATURE)
WHEN START IS PRESSED, THE TIME WILL COUNT UP INSTEAD OF DOWN.
TOUCH STOP TO FINISH THE BAKE.

USE STEAM TIME AND DAMPER IF REQUIRED

STEAM
 TOUCH AND HOLD FOR THE TIME (SECONDS) STEAM IS REQUIRED. (THIS CAN BE USED BEFORE OR DURING THE BAKE)

DAMPER
 TOUCH TO OPEN THE DAMPER. (SYMBOL IS GREEN)
 TOUCH TO CLOSE THE DAMPER. (SYMBOL IS RED)



CANCEL
 TOUCH AT ANYTIME TO GO BACK TO THE SETTING SCREEN.

MANUAL BAKE SCREEN 2

START
 TOUCH "START" TO START BAKE



TOUCH "STOP" WHEN END OF BAKE BUZZER SOUNDS OR WHEN REQUIRED IF NO TIME WAS ENTERED

SAVE MANUAL PROGRAM, IF REQUIRED



MANUAL BAKE SCREEN 3

SAVE SETTINGS

IF NO TIME WAS ENTERED AT THE START OF THE BAKE, WHEN STOP IS TOUCHED "SAVE" WILL APPEAR AT THE BOTTOM OF THE SCREEN. "SAVE" CAN BE TOUCHED AND AN OPTION SCREEN WILL APPEAR.

7

TOUCH "ADD TO FAVOURITES"
OR "SAVE AS"

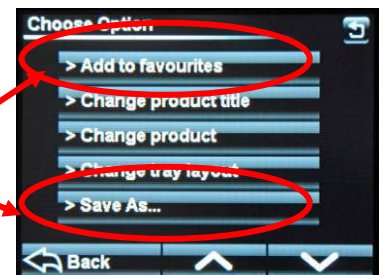

USE KEYBOARD TO TYPE THE REQUIRED
NAME AND TOUCH "SAVE"



NOTE: In manual mode, only one operation of the steam or damper is saved.

9 - 3 BAKING USING PROGRAMMES MENU

NOTE : THIS COVERS TWO VERSIONS OF FIRMWARE. (THE OVEN CAN BE PRE-SET TO SHOW ONLY ONE OF THEM).
 1. **PICTORIAL** VERSION SHOWS CHOICES OF PRODUCT CATERGORIES
 2. **NUMERICAL** VERSION SHOWS RANGES OF PROGRAM NUMBERS.

TOUCH TO OPEN
 "CATEGORY" or
 "PROGRAM CHOICE"
 SCREEN



OPTION SCREEN

TOUCH THE TYPE OF
 PRODUCT OR PROGRAM
 RANGE CHOICE WANTED
 AND "SELECT" SCREEN
 OPENS



MORE

TOUCH THE
 NAME OR NUMBER OF
 THE PRODUCT
 REQUIRED

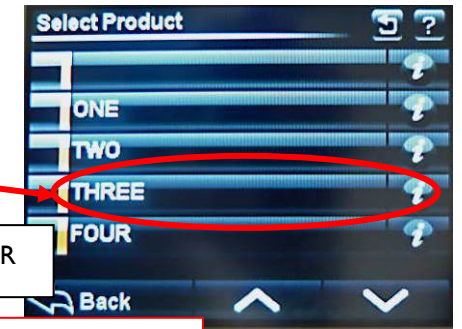
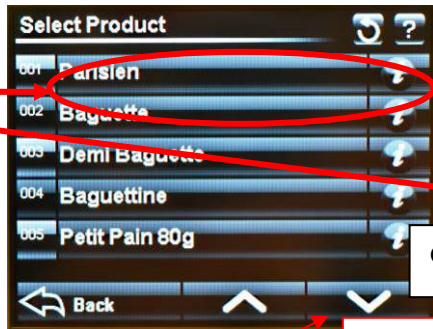

SCROLL DOWN FOR MORE PRODUCTS IF AVAILABLE

SELECT SCREEN

TOUCH THE
 "FULL LOAD" OR
 "HALF LOAD" AS
 REQUIRED



LOAD SCREEN

TOUCH THE "BACK"
 BUTTON AT ANY TIME
 TO RETURN TO THE
 PREVIOUS SCREEN

IF THE OVEN IS NOT UP TO TEMPERATURE IT WILL SHOW THE HEATING SCREEN.

WAIT FOR THE OVEN TO REACH TEMPERATURE

IF THE OVEN IS TOO HOT FOR THE TEMPERATURE CHOSEN, THE SCREEN WILL TELL YOU TO OPEN THE DOOR TO AID COOLING.

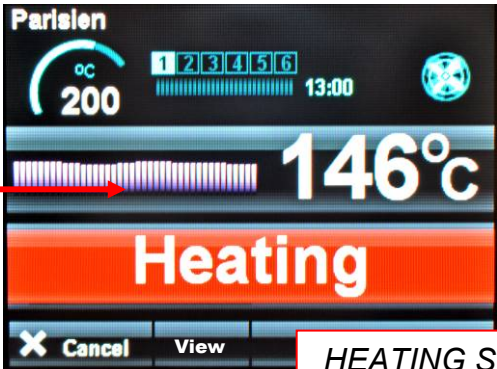

HEATING SCREEN



READY SCREEN

5

WHEN THE OVEN IS AT THE CORRECT TEMPERATURE, THE "READY" SCREEN WILL SHOW.

1. OPEN DOOR AND LOAD PRODUCT.
2. CLOSE THE DOOR FULLY.
3. TOUCH "START"

TIP
TO HELP TO KEEP THE OVEN HOT, TRY NOT TO KEEP THE DOOR OPEN MORE THAN NEEDED

THIS SCREEN WILL SHOW WHILE THE PRODUCT IS BAKING

BAKE PHASE (WHEN USED)

ACTUAL OVEN TEMPERATURE

SET TEMPERATURE

TEMPERATURE PROFILE BAR

BAKE TIME PROGRESS BAR



BAKE TIME LEFT

NOTE
The actual temperature shown will rise and fall above and below the set temperature as the oven cools and reheats. This is not a fault

BAKE OVER SCREEN



6

AT THE END OF THE BAKE TIME A SOUNDER WILL BE HEARD AND "BAKE OVER" WILL FLASH. TOUCH "STOP" AND OPEN THE DOOR TO REMOVE THE PRODUCT.

TO KEEP THE OVEN BAKING FOR EXTRA MINUTES THE "+ 10 MIN" BUTTON CAN BE TOUCHED. (THIS TIME CAN BE ALTERED IN SET UP)

TOUCHING "VIEW" BUTTON DURING BAKE

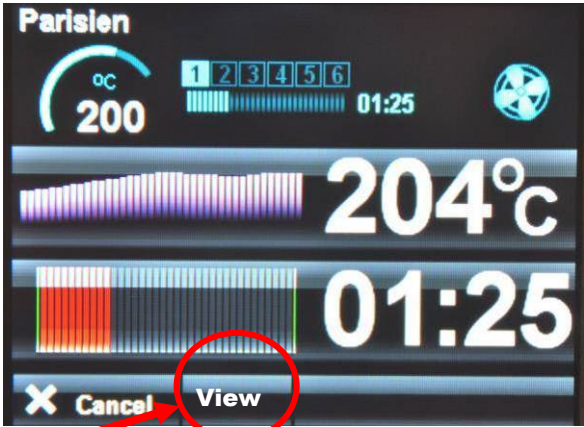

TOUCHING "VIEW" BUTTON DURING BAKE WILL SHOW THE SETTINGS FOR THE BAKE IN PROGRESS. TOUCH "CANCEL" TO GO BACK TO THE PREVIOUS SCREEN.



VIEW SCREEN

9 - 4 CREATING A PROGRAM

TOUCH TO OPEN
"CATEGORY"
SCREEN

1



OPTION SCREEN

TOUCH THE TYPE
OF PRODUCT
WANTED AND THE
"SELECT" SCREEN
OPENS

2



CATEGORY SCREEN



SELECT SCREEN

TOUCH THE DOWN ARROW
UNTIL A BLANK PROGRAM
IS REACHED.

3

TOUCH "I" BUTTON
NEXT TO THE BLANK
PROGRAM TO OPEN
NEXT SCREEN

4

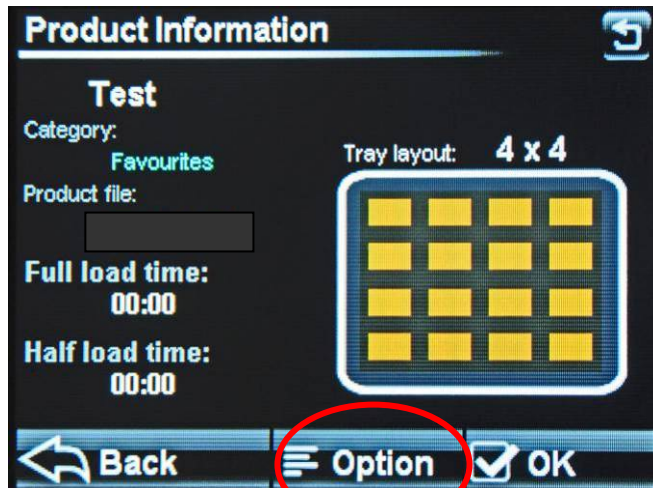

INFORMATION SCREEN

TOUCH OPTION TO GO TO
PASS CODE SCREEN

5

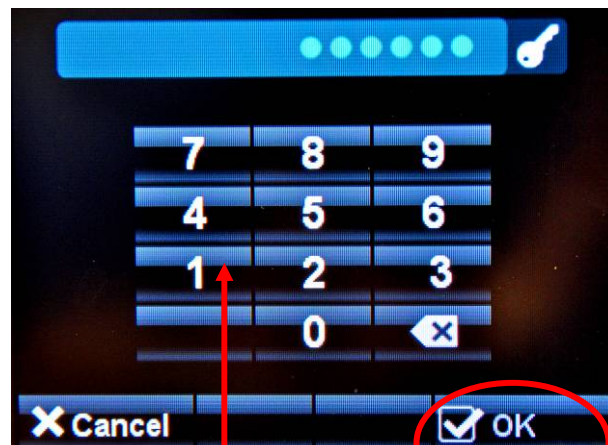

PASS CODE SCREEN

ENTER "SUPERVISOR" PASS CODE AND
THEN TOUCH OK.
(DEFAULT CODE = 123456)

6

CHANGE PRODUCT

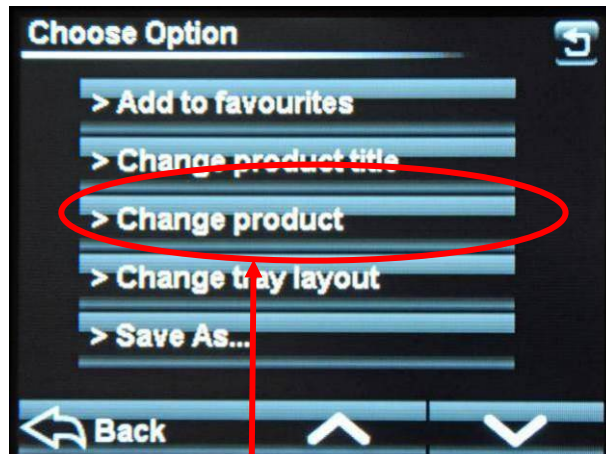

OPTION SCREEN

TOUCH "CHANGE PRODUCT"

7

LOAD TYPE

VALUE CHANGE SCREEN

Full load

1 2 3 4 5 6

BAKE PHASE (IF REQUIRED)

INCREASE

OR USE KEYS

DECREASE

ENTER AMOUNT REQUIRED AND TOUCH DONE

201

Save

POWER LEVEL

TOUCH EACH ITEM AND CHANGE THE VALUE BY USING THE UP AND DOWN KEYS OR BY USING THE KEY PAD.

TOUCH "FULL LOAD" TO CHANGE TO "HALF LOAD" SETTINGS IF REQUIRED. TOUCH AGAIN TO GO BACK TO "FULL LOAD"

TOUCH "SAVE" WHEN SATISFIED WITH THE SETTINGS OF EACH LOAD TYPE.

8

CHANGE TRAY LAYOUT

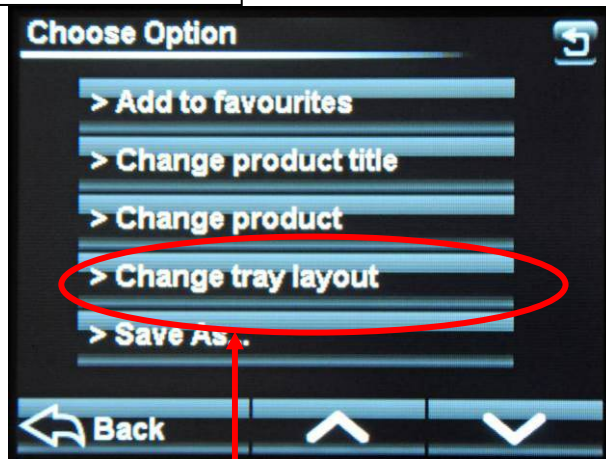

OPTION SCREEN

TOUCH "CHANGE TRAY LAYOUT"

9

TOUCH TO ADJUST
NUMBER OF PRODUCTS
ACROSS THE TRAY

TOUCH TO ADJUST
NUMBER OF PRODUCTS
DOWN THE TRAY

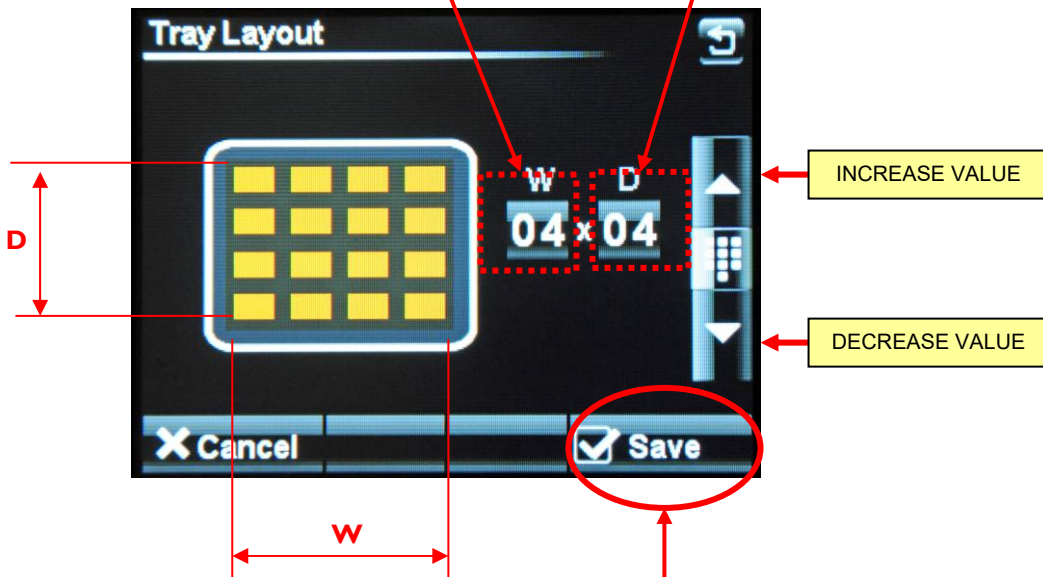

WHEN SATISFIED WITH THE TRAY
LAYOUT TOUCH SAVE TO RETURN TO
THE "OPTIONS" SCREEN

10

SAVE

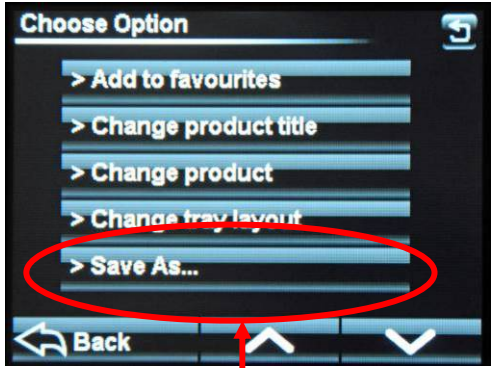

OPTION SCREEN

TOUCH "SAVE AS" 11

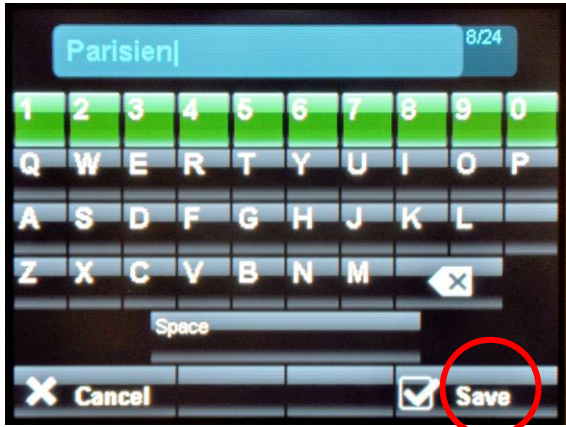

KEYBOARD SCREEN

TYPE IN THE NEW NAME AND TOUCH "SAVE" 12

ADD A PRODUCT TO THE FAVOURITES LIST

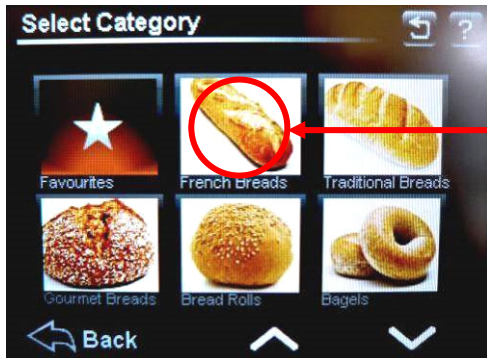

TOUCH THE TYPE OF PRODUCT WANTED AND THE "SELECT" SCREEN OPENS

1

CATEGORY SCREEN

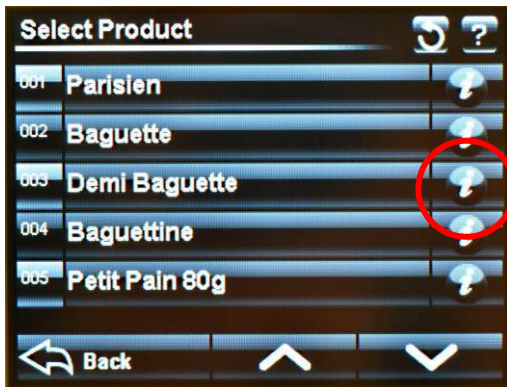

TOUCH THE "i" (INFORMATION) BUTTON NEXT TO THE PRODUCT YOU WANT AS A FAVOURITE. THIS OPENS THE OPTION SCREEN

2

SELECT SCREEN

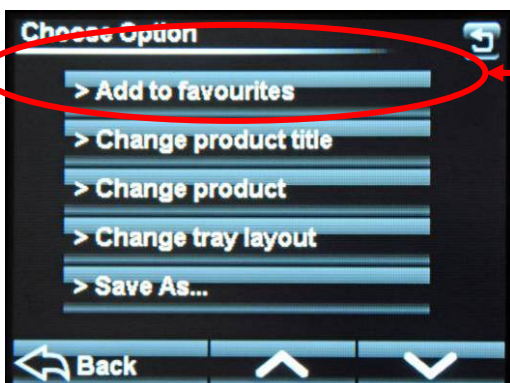

TOUCH "ADD TO FAVOURITES" THE PRODUCT WILL NOW SHOW ON THE FAVOURITES LIST

3

OPTION SCREEN

9 - 5 SETTING 7-DAY TIMER

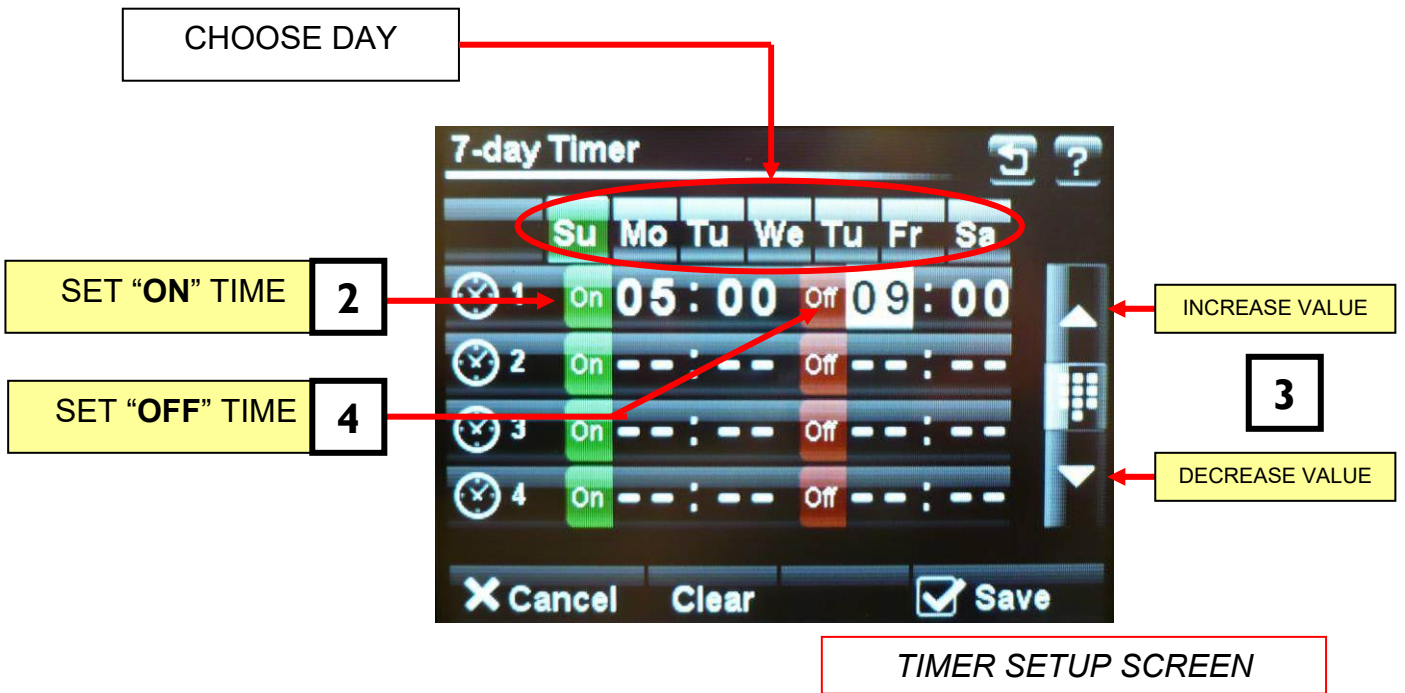

NOTE
 Up to four on/off times can be set for each day.
 Touch "clear" to clear the settings on the day shown.
 Touch "save" to activate the times set.

9 - 6 SETTINGS



TOUCH TO OPEN THE "SETTINGS" SCREEN

OPTION SCREEN



PASS CODE SCREEN

ENTER "SUPERVISOR" PASS CODE AND THEN PRESS OK. (DEFAULT CODE = 123456)

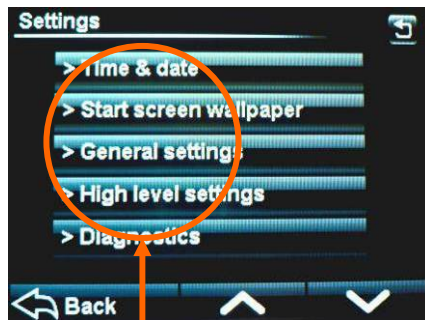

SETTINGS SCREEN

CHOOSE THE SETTING TO ALTER

TIME AND DATE

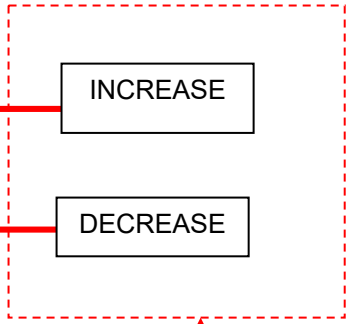
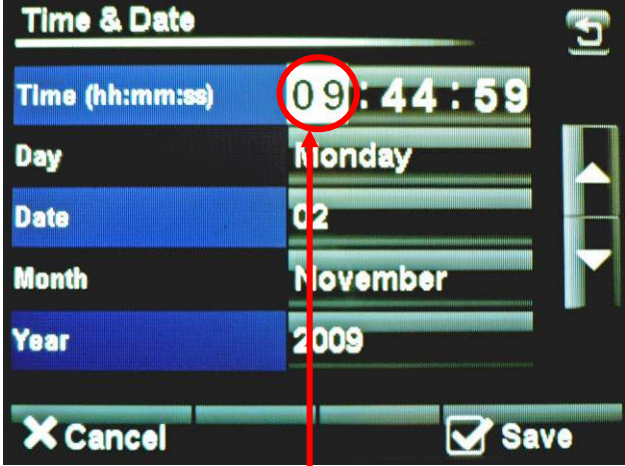

TOUCH THE SCREEN TO HIGHLIGHT THE ITEM TO CHANGE **1**

USE THE INCREASE / DECREASE BUTTONS TO ALTER THE SETTINGS **2**

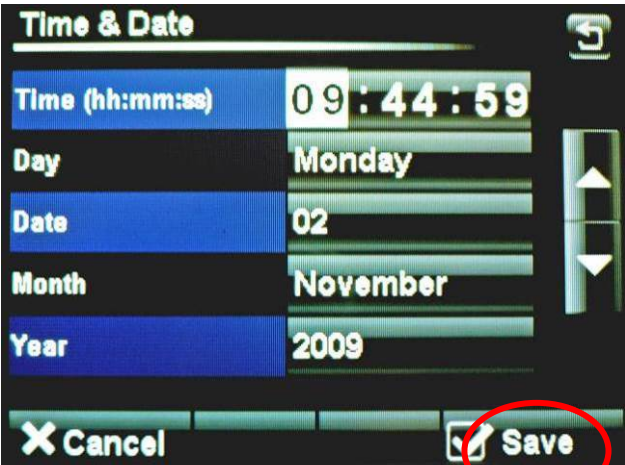

TIME AND DATE SCREEN

WHEN ALL INFORMATION IS CORRECT, TOUCH "SAVE". THIS WILL RETURN TO THE SETTINGS SCREEN **3**



SETTINGS SCREEN

OVEN SETTINGS (GENERAL)

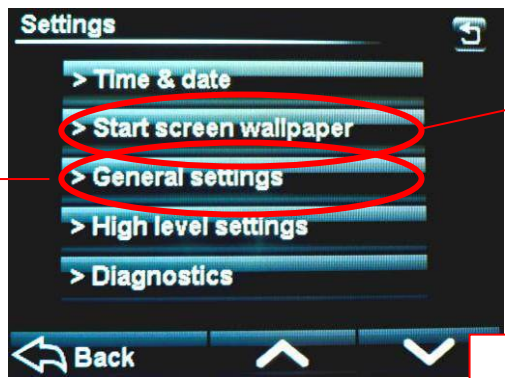

SELECT WALLPAPER.
TOUCH "BACK" TO CONFIRM

SETTINGS SCREEN

TOUCH "GENERAL SETTINGS" AND THE FOLLOWING SCREEN WILL APPEAR.
SCROLL DOWN TO MOVE THROUGH ALL CHOICES AND ADJUST EACH ONE AS REQUIRED, USING THE ARROW KEYS.

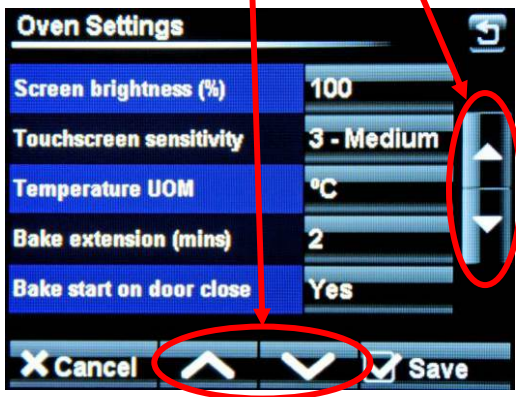

OVEN SETTINGS EXPLAINED - GENERAL LEVEL

SCREEN BRIGHTNESS –

Adjusts the brightness of the viewing screen for user comfort.

TOUCHSCREEN SENSITIVITY –

Adjusts the pressure required to operate the touch screen. (5 settings)

TEMPERATURE UNIT OF MEASURE –

Centigrade (Celsius) or Fahrenheit

BAKE EXTENSION (mins) –

Adjusts the extra time at the end of a bake for each “extra time” button touch. (10mins max)

BAKE START ON DOOR CLOSE –

This will start the set bake program as soon as the door closes.

SLEEP MODE DELAY –

Oven will go into sleep mode after the set minutes, providing it is up to temperature and has been through at least one bake cycle.

8 HOUR COUNTDOWN TIMER –

After 8 hours the oven gives a warning and then turns off.
Touch any button for an extra hour if required.

POWER LEVEL (1-4) –

Set these as required for each level to be used.

CHART INTERVAL –

Time interval in seconds that the bars show on the heat and bake time progress charts.

SOUNDER SELECT –

Set as external or onboard.

SOUNDER TONE –

Select a tone – Voice or Off

SOUNDER VOLUME –

Adjust to suit the volume required. (onboard sounder only)

SHORTCUT BUTTONS –

1 fn

2 fn

3 fn

4 fn

5 fn

<p>Gives the choice of what buttons are active and in which order they appear on the options screen. Options available = Favourites, Programs, Manual bake, Multi bake, 7-day timer . (Settings at 6fn cannot be changed)</p>
--

OVEN SETTINGS (HIGH LEVEL)

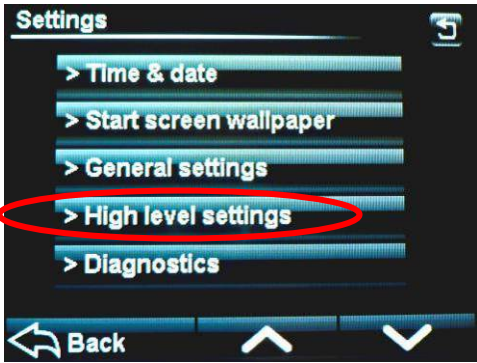

TOUCH "HIGH LEVEL SETTINGS" AND THE FOLLOWING SCREEN WILL APPEAR. **1**

SETTINGS SCREEN



ENTER "HIGH LEVEL" PASS CODE AND THEN TOUCH OK. **2**

THE FOLLOWING SCREEN WILL APPEAR.

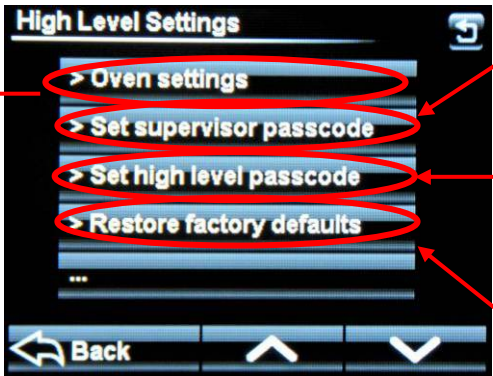

CHANGE SUPERVISOR PASSWORD HERE

CHANGE HIGH LEVEL PASSWORD HERE

RESTORES ALL SCREENS BACK TO ORIGINAL DEFAULT SETTINGS (NOT PASSCODES)

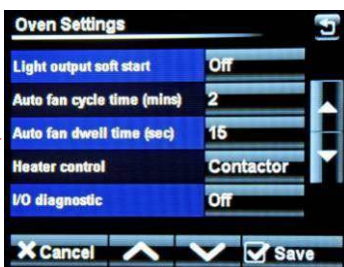
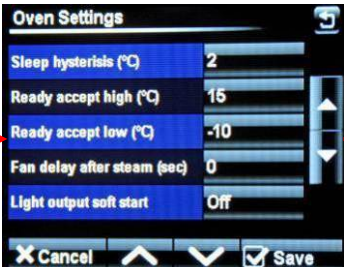
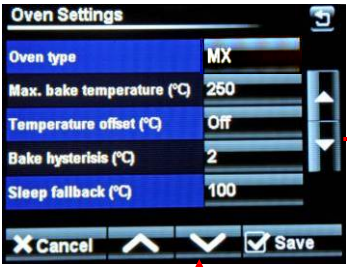

SCROLL DOWN TO MOVE THROUGH ALL CHOICES AND ADJUST EACH ONE AS REQUIRED, USING THE ARROW KEYS. **3**

OVEN SETTINGS EXPLAINED - HIGH LEVEL

OVEN TYPE –

Set this to MX.

MAX. BAKE TEMPERATURE –

Can be set up to 300C , (depending on the oven type)

TEMPERATURE OFFSET –

Can be used to adjust the display to the actual temperature in the oven.

BAKE HYSTERISIS –

Sets bake temperature cycling around a set point. (Above and below).

SLEEP FALLBACK –

Temperature of the oven in “sleep mode” (100C is suggested).

SLEEP HYSTERISIS –

Sets “sleep mode” temperature cycling around a set point. (Above and below).

READY ACCEPT HIGH –

Highest temperature for the oven to display “READY”

READY ACCEPT LOW –

Lowest temperature for the oven to display “READY”

FAN DELAY AFTER STEAM –

Delay before fan starts after the oven has steamed. (60 seconds max)

LIGHT OUTPUT SOFT START –

On/Off Some lights need this for cold start up to stop them blowing.

AUTO FAN CYCLE TIME (MINS) –

Set time required. Only used in manual and multibake modes.

AUTO FAN DWELL TIME –

Set time required. Only used in manual and multibake modes.

HEATER CONTROL –

Contact or solid state. Defaults to contactor. (solid state not used at the moment)

I/O DIAGNOSTIC –

Displays outputs and inputs at the top of the screen to aid fault finding if needed.

DEFAULT PASSCODES

SUPERVISOR (LOW LEVEL) -- 123456

HIGH LEVEL -- 654321

MASTER -- 314159 (This is fixed)

SUGGESTION

To stop unauthorised changes to the oven setup, it is suggested that this page is removed from this manual and kept in a safe place for future reference.

If tampering could be a problem, It is a good idea to change the passcodes at regular intervals,.

9 - 7 USING THE USB PORT

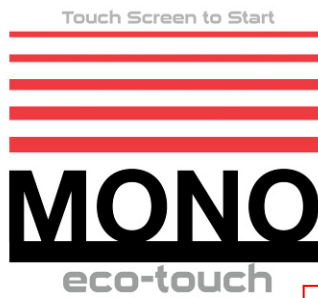

START SCREEN

Ensure the Start screen is showing **1**



Insert the USB memory stick into the socket on the oven panel. (Rubber plug may have to be removed first).

NOTE
The USB stick will only fit in one way.
Do not force into the socket.

2



Wait for the USB symbol to finish moving **3**

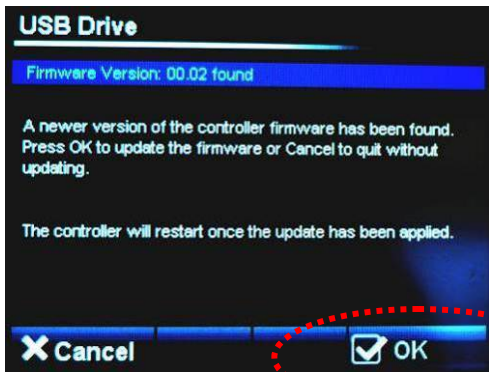

If old firmware is found, the firmware version screen will appear.

Touch "OK" to update firmware
-Wait-
Remove USB stick
OR
Touch "CANCEL" to choose other items to update or change.
(see next page)

4

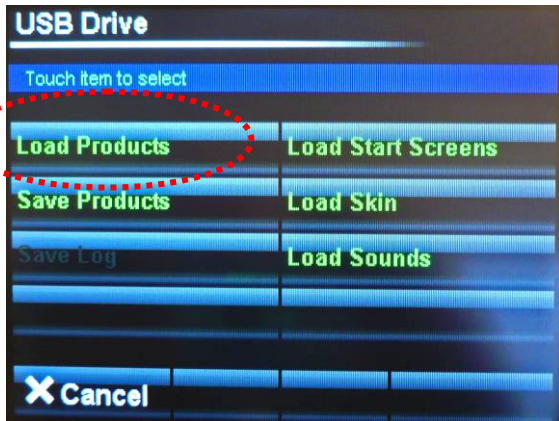

Choose action you would like to do. **5**



Select the file required. **6**



When confirmation of "file loaded ok" Shows, remove the usb stick. **7**

NOTES ON USING USB STICKS

For a USB stick to function correctly it must have the following folder in the root folder .

Mono

Then into that folder add the following:

Firmware
Products
Skins
Sounds
Start-up

Place your recipe/product files in the “**products**” folder.

The oven will find the “**Mono**” folder automatically when the stick is plugged into the oven.
Any stick can be used (does not have to be blank) but the Mono folder must be in the root folder.

The most used folders are explained below:

SKINS

These control the way the screen looks in different modes.

Pictorial is when the screen displays categories using pictures.



Numerical is when the screen displays program numbers.



STARTUP SCREENS

This is the picture/logo you see when the oven is started.



PRODUCT FILES (PROGRAM FILES)

These are the files that contain the information for baking each product e.g. bread,buns,cakes etc.

9 - 8 **DIAGNOSTICS**

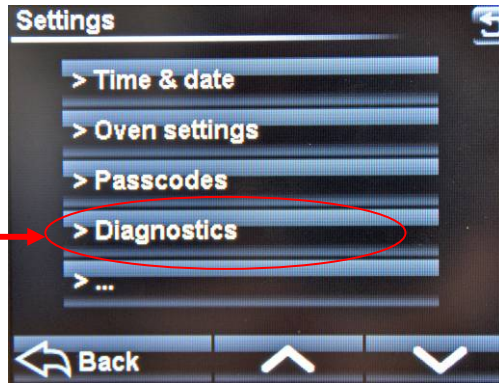

SETTINGS SCREEN

TOUCH "DIAGNOSTICS" AND THE FOLLOWING SCREEN WILL APPEAR.

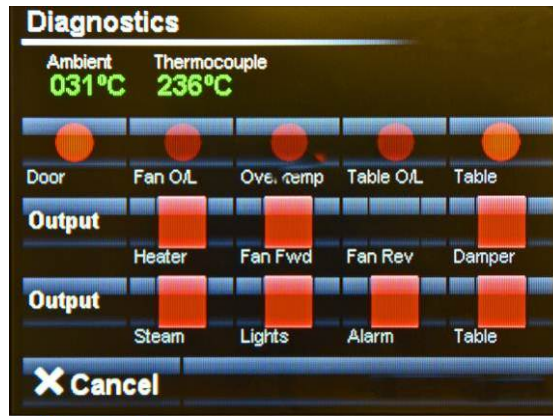

DIAGNOSTICS SCREEN

INPUTS HIGHLIGHT WHEN A SIGNAL IS Received.
e.g. DOOR OPEN

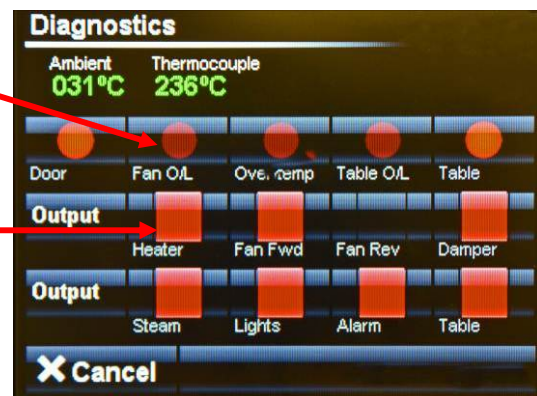

TOUCH THE REQUIRED OUTPUT AND A SIGNAL IS SENT TO THAT ITEM. THE OUTPUT BEING CHECKED IS HIGHLIGHTED WHEN ACTIVE. TO STOP THE OUTPUT, PRESS AGAIN.

10.0 TROUBLE SHOOTING

IMPORTANT!

All repairs and adjustments to the oven must be carried out by authorised experts. Isolate oven before attempting repairs or removing protective panels.

Symptom	Possible cause	Probable solution
The oven does not start, no fault shown on control panel	The main isolator switch is off.	Switch on the isolator.
	The auxiliary fuse is tripped.	Reset the fuse.
	The main fuse is tripped.	Change the fuse (before the oven).
Neither fan, hanger, steam or heat starts	Door is not closed.	Close door.
	Door switch is defective.	Replace door switch.
Rack hanger does not rotate and no fault shown on control panel	Drive belt slipping.	Check belt tension.
	Drive belt broken	Replace belt.
Oven light is not working	Light is strip is defective.	Replace the light strip.
	Faulty wiring to light.	Repair wiring.
Oven temperature fails to rise/rises slowly/ cannot be maintained during baking	No gas supply.	Check supply.
	Damper is open.	Close damper.
	Fan motor tripped.	Reset fan trip.
	Burner reset activated.	Call service engineer.
Little or no steam	Water mains disconnected or closed.	Connect water supply or open supply valve.
	Water spreader tube blocked.	Clean/unblock spreader tube.
	Filter in water line blocked.	Clean filter.
	Solenoid valve defective.	Replace solenoid valve.
Oven bakes unevenly	Air slot not adjusted correctly.	Adjust air slots. See section <i>Adjusting air slots</i> .
	Fan motor running in the wrong direction.	Switch electrical connections. Direction of rotation is indicated by arrow adjacent to motor.

Red light above control panel

Burner reset

The burner reset button is located above the control panel. After 3 failed attempts of igniting, the button will illuminate signalling that the burner has locked out.

To reset, press the button until the light goes out.

The burner will then attempt to ignite 3 more times.

If the burner continuously fails, contact a qualified gas engineer.

BURNER RESET
BUTTON



DO NOT ATTEMPT TO MAKE ADJUSTMENTS UNLESS YOU ARE FULLY AWARE OF THE RESULTS

Setting the air slots

The oven has an air panel situated in the rear right-hand corner of the baking chamber with adjustable slots, which are accurately set prior to leaving the factory (the factory settings are given in the diagram below). It is through these slots that heated air passes into the baking chamber to perform the baking task. However, external factors can negatively affect the baking result, such as a poorly designed baking programme or the combination of trays and products to be baked, and adjustment of the air slots may be necessary.

However, before making adjustments please consider the following:

- Make sure that differences in baking results are not due to differences in product batches;
- Make sure that the plates that determine the width of the air slot have not come loose thereby causing a change from the factory setting;
- Do not be too hasty in changing air slot settings in response to a sudden change in bake evenness as this may have been caused by other factors, such as, after maintenance of the oven, or a related fault with the oven. Any adjustments to the air slots would be unlikely to cure bake unevenness under these circumstances;
- Check that the air circulation fan's rotation is correct – especially after maintenance or replacement.

If it is considered that adjustments to the air slots are necessary, these should be made in small increments and one slot at a time. Measure the slot opening before adjustment then slacken the screw(s) associated with the slot that requires adjustment, adjust slot opening then retighten screw. Measure slot opening after adjustment is complete to confirm the desired dimension has been achieved.

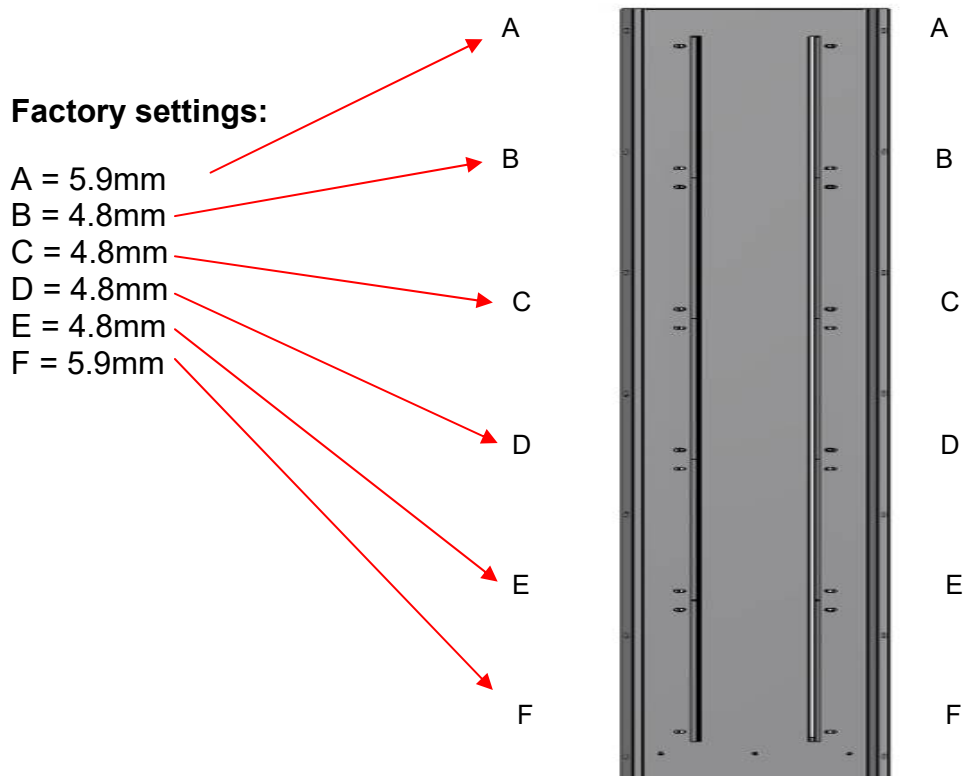

11.0 SPARES AND SERVICE ---

If a fault arises, please do not hesitate to contact the Customer Service Department, quoting the **machine serial number** on the silver information plate of the machine and on the front cover of this manual.

All correspondence must state the details shown on the oven's identification plate. *This will reduce errors and time wasted during communication.*

MONO

Queensway

Swansea West Industrial Estate

Swansea. SA5 4EB UK

email:spares@monoequip.com

Web site:www.monoequip.com

Tel. 01792 561234

Spares +44(0)1792 564039

Fax. 01792 561016



12.0 ELECTRICAL INFORMATION

IF IN ANY DOUBT - ASK 1 2 3 4 5 6 7 8

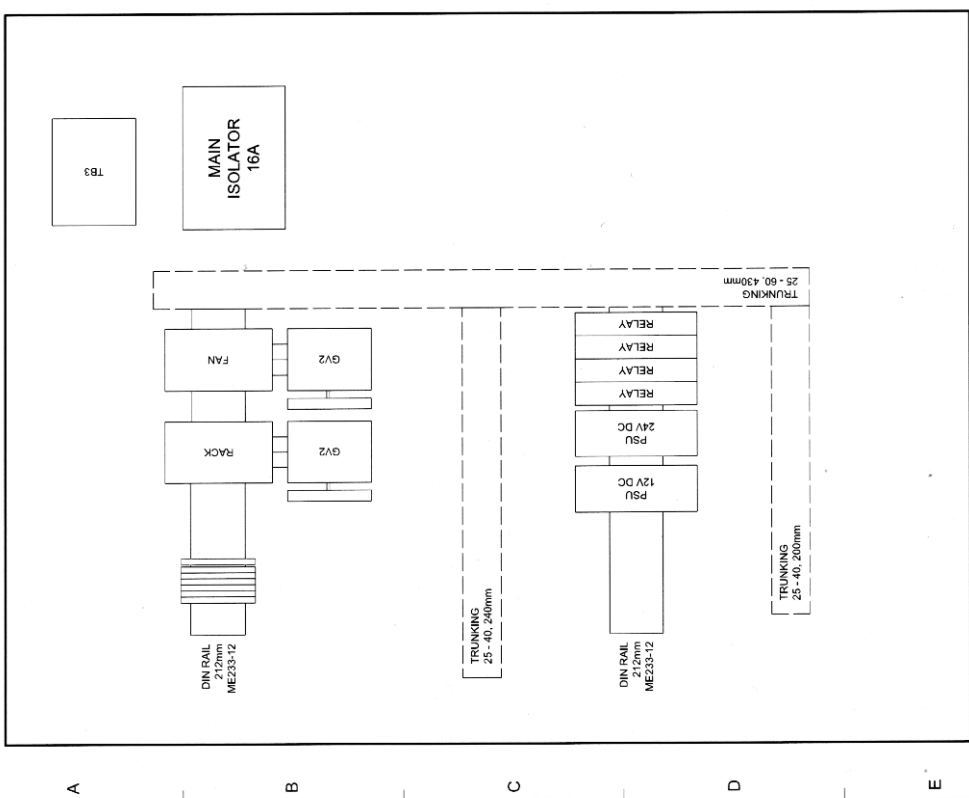

PART REFERENCE	DEVICE ID	DESCRIPTION	PART NUMBER	Mono Part Number
PT-1		Overheat Thermostat		B885-30-014
PT-6	001Q02	Main Fan Motor Auxiliary Contact	GVAN11	B872-07-006
PT-7	001Q02	Main Fan Motor Starter (GV2)	GV2MED10	B801-03-024
PT-8	001Q04	Turntable Motor Auxiliary Contact	GVAN11	B872-07-006
PT-9	001Q04	Turntable Motor Starter (GV2)	GV2MED4	B801-03-016
PT-13A		Interior Light Relay		B801-37-001
PT-14	004KM02	Main Fan Motor Contact	LC1D09BL	B801-08-031
PT-16	004KM03	Turntable Motor Contact	LC1D09BL	B801-08-031
PT-18	002L01	24V DC Power Supply	ABL1REW24025	B801-93-005
PT-19		Buzzer (Option)		B723-92-002
PT-24		Steam Solenoid		B965-83-007
PT-25		Damper Solenoid		B749-83-004
PT-26	001M01	Main Fan Motor	MONO	B912-74-035
PT-27	001M02	Turntable Motor Unit	MONO	B912-74-036
PT-28A	005L501	Turntable Index Switch Body	ZCME05	B801-11-013
PT-28B	005L501	Turntable Index Switch Head	ZC111629	B801-45-003
PT-28C	005L501	Turntable Index Switch Actuator	ZC111629	B801-45-004
PT-29	006L02	Thermocouple	MONO	B790-95-001
PT-30	005L502	Door Switch	XCM221P0L2	B801-11-001
PT-31		led light assembly		166-13-0065
PT-34	006J01	PCB Assy	MONO	198-25-90000
PT-37A		Heater Contactor Relay	Hongfa	B723-37-021
PT-38		USB Cable		B705-25-009
PT-39A		Pump Relay (If Pump Fitted)	Hongfa	B723-37-021
PT-40		Suppressor Unit (If Pump Fitted)		B842-48-010
PT-41		Water Pump (If Fitted)		A900-28-005
PT-42		Speaker		B842-92-005
PT-43	003A01	Burner Unit	Honeywell	B827-93-001
PT-44	001Q01	Isolator 16A VCCD01 3 Pole	Schneider	B801-07-007
PT-45	002A02	12V DC Power Supply	Honeywell	B782-93-002

G	12.05.2015	TD	DEVICE LIST UPDATE			
F	18.02.2015	TD	RE ROUTING OF 24VDC CONTROL			
E	12.02.2015	TD	WIRE NUMBERING MODIFICATIONS			
REV	SIG	DATE	REVISION			ECH NO.

MONO EQUIPMENT
 QUEENSWAY
 160 WILSONIA WEST IND. PARK
 SWANSEA
 SA4 4EB
 TEL: 011794 561234
 FAX: 011792 581016

TITLE: GENERAL LAYOUT
 DRAWN: TD
 DATE: 19.01.2014
 DRAWING NO.: 166E25-40000
 DRAWING SFT: B-1 Layouts 1 of 1

ELECTRICAL SPECIFICATIONS:
 ELECTRICALLY APPROVED BY:

COPYRIGHT © 1998 - THIS DESIGN/DRAWING IS THE PROPERTY OF MONO EQUIPMENT LTD. AND MUST NOT BE REPRODUCED, COPIED, NOR ITS CONTENTS DIVULGED WITHOUT PRIOR WRITTEN PERMISSION.

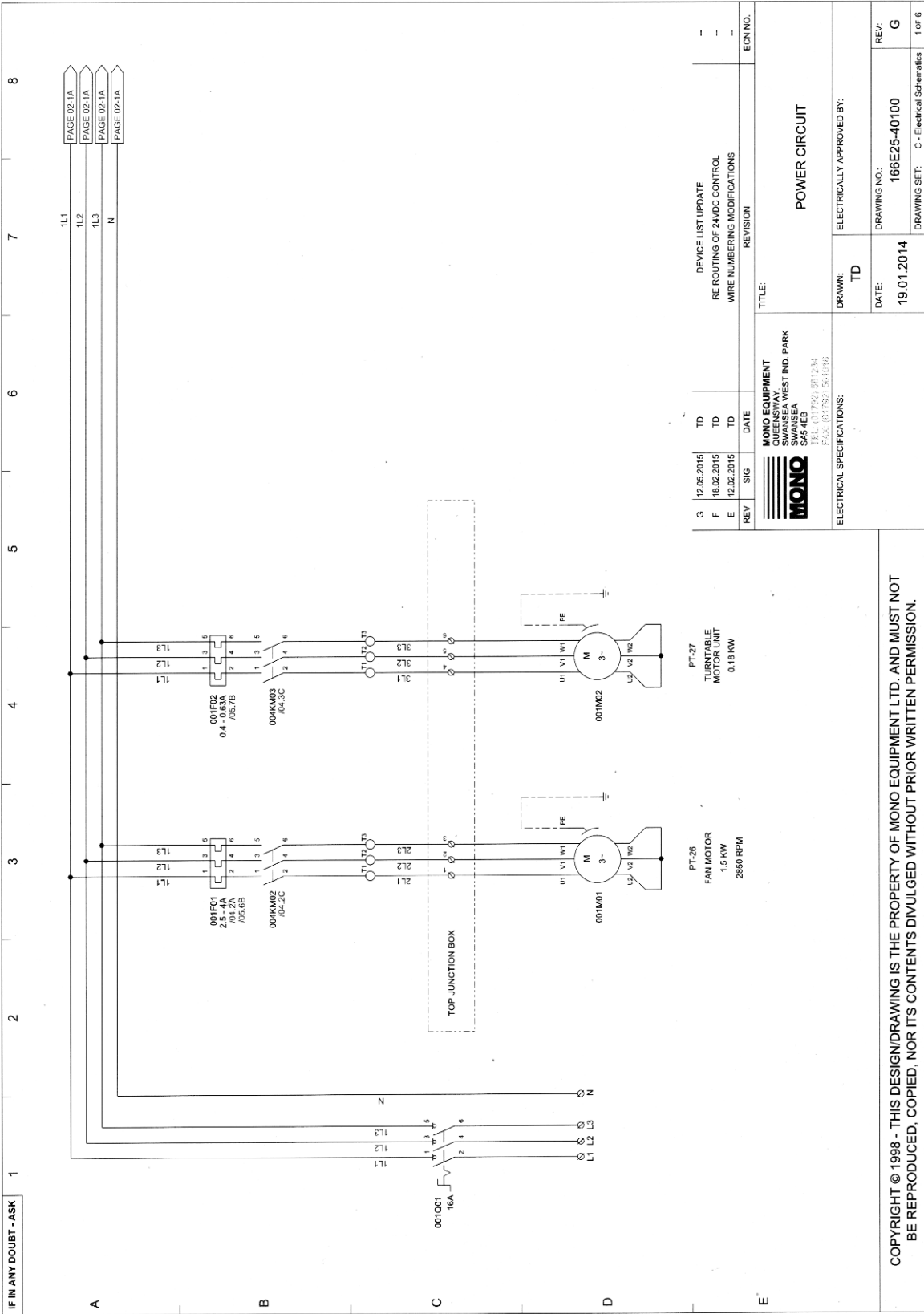

IF IN ANY DOUBT - ASK

PAGE 02-1A
PAGE 02-1A
PAGE 02-1A
PAGE 02-1A

REV	SIG	DATE	DESCRIPTION	ECN NO.
G		12.05.2015	TD	
F		18.02.2015	TD	
E		12.02.2015	TD	

DEVICE LIST UPDATE
RE ROUTING OF 24VDC CONTROL
WIRE NUMBERING MODIFICATIONS

REV	SIG	DATE	DESCRIPTION	ECN NO.
-		-	-	-
-		-	-	-

TITLE: POWER CIRCUIT

MONO EQUIPMENT
QUEENSWAY
SWANSEA WEST IND. PARK
SWANSEA
SAS 4EB
TEL: 01792 351234
FAX: 01792 354316

ELECTRICAL SPECIFICATIONS:
DRAWN: TD
DATE: 19.01.2014
DRAWING NO.: 166E25-40100
DRAWING SFT: C - Electrical Schematics

ELECTRICALLY APPROVED BY:

PT-26
FAN MOTOR
1.5 KW
2850 RPM

PT-27
TURNTABLE
MOTOR UNIT
0.18 KW

COPYRIGHT © 1998 - THIS DESIGN/DRAWING IS THE PROPERTY OF MONO EQUIPMENT LTD. AND MUST NOT BE REPRODUCED, COPIED, NOR ITS CONTENTS DIVULGED WITHOUT PRIOR WRITTEN PERMISSION.

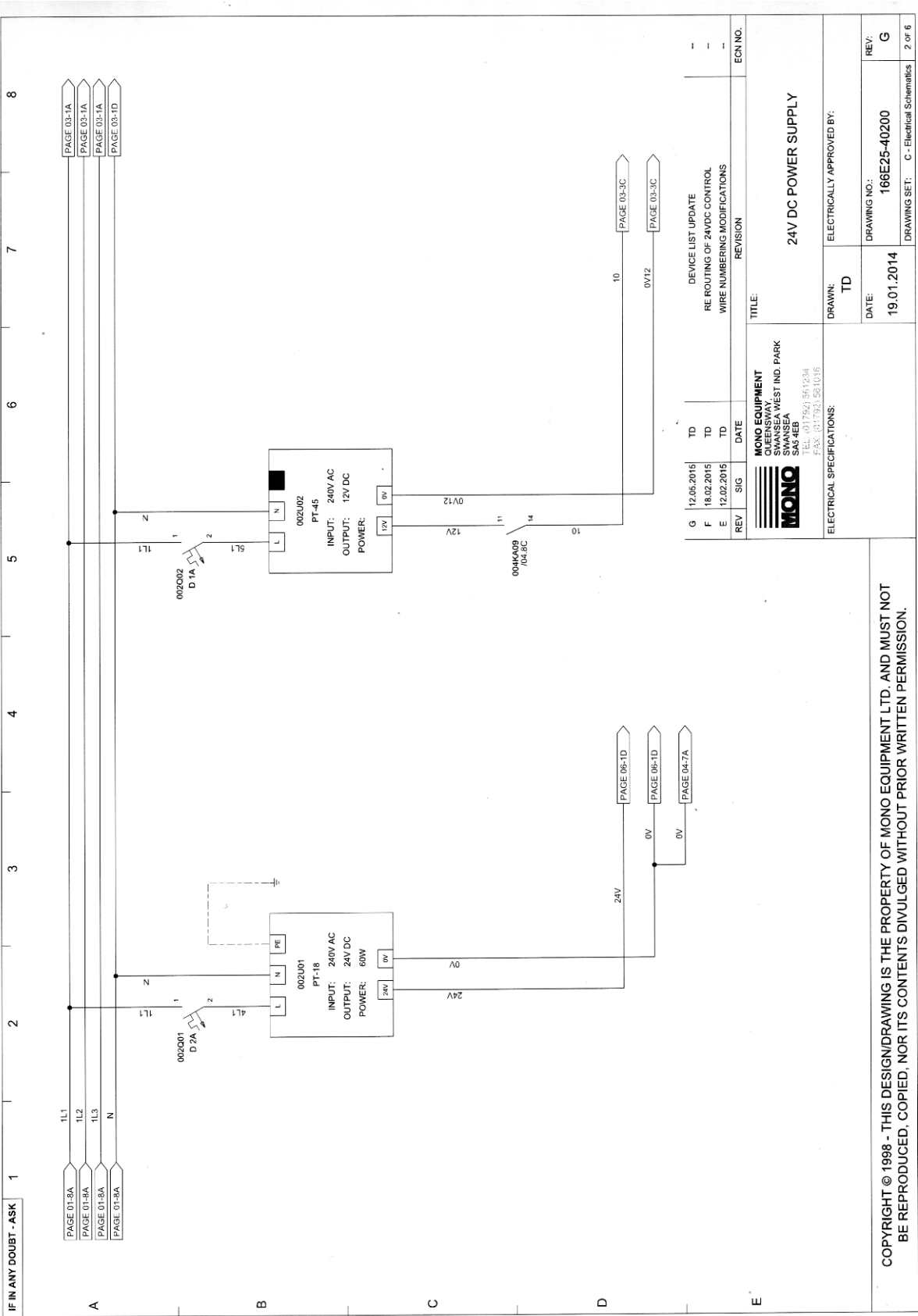

COPYRIGHT © 1998 - THIS DESIGN/DRAWING IS THE PROPERTY OF MONO EQUIPMENT LTD. AND MUST NOT BE REPRODUCED, COPIED, NOR ITS CONTENTS DIVULGED WITHOUT PRIOR WRITTEN PERMISSION.

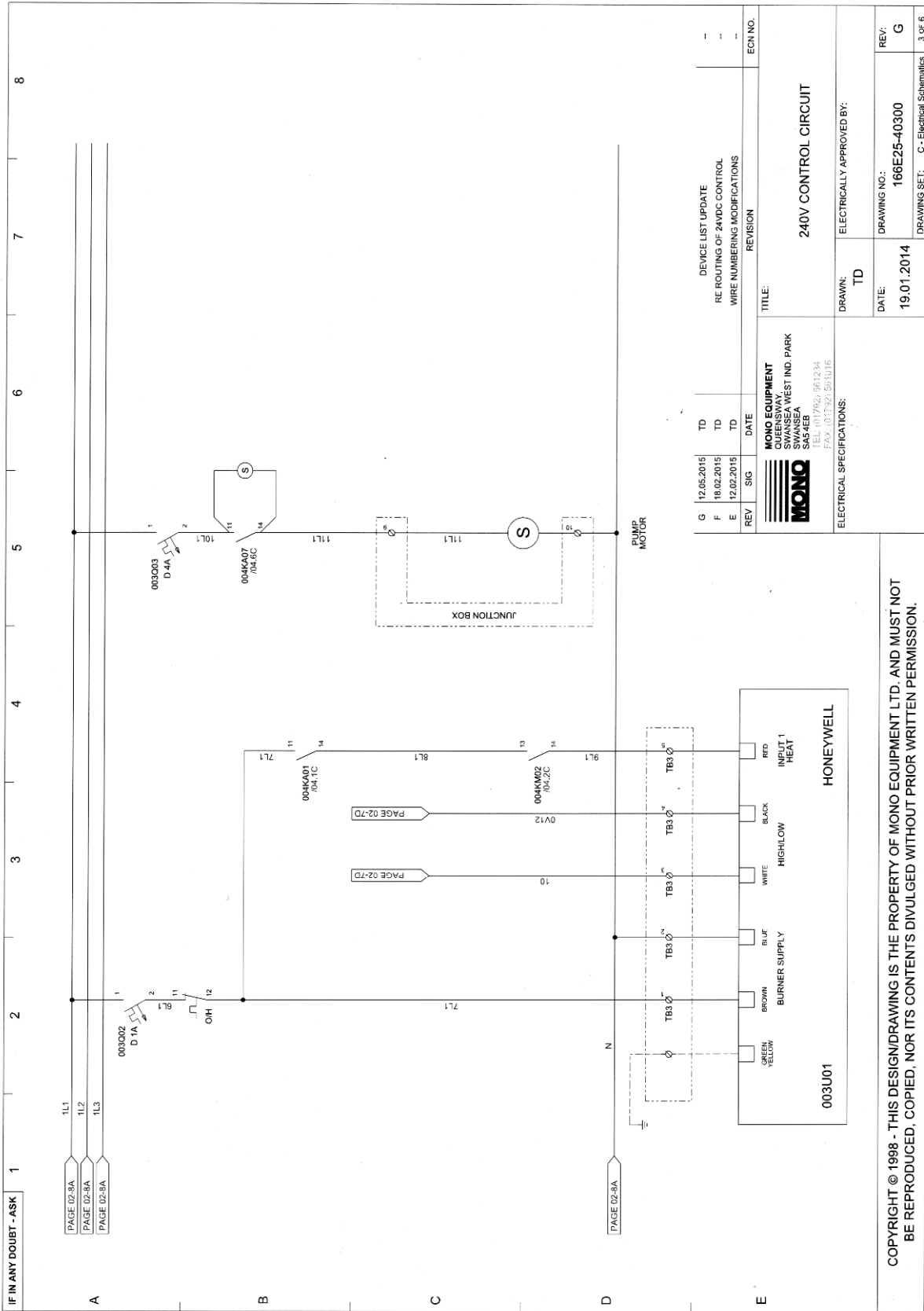

REV	SIG	DATE	DESCRIPTION	ECN NO.
G		12.05.2015	TD	
F		18.02.2015	TD	
E		12.02.2015	TD	

DEVICE LIST UPDATE
 RE ROUTING OF 24VDC CONTROL
 WIRE NUMBERING MODIFICATIONS

MONO EQUIPMENT
 CULLEN SWAY
 SWANSEA WEST IND. PARK
 SWANSEA
 SA5 4EB
 TEL: 01792 561934
 FAX: 01792 561916

TITLE: 240V CONTROL CIRCUIT
 DRAWN: TD
 ELECTRICALLY APPROVED BY:

ELECTRICAL SPECIFICATIONS:

DATE: 19.01.2014
 DRAWING NO.: 166E25-40300
 REV: G

DRAWING SET: C - Electrical Schematics
 3 of 6

COPYRIGHT © 1998 - THIS DESIGN/DRAWING IS THE PROPERTY OF MONO EQUIPMENT LTD. AND MUST NOT BE REPRODUCED, COPIED, NOR ITS CONTENTS DIVULGED WITHOUT PRIOR WRITTEN PERMISSION.

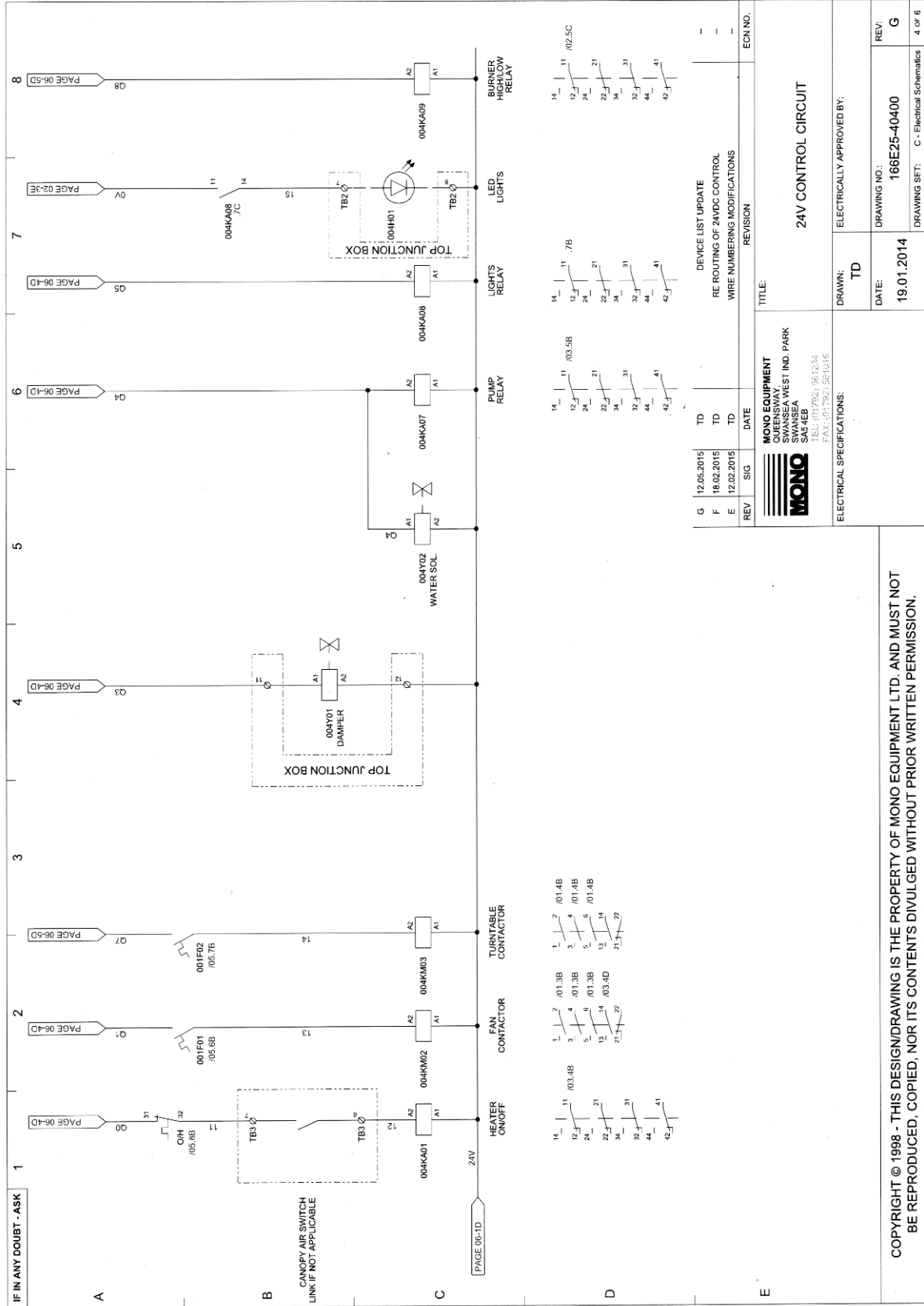

REV	SIG	DATE	DESCRIPTION	REVISION	ECH NO.
G		12.05.2015	TD	DEVICE LIST UPDATE	-
F		18.02.2015	TD	RE ROUTING OF 24VDC CONTROL	-
E		12.02.2015	TD	WIRE NUMBERING MODIFICATIONS	-

MONO EQUIPMENT QUEENSWAY SWANSEA WEST IND. PARK SWANSEA SA5 4EB TEL: 01792 561234 FAX: 01792 381315		TITLE: 24V CONTROL CIRCUIT
ELECTRICAL SPECIFICATIONS:		DRAWN: TD
ELECTRICALLY APPROVED BY:		REV: G
DATE: 19.01.2014		DRAWING NO.: 166E25-0400
DRAWING SET: C - Electrical Schematics		4 of 6

COPYRIGHT © 1998 - THIS DESIGN/DRAWING IS THE PROPERTY OF MONO EQUIPMENT LTD. AND MUST NOT BE REPRODUCED, COPIED, NOR ITS CONTENTS DIVULGED WITHOUT PRIOR WRITTEN PERMISSION.

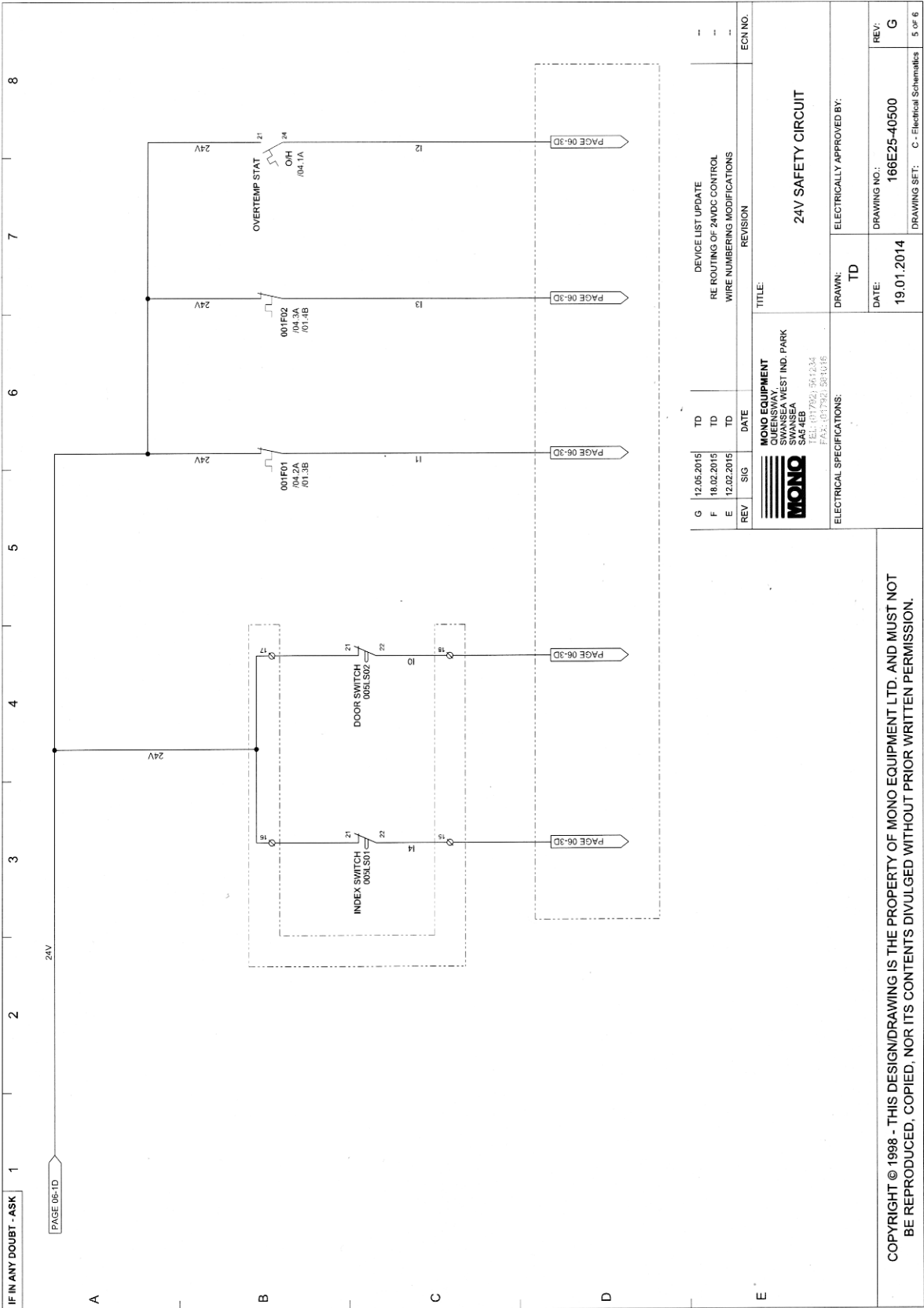

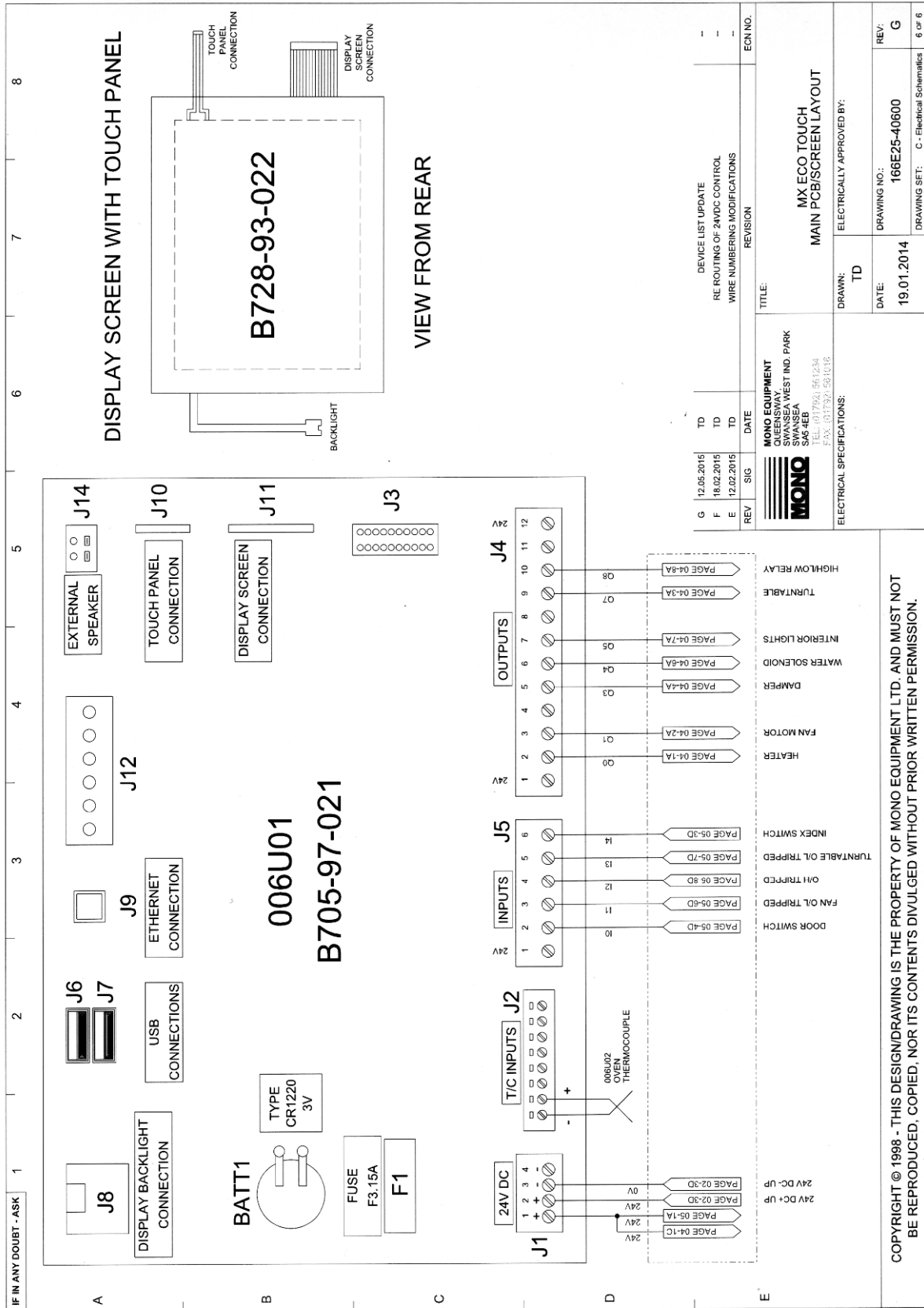



13.0 SPARES

SPARES

DESCRIPTION

PART NUMBER

Overheat thermostat	B888-30-014
Main fan motor auxiliary contact	B872-07-006
Main fan motor starter	B801-03-024
Turntable motor aux contact	B872-07-006
Turntable motor starter	B801-03-016
Interior Light relay	B801-37-001
Interior light relay base	B801-36-001
Main fan motor contactor	B801-08-031
Turntable motor contactor	B801-08-031
24v DC power supply	B801-93-005
12V DC power supply	B782-93-002
Steam solenoid	B965-83-007
Damper solenoid	B749-83-004
Main fan motor	B912-74-035
Turntable motor unit	B912-74-036
Turntable index switch body	B801-11-013
Turntable index switch head	B801-45-003
Turntable index switch actuator	B801-45-004
Thermocouple	B709-95-001
Door switch	B801-11-001
LED light assembly complete	166-13-00057
PCB Assembly	158-25-80000
Heater contactor relay	B723-37-021
USB cable	B705-25-009
Burner unit	B827-93-001
Isolator 16A 3 pole	B801-07-007
Fan drive "VEE" belt	A900-21-114
Door handle	160-32-02000
Bottom door seal	166-13-00060
Door glass unit	166-13-00035
"U" seal for glass unit	166-13-00055
Touch screen overlay	164-90-00001
Touchscreen and board	158-25-80000

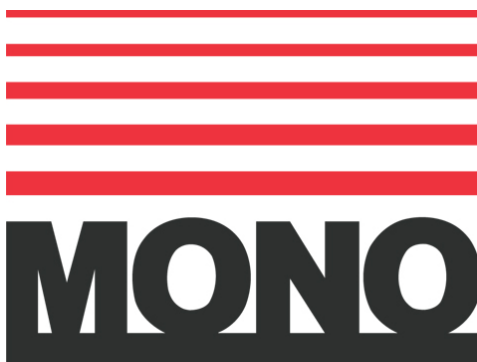

MONO

**Queensway
Swansea West Industrial Estate
Swansea. SA5 4EB UK**

**email: spares@monoequip.com
Web site: www.monoequip.com**

**Tel. 01792 561234
Spares +44(0)1792 564039
Fax. 01792 561016**